

**International
Whaling
Commission**

**Individual Recognition of Cetaceans:
Use of Photo-Identification and Other Techniques
to Estimate Population Parameters**

**INCORPORATING THE PROCEEDINGS OF THE SYMPOSIUM AND WORKSHOP ON
INDIVIDUAL RECOGNITION
AND THE ESTIMATION OF CETACEAN POPULATION PARAMETERS**

Edited by

Philip S. Hammond

*Sea Mammal Research Unit, c/o British Antarctic Survey,
Madingley Road, Cambridge, CB3 0ET, UK*

Sally A. Mizroch

*National Marine Mammal Laboratory, 7600 Sand Point Way NE, BIN C15700,
Seattle, WA 98115-0070, USA*

and Gregory P. Donovan

*The International Whaling Commission,
The Red House, Station Road, Histon, Cambridge, CB4 4NP, UK*

Series Editor

Gregory P. Donovan

**Report of the International Whaling Commission
Special Issue 12**

Cambridge 1990

**The International Whaling Commission
was constituted under the International Convention for the
Regulation of Whaling signed at Washington on 2 December 1946.**

**ISSN 0255-2760
ISBN 0 906975 23 9**

The International Whaling Commission

**The Red House, Station Road, Histon,
Cambridge CB4 4NP**

Preface

I am particularly pleased to include this volume in our Special Issue series. The Workshop and Symposium were very successful and the fruits of the contacts made there are evident in the quality of the 49 papers included here. Individual recognition techniques for cetaceans can perhaps be said to have come of age with this volume. What was perhaps not long ago seen as a 'fringe' area of cetology can now be recognised as valuable and productive in improving our knowledge of the population biology of cetaceans.

I would also here like to thank Philip Hammond, who undertook a great deal more work than is normally expected of a 'guest' editor, following the volume right through to the final stages with the printers; Marilyn K. Marx of the Center for Coastal Studies who spent a considerable amount of her time tracking down obscure references for me, always with a smile (at least on the telephone!); and finally to the staff of Black Bear Press who worked extremely hard to meet final deadlines.

G. P. DONOVAN
Series Editor

International Whaling Commission Special Issue Series

1 [1977]—Report of the Special Meeting of the Scientific Committee on Sei and Bryde's Whales.

i-v + 150 pp.; ISBN 0 906975 03 4

2 [1980]—Sperm Whales.

i-iv + 275 pp.; ISBN 0 906975 01 8

3 [1980]—Age Determination of Toothed Whales and Sirenians.

Eds W. F. Perrin and A. C. Myrick.

i-viii + 229 pp.; ISBN 0 906975 05 0

4 [1982]—Aboriginal/Subsistence Whaling (with special reference to the Alaska and Greenland Fisheries).

Ed. G. P. Donovan.

i-v + 86 pp.; ISBN 0 906975 09 3

5 [1983]—Special Issue on Historical Whaling Records.

Eds M. F. Tillman and G. P. Donovan.

i-v + 490 pp.; ISBN 0 906975 11 5

6 [1984]—Reproduction of Whales, Dolphins and Porpoises.

Eds W. F. Perrin, R. L. Brownell, Jr and D. P. DeMaster.

i-xii + 490 pp.; ISBN 0 906975 07 7

7 [1986]—Bibliography of Whales Killing Techniques.

By E. D. Mitchell, R. R. Reeves and A. Evely.

i-v + 162 pp.; ISBN 0 906975 14 X

8 [1986]—Behaviour of Whales in Relation to Management.

Ed. G. P. Donovan.

i-v + 282 pp.; ISBN 0 906975 15 8

9 [1988]—The Biology of the Genus *Cephalorhynchus*.

Eds R. L. Brownell Jr and G. P. Donovan.

i-ix + 344 pp.; ISBN 0 906975 17 4

10 [1986]—Right Whales: Past and Present Status.

Eds R. L. Brownell Jr, P. B. Best and J. H. Prescott.

i-viii + 289 pp.; ISBN 0 906975 16 6

11 [1989]—The Comprehensive Assessment of Whale Stocks: the early years.

Ed. G. P. Donovan.

i-iv + 210 pp.; ISBN 0 906975 22 0

Available from the office of the Commission, The Red House, Station Road, Histon, Cambridge CB4 4 NP, United Kingdom.

ISSN 0255-2760
ISBN 0 906975 23 9

Introduction

In June 1987, as part of its 'Comprehensive Assessment' of whale stocks (see special issue 11 in this series), the Scientific Committee recommended to the Commission that a symposium and workshop be held on the use of non-lethal techniques, especially photo-identification, to estimate cetacean population parameters. The technique of identifying individual cetaceans using unique patterns of natural markings had been pioneered in the early 1970s by workers such as Mike Bigg (killer whales), Chuck Jurasz (humpback whales) and Roger Payne (right whales). These studies had concentrated on distribution, migration, behaviour and general life history. However, it became clear that data on resightings of individuals could provide information on the abundance, survivorship, reproductive rates and population differentiation of whales which would be a valuable aid to their management. Some estimates of these population parameters had already been made, primarily for humpback, right and killer whales where long series of data existed, but it had become increasingly apparent that photo-identification was potentially a valuable tool in the study of many other cetacean species.

A major goal of the symposium and workshop was to provide a forum for discussion between researchers who were primarily field workers and those who were primarily analysts in order to develop and improve methods for data collection and estimating population parameters. Related goals were to review photographic techniques, and to discuss sampling protocols and analytical details.

In April 1988, the US National Marine Fisheries Service hosted a 2 day symposium and a 3 day workshop in La Jolla, California, chaired by J. L. Bannister. Response to the call for papers for the symposium was so great that many presentations had to be made as posters rather than talks. The subject of these presentations varied widely from descriptions of data collection and processing techniques, to highlighting problems in analysis and the calculation of estimates of population parameters. There were also a considerable number of case studies presented which encompassed species which have been the subject of photo-identification for many years and species for which this technique is a recent innovation. The papers published in this volume are grouped according to these categories. The codes ending with 'ID' and a number refer to verbal presentations (and a few papers submitted after the symposium), while those ending with 'P' and a number refer to poster presentations.

The symposium was successful in demonstrating both the extent and value of photo-identification studies throughout the world, and some of the ways in which the resulting data could be used to estimate population parameters. The presentations generated much discussion during the symposium and this was continued and developed during the workshop, the report of which is published as part of this volume. The fruits of this are revealed in the peer-reviewed published papers, which have been extensively revised in the light of these discussions.

We owe our gratitude to a number of people. D. DeMaster, S. Katona, R. Payne and G. Scott helped organise the symposium and workshop. Staff at the National Marine Mammal Laboratory, Seattle and the Southwest Fisheries Center, La Jolla assisted in symposium organisation and logistics. Particular thanks are due to the following scientists who gave a considerable amount of time to reviewing the submitted papers:

W. Amos, T. Arnbohm, S. Baker, K. Balcomb, J. Bannister, J. Barlow, P. Best, M. Bigg, J. Breiwick, R. Brownell, M. Bryden, S. Buckland, J. Calambokidis, C. Carlson, P. Clapham, C. Clarke, J. Cooke, R. Cormack, V. da Silva, R. Davis, W. de la Mare, D. DeMaster, E. Dorsey, C. Fairfield, C. Fowler, D. Gaskin, J. Geraci, D. Glockner-Ferrari, J. Gordon, J. Haldiman, J. Hall, L. Hansen, J. Harvey, A. Hiby, R. Hoelzel, H. Huber, S. Katona, G. Kirkwood, S. Kraus, S. Kruse, J. Laake, K. Lakhani, R. Lambertsen, W. Lawton, S. Leatherwood, C. Lockyer, T. Loughlin, P. Lovell, H. Marsh, A. Martin, D. Mattila, C. Mayo, R. Merrick, E. Mitchell, P. Olesiuk, J. Perkins, W. Perrin, T. Quinn, A. Raftery, S. Reilly, D. Rice, D. Rugh, O. Ryder, M. Scott, R. Sears, T. Smith, R. Wells, H. Whitehead, B. Würsig, A. York, J. Zeh.

It is also appropriate here to acknowledge the funding of the International Whaling Commission, which paid not only for 23 participants but also for the production of this volume. In particular, Martin Harvey dealt admirably with the administrative nightmare of routing money around the world in several currencies.

Finally, we would like to thank Stella Duff and Helen Coulson who typed, retyped and proof-read many of the manuscripts and typeset the tables—a soul destroying task they achieved with charm and good humour!

Philip Hammond
Sally Mizroch
Greg Donovan
Cambridge, 1990.

Contents

	<i>Page</i>
Report of the Workshop	3
Field and Laboratory Methodology	41
Würsig, B. and Jefferson, T. A. – Methods of photo-identification for small cetaceans (SC/A88/ID13)	43
Defran, R. H., Schultz, G. M. and Weller, D. W. – A technique for the photographic identification and cataloging of dorsal fins of the bottlenose dolphin (<i>Tursiops truncatus</i>) (SC/A88/P4)	53
Hiby, L. and Lovell, P. – Computer aided matching of natural markings: a prototype system for grey seals (SC/A88/ID9)	57
Mizroch, S. A., Beard, J. A. and Lynde, M. – Computer assisted photo-identification of humpback whales (SC/A88/ID11)	63
Whitehead, H. – Computer assisted individual identification of sperm whale flukes (SC/A88/ID42)	71
Amos, B. and Hoelzel, A. R. – DNA fingerprinting cetacean biopsy samples for individual identification (SC/A88/ID29)	79
Yochem, P. K., Stewart, B. S., Mina, M., Zorin, A., Sadovov, V. and Yablokov, A. – Non-metrical analyses of pelage patterns in demographic studies of harbor seals (SC/A88/P24)	87
Analytical Problems	91
Bain, D. – Examining the validity of inferences drawn from photo-identification data, with special reference to studies of the killer whale (<i>Orcinus orca</i>) in British Columbia (SC/A88/ID33)	93
Hansen, L. J. and Defran, R. H. – A comparison of photo-identification studies of California coastal bottlenose dolphins (SC/A88/P8)	101
Carlson, C. A., Mayo, C. A. and Whitehead, H. – Changes in the ventral fluke pattern of the humpback whale (<i>Megaptera novaeangliae</i>), and its effect on matching; evaluation of its significance to photo-identification research (SC/A88/ID35)	105
Lockyer, C. H. and Morris, R. J. – Some observations on wound healing and persistence of scars in <i>Tursiops truncatus</i> (SC/A88/P16)	113
Fairfield, C. P. – Comparison of abundance estimation techniques for the western North Atlantic right whale (<i>Eubalaena glacialis</i>) (SC/A88/ID37)	119
Stern, J. S., Dorsey, E. M. and Case, V. L. – Photographic catchability of individually identified minke whales (<i>Balaenoptera acutorostrata</i>) of the San Juan Islands, Washington and the Monterey Bay Area, California (SC/A88/ID34)	127
Hammond, P. S. – Heterogeneity in the Gulf of Maine? Estimating humpback whale population size when capture probabilities are not equal (SC/A88/ID4)	135
Hammond, P. S., Sears, R. and Bérubé, M. – A note on problems in estimating the number of blue whales in the Gulf of St. Lawrence from photo-identification data (SC/A88/ID44)	141
Gunnlaugsson, T. and Sigurjónsson, J. – A note on the problem of false positives in the use of natural marking data for abundance estimation (SC/A88/ID46)	143
Population Parameters, Dynamics and Behaviour	147
Buckland, S. T. – Estimation of survival rates from sightings of individually identifiable whales (SC/A88/ID5) ..	149
Barlow, J. – A birth-interval model for estimating cetacean reproductive rates from resighting data (SC/A88/ID6) ..	155

Glockner-Ferrari, D. A. and Ferrari, M. J. – Reproduction in the humpback whale (<i>Megaptera novaeangliae</i>) in Hawaiian waters, 1975–1988: the life history, reproductive rates, and behaviour of known individuals identified through surface and underwater photography (SC/A88/ID30)	161
Clapham, P. J. and Mayo, C. A. – Reproduction of humpback whales (<i>Megaptera novaeangliae</i>) observed in the Gulf of Maine (SC/A88/ID31)	171
Jones, M-L. – The reproductive cycle in gray whales based on photographic resightings of females in the breeding grounds from 1977–82 (SC/A88/ID38)	177
Best, P. B. and Underhill, L. G. – Estimating population size in southern right whales (<i>Eubalaena australis</i>) using naturally marked animals (SC/A88/ID16)	183
Alvarez, C. F., Aguayo, A. L., Rueda, R. R. and Urbán, J. R. – A note on the stock size of humpback whales along the Pacific coast of Mexico (SC/A88/ID27)	191
Weigle, B. – Abundance, distribution and movements of bottlenose dolphins (<i>Tursiops truncatus</i>) in Lower Tampa Bay, Florida (SC/A88/P22)	195
Hamilton, P. K. and Mayo, C. A. – Population characteristics of right whales (<i>Eubalaena glacialis</i>) observed in Cape Cod and Massachusetts Bays, 1978–1986 (SC/A88/ID18)	203
Olesiuk, P. K., Bigg, M. A. and Ellis, G. M. – Life history and population dynamics of resident killer whales (<i>Orcinus orca</i>) in the coastal waters of British Columbia and Washington State (SC/A88/ID3)	209
Morton, A. B. – A quantitative comparison of the behaviour of resident and transient forms of the killer whale off the central British Columbia coast (SC/A88/P17)	245
Whitehead, H. and Waters, S. – Social organisation and population structure of sperm whales off the Galápagos Islands, Ecuador (1985 and 1987) (SC/A88/ID45)	249
Shane, S. H. and McSweeney, D. – Using photo-identification to study pilot whale social organization (SC/A88/P20)	259
Kaufman, G. D., Osmond, M. G., Ward, A. J. and Forestell, P. H. – Photographic documentation of the migratory movement of a humpback whale (<i>Megaptera novaeangliae</i>) between East Australia and Antarctic Area V (SC/A88/ID41)	265
Case Studies (by species)	269
Payne, R., Rowntree, V., Perkins, J. S., Cooke, J. G. and Lankester, K. – Population size, trends and reproductive parameters of right whales (<i>Eubalaena australis</i>) off Peninsula Valdes, Argentina (SC/A88/ID1)	271
Bannister, J. – Southern right whales off western Australia (SC/A88/ID17)	279
Rugh, D. J. – Bowhead whales reidentified through aerial photography near Point Barrow, Alaska (SC/A88/ID15)	289
Katona, S. K. and Beard, J. A. – Population size, migrations and feeding aggregations of the humpback whale (<i>Megaptera novaeangliae</i>) in the western North Atlantic Ocean (SC/A88/ID2)	295
Perry, A., Baker, C. S. and Herman, L. M. – Population characteristics of individually identified humpback whales in the central and eastern North Pacific: a summary and critique (SC/A88/ID25)	307
Straley, J. M. – Fall and winter occurrence of humpback whales (<i>Megaptera novaeangliae</i>) in southeastern Alaska (SC/A88/ID26)	319
Calambokidis, J., Cubbage, J. C., Steiger, G. H., Balcomb, K. C. and Bloedel, P. – Population estimates of humpback whales in the Gulf of the Farallones, California (SC/A88/ID36)	325
Sears, R., Williamson, J. M., Wenzel, F. W., Bérubé, M., Gendron, D. and Jones, P. – Photographic identification of the blue whale (<i>Balaenoptera musculus</i>) in the Gulf of St. Lawrence, Canada (SC/A88/ID23)	335
Calambokidis, J., Steiger, G. H., Cubbage, J. C., Balcomb, K. C., Ewald, C., Kruse, S., Wells, R. and Sears, R. – Sightings and movements of blue whales off central California 1986–88 from photo-identification of individuals (SC/A88/ID24)	343

CONTENTS

Agler, B. A., Beard, J. A., Bowman, R. S., Corbett, H. D., Frohock, S. W., Hawvermale, M. P., Katona, S. K., Sadove, S. S. and Seipt, I. E. – Fin whale (<i>Balaenoptera physalus</i>) photographic identification: methodology and preliminary results from the western North Atlantic (SC/A88/20)	349
Dorsey, E. M., Stern, S. J. Hoelzel, A. R. and Jacobsen, J. – Minke whales (<i>Balaenoptera acutorostrata</i>) from the west coast of North America: individual recognition and small-scale site fidelity (SC/A88/ID21)	357
Tershy, B. R., Breese, D. and Strong, C. S. – Abundance, seasonal distribution and population composition of balaenopterid whales in the Canal de Ballenas, Gulf of California, Mexico (SC/A88/ID22)	349
Whitehead, H. – Assessing sperm whale populations using natural markings: recent progress (SC/A88/ID7)	377
Bigg, M. A., Olesiuk, P. F., Ellis, G. M., Ford, J. K. B. and Balcomb, K. C. – Social organization and genealogy of resident killer whales (<i>Orcinus orca</i>) in the coastal waters of British Columbia and Washington State (SC/A88/ID39)	383
Wells, R. S. and Scott, M. D. – Estimating bottlenose dolphin population parameters from individual identification and capture-release techniques (SC/A88/P23)	407
Preliminary/Feasibility Studies	417
Joyce, G. G. and Dorsey, E. M. – A feasibility study on the use of photo-identification techniques for Southern Hemisphere minke whale stock assessment (SC/A88/ID43)	419
Miyashita, T., Kasuya, T. and Mori, K. – An examination of the feasibility of using photo-identification techniques for a short-finned pilot whale stock off Japan (SC/A88/P14)	425
Miller, E. – Photo-identification techniques applied to Dall’s porpoise (<i>Phocoenoides dalli</i>) in Puget Sound, Washington (SC/A88/P13)	429
Yuanyu, H., Xianfeng, Z., Zhuo, W. and Xiaoqiang, W. – A note on the feasibility of using photo-identification techniques to study the Baiji (<i>Lipotes vexillifer</i>) (SC/A88/P25)	439

Report of the Workshop



Humpback whale, West Greenland, courtesy Finn Larsen.

Report of the Workshop on Individual Recognition and the Estimation of Cetacean Population Parameters

The meeting was held at the Southwest Fisheries Center, La Jolla, California, from 1-4 May 1988. A list of participants is given in Annex A.

1-5 INTRODUCTION

At its 1987 meeting, the Scientific Committee had recommended that a Workshop be held, as part of the IWC's Comprehensive Assessment, to address the question of the use of natural markings to estimate population parameters (IWC, 1988, p.132-3).

A steering group comprising Mizroch (Convenor), Donovan, Katona, Hammond and Payne was appointed to plan the meeting. DeMaster and Scott were added subsequently. The Workshop was preceded by a Symposium held under the auspices of the IWC at Scripps Institute of Oceanography from 29 April to 4 May. In addition to the Workshop participants, all of whom took an active part in the Symposium, a wider audience of some 200 persons attended the Symposium. Most of the papers referenced in this report were presented in verbal or poster form at the Symposium.

The Scientific Committee had noted the successful use of photo-identification techniques on species such as humpback and right whales. It noted that it is particularly important to evaluate the method for species with apparently subtle markings, and where the populations may be large and primarily pelagic. It is also important to evaluate sample size requirements for population estimates of various levels of precision.

A major goal of the Workshop was to provide a forum for exchange of expertise between researchers who are primarily field workers and those who are primarily analysts, in order to develop and improve methods for estimating population parameters based on photo-identification of individuals. Additional goals were to allow the sharing of information on coding, photographic and matching techniques, to develop common terms of reference, and to evaluate current and likely levels of precision of population parameters estimated from such data.

Bannister was elected chairman. Donovan agreed to act as rapporteur assisted by Hammond, Hoelzel, Barlow, Buckland, Katona and Best. He also carried out the final editing of the report.

The Agenda adopted is shown as Annex B and the list of documents and posters available at the symposium is given in Annex C.

6. INDIVIDUAL RECOGNITION

6.1 DNA fingerprinting

The genomic components useful for individual identification and the mechanisms that generate high levels of variation in those regions are described in detail in Hoelzel and Dover (1989). The process of 'DNA fingerprinting' (Jeffreys, Wilson and Thein, 1985) utilises these hypervariable sequences to create a series of bands that is specific to individuals. Whole DNA is digested with

an appropriate restriction enzyme, run electrophoretically on an agarose gel, blotted and probed with a radioactively labelled sequence of the 'mini-satellite' region described by Jeffreys *et al.* (1985) or another similar sequence (see Hoelzel and Dover, 1989). Typically most fragments identified by this procedure will be rare in the population, with a few being more common.

Fragments that migrate the same distance on a gel can be treated as the same allele for the purposes of this estimation and their frequency in the population given by q . Jeffreys *et al.* (1985) note that the probability, x , that a fragment in individual A is present in individual B is related to the allele frequency q by:

$$x = 2q - q^2$$

If there is an average of n variable fragments per fingerprint, then the mean probability that all the fragments in individual A are also present in an unrelated individual B can be estimated by x^n . This is a maximum estimate of the probability of a mis-match. SC/A88/ID29 determined this probability to be about 1.5×10^{-5} for a sample of 13 fin whales using just one probe. The use of additional probes and the investigation of a larger sample will reduce this probability.

While it may be difficult to distinguish all individuals photographically in some species, biopsy sampling and subsequent DNA fingerprinting can uniquely identify all individuals sampled. However, it is likely to take more time and effort to collect biopsy samples than photographs (see SC/A88/ID29).

6.2. Photographs of natural markings

The use of photographic techniques to identify individuals from their natural markings has been well-established for a number of cetacean species, e.g. right, humpback and killer whales. Table 1 summarises the current extent of such studies by species. The Workshop discussed the degree to which these techniques could be applied to populations of interest to the Commission which are not currently under study. Annex D describes the results of an exercise undertaken at the Workshop to estimate approximate sample sizes necessary to obtain estimates of fin and minke whale populations of different sizes. These estimates indicate how feasible it might be to conduct photo-identification studies on these populations for assessment purposes. This question is addressed further in SC/A88/ID43.

6.3. Acoustic 'techniques'

Several workers (e.g. Clark, 1989) have begun to examine the potential of examining 'voiceprints' to identify individuals of various species including bowhead, sperm and killer whales. So far these studies have proved inconclusive but the existence of mimicry and the need for factor analysis suggests that such techniques (i.e. in the context of identifying individuals) are not likely to be useful in estimating population parameters in the near future, if at all.

Table 1

Summary of photo-identification effort on cetaceans, 1988. Only a selection of the studies on small cetaceans are presented here. For further information see Würsig and Jefferson, Paper SC/A88/ID13, published in this volume.

Primary Character (Secondary)	Area	Platform	Years	Custodian	Contributors	Approx cat. size
Right whales						
<i>North Atlantic</i>						
Callosities (Scars, birthmarks, lip crenulations)	N.W. Atlantic	Vessels, aircraft	1959-88 (esp. from 1980)	New England Aquarium	1-9	257
<i>Southern Hemisphere</i>						
Callosities (body markings)	W. Australia	Aircraft	1967-88	J.L. Bannister		250
Callosities (body markings)	S. Australia	Aircraft	1987-88	J.K. Ling		4
Callosities (body markings)	S. Africa	Helicopter	1979-87	P.B. Best		280
Callosities (body markings)	Tristan da Cunha, Gough Island	Helicopter, shore	1983-85	P.B. Best		10
Callosities (body markings, scars)	Argentina (& Brazil)	Aircraft (shore boats)	1970-87	R. Payne	10-16	850
Callosities (body markings, scars)	St Catarina, Brazil	Aircraft	1987	J.T. Palazo		30
Callosities	New Zealand, Campbell Island	Shore, ships, aircraft	1982-88	M.W. Cawthorn	79-80	180
Bowhead whales						
Dorsal pigmentation	N. Bering, Chukchi and Beaufort Seas	Aircraft	1976-87	National Marine Mammal Laboratory	17-20	1,400
Blue whales						
<i>Indian Ocean</i>						
Flukes, pigmentation, scars	Sri Lanka (NE coast)	Sailboat	1983-84	E. Dorsey	21-24	32
<i>North Pacific</i>						
Body pigmentation	California, Mexico	Vessel	1983-88	Cascadia Research Collective	25-28	220
Mottling on back and flanks (ventral fluke pattern, scars)	Sea of Cortez	Small boats	1981-88	Mingan Island Cetacean study		92
<i>North Atlantic</i>						
Mottling on back and flanks (ventral fluke pattern, scars)	Gulf of St Lawrence	Small boats	1979-88	Mingan Island Cetacean study	2,29-30	196
Fin whales						
<i>North Atlantic</i>						
Dorsal fin, pigmentation patterns (body scars)	NW Atlantic	Vessels	1974-88	College of the Atlantic	2,6,8,23, 30-36 (+ 300 to be catalogued)	200
<i>North Pacific</i>						
Dorsal fin	Gulf of California, Mexico & EN Pacific	Small boats	1982-86	B. Tershy, D. Breese	81-87	149
Sei whales						
<i>North Atlantic</i>						
Dorsal fin, scars	S. Gulf of Maine	Vessels	1986-88	Center for Coastal Studies, Cetacean res.unit, Gloucester		60
Bryde's whales						
<i>North Pacific</i>						
Dorsal fin	Gulf of California Mexico & E.N. Pacific	Small boats	1982-86	B. Tershy, D. Breese	81-87	160
<i>S. Hemisphere</i>						
Dorsal fin	S. Africa	Ship	1983	P.B. Best		50
Minke whales						
<i>North Pacific</i>						
Dorsal fins, scars, body pigment	San Juan Islands, Washington	Small boats	1977-87	E. Dorsey	37-39,24	30
Dorsal fins, scars, body pigment	Monterey Bay, California	Small boats	1984-87	J. Stern	38	17
Dorsal fins, scars, body pigment	Johnstone Strait, B.C.	Small boats	1981-86	E. Dorsey	37, 40	7
Dorsal fin	Gulf of California	Small boats	1982-86	B. Tershy, D. Breese	41-42	6

Cont.

Primary Character (Secondary)	Area	Platform	Years	Custodian	Contributors	Approx cat. size
Gray whales						
Pigmentation, scarring	Washington State	Small boats, aircraft	1985-86	Cascadia Res. Collective		10
Pigmentation, scars on back	Baja: San Ignacio	Small boats	1977-82	M.L. Jones		434
			1983-87	M.L. Jones(occasional)		75
Pigmentation, scars on back	Baja: Guerro Negro	Small boats	1980-82	P.J. Bryant		403-701 ^a
Pigmentation, scars on back	Baja: Ojo de Liebre	Small boats	1980-81	National Marine Mammal Lab.		56-112 ^a
Pigmentation, scars on back	Baja: Bahia Magdalena	Small boats	1984-87	L.Fleischer		?
Pigmentation, scars on back	Baja: Bahia Magdalena	Small boats	1982	S. Lawson (UC Irvine)		200
Pigmentation, scars on back	Canada: Vancouver	Small boats	1975-?	J. Darling		?
Pigmentation, scars on back	Mexico: Yavarros & Bahia Reforma	Small boats	1980-82	L. Findley, O. Vidal		?
Humpback whales						
<i>North Pacific</i>						
Flukes	Mexico	Small boats	1986-88	Centre for Whale Research Friday Harbor		50
Body patterns (dorsal fins, pigmentation, lip grooves)	Hawaii	Small boats, divers	1975-88	Centre for Whale Studies, Hawaii	77-78	583 ads 268 calves
Flukes	Hawaii	Small boats	1975-88	Centre for Whale Studies, Hawaii	77-78	210 ads 2 calves
Flukes	Isla Gorgona, Colombia	Small boats	1986-87	L.F. Constain		<100
Flukes, dorsal fins	Hawaii, S.E. Alaska	Small boats	1977-88	Kewalo Basin Marine Mamm. Lab	43-50	1200-1400
Flukes	Mexico	Small boats	1982-88	Urban, UABCS; Aguayo, UNAM	18,40-42 57,67-68	350-400
Flukes	California	Small boats	1983-88	Cascadia Res. Collective; Centre for Whale Research	27-28	190
Flukes	S.E. Alaska	Small boats	1979-88	Jan Straley		200-300
Flukes	N. Pacific	Small boats	1975-88	National Marine Mammal Laboratory	8,48,57-58, 67-68,77-78, 88-91	6000 ^c
<i>North Atlantic</i>						
Ventral flukes	North Atlantic	Small boats, whale watching vessels, etc.	1968-88	College of the Atlantic	1,2,4,6,30, 33,34,36, 71-76	3700
(comprised of	N.E. Atlantic	11				
	Iceland	20				
	Greenland	162				
	Newfoundland	1451				
	Gulf of Lawrence	123				
	Gulf of Maine	574				
	S.E. coast USA	3				
	Bermuda	114				
	Dominican Rep	1107				
	Puerto Rico	468				
	Virgin Bank	113)				
Flukes; dorsal fin size, shape, scarring, (body scars)	S. Gulf of Maine, W. Indies	Vessels	1978-88	Centre for Coastal Studies		550 ^d
<i>S. Hemisphere</i>						
Flukes (dorsal fin)	S. Africa	Ship	1985-88	P.B. Best		10
Flukes (dorsal fin, body pigment)	E. Australia	Boat	1984-88	G. Kaufman		400
Flukes	Palmer Peninsula, Antarctica	Research vessels inflatables	1986-87	College of Atlantic		30
Sperm whales						
<i>Indian Ocean</i>						
Fluke edges, dorsal fins	Sri Lanka	Small boats	1982-84	J. Gordon	10,22-23	50
<i>North Pacific</i>						
Fluke edges, dorsal fins	Galapagos Islands	Small boats	1985, 87	H. Whitehead	23	580
<i>North Atlantic</i>						
Fluke edges, dorsal fins	Azores	Small boats	1985-87	J. Gordon	22	50
Fluke edges, dorsal fins	W. Indies	Small boats	1982-86	T. Arnbohm	23,51,64	50
Fluke edges, dorsal fins	Nova Scotia	Small boats	1986	T. Arnbohm	23	2
Fluke edges, dorsal fins	N. Norway	Small boats	1987	T. Arnbohm	53	40

Cont.

Primary Character (Secondary)	Area	Platform	Years	Custodian	Contributors	Approx cat. size
Killer whales						
<i>S. Hemisphere</i>						
Dorsal fins, scars	Argentina	Shore	1986-88	J.C. Lopez	39,54	35
Dorsal fins	Marion Island	Shore	1985-87	Mammal Research Inst.	55	10
<i>N. Atlantic</i>						
Dorsal fin, saddle patch	Iceland	Small boats	1981-86	T. Lyrholm	53,58,73	140
<i>N. Pacific</i>						
Dorsal fin, saddle patch	S.E. Alaska	Small boats	1976-88	Centre for Whale Research	47,57,58	150
Dorsal fin, saddle patch	British Columbia Washington	Small boats	1973-87	M. Bigg	56-58	350
Dorsal fin, saddle patch	E. Gulf of Alaska	Small boats	1984-87	Hubbs Marine Res. Inst.	43,45,47 57, 58	300
Dorsal fin, saddle patch	Gulf of California	Small boats	1982-86	D. Breese, A. Acevedo	69-70,24	30
Bottlenose dolphins						
Dorsal fin, scars, freeze brands	Central west, Florida	Small boats	1970-88	R.S. Wells <i>et al.</i>	59	480
Dorsal fin, scars	S. California	Small boats	1981-83 1984-88	San Diego State Univ.	60,61	400
Hector's dolphins						
Dorsal fin, scars (pigmentation)	New Zealand	Small boat	1984-88	E. Slooten, S. Dawson		300
Risso's dolphins						
Dorsal fin, nicks, notches	Monterey Bay, California	Small boats, whale-watching vessels	1985-88	S. Kruse	62-64	250
Dorsal fin, nicks, notches	Azores	Small boats	1987	T. Arnbom	22	60
Spinner dolphins						
Dorsal fin, nicks, notches	Hawaii	Small boats	1979-81	K. Norris <i>et al.</i>	11,63,65	220
Short-finned pilot whales						
Saddle mark, dorsal fin	Northern coastal Pacific, off Japan	Vessel	1986-88	Far Seas Fisheries Research Lab., Tokyo	66	100
Dorsal fin (saddle mark)	California	Small boats	1983-88	S. Shane, D. McSweeney		
Dorsal fin (saddle mark)	Hawaii	Small boats	1985-88	S. Shane, D. McSweeney		
White-beaked dolphins						
Scars, unusual pigment	S. Gulf of Maine	Vessels	1981-88	Centre for Coastal Studies		10
Baiji						
Dorsal fin, face pigmentation	Changjiang River	Research vessel & small fishing boats	1986-87	Inst.of Hydrobiology P.R.China		^e
Dorsal fin, notches, scars, wounds	From Jinjiang to Heishazhou Changjiang River	Small boat	1988	Nanjing Normal University, P.R. China		^e

^a Range accounts for maximum if only one side of the whale was photographed, while minimum represents whales with both sides photographed.

^b + 500-600 fluke identifications not analysed

^c This total is (except where indicated) a catalogue of collections with multiple years of data and photos of individuals, and includes most of the data sets mentioned above.

^d 216 in publ catalogues; fluke photos included in North Atlantic catalogue, other body parts not.

^e Just starting project

Contributors

1. Univ. of Rhode Island, RI; 2. Center for Coastal Studies, Provincetown, MA; 3. Woods Hole Oceanographic Institute, MA; 4. College of the Atlantic; 5. Marineland of Florida; 6. Cetacean Research Unit of Gloucester; 7. University of Guelph; 8. Okeanos Ocean Research Foundation, NY; 9. About 5 whale-watching organisations and 30 individuals; 10. R. Payne; 11. B. Würsig; 12. C. Clark; 13. P. Thomas; 14. K. Payne; 15. G. Harris; 16. J.T. Palazo; 17. L.G.L. Ltd; 18. Cascadia Research Collective; 19. NOSC; 20. EnviroSphere; 21. A. Alling; 22. J. Gordon; 23. H. Whitehead; 24. Others; 25. Long Marine Laboratory; 26. Moss Landing Marine Laboratory; 27. Farallones Research Assoc.; 28. Hopkins Marine Station; 29. GREMM; 30. Atlantic Cetacean Research Center, Gloucester, MA; 31. Web of Life Study Center, Plymouth, MA; 32. Maine Whalewatch, Northeast Harbor, MA; 33. New England Aquarium, Boston, MA; 34. Whale Research Group, Memorial Univ., St Johns, Newfoundland; 35. Mystic Marineland Aquarium, Mystic, CT; 36. Mingan Island Cetacean Study, Sept Iles, Quebec; 37. E. Dorsey; 38. J. Stern; 39. R. Hoelzel; 40. Jeff Jacobsen; 41. B. Tershy; 42. D. Breese; 43. J. Hall; 44. J. Reinke; 45. C. Matkin; 46. O. von Zeigesen; 47. D. McSweeney; 48. J. Straley; 49. B. Dolphin; 50. G. Kaufman; 51. W. Watkins; 52. P. Tyack; 53. T. Lyrholm; 54. J.C. Lopez; 55. Mammal Research Institute, University of Pretoria; 56. M. Bigg; 57. K. Balcomb; 58. S. Leatherwood; 59. Dolphin Biology Research Associates Inc.; 60. L.J. Hansen; 61. R.H. DeFran; 62. S. Kruse; 63. R. Wells; 64. D. Goley; 65. M. Würsig; 66. T. Kasuya; 67. University of Mexico (UNAM); 68. University of Baja California (UABCS); 69. Instituto de Tecnología y Escuela Ciencias Marinas, Guaymas (ITESM); 70. Programa Nacional de Investigaciones y Conservación de Mamíferos Marinos (PNICMM); 71. Sea Mammal Research Unit, Cambridge, England; 72. Greenland Fisheries Environmental Research Institute; 73. Iceland Marine Research Institute; 74. Dalhousie University; 75. Brier Island Ocean Study; 76. Centre for Marine Biological Investigations, Autonomous University of Santo Domingo, Dominican Republic; 77. M. Ferrari; 78. D. Glockner-Ferrari; 79. M.W. Cawthorn; 80. Campbell Island Meteorological Station personnel; 81. C. Strong; 82. L. Findley; 83. O. Vidal; 84. S. Flores; 85. L. Fleischer; 86. G. Silber; 87. M. McKammy; 88. Kewalo Basin Marine Mammal Laboratory; 89. North Gulf Oceanic Society; 90. West Coast Whales Research Foundation; 91. Pacific Whale Foundation

Two workshop papers, SC/A88/P15 and P17, explored the use of acoustic techniques in conjunction with photo-identification studies. These were distributed but not discussed. These papers, and one other not available in manuscript form (SC/A88/P2) were presented as posters during the symposium.

7. DATA COLLECTION PROCEDURES

7.1. Sampling strategy

Information on research objectives, study area, research platform, sampling period and sampling strategy for nine species of mysticetes and four species of odontocetes is contained in Annex E.

Existing photo-identification studies have concentrated on species or local populations containing approximately several hundred to several thousand individuals (e.g. over 3,500 animals in the North Atlantic humpback whale catalogue).

Sampling protocols developed so far reflect a compromise between obtaining broad geographic sampling coverage, maximising the number of individuals sampled and dedicating adequate sampling time to each individual encountered. Ongoing studies involving photo-identification have a variety of objectives and some, such as behavioural investigations emphasising focal animals, require sampling strategies that are not ideal for providing data useful in estimating population size (e.g. SC/A88/ID44). On the other hand, broad-scale sampling programmes designed for estimating population size may not yield data adequate for estimating calving rate, mortality or other parameters. Some projects concentrate on only one segment of the population, such as right whale cows and calves (e.g. SC/A88/ID16). Such studies can provide information on population growth trends even if they cannot produce estimates of total population size.

Photographs for individual identification are often obtained opportunistically or incidentally to other dedicated projects. This may be unavoidable, owing to financial constraints or reliance on commercial whale watching vessels which have fixed schedules and must direct their efforts toward locations of known whale abundance or towards animals displaying particular behaviour.

None of the sampling protocols described in Annex E are random, and most emphasise areas of known or suspected cetacean abundance. Sampling of animals in narrow strip widths has occurred nearshore for right whales on their breeding grounds and for bowhead whales migrating in leads. Effort has been concentrated on productive feeding banks or near productivity-enhancing submarine topographic features for humpback, fin, minke and right whales. Sampling efficiency has also increased in photo-identification studies at locations where species such as gray, right or humpback whales aggregate for breeding.

When animals are located, efforts are made to obtain good photographs of identifying features. Up to an hour may be required in some cases if the animals dive for long periods of time or are uncooperative (SC/A88/ID34). Some species, such as humpback whales, may be reliably photo-identified from only one photograph, but photographs of additional body features, e.g. dorsal fin, may facilitate re-identification and may allow problems of 'tag loss' to be investigated if the primary mark changes or

is lost (e.g. see SC/A88/ID35). Other species, such as right, bowhead and fin whales, may require suites of photographs of numerous features on both sides of the body. Obtaining complete photographic coverage of such species can require substantial field time. Use of appropriate platforms can reduce this problem, for example the use of aircraft and helicopters to photograph right whales. In such cases a single photograph of the dorsal view of the head can replace photographs of the left and right sides of the head. Aircraft are expensive and are not feasible for daily offshore work on feeding ranges. Aircraft have been used in some locations to increase sampling efficiency by guiding boats to whales.

The usefulness of photo-identification studies will be maximised if careful records are kept for all data associated with each photograph and if investigators extend sampling strategies as broadly as possible within practical limits. It is important to design sampling programmes consistent with geographical or social boundaries of study populations if data are to be used in the estimation of population parameters. A useful technique may be to initiate a project and then modify the sampling programme in subsequent seasons guided by previous results. Sampling design is discussed in Section 10.1.3.

Photo-identification studies of several odontocetes have been facilitated by the restricted habitats of study populations. Long term investigations of pods of killer whales resident year round in Puget Sound and near Vancouver Island have been carried out for 20 years (SC/A88/ID3). Bottlenose dolphins have been studied close to shore along the Florida coast for 18 years (SC/A88/P22). Long-term stability of groups or association between individuals further facilitates sampling of killer whales, sperm whales and bottlenose dolphins. Photo-identification sampling of some odontocete species may be hindered by large population size or difficulty in photographing small, fast animals. Nevertheless, sufficiently clear photographs reveal natural markings useful for individual identification, and ongoing studies of local populations of pilot whales, Risso's dolphin, dusky dolphin, spinner dolphin, Dall's porpoise, white whale, Pacific white-sided dolphin, beiji and others show great promise (see summary in SC/A88/ID13).

7.2 Techniques for the collection and storage of biopsy samples

Only an outline of field techniques is provided here. More details are given in Annex F but the reader should consult the following papers for a full discussion: Lambertsen, Baker, Duffield and Chamberlin-Lea (1988); Hoelzel and Dover (1989); SC/A88/ID28 and 29.

Small biopsy darts can be used to collect samples of living tissue from free-ranging cetaceans and several designs have been described for darts used to collect samples from a variety of species (Winn, Bischoff and Tarushi, 1973; Aguilar and Nadal, 1984; Mathews, Keller and Weiner, 1988; Lambertsen, 1987; SC/A88/SD29). Maximum information can be obtained through the collection of all dermal layers and some blubber. The dermal tissues can be used for a variety of genetic and biochemical analyses, including karyotyping, protein electrophoresis and examination of variation in mitochondrial DNA and nuclear DNA. Blubber samples can be used for toxicology and fatty acid composition studies in naturally-marked populations.

Once the sample has been obtained, procedures for storage vary with the type of study it is to be used in. For DNA analysis the sample simply needs to be scored, immersed in saturated salt solution and frozen if possible. For subsequent cell culture a sterile environment is essential (SC/A88/ID28); methodology is described in Annex F.

7.3. Genomic catalogues

DNA fingerprints consist of a ladder of bands on autoradiography film. The molecular weight of a particular band can be determined as a function of the distance it migrated on the gel. The pattern can therefore be described and stored in computer memory as a series of molecular weights. There are two main problems with the interpretation of this information (for a more complete discussion see SC/A88/ID29).

The first problem is that bands vary in intensity and some are sufficiently faint that they may not be detected every time the same sample is run under standardised conditions. There are at least two possible solutions to this: one is to ignore bands below a certain intensity, the other is to run a standard of varying intensity bands on each gel.

The second problem is related to characteristics of the gel which determine the differential band migrations. Even when gels are carefully controlled there can be some variation in the migration pattern from one side of the gel to the other. This can be solved by rejecting imperfect gels, or by standardising each line with a separate marker.

7.4. Photographic techniques

Obtaining a good photograph for photo-identification studies depends on the following factors:

- (1) choice of equipment;
- (2) choice of film and developing procedures;
- (3) ability to approach an animal and behaviour of animal.

To some extent these will vary by species. However, for all species, the importance of taking or dictating good field notes cannot be overemphasised. Separating field events using marker photographs (e.g. blanks, the time on a watch, the horizon as a diagonal on a frame) is recommended. A summary of lenses and films currently used is given in Table 2.

Equipment

It is important to use high quality cameras and lenses. There was some discussion of the value of auto-focus lenses. It is unclear whether these lenses are fast enough for use on small cetaceans. However they have been shown to work well for killer and humpback whales. Automatic aperture or shuttering has advantages in rapid shooting across a changing field. However glare, ice, etc. might cause false metering such that the photographer might often need to use manual override. Auto-focus and auto-metering equipment are controlled electronically and may prove less than perfectly reliable under severe field conditions.

It is important to take several photographs of an individual to ensure that a suitable photograph or suite of photographs is obtained. A motor drive or power winder is recommended; the latter, although slower, is cheaper and usually sufficient.

The lens size chosen should be such that the diagnostic portion of the animal is as large as possible within the frame. Whatever lens is used, it is important always to use

the highest shutter speed and aperture setting possible to maximise the chance of obtaining a sharp image. Shutter speeds should always be 1/500th second or greater. If large lenses are used, some researchers strongly recommend use of a shoulder brace to keep the lens steady.

Table 2

Some lens and film types used in photo-identification studies. All are used from vessels apart from those marked with an asterisk which are used in aerial photography

Lens	Film Types
Humpback whales	
300mm	<i>Ilford</i> HP5 pushed to ASA 1600
Sperm whales	
300mm	<i>Ilford</i> HP5 pushed to ASA 1600
Fin whales	
300mm	<i>Ilford</i> HP5 pushed to ASA 1600
70-210mm (rose filter)	<i>Kodachrome</i> 64, <i>Ektachrome</i> 200+400 <i>Fujichrome</i> 100
Blue whales	
300mm	<i>Ilford</i> HP5 pushed to ASA 1600, <i>Kodachrome</i> 200
Minke whales	
300mm	<i>Ilford</i> HP5 pushed to ASA 1600
Bowhead whales*	
150-180mm	<i>Ektachrome</i> 200, <i>Fujichrome</i> 100
Large format	
Right whales	
300mm	<i>Ektachrome</i> 200 - Argentina*
Large format	<i>Ektachrome</i> 200 - South Africa*, Australia*
250mm	<i>Ektachrome</i> 200
Gray whales	
300mm	<i>Ilford</i> HP5/ <i>Kodak</i> TriX pushed to ASA 1600
Bryde's whales	
300mm	<i>Fujichrome</i> 100, <i>Ektachrome</i> 200, <i>Kodachrome</i> 64
Sei whales	
300-400mm	<i>Kodak</i> T-max at 400 ISO, <i>Kodak</i> TriX
Dall's porpoise	
300mm	<i>Kodak</i> TriX and T-max at 400 ASA
Baiji	
100-300mm	<i>Lucky</i> 400 and <i>Eastman</i> 200

Most workers use 35mm cameras. However, several aerial studies use medium-format cameras which cover a greater area of sea (e.g. SC/A88/ID15, 16 and 17). Experiments with a gyroscope to steady cameras used from an aircraft did not significantly increase the quality of photographs (SC/A88/ID1). As a back-up to keeping good notes, data-back cameras, which can include date and time on each frame, are recommended.

Incident light meters provide the best exposure readings for photographs taken from vessels whereas reflected light meters with narrowly focused fields are best for aerial photographs. Light meter readings should be taken frequently. At least two camera systems, one of which is operated manually, should be available in the field. It is important to practice handling and processing techniques before a field season.

Several workers have experimented with photogrammetric techniques, either using stereo photography or using accurate known-distance photographs. Examples include the work of Gordon (1990) on sperm whales, Jacobsen and Zimmerman (SC/A88/P10) on killer whales and various workers on bowhead whales (e.g. Cabbage and Calambokidis, 1987; Davis, Koski, Richardson, Evans and Alliston, 1982; Withrow and

Goebel-Diaz, 1989). The potential of auto-focus lenses to provide accurate distance measurements via a digital readout should be investigated.

Choice of film

For those species for which black and white photographs contain sufficient information (e.g. humpback, sperm, blue, killer and minke whales), the best film has been found to be *Ilford* HP5 push-processed to 1600 ASA. The processing procedure is described in Annex G.

A variety of colour slide and print film has been used. The most common are *Ektachrome* 200, *Kodachrome* 64 and *Fujichrome* 100. Although as yet not widely used, the new *Kodachrome* 200 was recommended by several workers.

If films are not being developed in-house, the importance of using a good professional laboratory cannot be overemphasised. If films are being developed in-house, the importance of keeping chemicals up-to-date similarly cannot be overemphasised.

Ability to approach animals/behaviour of animals

To obtain a good photograph, it is important to develop a method which permits a close enough approach at a suitable angle to the animal. For many species this involves the use of small boats with outboard motors. In such cases, rapid changes in engine speed and boat direction must be avoided. For aerial work, slow aircraft or helicopters are preferred to minimise the effect of movement relative to the animal. Typical altitudes for photography are 300–600ft, with the whale directly below the aircraft. For species where dorsal fin or flank photographs are required, an approach following the direction of travel of the whale but slowly getting closer to it has been successful.

7.5 Photographic catalogues and collections

7.5.1 Catalogues

It is important to distinguish between a catalogue, which contains the type specimen of each identified animal, and a complete photographic collection. However, in terms of creating a catalogue, i.e. choosing which animals (photographs) to include, the procedures are identical to the reidentification procedures discussed under Item 8.1, where photographs of sufficient quality (see below) which are not matched with those in the existing catalogue are added to it. In this regard it should be noted that 'poor' photographs of whales with identifying features that can still be discerned should be included in a catalogue.

Particular points to note about catalogues are that they should:

- (i) be periodically reassessed;
- (ii) be updated to include the best and most recent photographs of individuals (and should document any changes in patterns over time – see Item 8.2. below); and
- (iii) include, where possible, photographs of all identifying features and not just the primary feature used (e.g. with humpback whales, photographs of dorsal fins as well as flukes).

For certain species and/or platforms, suites of photographs may comprise the 'type photograph' (e.g. North Atlantic right whales, balaenopterid whales).

7.5.2 Photographic collections

There are two aspects that must be considered for each photograph. One is the quality of the photographic image, specifically as it relates to focus, glare, angle, distance or the amount of the identifying feature showing. The other is the distinctiveness of the identifying feature or markings of the animal. Some well marked animals are more easily reidentified than others, while some with less distinctive markings may be resighted but not recognised in subsequent sightings. It is recommended that *photographic quality* and *recognisability* be judged separately in categories excellent, good and poor (see Hammond, 1986; SC/A88/ID11).

The need to develop an objective method of evaluating photographic quality was noted in the context of deciding which resighting to use when estimating population abundance (see e.g. Arnbohm, 1987).

For estimating population size using mark-recapture methods, to ensure equal catchability, it is important to use only photographs whose quality is either excellent or good, no matter how 'distinctive' the animal's markings are. (See Item 10 below).

For other parameters such as calving intervals, poor photographs of distinctively marked individuals should be used to maximise the amount of available data (e.g. as described in SC/A88/ID30).

Archiving photographs

Given the long term benefits of photographs of identified whales, images should be carefully preserved. Many years, even decades, after photographs have been collected, they may still be important for studies of individual animals. Protection is needed against moisture, heat, dust, light, fire, theft, excess handling, mishandling and contamination. Contamination sources include glue in some boxes and plastics in non-archival quality storage sheets.

Photographs should be duplicated so that one collection is conveniently available and the other is well preserved. Using prints to search for matches while storing the transparencies is typical of many projects. Most researchers suffer budgetary restrictions that prevent full duplication of their collections; however where more than one photograph of an animal exists, the collection can be divided to some degree. Selected portions of a collection might be copied, in which case archival type film should be used.

Photographs should be stored vertically in metal file boxes, waxed paper boxes or plastic trays, in such a way that they are not in contact with each other. Although plastic sheets provide protection and convenient access to transparencies, they are not considered the best means for long term storage¹.

Long term storage should be in a low-access area that is fireproof (without sprinklers), cool, dry and secure from theft. Moisture is a greater concern than heat, in that a collection that cannot be stored in a watertight container should not be taken from cool storage to warm, moist areas, risking condensation. Fireproof boxes are rated for protection from burning stored materials, not for protection from melting. It is best to have duplicate collections at well separated locations.

¹ Kodak's book, *Conservation of Photographs* (F-40. Cat.#1935723, 156pp., \$33.30 US, via Eastman Kodak, Dept. 412L, 343 State St., Rochester, NY 14650) is recommended.

Storing images on video disc is recommended, since many images (54,000) can be contained in a small area with convenient access through a laser video disc player. Video discs can be copied and circulated among researchers. As data are not stored on the disc, the institution providing the photographs can retain control of the information. Video images are several generations away from the original, so video discs should not be considered the only means of archiving.

When a photographic collection is to be stored long-term, researchers should consider including well-documented data files with the photographs.

8. REIDENTIFYING INDIVIDUALS

8.1. Genomic data-bases

When individual identifications are stored in a computer-based catalogue, each can be listed as a series of molecular weights (SC/A88/ID29). A new individual can be compared with those already in the catalogue by comparison with each array of weights. Matches selected by the computer can be compared by eye from the original fingerprints. Any questionable matches can be re-run together on the same gel from the stored DNA. This requires storage of DNA from each individual as well as the series of molecular weights from the gel.

8.2. Methods for matching photographs

The aim of matching photographs is to determine whether or not an individual has been seen before. Methods of matching vary from catalogue to catalogue. Some workers examine negatives using a microscope (e.g., for killer whales – Bigg, humpback whale fluke patterns – Calambokidis), others examine contact prints and then make full-size prints of potentially 'new' animals (e.g. for humpback whales – Carlson), others examine colour slides (e.g. right whales – Bannister, fin whales – Agler); yet others examine full-size prints (e.g. minke whales – Dorsey). For animals easily identified in the field, detailed field notes can be valuable in matching.

To reduce the time needed to examine the catalogue for a match, many researchers pre-sort according to the category of the identifying features (see above) e.g. general colour pattern of a tail fluke. This is particularly important for large collections. Computer assistance in sorting is discussed below. However, any classification system is subject to errors and comparisons should not simply be made with the 'most likely' categories.

Whichever method is used, there are two major potential sources of error:

- (i) missing a match;
- (ii) falsely identifying a match.

To reduce the occurrence of such errors, the following protocols have proved successful:

- (i) matches or new whales should be confirmed by more than one, and preferably several, experienced workers;
- (ii) photographs should be viewed against catalogues several times;
- (iii) catalogues should be reviewed periodically for duplicates;
- (iv) long sessions of matching (>2–3hrs) should be avoided.

The value of using experienced workers is illustrated in SC/A88/ID35. Individuals become familiar with animals within their catalogues and with the most important identification features with experience. The possibility of using persons with above-average matching abilities, for example, those with eidetic memories, should be explored. The question of what to do with 'doubtful' matches was raised. This is particularly a problem with species which require 'suites' of photographs. It was agreed that 'doubtful' matches should be kept separately, and periodically examined against the catalogue. Keeping careful records of matches that are made after long periods of time will provide information on the extent of the problem of mis-matching.

In order to obtain better estimates of the probability of the two kinds of matching errors occurring, catalogue curators should, for each kind of error separately, record:

- (1) the date of the discovery of the error;
- (2) the date of entry of each photograph involved in the error into the catalogue; and, if possible
- (3) the number of photographs entered into the catalogue between the photographs involved in the error; and
- (4) the number of times the two photographs were compared before the error was discovered.

8.3 Computer assistance

Rowntree reported that her experience with right whales suggests that a catalogue of about 850 animals, for which a single matching attempt may take 3 hours, is about the maximum practical before computer assistance becomes desirable.

At present, two types of system are being developed. The first, exemplified in SC/A88/ID11 for humpback whales, scores coded descriptions of the identifying features and then ranks those already in the data base against the photograph to be matched. Images are then retrieved automatically from a video disc. This is a computerised version of the hand-sorting used for many catalogues, resulting in major time savings in both sorting and in retrieving images of likely matches. This system also allows for easy retrieval of images classified as described under Item 7.5.2.

The second type of system, exemplified in SC/A88/ID9 for seal pelage markings, uses a computerised 3-D model of the relevant part of the body of the animal. The photographic image is aligned with the model and digitised. This allows automatic matching of photographs taken at different angles. Although the seal catalogue is currently small, experimental testing has shown that about 2% of catalogue photos require comparison by eye with a given photograph. Such a system is particularly useful for patterns cannot easily be categorised and may be useful for species with complex flank patterns, such as the blue whale, or for species where the angle of the photograph can cause difficulties in matching, such as the right whale.

A system for sperm whales, using readily available software and hardware, is described in SC/A88/ID42.

9. SPATIAL AND TEMPORAL DISTRIBUTIONS

Studies of individually identified animals can be used to determine patterns of movement and patterns of association among individuals. Knowledge of such patterns can be used in designing studies for estimating population

parameters, in determining biases that might be expected in calculating parameters and, hopefully, in correcting such biases.

9.1 Population differentiation

For purposes of management, marine mammal populations are typically divided into management units, or stocks. If a genetic difference can be shown between such stocks, they may be referred to as genetic stocks. In general, genetic differences are not a necessary condition for defining management stocks but in most cases are a sufficient condition. Information from distinctively marked individuals or from DNA markers within individuals can be useful in defining stock structure.

The consistent return of individual humpback whales to the same feeding grounds has been used to define what have been called feeding sub-stocks in the North Atlantic (SC/A88/ID2). A similar pattern exists in the North Pacific (SC/A88/ID25).

Individual identification data have shown that North Atlantic humpback whales from many feeding grounds mix in the same breeding areas. The mixing may not be completely random in that individuals from one feeding area may more often frequent a particular breeding area. This heterogeneity may be further complicated by age and sex specific patterns of migration. Mixing on breeding grounds diminishes the chances of genetic isolation between putative feeding sub-stocks. The likelihood of genetic mixing is further supported by observations of seven courtship groups in the North Atlantic breeding grounds, which had recognisable individuals from different feeding areas within the same group (Mattila, Clapham, Katona and Stone, 1989).

Although there is reason to believe that feeding sub-stocks are not genetically isolated, it is possible that some genetic differences do exist. Molecular genetic tests for such differences are possible with biopsy samples from as few as 20 randomly selected individuals from each area. The likelihood that animals return initially to feeding areas with their mothers indicates that mitochondrial DNA (mt-DNA) techniques may prove useful, especially if used in conjunction with nuclear DNA methods such as DNA fingerprinting. Although mt-DNA was not successful in distinguishing morphologically-defined stocks of tropical dolphins (Dizon, 1987), the resolution power can be increased over that used in their study. Approaches to population discrimination using molecular markers are reviewed by Hoelzel and Dover (1989).

Hoelzel and Dover (1989) recommended that molecular genetic techniques be tried with humpback whales to examine questions of stock differentiation. Sufficient samples for a preliminary study might be obtained using biopsy samples from stranded whales from at least two feeding stocks in the North Atlantic. As in any genetic study, individual identification data from those whales would be valuable in interpreting results.

Preliminary results of comparisons between resident and transient killer whales in the northeastern Pacific indicate the presence of genetic differences. Hoelzel reported that additional tests using more powerful techniques are being applied in an attempt to confirm this. Behavioural and morphological differences have previously been noted between resident and transient groups (SC/A88/P17).

In addition to colour patterns, differences in the frequency of scars and marks such as killer whale tooth marks on flukes may be useful in defining stocks.

9.2 Relationships within populations

Persistent relationships between individuals have been found in many cetacean studies (e.g. see SC/A88/ID3). Such relationships are capable of biasing estimates of certain population parameters, such as those that assume random mixing of individuals. Whitehead (SC/A88/ID45-formerly SC/40/Sp3) has developed an index called the correlation of association to describe the patterns of recurring association between individuals. He also presents a test for determining whether a given group is closed, based on this correlation. This is discussed further under Item 10.

Site and temporal specificity

Based on resightings of distinctive individuals, some animals return consistently to a particular location. Some may also show considerable temporal specificity, such as returning to a certain location at the same time of the year. In a migrating species, this temporal specificity might be exemplified by an individual that passes a given point at approximately the same time each year. Such site and temporal specificity in movement patterns could potentially bias the estimation of population parameters.

Site and temporal specificity have both been demonstrated for humpback (e.g. SC/A88/ID2 and 25) and right (e.g. SC/A88/ID16 and 18) whales. Humpback whales show site specificity in their return to feeding areas. Temporal specificity is shown in the synchrony with which some humpbacks and right whales appear to return to the breeding areas in different years. However, individual humpback and right whales have been seen to make large changes in their movement patterns over short time periods.

Different sex and age classes often show differences in site specificity and can show differences in temporal patterns as well. For instance, female right whales with calves segregate from other animals near the coasts of South Africa, Argentina, and Australia. Adult bowhead whales appear to migrate later than younger age classes. Such differences may make it necessary to estimate population parameters separately for particular age and/or sex classes of a population (e.g. see SC/A88/ID16).

10. ESTIMATING POPULATION PARAMETERS

10.1 Population size

The use of existing capture-recapture models to estimate population size is appealing because they are well-known and have been well-studied. All the model assumptions have been stated, tests are available to investigate the violation of these assumptions and a considerable amount of work has been done on the effects of these violations on estimates of population size. However, because it is unlikely that an existing model will be exactly appropriate for any particular study, the development of new models (e.g. SC/A88/ID1) is essential to obtain the maximum from the biological information.

Capture-recapture techniques using photo-identification data provide estimates of absolute abundance but the most important consideration for populations recovering from severe depletion is the rate at which they are recovering. In these cases, estimates of relative abundance are equally

useful. Series of absolute estimates may give trends even if they are biased as long as the bias is consistent with time. However, in Jolly-Seber analyses of data where heterogeneity is present, bias is greater in estimates at the beginning and end of a series even if heterogeneity remains constant throughout the study period. A series of independent Petersen estimates would not have the same problem but, in general, care needs to be taken in the interpretation of series of estimates. A good example of this is the apparent increase in the number of humpbacks in the Gulf of Maine as discussed in SC/A88/ID4.

An alternative to using a series of population estimates to determine whether or not a population is increasing or decreasing is to obtain accurate and precise estimates of survival rate and reproductive parameters. SC/A88/ID5 and SC/A88/ID6 demonstrate that it is possible to estimate these parameters with a high degree of precision from photo-identification data if sample sizes are large enough to ensure high resighting probabilities. There is certainly merit in following both approaches; which is better will depend upon the circumstances of each study. It is worth noting that the poor definition of markings in very young animals of some species (e.g. humpback whales, SC/A88/ID35) may make the estimation of juvenile survival rates difficult.

10.1.1 Models and assumptions

The Workshop found it convenient to use Hammond (1986) as a basis for discussion of the estimation of population size from photo-identification data. This paper describes the basic models, their assumptions, some likely violations and their effects on population estimates.

The most important assumptions were identified as being geographical closure, demographic closure (for closed population models), permanence of markings and equal catchability.

(i) Geographical closure

In any capture-recapture study it is essential to define the population under investigation and thus the group of animals to which the population estimates refer. The Workshop recognised that animals do move in and out of study areas especially on feeding grounds where distribution will change in response to prey movements (e.g. see SC/A88/ID23). In addition, whales are known to segregate in breeding and feeding areas and on migration. There are two ideal cases for a study: (i) an area where the whole population is known to return on a regular basis is sampled; (ii) a subset of the population which is known to return regularly to the same area is sampled. An example of the former is the study of humpback whales in the North Atlantic where there is evidence that the entire population migrates to and mixes on the breeding grounds (SC/A88/ID2). An example of the latter is the study of right whale cows and calves off South Africa (SC/A88/ID16). If neither of these ideal situations exist, the study population will not be geographically closed (e.g., SC/A88/ID24, SC/A88/ID36). In these cases, additional data and/or the development of new models will be necessary to account for this. This is discussed further below under Item 10.1.3.

(ii) Demographic closure

Open population models, such as the Jolly-Seber model, allow for births (including permanent immigration) and deaths (including permanent emigration). Closed

population models assume no demographic change but this assumption can be relaxed for the two sample Petersen model. In particular, if there are no births, then the Petersen model can give a valid population estimate at the time of the first sample even if mortality is occurring. This is the basis for using the Petersen model to estimate North Atlantic humpback population size (SC/A88/ID2). For long series of data, the Jolly-Seber open population model is the obvious existing model to investigate but a series of independent Petersen estimates may be more appropriate under certain circumstances (see above and SC/A88/ID4).

(iii) Permanence of markings

If natural markings change with time this will have the same effect as tags being lost in conventional capture-recapture studies, i.e., population size will be overestimated. In general, for all species, researchers are confident that any changes which do occur in natural markings do not seriously affect their ability to reidentify whales. This is supported by evidence from 'doubly marked' (i.e. where in addition to the standard identification feature, such as the fluke shape and colour pattern, an additional feature, such as the shape and pigmentation of the dorsal fin, is available) animals in both right and humpback whales. For some species, changes are much more common in young animals; for example right whale calves cannot be identified in the first few months of life. SC/A88/ID35 addresses the problem of fluke markings changing with time in North Atlantic humpback whales. It concluded that changes in fluke patterns during the first two years of life can cause errors in identification and that general matching errors were approximately equally divided between making a false match and failing to make a match. These results suggest that humpbacks less than two years of age should not be included in the marked population for the purposes of estimating abundance.

10.1.2 Unequal capture probabilities

Most simple models for estimating population size from capture-recapture data assume that all animals are equally likely to be captured within a sampling occasion. This is unlikely to be true for a number of reasons. First, marking may affect catchability. This is likely to be less of a problem in photo-identification studies than in conventional capture-recapture studies. However, there are certain factors that could be relevant. One of these is the 'friendly whale' phenomenon where animals become habituated to boats (e.g. humpbacks in the Gulf of Maine). This may result in animals becoming more or less likely to be photographed. In studies where the photographs are taken from aircraft some animals may become habituated to the sound of the aircraft or may react adversely to it. In practice, any problem of this nature is likely to appear as heterogeneity of capture probabilities rather than as probability of capture changing after marking.

Heterogeneity of capture probabilities, where individual animals have inherently different likelihoods of being captured, will occur to some extent in most if not all photo-identification studies. The effect is to cause an underestimate in population size as discussed in SC/A88/ID4. Hammond (1986) divides the capture process in photo-identification studies into three phases: sighting the whale, photographing the whale and including the photograph in the sample; he discusses how each may

suffer from heterogeneity. Problems of heterogeneity in sighting whales are similar to those of geographic closure as discussed above (and see below under Item 10.1.3).

Problems of heterogeneity in photographing whales include researchers being able to recognise individuals in the field, differential reaction of whales to boats or aircraft, and differential behaviour of individuals. If inclusion of a photograph in a sample is based on identifiability rather than photographic quality, this will also introduce heterogeneity. Hammond (1986) and SC/A88/ID4 describe some ways to reduce the effects of this on estimates of population size.

10.1.3 Improvements to existing methods

It is important to stress that it is not possible to list a series of existing models for analysis from which can be chosen the 'best' model. This is because each biological situation is different and it is likely that none of the existing models is directly appropriate. What is needed is the development of a model for each particular species in a given area. The key factor here is the utilisation of biological information in addition to the capture-recapture data.

Analyses of data from very well studied populations, such as the resident killer whales of British Columbia and Washington, could be useful in determining how sensitive estimates of population parameters are to variability in sampling. Care should be taken, however, in drawing general conclusions from specific studies, precisely because each situation is different. In this respect, a well-designed simulation study could be more valuable. Subsets of data from existing data sets can be used to test assumptions or to investigate how well certain models perform.

There are certain problems with the estimation of population size using existing models which can be addressed by the development of new analytical techniques, by the collection of additional data or both. In particular, the important problem of all whales not being equally catchable in a given sample can be investigated and potentially accommodated in some cases. If a known group of animals, such as cows and calves, frequents an area regularly, then the model described in SC/A88/ID16 is an appropriate way to analyse the data. In this case, the additional biological information being used is the distribution of calving intervals. It may be possible using maximum likelihood methods or by extending the Bayesian methods used in SC/A88/ID16 to estimate the most likely combination of survival rate and rate of population change rather than having to provide an independent estimate of survival.

If it is suspected or apparent that a group of animals of unknown size and composition is unavailable or less available to be sampled in a given season, the problem is more difficult. However, additional data on the presence of animals outside the study area and the distribution of animals within the study area could be collected and used in models developed to utilise this extra information. In the first case, regular aerial surveys of the study area and the surrounding area would show how the relative proportions of animals inside and outside the study area change with time. Alternatively, by extending photo-identification effort outside the usual study area, the distribution of a sample of individual animals inside and outside the area could be obtained (e.g. SC/A88/ID24). This may also be achieved by telemetry. These data could be used to calculate rates of exchange between the study area and the surrounding area.

In the second case, the study area could be split up into sub-areas and the proportion of time that a sample of individuals spent in each sub-area used to investigate at what rate the population mixed within the study area. These problems are more apparent in some areas than others. Animals in feeding areas will tend to change distribution in response to their prey. In breeding areas this may be less likely; for example, the available evidence suggests that humpback whales move through their breeding areas in a steady parade.

Subsets of data consisting of animals known to be alive during a certain period can be used to test the assumption of equal probability of capture (Carothers, 1971; Seber, 1982, pp. 161–2, 226–8) although the power of the test is weak. Such data could also be used to construct models in which the probability of an animal being seen in any given year is a function of whether or not that animal was seen in the previous year or years. This is the kind of model described in SC/A88/ID7 for sperm whales which could be very useful in cases where the animals under study are known to be part of a larger population.

In cases where identification of animals requires a 'suite' of photographs (e.g. North Atlantic right whales, fin whales), heterogeneity of capture probabilities may be introduced if sufficient photographs cannot be taken of each animal in order for it to be identified. The solution to this problem is to ensure that enough time is spent with each animal to allow identification. If this cannot always be done, data on the number of encounters with whales where identification could not be achieved and data on times from first encounter to last photo-identification picture for all whales would allow the problem to be addressed. These considerations also apply to species where only one photograph may be needed to identify an animal, but the problem is likely to be more acute the more photographs are required.

As general guidelines to researchers concerned about the problem of some animals being less available than others, it may be useful to consider the following. Firstly, look for evidence that there is not homogeneous mixing within the study area. If this is apparent, as is likely in feeding areas, it may be necessary to adjust sampling strategy. For example, areas visited only when whales are not present in other areas may need to be sampled more regularly. Secondly, increase sampling to an area beyond the study area to investigate rates of movement in and out of the area. If there is significant movement, either sampling should be extended to a wider area if the aim is to cover the whole population, or models should be developed to take account of the problem if the aim is to study a particular area (e.g. as in SC/A88/ID24). Finally, it is important to include a statistician in the research team to advise on sampling strategy and develop models for analysis.

10.2.1 Survivorship

As with abundance estimation, the Workshop noted that the major difficulty in estimating survival rates from natural markings data is usually heterogeneity in the probabilities of identification. However, the problem may be investigated if cohorts of identified animals are defined, and survival rates estimated over time for each cohort. The cohort for a given year is defined to be all whales first identified in that year. Cohorts may be combined by date to assess which survival estimates show evidence of bias as a result of heterogeneity in probabilities of identification or

whether survival is variable over time. Alternatively, cohorts may be combined by 'age' (i.e. years from first identification) to assess whether survival is age-dependent. Further details are given in SC/A88/ID5. It was noted that the methods are unlikely to yield useful estimates of calf and juvenile survival rates. This is an omission that must be rectified if survival estimates are to be used in conjunction with reproductive rates to monitor population size. It was thought that North Pacific and North Atlantic humpback and Argentinean right whale data may allow estimation of juvenile survival rates at least over a six-month period, from identified cow-calf pairs (see Item 11).

If the open-population Jolly-Seber model is applied, and survival is thought to be variable over time, a simple arithmetic or geometric mean of the survival estimates will provide an approximately unbiased estimate of 'average' survival if probabilities of identification are homogeneous. However, in the presence of age-specific and/or time-specific rates, average survival is a crude concept that may not be well defined; further heterogeneity causes the estimate to be biased downwards. Average survival may be estimated under this approach by taking the arithmetic mean of the age-specific survival estimates, weighted by the estimated number of identified whales contributing to each survival estimate. It was noted that age-specific survival rates are generally poorly estimated for older animals, since few (if any) data are available for them, unless a study is continued for several decades. The method of analysing cohorts is valid for an increasing (or decreasing) population.

Mark-recapture models generally do not allow mortality to be distinguished from permanent emigration. Independent information is required; for example, if there are several study areas, movement between them may allow estimation of migration rates, although distinguishing between permanent and temporary emigration may be difficult.

Minimum survival rates, based on animals known to be alive, may sometimes prove useful, although bias can be particularly high towards the end of a sequence of data (which would appear as reduced survival at older ages) if, for example, any animal not seen for at least three years is assumed to have died. A long sequence of data will reduce this difficulty, but sampling should be relatively homogeneous over time.

10.2.2. Reproduction

10.2.2.1. Age at first reproduction

Long-term photo-identification studies can provide valuable information on age at first reproduction of females. However it is important when presenting results not simply to provide a mean age but also to include:

- (i) a histogram of the distribution of known ages at first reproduction
- (ii) information on estimated ages at first reproduction (e.g. SC/A88/ID31)
- (iii) information on whether females included under (i) and (ii) were seen without calves in each year prior to the year they were first seen with a calf or whether they were absent from the study area in any years.

It was noted that unless studies are carried out for long time periods, there will be a tendency for animals maturing early to be over-represented. If known age animals become

available, either via strandings or scientific whaling, it is important that earplugs be collected if at all possible (see Item 11) to verify and calibrate current aging techniques.

10.2.2.2 Calving interval

As in the case of age at first reproduction, it is important that as much data as possible on the reproductive history of known females be provided, rather than simply reporting a mean calving interval. Whether she was present with a calf, present with no calf, or not seen should be reported for each animal for each year (e.g. see SC/A88/ID31).

10.2.2.3 Reproductive rate

Barlow (SC/A88/ID6) has developed a model of population growth that incorporates the sort of birth interval information that is commonly collected in studies of identifiable individuals. The model involves calculation of two sets of probabilities. It first estimates the probability of giving birth at each interval after the prior birth. Information used to calculate these birth interval probabilities include the number of individuals (a) seen with a calf, (b) seen without a calf and (c) not seen, all observed at a series of times after each cow/calf pair is seen. The second set of probabilities, the first birth probabilities, represents the likelihood that a female will be seen with a calf at a given age if she has never had a previous calf. It is estimated from the number of females seen (a) with calves and (b) without calves at given ages. This method for estimating the model parameters assumes that mortality rates are the same for all adult females and that they are known. It also requires that the probability of being seen in a given season is the same for females with and without calves, and that this probability is either known or is estimated from the data. Modification of these methods may be possible to model actual populations for which data are already available. An alternative model which requires less information is discussed in SC/A88/ID1.

Given the two sets of probabilities (birth interval and first birth), the model in SC/A88/ID6 calculates age-specific birth rates as a Markov chain. By these methods, age-specific birth rates can be estimated for ages that are greater than the oldest known-aged individual.

The rather complicated estimation procedure for the birth interval model was deemed necessary due to biases in the more commonly used methods for estimating birth parameters. A simple calculation of mean birth interval is not sufficient to estimate mean reproductive rate because of the asymmetric contributions to population growth by individuals with less than average birth intervals relative to those with greater than average birth intervals. Estimation of birth intervals is further complicated by missed individuals. If missed individuals are not allowed in estimating birth intervals, the observed distribution will be skewed towards shorter birth intervals. If missed individuals are allowed and if some of those missed animals have a calf in the interim, the distribution will be skewed towards longer birth intervals.

Another common birth rate parameter that has been calculated from identifiable individuals is the ratio of births occurring in a given year to the number of individuals that are known to be mature. This parameter is typically biased because for the first year in which a female is known to be mature, she will always have a calf. This will overestimate the birth rate. If the first year is excluded and the average calving interval is greater than one year, birth rate will be underestimated. Because the degree of bias diminishes in a

predictable manner as the length of time that a female is observed increases, it may be possible to correct the bias in such an estimate of birth rate.

11. RECOMMENDATIONS FOR RESEARCH²

The Workshop draws attention to the fact that photo-identification studies are long-term and that their value is dependent on long-term funding.

The Workshop noted the serious analytical problems which can arise if photo-identification data are not obtained for one year of a long series. It therefore **strongly recommends** that the Scientific Committee assigns highest priority to funding requests in such circumstances. Should such requests be submitted they should be given higher priority than the recommendations in Table 3 below which require IWC funding.

Table 3

Proposals requiring funding* (list *not* in priority order).

Workshops	
Biopsy workshop	£15,000
Photogrammetry workshop	£20,000
Research proposals	
Further development of North Atlantic fin whale catalogue	£9,000
Video disc archive of photo collections or catalogues	£4,000
Further development of computer assisted matching	£5,000
Studies leading to estimates of calf mortality	£10,000

[*see Annex J for progress up to August 1990]

11.1 Catalogues and photographic collections

As discussed under Item 10, the value of using photo-identification data for estimating cetacean population parameters is considerably enhanced by having a single co-ordinating centre and catalogue for each species in each ocean area (e.g. North Atlantic and North Pacific humpback whales).

The workshop **recommends** that central catalogues be created for each species and ocean area e.g. blue whales in the North Atlantic. A specific proposal for a central catalogue for fin whales in the North Atlantic is given in Annex I1. The Workshop **recommends** this be funded. Where this is not practical, catalogues containing possible common individuals should be compared (e.g. comparison of photographs of humpbacks in the North Atlantic Humpback Fluke Catalogue with those of eastern Canadian animals curated by Mitchell).

The Workshop also **recommends** that funding should be continued for updating of existing catalogues.

When catalogues are being established it is important for co-ordinators to develop a list of associated data to accompany photographs and store them on a data base. These may include: date, time, location, photographer, roll of film, frame, identity of individual, behaviour including groupings. Precise requirements must be determined on a case by case basis.

As discussed under Item 7.5, it is important that photographic collections are protected from chance destruction or damage. The most practical and economic method appears to be storage on video disc. The workshop **recommends** that researchers arrange for their

photographic collections to be archived in this manner, either using the US National Marine Mammal Laboratory system or a similar local system. It was agreed that this should be co-ordinated by the NMML and that a copy of each disc should be stored by the Commission. These discs should be updated annually with the costs of mastering met by the Commission. Estimated costs for the coming year are £4,000.

It was noted that the disc stores only photographs. Associated data would be held by the supplying institution; use of the photographs thus remains under the control of supplying institution.

11.2 Analytical techniques

As discussed under Item 10, models for estimating cetacean population parameters need to be developed on a case-by-case basis. Similarly the value of field work and the ease of subsequent analysis are dependent on the sampling strategy chosen.

The Workshop **recommends** that research proposals using photo-identification techniques incorporate funding to employ a statistician to assist in experimental design and analysis of results.

It noted that the validity of current models and the effect of violations of assumptions can be tested by examining data from populations where most or all of the animals in a population are known.

11.3 Biopsy sampling

During discussion of several items the Workshop had noted the potential value of data which can be obtained from biopsy sampling. In addition to individual identification by DNA 'fingerprinting', biopsy samples provide the opportunity for other genetic and biochemical analyses of interest to the Commission.

The Workshop therefore **recommends** that the Commission sponsors a workshop on current studies, collection methodology and uses to which biopsy samples can be put, as outlined in Annex I2. Experts from both within and outside cetacean research should attend.

11.4 Collection of data from known-age animals

Collection of relevant material from previously identified animals, particularly earplugs from humpback whales of known age (see SC/A88/ID31), could help greatly in resolving current difficulties in determining rate of lamina deposition especially if the readers of previous earplug sets are available. This would permit conversion of existing data to absolute age, including those from earlier whaling operations for which earplug 'ages' already exist.

The Workshop **recommends**:

- (i) that every effort be made to obtain such material from animals taken in commercial, scientific or aboriginal whaling, and from stranded or entrapped animals. Whaling countries should ensure that animals taken from populations already subject to photo-identification studies are photographed as a routine.
- (ii) that further efforts be made to locate and/or examine earplug collections made by Chittleborough from Australian postwar humpback catches, and by Mitchell from eastern Canadian catches.

² Editor's note. This section contains all the Recommendations made at the May 1988 Workshop. I have summarised progress (up to July 1990) on those projects that required IWC financing in Annex J.

11.5 Effects of photo-identification and biopsy darts on study animals

Such effects can be broadly classified into two types, short-term (immediate reaction to the darting or approach of vessel for photography) and long-term (changes in distribution, survival or reproductive success caused by repeated attempts to biopsy or identify individuals). While short-term effects are more amenable to study, it is the long-term effects that are more significant for the health of the individual and population; these are by their nature very difficult to assess.

At this time the Workshop is unaware of any deleterious effects on the dynamics of whale populations caused by photo-identification studies, which in some cases have been in progress for up to 20 years. The effects of biopsy sampling, being a recent innovation, can not yet be evaluated in the same manner, but the Workshop felt that such activities are more likely to be short-term in nature and much more restricted in terms of the numbers of individual animals sampled.

The Workshop **recommends** that this topic be addressed by the Workshop proposed under Item 11.3.

11.6 Estimation of juvenile mortality

As discussed under Item 10.2.1, it may be possible to obtain an estimate of calf mortality from existing North Pacific humpback whale photographic data. However, much work is needed in correlating underwater and fluke photographs and in establishing collaboration between contributors with collections from the feeding and breeding grounds.

The Workshop **recommends** that the Commission provide partial support for the initial stages of the analysis and for the collections' integration into the NMML computer-based system, as described in Annex I3 .

11.7 Computer-assisted matching

The value of computer-assisted matching is discussed under Item 8.3. The Workshop **recommends** that this work be continued and that workers continue to exchange ideas and also to examine systems used for other non-cetacean species. The value of developing integrated systems was noted.

The Workshop **recommends** that the Commission provides funding for a study to evaluate the applicability of the digitising technique of SC/A88/ID9 to whale species as described in Annex I4 .

11.8 Workshop on photogrammetry

The Workshop recognised the value of studies combining photo-identification and photogrammetry, for example in establishing individual growth rates. It **recommends** that the workshop described in Annex I5 be funded by the Commission.

11.9 Extension of field studies

The Workshop noted that photo-identification of individuals is possible for all cetacean species studied so far, although not with equal facility for each. Estimates of population size have been calculated for several previously unassessed stocks. Measurements of calving intervals, ages at first parturition and adult survival rates have been obtained in some stocks, and are potentially obtainable in others, provided that the data series are continued uninterrupted.

The Workshop therefore **recommends** the continued funding of existing studies.

In addition, photo-identification studies and biopsy sampling have the potential of answering several wider questions relevant to cetacean biology.

The Workshop therefore also **recommends**:

- (i) the extension of existing studies to cover all areas of a population's range (e.g. humpback whales in the Bonin Is., off British Columbia, the Cape Verde Islands, Isla Gorgona (Colombia)).
- (ii) the initiation of photo-identification studies as part of other research programmes, including (a) in areas where scientific whaling occurs and (b) in the ongoing assessment of Antarctic marine ecosystems by CCAMLR members, using, for example, photo-identification of humpback, blue and southern right whale populations to delineate stocks and identify movements;
- (iii) studies on the efficiency of individual identification for species where it has not been extensively used;
- (iv) the comparison of breeding and feeding areas to permit possible capture-recapture population estimates of specific stocks;
- (v) incorporation in existing photo-identification studies of at least the opportunistic collection of tissue samples (e.g. from stranded or entrapped whales and from sloughed skin), to assess population genetic structure and assist in stock definition.

With respect to item (ii), the Workshop **recommends** that in the event of a further IWC/IDCR minke whale assessment cruise, the equivalent of 1–2 days work under good conditions be allocated to photo-identification of minke whales, as a feasibility study for a more dedicated study. It is important that an experienced and qualified person carry out this work. Similarly it **recommends** that such studies are undertaken for fin and minke whales in the North Atlantic.

11.10 Assistance to Third World Countries

Given the demonstrated value of techniques for the identification of individuals, and the initiation of studies of this nature by institutions in developing countries, the Workshop **recommends** that organisations with considerable experience in this field offer assistance to these institutions, collaborate more closely with them, and, where possible, accept visiting scientists under a programme of training in relevant techniques.

11.11 Development of 'Studbooks'

The Workshop particularly emphasises the value of photo-identification techniques in the assessment, monitoring and management of severely endangered cetaceans and **recommends** that such studies continue and be expanded for species such as *Eubalaena glacialis* (remaining population of perhaps 300) and *Lipotes vexillifex* (300–400 remaining), with the goals of identifying and monitoring the birth, reproduction, movements and deaths of all individuals in the populations. The potential exists of using biopsy techniques in tandem with photo-identification to determine sex and to establish genealogies comparable to the extremely valuable international species 'studbooks' that have been developed for many critically endangered terrestrial large mammals (see Ralls and Ballou, 1986).

11.12 Summary of recommendations seeking IWC funding
These are listed by heading in Table 3. The Workshop did not assign priorities but agreed that if insufficient funds are available partial funding for any or all could be considered.

ACKNOWLEDGEMENTS

The Workshop would like to thank the Southwest Fisheries Center for its hospitality and efficiency in hosting the meeting. The Rapporteur would like to thank Mike Bigg for useful comments on the draft manuscript.

REFERENCES

- Aguilar, A. and Nadal, J. 1984. Obtención de biopsias hipodérmicas de cetáceos en libertad. *Invest. Pesq.* 48:23-9. [In Spanish].
- Arnbom, T. 1987. Individual identification of sperm whales. *Rep. int. Whal. Commn* 37:201-4.
- Carothers, A.D. 1971. An examination and test of Leslie's test of equal catchability. *Biometrics* 27:615-30.
- Clark, C.W. 1989. The use of bowhead call tracks based on call characteristics as an independent means of determining tracking parameters. Appendix 2 of Annex G of the IWC Scientific Committee Report. *Rep. int. Whal. Commn* 39:111-3.
- Cubbage, J.C. and Calambokidis, J. 1987. Size-class segregation of bowhead whales discerned through aerial stereophotogrammetry. *Mar. Mammal Sci.* 3:179-85.
- Davis, R.A., Koski, W.R., Richardson, W.J., Evans, C.R. and Alliston, W.G. 1982. Distribution, numbers and productivity of the western Arctic stock of bowhead whales (*Balaena mysticetus*) in the Eastern Beaufort Sea and Amundsen Gulf, summer 1981. Paper SC/34/PS20 presented to the IWC Scientific Committee, June 1982 (unpublished).
- Dizon, A.E. 1987. Mitochondrial DNA and the genetic structure of spinner dolphin stocks and schools. US Department of Commerce, NOAA, NMFS, Southwest Fisheries Center, Report of Activities, May-June.
- Gordon, J.C.D. 1990. A simple photographic technique for measuring the length of whales from boats at sea. *Rep. int. Whal. Commn* 40:581-8.
- Hammond, P.S. 1986. Estimating the size of naturally marked whale populations using capture-recapture techniques. *Rep. int. Whal. Commn* (special issue 8):253-82.
- Hoelzel, A.R. and Dover, G.A. 1989. Molecular techniques for examining genetic variation and stock identity in cetacean species. *Rep. int. Whal. Commn* (special issue 11):81-120.
- International Whaling Commission. 1988. Report of the Scientific Committee. *Rep. int. Whal. Commn* 38:32-155.
- Jeffreys, A.J., Wilson, V. and Thein, S.L. 1985. Hypervariable 'minisatellite' regions in human DNA. *Nature, Lond.* 314:67-73.
- Lambertsen, R., Baker, S., Duffield, D. and Chamberlin-Lea, J. 1988. Cytogenetic determination of sex among individual identified humpback whales. *Can. J. Zool.* 66:1243-8.
- Lambertsen, R.H. 1987. Biopsy system for large whales and its use for cytogenetics. *J. Mammal.* 68:443-5.
- Mathews, E., Keller, S. and Weiner, D.B. 1988. A method to collect and process skin biopsies for cell culture from free-ranging gray whales (*Eschrichtius robustus*). *Mar. Mammal Sci.* 4:1-12.
- Mattila, D.K., Clapham, P.J., Katona, S.K. and Stone, G.S. 1989. Population composition of humpback whales, *Megaptera novaeangliae*, on Silver Bank, 1984. *Can. J. Zool.* 67:281-5.
- Ralls, K. and Ballou, J. (eds.). 1986. Proceedings of the Workshop on the Genetic Management of Captive Populations. *Zoo Biol.* 5:81-238.
- Seber, G.A.F. 1982. *The Estimation of Animal Abundance and Related Parameters*. 2nd Edn. Griffin Press, London. 654pp.
- Winn, H.E., Bischoff, W.L. and Taruska, A.G. 1973. Cytological sexing of Cetacea. *Mar. Biol.* 23:343-6.
- Withrow, D. and Goebel-Diaz, C. 1989. Distribution of bowhead whales near Point Barrow, Alaska, 1984-1986. *Rep. int. Whal. Commn* 39:305-8.

Annex A

List of Participants

Beverly Agler
North Atlantic Finback Whale Catalogue
Allied Whale
College of the Atlantic
Bar Harbor, ME 04609
USA

Carlos M. Alvarez Flores
Universidad Nacional Autonoma de Mexico
Laboratorio de Vertebrados
Facultad de Ciencias
Apartado Postal 70-400
C.P. 04510, Mexico, D.F.
MEXICO

Gao Anli
Nanjing Normal University
Department of Biology
Nanjing
CHINA

David Bain
Long Marine Lab
University of California
100 Shaffer Road
Santa Cruz, CA 95060
USA

Scott Baker
National Cancer Institute
Building 560, Room 21-105
Frederick, MD 21701-1013
USA

Ken Balcomb
Center for Whale Research
1359 Smuggler's Cove
Friday Harbor, WA 98250
USA

John Bannister
Director, Western Australian Museum
Francis Street
Perth
Western Australia 6000
AUSTRALIA

Jay Barlow
Southwest Fisheries Center
P.O. Box 271
La Jolla, CA 92038
USA

Judith Beard
College of the Atlantic
Bar Harbor, Maine 04609
USA

Peter B. Best
Mammal Research Inst., University of Pretoria
Whale Unit
c/o South African Museum
P.O. Box 61, Cape Town
8000 SOUTH AFRICA

Michael Bigg
Department of Fisheries and Oceans
Pacific Biological Station
Nanaimo, B.C. V9R 5K6
CANADA

Stephen T. Buckland
SASS, Aberdeen Unit
Macauley Land Use Research Institute
Craigiebuckler
Aberdeen AB9 2QJ
SCOTLAND

John Calambokidis
Cascadia Research Collective
Waterstreet Bldg, Suite 201
218 1/2 W. 4th Avenue
Olympia, WA 98501
USA

Carole A. Carlson
International Wildlife Coalition
634 North Falmouth Highway
PO Box 388
North Falmouth, MA 02556-0388
USA

Phillip J. Clapham
Center for Coastal Studies
Box 1036
Provincetown, MA 02657
USA

Doug DeMaster
Southwest Fisheries Center
P.O. Box 271
La Jolla, CA 92038
USA

Greg Donovan
International Whaling Commission
The Red House
Station Road, Histon
Cambridge CB4 4NP
ENGLAND

Eleanor M. Dorsey
Long Term Research Institute
191 Weston Road
Lincoln, MA 01773
USA

Debbie Glockner-Ferrari
Center for Whale Studies
39 Woodvine Court
Covington, LA 70433-4724
USA

Phil Hammond
Sea Mammal Research Unit
c/o B.A.S.
Madingley Road
Cambridge CB3 0ET
ENGLAND

Larry Hansen
Southeast Fisheries Center
Miami Laboratory
75 Virginia Beach Drive
Miami, FL 33149-1099
USA

A. Rus Hoelzel
University of Cambridge
Department of Genetics
Downing Street
Cambridge CB2 2EH
ENGLAND

Steven Katona
College of the Atlantic
Bar Harbor, Maine 04609
USA

Scott Kraus
New England Aquarium
Central Wharf
Boston, MA 02110-3309
USA

Tomio Miyashita
Nat. Res. Inst. of Far Seas Fisheries
5-7-1 Orido,
Shimizu, 424
JAPAN

Sally Mizroch
National Marine Mammal Laboratory
7600 Sand Point Way NE, BIN C15700
Seattle, WA 98115
USA

Roger Payne
Long Term Research Institute
191 Weston Road
Lincoln, MA 01773
USA

Bill Perrin
Southwest Fisheries Center
P.O. Box 271
La Jolla, CA 92038
USA

Vicky Rowntree
Long Term Research Institute
191 Weston Road
Lincoln, MA 01773
USA

Dave Rugh
National Marine Mammal Laboratory
7600 Sand Point Way NE, BIN C15700
Seattle, WA 98115
USA

Richard Sears
Mingan Island Cetacean Study
285 Green Street
St. Lambert
Quebec J4P 1T3
CANADA

Bernie Tershy
Moss Landing Marine Labs
P.O. Box 450
Moss Landing, CA 95039-0450
USA

Jorge Urbán
Universidad Autonoma de Baja California
Ap. Post. 219-B
Biología Marina (Ciencias marinas)
C.P. 23000
La Paz, B.C.S.
MEXICO

Randall S. Wells
Long Marine Laboratory
University of California
100 Shaffer Road
Santa Cruz, CA 95060
USA

Hal Whitehead
Dalhousie University
Biology Department
Halifax
Nova Scotia B3H 4J1
CANADA

Zhang Xianfeng
Academia Sinica
Institute of Hydrobiology
Wuhan Hubei
CHINA

Judith E. Zeh
University of Washington
Department of Statistics GN-22
B313 Padelford Hall
Seattle, WA 98195
USA

Annex B

Agenda

1. Chairman's welcome and opening remarks.
2. Arrangements for meeting.
3. Appointment of rapporteurs.
4. Adoption of agenda.
5. Review of available documents and reports.
6. Individual recognition.
 - 6.1 DNA fingerprinting
 - 6.2 Photographs of natural markings by species
 - humpback, right, killer
 - blue, fin, Bryde's, minke
 - gray, sperm, others
 - 6.3 Acoustic 'fingerprinting'
7. Data collection procedures
 - 7.1 Sampling strategy
 - 7.2 Biopsy darting and DNA fingerprinting
 - 7.3 Genomic catalogues
 - 7.4 Photographic techniques
 - 7.5 Photographic catalogues
8. Reidentifying individuals
 - 8.1 Genomic data bases
 - 8.2 Methods for matching photographs
 - 8.3 Computer assistance
9. Spatial and temporal distribution
 - 9.1 Population differentiation
 - 9.2 Relationships within populations
 - 9.3 Site specificity
10. Estimating population parameters
 - 10.1 Population size
 - 10.1.1 Models and assumptions
 - 10.1.2 Unequal capture probabilities
 - 10.2 Population rate of change
 - 10.2.1 Survivorship
 - 10.2.2 Reproduction
 - 10.2.2.1 Age at first reproduction
 - 10.2.2.2 Calving interval
 - 10.2.2.3 Reproductive rate
 - 10.3 Availability of computer programs for analysis.
11. Recommendations for future research
12. Any other business
13. Adoption of report

Annex C

List of Documents

Documents marked with * are published in this volume. For these papers, the authorship and title of the *published* version is given, not the authorship and title as presented at the meeting, if they differed.

SC/A88/ID

- 1* PAYNE, R., ROWNTREE, V., PERKINS, J.S., COOKE, J.G. and LANKESTER, K. Population size, trends and reproductive parameters of right whales (*Eubalaena australis*) off Peninsula Valdes, Argentina.
- 2* KATONA, S.K. and BEARD, J.A. Population size, migrations and feeding aggregations of the humpback whale (*Megaptera novaeangliae*) in the western North Atlantic Ocean.
- 3* OLESIUK, P., BIGG, M.A. and ELLIS, G.M. Life history and population dynamics of resident killer whales (*Orcinus orca*) in the coastal waters of British Columbia and Washington State.
- 4* HAMMOND, P.S. Heterogeneity in the Gulf of Maine? Estimating population size from individual recognition data when capture probabilities are not equal.
- 5* BUCKLAND, S.T. Estimation of survival rates from sightings of individually identifiable whales.
- 6* BARLOW, J. A birth-interval model for estimating cetacean reproductive rates from resighting data.
- 7* WHITEHEAD, H. Assessing sperm whale populations using natural markings: recent progress.
- 8 MCGOWAN, M.F. Whale image processing for data archival and individual identification.
- 9* HIBY, L. and LOVELL, P. Computer aided matching of natural markings: a prototype system for grey seals.
- 10 PALERMO, M.T. The Automated [Human] Fingerprint Identification System (AFIS)
- 11* MIZROCH, S.A., BEARD, J. and LYNDE, M. Computer assisted photo-identification of humpback whales.
- 12 BALCOMB III, K.C. Equipment and procedures for photo-identification studies of large whales.
- 13* WÜRSIG, B., and JEFFERSON, T.A. Methods of photo-identification for small cetaceans.
- 14 JOYCE, G.G. Opportunistic photo-identification studies: Time costs and results in the IWC/IDCR Southern Hemisphere minke whale assessment cruises.
- 15* RUGH, D.J. Bowhead whales reidentified through aerial photography near Point Barrow, Alaska.
- 16* BEST, P.B., and UNDERHILL, L.G. Estimating population size in southern right whales (*Eubalaena australis*) using naturally marked animals.
- 17* BANNISTER, J. Southern right whales off western Australia.
- 18* HAMILTON, P. and MAYO, C. Population characteristics of right whales (*Eubalaena glacialis*) observed in Cape Cod and Massachusetts Bays, 1978–1986.
- 19 ARNBOM, T., GORDON, J. and WATERS, S. Occurrence of natural marks on sperm whales, *Physeter macrocephalus*, from the Indian, North Atlantic and Pacific Oceans.
- 20* AGLER, B.A., BEARD, J.A., BOWMAN, R.S., CORBETT, H.D., FROHOCK, S.E., HAWVERMALE, M.P., KATONA, S.K., SADOVE, S.S., and SEIPT, I.E. Fin whale, (*Balaenoptera physalus*) photographic identification: methodology and preliminary results from the western North Atlantic.
- 21* DORSEY, E.M., STERN, S.J., and HOELZEL, A.R. and JACOBSEN, J. Minke whales, *Balaenoptera acutorostrata*, from the west coast of North America: individual recognition and small-scale site fidelity.
- 22* TERSHY, B., BREESE, D. and STRONG, C. Abundance, seasonal distribution and population composition of Balaenopterid whales in the Canal de Ballenas, Gulf of California, Mexico.
- 23* SEARS, R., WILLIAMSON, J.M., WENZEL, F.W., BÉRUBÉ, M., GENDRON, D. and JONES, P. Photographic identification of the blue whale (*Balaenoptera musculus*) in the Gulf of St. Lawrence, Canada.
- 24* CALAMBOKIDIS, J., STEIGER, G.H., CUBBAGE, J.C., BALCOMB, K.C., EWALD, C., KRUSE, S., WELLS, R. and SEARS, R. Sightings and movements of blue whales off central California 1986–88 from photo-identification of individuals.
- 25* PERRY, A., BAKER, C.S. and HERMAN, L.M. Population characteristics of individually identified humpback whales in the central and eastern North Pacific: a summary and critique.
- 26* STRALEY, J.M. Fall and winter occurrence of humpback whales (*Megaptera novaeangliae*) in southeastern Alaska.
- 27* ALVAREZ, C.F., AGUAYO, A.L., RUEDA, R.R., and URBÁN, J.R. A note on the stock size of humpback whales along the Pacific coast of the Mexico.
- 28 LAMBERTSEN, R.H. and DUFFIELD, D.A. Biopsy studies of the humpback whale (*Megaptera novaeangliae*). [To be published in special issue 13]
- 29* AMOS, W., and HOELZEL, A.R. DNA fingerprinting cetacean biopsy samples for individual identification.

- 30* GLOCKNER-FERRARI, D.A. and FERRARI, M. Reproduction in the humpback whale (*Megaptera novaeangliae*) in Hawaiian waters, 1975–1988: the life history, reproductive rates, and behaviour of known individuals identified through surface and underwater photography.
- 31* CLAPHAM, P.J. and MAYO, C.A. Reproduction of humpback whales (*Megaptera novaeangliae*) observed in the Gulf of Maine.
- 32 KRAUS, S.D. Rates and potential causes of mortality in North Atlantic right whales.
- 33* BAIN, D.E. Examining the validity of inferences drawn from photo-identification data, with special reference to studies of the killer whale (*Orcinus orca*) in British Columbia.
- 34* STERN, J.S., DORSEY, E.M., and CASE, V.L. Photographic catchability of individually identified minke whales (*Balaenoptera acutorostrata*) of the San Juan Islands, Washington and the Monterey Bay Area, California.
- 35* CARLSON, C.A., MAYO, C.A., and WHITEHEAD, H. Changes in the ventral fluke pattern of the humpback whale (*Megaptera novaeangliae*) and its effect on matching; evaluation of its significance to photo-identification research.
- 36* CALAMBOKIDIS, J., CUBBAGE, J.C., STEIGER, G.H., BALCOMB, K.C., and BLOEDEL, P. Population estimates of humpback whales in the Gulf of the Farallones, California.
- 37* FAIRFIELD, C.P. Comparison of abundance estimation techniques for the western North Atlantic right whale.
- 38* JONES, M-L. The reproductive cycle in gray whales based on photographic resightings of females on the breeding grounds from 1977–82.
- 39* BIGG, M.A., OLESIUK, P.F., ELLIS, G.M., FORD, J.K.B. and BALCOMB, K.C. Social organization and genealogy of resident killer whales (*Orcinus orca*) in coastal waters of British Columbia and Washington State.
- 40 RISK, L. The photo-identification and social organisation of Atlantic bottlenose dolphins, *Tursiops truncatus*, off Wassaw Sound, Georgia, USA. March-September 1987. With comparison to identified individuals from Beaufort North Carolina.
- 41* KAUFMAN, G.D., OSMOND, M.G., WARD, A. and FORESTELL, P.H. Photographic documentation of the migratory movement of a humpback whale (*Megaptera novaeangliae*) between East Australia and Antarctic area V.
- 42* WHITEHEAD, H. Computer assisted individual identification of sperm whale flukes.
- 43* JOYCE, G.G. and DORSEY, E.M. A feasibility study on the use of photo-identification techniques for Southern Hemisphere minke whale stock assessment. [Originally paper SC/41/SHMi11].
- 44* HAMMOND, P., SEARS, R. and BÉRUBÉ, M. A note on problems in estimating the number of blue whales in the Gulf of St. Lawrence from photo-identification data.
- 45* WHITEHEAD, H. and WATERS, S. Social organisation and population structure of sperm whales off the Galápagos Islands, Ecuador (1985 and 1987). [Originally paper SC/40/SP3].
- 46* GUNNLAUGSSON, Th. and SIGURJONSSON, J. A note on the problem of false positives in the use of natural marking data for abundance estimation.

SC/A88/P

- 1 ARNBOM, T., GORDON, J., MARTINS, H., SANTOS, R., and WALSH, V. Individual photo-identification of Risso's dolphin near the Azorean Islands.
- 2 BOWLES, A.E., FRANCINE, J.K., AWBREY, F.T., HALL, J.D. and LEATHERWOOD, J.S. Bioacoustic techniques can be used to track the distribution and movements of pods of killer whales (*Orcinus orca*).
- 3 CHU, K., and NIEUKIRK, S. Dorsal fin scarring in humpback whales (*Megaptera novaeangliae*) as indicators of age and sex-problems and potential
- 4* DEFRAN, R.H., SCHULTZ G.M. and WELLER, D.W. A technique for the photographic identification and cataloging of dorsal fins of the bottlenose dolphin (*Tursiops truncatus*).
- 5 GALLO-REYNOSO, J.P. The use of acrylic modeled dorsal fins in place of photography for the identification of small cetaceans.
- 6 GAO, A., SUN, J., and ZHOU, K. The possibility of using photographic technique to identify individual baiji (*Lipotes vexillifer*).
- 7 HALL, J.D. Analysis of proposed killer whale (*Orcinus orca*) ecotypes from Alaska using photo-identified individuals and discriminant function techniques.
- 8* HANSEN, L.J., and DEFRAN, R.H., A comparison of photo-identification studies of California coastal bottlenose dolphins.
- 9 HAYCOCK, C.R., BARNES, L., and GRAHAM, H. Investigation and monitoring of a localized humpback whale (*Megaptera novaeangliae*) population near Brier Island, Nova Scotia, Canada.
- 10 JACOBSEN, J., and ZIMMERMAN, J. Phototrix-2: A new photogrammetric technique and its application on wild Orcas (*Orcinus orca*).
- 11 KAUFMAN, G.D., OSMOND, M., and CHALOUPKA, M. Use of lateral body and fluke pigmentation patterns in population estimates of east Australian (Area V) humpback whales, (*Megaptera novaeangliae*).
- 12 KRUSE, S. A photo-identification study of Risso's dolphins in Monterey Bay, California – preliminary report.
- 13* MILLER, E. Photo-identification techniques applied to Dall's porpoise (*Phocoenoides dalli*) in Puget Sound, Washington.
- 14* MIYASHITA, T., KASUYA, T. and MORI, K. An examination of the feasibility of using photo-identification techniques for a short-finned pilot whale stock off Japan.
- 15 MOORE, S.E., Potential use of bioacoustics in conjunction with photographic and DNA identification to examine cetacean stocks.
- 16* LOCKYER, C. and MORRIS, R.J. Some observations on wound healing and persistence of scars in *Tursiops truncatus*.
- 17* MORTON, A.B., A quantitative comparison of the behaviour of resident and transient forms of the killer whale off the central British Columbia coast.

- 18 ODELL, D.K., ASPER, E.D., BURN, D.M., and DUFFIELD, D., Non-lethal studies of the population biology of the bottlenose dolphin (*Tursiops truncatus*) in the Indian River lagoon system, Florida, USA.
- 19 RUMAGE, Wm.T., The use of ultraviolet and infrared photography in determining pigment patterns and physiography in cetaceans.
- 20* SHANE, S.H., and MCSWEENEY, D., Using photo-identification to study pilot whale social organization.
- 21 THOMAS, P., Habitat use by southern right whale (*Balaena glacialis*) mothers and calves in Argentina.
- 22* WEIGLE, B., Abundance, distribution and movements of bottlenose dolphins (*Tursiops truncatus*) in Lower Tampa Bay, Florida.
- 23* WELLS, R.S., and SCOTT, M.D., Estimating bottlenose dolphin population parameters from individual identification and capture-release techniques.
- 24* YOICHEM, P., STEWART, B., MINA, M., ZORIN, A., SADOVOV, V. and YABLOKOV, A. Non-metrical analyses of pelage patterns in demographic studies of harbor seals.
- 25* YUANYU, H., XIANFENG, Z., ZHUO, W., and XIAOGIANG, W. A note on the feasibility of using photo-identification techniques to study the baiji (*Lipotes vexillifer*).
- 26 BAIRD, R.W., and STACEY, P.J., Variation in saddle patch pigmentation in populations of killer whales, *Orcinus orca*, from British Columbia, Alaska and Washington State.

Annex D

Report on an Exercise to Estimate Approximate Sample Sizes Necessary to Obtain Capture-Recapture Estimates of Fin and Minke Whale Populations of Different Sizes

To estimate approximate sample sizes that would be necessary to obtain capture-recapture population estimates of a given precision for fin and minke whales, a simple exercise was undertaken. This was limited to using the Petersen estimator and assuming that all model assumptions were satisfied. Population sizes were chosen for each species as follows: fin 10,000; minke 50,000, 100,000, 500,000. Coefficients of variation of 0.5 and 0.1 were chosen corresponding to approximate 95% confidence limits of $\pm 100\%$ of the estimate and $\pm 20\%$ of the estimate, respectively. It was felt important to calculate not only the number of animals which would need to be photo-identified, but also the number which would need to be encountered. To do this, estimates were made of the percentage of animals encountered which could be photographed (75% for fin and minke) and the percentage of those photographed which could be identified (100% for fin and 50% for minke). These estimates were based on the opinions of field workers who had extensive experience of photo-identifying fin and minke whales. Table 1 gives sample size estimates for these combinations of parameters. A more thorough review of this question for minke whales, using experimental data obtained in the Antarctic after the workshop (see the Recommendations section of the main report), is given in SC/A88/ID43.

Table 1

Approximate sample sizes needed to estimate population sizes of given precision using the Petersen estimator. It is assumed that 75% of animals encountered can be photographed. For more details see text.

Pop. size	CV	No. identified each year	% photographed which are identifiable	Number encountered each year
Fin whales				
10,000	0.5	200	100%	270
	0.1	1,000	100%	1,300
Minke whales				
50,000	0.5	450	50%	1,200
	0.1	2,200	50%	6,000
100,000	0.5	630	50%	1,700
	0.1	3,200	50%	8,400
500,000	0.5	1,400	50%	3,800
	0.1	7,100	50%	18,900

Annex E

Sampling Strategies used in some Major Photo-identification Studies

This Annex summarises some of the current sampling strategies for studies of nine species of mysticetes and four species of odontocetes that use individual photographic identification techniques. It is not intended to be a comprehensive listing.

BOWHEAD WHALE

(1) Bering, Chukchi and Beaufort Seas, particularly near Point Barrow

Compiled by: David Rugh, National Marine Mammal Laboratory, 7600 Sand Point Way N.E., BIN C15700, Seattle, WA 98115, USA.

Platform

Aircraft (Twin Otter).

Sampling Period

Mid-April to June during migration past Pt. Barrow August-September and during summer feeding in Beaufort Sea.

Objectives

Population size estimation, reproduction, survivorship, demographics and behaviour.

General

Dates of aerial photographic sampling are chosen to fit within the expected period of the migration past Pt. Barrow from mid-April to early June. Low densities of whales provide low or no returns for aerial efforts, so flights are timed to coincide with periods when several whales can be found per flight (2–3 hours each).

Two thorough seasons may be adequate to accomplish a single population estimate, but budget, weather, logistical and technical considerations limit effort in some seasons and are beyond the control of research workers. Many years or decades of effort may be required for obtaining good reproductive or survivorship data, whereas behavioural data may be obtained in one season.

Sampling Strategy

Aerial transects offshore from Pt. Barrow provide an estimate of the width of the migratory corridor. Reports from the census conducted by the North Slope Borough also help shape temporal sampling effort. Flights are targeted to areas where whales are most expected, such as along breaks in sea ice closest to shore. Multiple passes are made over each group of whales until adequate photographs have been obtained or the animals sound. For studies in the Beaufort Sea, flights are along tracklines designed to maximise chances of finding whales. Systematic tracklines done in other studies help find whale concentrations. Typical search altitude is 1000 ft., while

photographs are taken at 300–600 ft. Minimum flight speed (about 80 mph) is attempted by flying into the wind just above stall speed. Weather conditions, water turbidity, dense sea ice, and funding limitations restrict sampling effort.

Comments

No major improvements are needed if the full theoretical program can be carried out. Handheld cameras are superior to fixed cameras in aircraft. Computerised data entry systems are excellent, but should not cripple a project when the computer is inoperable.

RIGHT WHALE

(1) North Atlantic Scotian Shelf to Florida

Compiled by: Scott Kraus, New England Aquarium, Central Wharf, Boston, Mass. 02110, USA.

For: The North Atlantic Right Whale Consortium (Univ. of Rhode Island, Center for Coastal Studies, Woods Hole Kodachrome 200, Ektachrome 400 and HP5 or Tri X black Oceanographic Inst.).

Platform

Vessels and aircraft.

Objectives

Population size estimation, reproduction, survivorship, demographics and behaviour.

General

Scotian Shelf efforts (July-October) and Bay of Fundy (July-October) efforts use vessels and aircraft. Systematic tracklines are modified by continuous sightings per unit effort analyses. Cape Cod and Massachusetts Bay efforts (March-May, Center for Coastal Studies) use vessels and fixed tracks to focus on habitat use and feeding strategies. Great South Channel efforts (April-June, Univ. of Rhode Island) use aircraft and some vessels, systematic aerial tracklines and some randomised surveys to focus on distribution abundance and feeding. Southeast U.S. coastline efforts (January-May) use aircraft, systematic tracklines from Savannah, Georgia, to Miami, Florida, and out to 20 miles.

Photographs from boats are taken with 80–210 mm zoom and 300 mm fixed-focus lenses of right and left sides of right whale heads, callosity patterns, lip ridges, birth marks and scars. Dorsal and ventral flukes are also photographed. Kodachrome 200, Ektachrome 400 and HP5 or Tri X black and white films are used.

Sampling Strategy

Systematic tracklines supplemented with opportunistic efforts.

Comments

Inconsistent aircraft configuration, attraction to large surface-active groups and differences between research workers in different groups are sources of variability. Efforts have been repeated over periods of years, giving opportunity for sequential improvements. Photographic efforts are needed in the Gulf of St. Lawrence, Newfoundland, Greenland and Cintra Bay, Spain.

(2) Southern Ocean coasts of Brazil, Uruguay and Argentina, particularly Peninsula Valdez

Compiled by: Roger Payne, Vickie Rowntree and Jose Truda Palazo, Long Term Research Institute, 191 Weston Road, Lincoln, MA 01773, USA.

Platform

Aircraft, cliff-tops, small boats.

Sampling Period

Whales are present June-December, but funding limits sampling to September-October. Samples less than three years in length are not useful.

Objectives

Reproduction, survivorship, demographics and behaviour.

Sampling Strategy

Complete surveys of the 495km coastline of Peninsula Valdez are done by air, circling at 300ft and photographing callosity patterns while recording time and group location. Aerial photographic surveys off the Brazilian coast are also done to determine range of population found off Valdez.

Comments

Some aspects of behaviour have been well documented, but others need more work. Good information on reproduction and fair information on migration have been obtained. About 40% of population is known to age and sex. The sampling period is too short to determine survivorship reliably. Comparisons between years are limited by variability of effort.

(3) Southern Ocean, South Africa

Compiled by: Peter Best, Whale Unit, c/o South African Museum, PO Box 61, Cape Town 8000, South Africa.

Platform

Helicopter.

Sampling Period

Once per year, mid-October for 2-3 days. Sampling period coincides with peak abundance of whales on the coast and (hopefully) with end of calving. Sampling period is deliberately limited to ensure comparability between years and to maximise return with limited funding.

Objectives

Population size estimation, reproduction, survivorship, demographics.

Sampling Strategy

Flights cover the same area of coast in the same configuration each year. This area covers the distribution of about 90% of mothers and calves on the South African

coast. Photography is limited to cow-calf pairs, because they are the only classes fully represented in coastal waters at this time and photography of such pairs maximises information return per photograph, since sex and maturity of the adult are known and the calf is a known age animal. Helicopter manoeuvrability allows all animals to be photographed. The same number of frames (11-12) are taken of each pair and three standard views (dry head, wet head and dry back) are attempted for each animal. Water clarity and helicopter endurance (2.5hr) main problems.

Comments

Sources of uncertainty include whether all calves have been born before the sampling period, whether some females habitually calve earlier or later than the sampling period. Monthly surveys, funding permitting, would eliminate these uncertainties. Funding limitations are severe. Major improvements to sampling have been use of extra fuel stores for extending surveys and calibration of 250mm lens for more accurate focusing. The 9 year sampling period is not yet sufficient to estimate average age at first parturition. Another 3 years of effort may be needed for that. Another 3-6 years may allow adult survival rate estimation. Population growth rate estimation was not originally an objective, but the data appear to be useful for indication of population growth trends.

(4) Southern Ocean, Southwestern Australia

Compiled by: John Bannister, Western Australian Museum, Francis Street, Perth WA 6001, Australia.

Platform

Aircraft.

Sampling Period

Late austral winter-spring (August-October), three days/mo. animals present July-November, sampling coincides with maximum abundance. Cost limits period.

Objectives

Population size estimation, reproduction, survivorship, demographics and behaviour.

Sampling Strategy

Flights along coastline cover areas where animals congregate, within 1 mile of shore. Survey length, 600n.miles, was originally chosen to cover maximum likely area of local 'stock'. Aircraft flies beachline with observers searching seaward. Highway monoplane (*Cessna 172* or *185*) flies at 1500ft, 100kt with 2 persons, pilot/observer and observer/photographer. Winds less than 15kt, calm to low swell, good to excellent visibility are required. Whales are circled at 300-600ft, counted and photographed. Constraints include availability of pilot, photographer, aircraft and good weather. Funding limits flights to 1/mo now, although 2/mo were possible up to 1986.

Comments

A major question is the extent to which population is closed. Some animals are known to travel between and beyond eastern and western limits of the study area. Complementary surveys are now being conducted to the east along S. Australian coast to link up with present efforts. W. Coast cannot be covered under present funding availability. Survey was originally designed only to count

animals, rather than photograph them. Limited flight time and necessity to get to the few landing/refuelling sites limits opportunity for photographic work. Work should continue beyond 1990 to permit estimates of age at first parturition.

GRAY WHALE

(1) Eastern North Pacific

Compiled by: Jim Poole, Southwest Fisheries Center, NMFS, P.O. Box 271, La Jolla, CA 92038, USA and John Calambokidis, Cascadia Research Collective, Waterstreet Bldg., Suite 201, 218 1/2W. 4th Avenue, Olympia, WA 98501, USA.

Platform

Vessels and shore stations.

Sampling Period

Year round; January-April in Baja breeding lagoons, December-May along California coast during migration, April-November from California to British Columbia portions of feeding range.

Objectives

Population size estimation, reproduction, survivorship, demographics and behaviour.

Sampling Strategy

During migration, sampling from shore of animal migrating past station and near-shore small boat surveys are used. During summer and autumn feeding period small boats are used near shore. In the breeding lagoons line transects through the lagoon are done in small boats.

Comments

There is no single coordinated or dedicated effort to photo-identify gray whales. Photo-identification of gray whales from aircraft is possible, but has not been used extensively.

BLUE WHALE

(1) California (Gulf of Farallones and Monterey Bay)

Compiled by: John Calambokidis, Cascadia Research Collective, Waterstreet Bldg., Suite 201, 218 1/2W. 4th Avenue, Olympia, WA 98501, USA.

Platform

Small boats and commercial whale watching boats.

Sampling Period

June-November, corresponding to the main period when whales are present off California, although earlier sightings have recently been found. Poor weather limits sampling in some areas.

Objectives

Population size estimation, reproduction, survivorship, demographics and behaviour.

Sampling Strategy

Sampling is currently limited by funding constraints and blue whale photo-identification is done incidental to studies on humpback whales. Effort from whale-watch trips or nature trips is helpful but variable. Effort is

currently identifying only a small proportion of the population and at least several additional years of effort will be needed to allow quantitative examination of movements between areas and estimation of population sizes. Direction of effort to locations of highest whale concentrations maximises identifications that can be made with available effort.

Comments

Agreed upon categories for pigmentation, a uniform grading system for photographs and improved quality of photographs are all needed.

(2) Gulf of St. Lawrence and Sea of Cortez

Compiled by: Richard Sears, Mingan Island Cetacean Study, 285 Green Street, St. Lambert, Quebec, J4P 1T3, Canada.

Platform

Outboard-powered inflatable boats and sailboats (40'-60').

Sampling Period

May-November (G.St.Lawrence) and March-May (Sea of Cortez).

Objectives

Population size estimation, reproduction, survivorship, demographics and behaviour.

Sampling Strategy

Daily trips to known areas of concentration in the Mingan Islands area of the Gulf of St. Lawrence are done with as many hours of effort as weather and gasoline allow. Longer range trips throughout the Gulf of St. Lawrence range from the Saguenay River to the Strait of Belle Isle. Because the emphasis is on behaviour, photo-identification is a very important aspect of our work. Emphasis is on inter and intra-species interactions and habitat use.

Comments

Expansion of the field season to May-November has provided better information by increasing the chances of 'catching' individuals. Regular sampling effort at Mingan assures continuity in year to year data. Use of sailing vessels has expanded range of the sampling area. More systematic transect-type sampling could be employed on occasion to test sampling efficiency and other bias.

FIN WHALE

(1) Western North Atlantic

Compiled by: Beverly Agler, Allied Whale, College of the Atlantic, Bar Harbor, Maine 04609, USA.

Platform

Inflatable boats and 15-50m whalewatch vessels.

Sampling Period

April-October, 1974-1987 with most effort 1981-1987.

Objectives

Population size estimation, reproduction, survivorship, demographics and behaviour.

Sampling Strategy

Transect sampling and additional sampling of more areas would be important improvements, but funding restrictions make them unlikely. Collaborators include Provincetown Center for Coastal Studies, Atlantic Cetacean Research Center, Mystic Aquarium, Okeanos Ocean Research Foundation and Mingan Island Cetacean Study.

SEI WHALE**(1) Southern Gulf of Maine**

Compiled by: Phil Clapham, Center for Coastal Studies, Box 1036, Provincetown, MA 02657, USA.

Platform

30m commercial whaling vessels.

Sampling Period

Mid-April to November, limited by operation of vessels.

Objectives

Population size estimation, reproduction and demographics.

Sampling Strategy

Opportunistic effort in rare years when species is present. Effort is entirely opportunistic, and there is no control over area searched.

Comments

Given the 'capricious' nature of sei whale distribution or presence in this survey area, it will be difficult to conduct long-term studies aimed at assessing population parameters. Not enough is known about this animal in the study area to design a proper sampling program.

BRYDE'S WHALE

(1) Gulf of California (Canal de Ballenas 1982–1986; Loreto, Sergio Flores and Luis Fleischer, 1987–1988; La Paz, Jorge Urbán, 1988); W. Coast South Africa (Peter Best, 1987)

Compiled by: Bernie Tershy, Moss Landing Marine Laboratories, P.O. Box 450, Moss Landing, CA 95039–0450, USA.

Platform

Boats. Small skiff 12–15 feet. No large boats.

Sampling Period

Most effort is incidental to other studies described in this Annex.

Objectives

Habitat use, residency patterns, social behaviour and approximate population size.

Sampling Strategy

All photographs are opportunistic except for Canal de Ballenas and Loreto work, where quantifiable and consistent, but non-random, sampling is done. In the Canal de Ballenas daily trips were directed to locations with greatest chance for photographing whales. Most of the study area was covered weekly. After 1983 emphasis was

placed on photographing whales with distinctive markings. Photographic effort usually continued until each individual and all associated whales were photographed during each sighting. Evasive or 'hard to photograph' whales were often not photographed in order to avoid harassment and to optimise use of research time. Species of *Balaenoptera* most rare in the previous month received preferential attention. Cow-calf pairs were preferentially sampled.

Comments

Sampling strategy is not optimal for estimation of population size, reproduction, survivorship or demographics. Those were not the primary questions that the Gulf of California project was addressing. More money and additional boats would have allowed better sampling.

MINKE WHALE**(1) San Juan Islands, Washington State, USA**

Compiled by: Eleanor Dorsey, Long Term Research Institute, 191 Weston Road, Lincoln, MA 01773, USA.

Platform

Small outboard motor boats.

Sampling Period

June–September, because minke whales are most numerous then and weather is best for sampling. Whales are still present in October, but weather is limiting. Study requires 3–5 years to achieve objectives.

Objectives

Behaviour – feeding ecology.

Sampling Strategy

Four main feeding locations in San Juan Islands were identified from incidental sightings and trial and error. All locations were visited as weather and time permitted and individuals were followed as focal animals for variable lengths of time. Attempts were made to identify all animals in an area. Occasional searches of other areas were made.

Comments

Sampling works well for study objectives. Researchers had trouble finding any animals at all before they located the four feeding locations. For other objectives, such as population estimation or delimitation of home ranges, some other sampling strategy would be necessary.

HUMPBACK WHALE**(1) California and Mexico**

Compiled by: Ken Balcomb, 1359 Smugglers Cove Road, Friday Harbor, WA 98250, USA.

Platform

Small outboard-powered boats, 14m Trimaran.

Sampling Period

California-1986,1987,1988; 6 weeks each year. Three year period selected to allow triple-catch mark-recapture population estimate.
Mexico – 1988, 1989, 1990, 6 weeks each year in winter.

Objectives

Population size estimation, demographics, substock structure.

Sampling Strategy

Project assumes Gulf of Farallones and Central California contains one closed feeding 'population' where individuals randomly forage in the Farallones sanctuary area. Whales are located by aerial survey, then found using boats for photography of flukes. As many whales are photographed as possible. Mark-recapture population estimates are done between years.

Comments

Assumptions of 'closed population' and equal 'catchability' of individuals are not certain. Improvement could be achieved by expanding range of study to evaluate 'closedness' of population. Results need to be evaluated statistically to test for randomness.

(2) Auau Channel, Hawaii

Compiled by: Debbie Glockner-Ferrari, Center for Whale Studies, 1728 San Luis Road, Walnut Creek, CA 94596, USA.

Platform

Inflatable boat and underwater observations by snorkelling at surface.

Sampling Period

1975–present, mid-January to mid-May from 1977–present.

Sampling Strategy

The project focuses on identification and sexing of mothers, calves and escorts, but also includes identification of whales observed in other types of groupings such as surface active groups, pairs, singles etc. The whales are located by observations from the coast and also using a CB communication network with whalewatch vessels, fishing boats and dive boats. Emphasis is placed on observing individuals over a long period within one day as opposed to photographing as many individuals as possible. The study objectives are focused on determining reproductive rates and calving intervals, therefore sampling is not random. Observations of individuals are made not only from the surface, but also below it.

Comments

The combination of underwater and surface observations is extremely effective in obtaining data on the reproductive cycle and behaviour of this species. A gentle approach to the whales is extremely important when working with mothers and calves. Caution must be exercised when photographing resting mothers and calves or they will move out of an area and perhaps experience stress that could affect survival of calves.

(3) Hawaii and Southeast Alaska

Compiled by: Scott Baker, National Cancer Institute – Frederick Cancer Research Facility, Building 560, Room 21–105, Frederick, Maryland 21701–1013, USA.

Platform

Inflatable boats and small outboard boats.

Sampling Period

January-April in Hawaii, June-September in Alaska.

Sampling Strategy

This project attempts to collect photographs from as many animals as possible in most years. In Hawaii, however, the focus was on behavioural studies in some years. In Hawaii, sampling is generally confined to the islands of Hawaii or Maui, though all islands were sampled in some years.

Comments

Samples in Southeast Alaska are large in most years, but collected only in portions of the regional habitat. Some sample years received lower sample efforts in both Hawaii and Alaska. Relative sample size in Hawaii is still only a small proportion of the seasonal population, perhaps only 10–20% each year. Across all years, however, regional samples are substantial.

(4) Southeastern Alaska, including Glacier Bay National Park

Compiled by: Jan Straley, PO Box 273, Sitka, Alaska 99835, USA.

Platform

Small, 5–7m, inflatable and fibreglass skiffs, powered with outboard motors.

Sampling period

Southeastern Alaska – Year-round with emphasis on fall and winter. Glacier Bay National Park – June– September each year.

Objectives

Population size estimation, migration, demographics, reproductive histories, feeding strategies, behaviour.

Sampling strategies

Survey routes are determined from reported sightings. If no reported sightings, a systematic route schedule is followed. Surveys are not usually conducted in the same area on consecutive days so as to minimise potential impact monitoring may have upon the whales. If more than one pod is encountered a quick observation of the estimated number of whales and pods is done from a distance. The pods are then approached one by one beginning from the closest pod and working to the farthest away pod. While approaching one pod the other pods are monitored as to their position and movements. An individual whale is not approached longer than one hour per day. The overall sampling strategy is to obtain as many fluke identification photographs as possible, especially cows and calves.

Comments

Sampling effort is not consistent throughout southeastern Alaska. Most of the effort is concentrated in the northern southeastern Alaska during late spring and summer. Effort in the fall and winter is sporadic due to inclement weather and limited daylight.

(5) Palmer Peninsula, Antarctica

Compiled by: Steven Katona, College of the Atlantic, Bar Harbor, MA 04609, USA.

Platform

Inflatable boats and research vessels.

Sampling Period

Austral summer, 1986.

Objectives

Migration and population substock structure.

Sampling Strategy

Whales were photographed by Greg Stone (College of the Atlantic) and William Hamner (University of California at Los Angeles) opportunistically in calm waters nearshore or between ice masses. Small boats were useful in these situations. Right whale photographs were compared with the catalogue of photographs maintained by Roger Payne at the Long Term Research Institute and are available to other scientists. Humpback photographs were compared with the North Atlantic Humpback Whale Catalogue at College of the Atlantic and are available to other scientists.

(6) Southern Gulf of Maine; West Indies

Compiled by: Phil Clapham, Center for Coastal Studies, Box 826, Provincetown, MA 02657, USA.

Platform

Gulf of Maine – 30m commercial whalewatching boats, 12m research vessel, 16m auxiliary ketch, inflatables; West Indies – 16m auxiliary ketch, inflatables.

Sampling Period

Year round in southern Gulf of Maine, daily mid-April to November using whalewatching vessels. Different behaviours require different lengths of study. West Indies work occurs January-March annually.

Objectives

Population size estimation, reproduction, survivorship, demographics and behaviour.

Sampling Strategy

As many individuals are photo-identified as possible. Whalewatch cruises are entirely opportunistic. Research vessel cruises are non-random, directed to areas of whale abundance, but often cover areas where whales are not abundant. Photo-identification work is often incidental to other studies. Sampling design is also constrained by contract requirements for some project work, but photo-identification work is done opportunistically whenever possible. Census transects for humpback whales only are carried out in the West Indies. As many identifying photographs are taken as possible while the boat is not on census transect. Funding constraints cause variability in effort between seasons.

Comments

Constraints on sampling prohibit reliable abundance estimation for southern Gulf of Maine study area. Use of a primary research vessel on survey tracks and simultaneous

deployment of inflatable boats for photo-identification work is a useful method for increasing the photographic pool while simultaneously estimating abundance.

(7) Mexican Pacific

Compiled by: Jorge Urbán, Autonomous University of Baja California sur; Anelio Aguayo and Carlos Alvarez, Autonomous University of Mexico.

Platform

Small boats (pangas, inflatables).

Sampling Period

January-March (Mainland coast); January-April (Baja southern coast); mid-February to mid-May (Revillagigedo Islands); all year (Gulf of California).

Objectives

Migration and substock movements; population size estimation, reproduction, survivorship, demographics and behaviour.

Sampling Strategy

Although some random effort is made, most boat trips are directed toward obtaining the largest number of photo-identification photographs possible and also recording the songs of whales.

Comments

Effort is not homogeneous in all years and at all locations, but the number of photo-identified whales, about 400, is considered to be a good sample for some of the objectives. The number of available boats and the cost of photographic materials and fuel have limited the scope of studies.

SPERM WHALE**(1) Galapagos Islands, Sri Lanka, Azores**

Compiled by: Hal Whitehead, Dalhousie University, Halifax, NS, Canada, B3H 4J1 and Jonathan Gordon, Department of Zoology, University of Cambridge, Downing Street, Cambridge.

Platform

10–14m auxiliary sail.

Sampling Period

January-June (Galapagos), sampling done in two-week periods at sea; January-March (Sri Lanka); May-September (Azores). Two data years are sufficient for some objectives, but several more years of high effort are needed for most objectives to be met.

Objectives

Structure and stability of groups, population size estimation, reproduction, survivorship, demographics and behaviour.

Sampling Strategy

All whales encountered in the vicinity are photographed in order to study group structure. Since it is important to stay with groups as long as possible, fewer total animals can be photo-identified than would otherwise be the case.

Comments

Sperm whales are most easily found and followed acoustically. It is more profitable to concentrate on flukes, photographing from behind, than to concentrate on dorsal fins and photograph from the side. Flukes are easier to identify in large samples, even though fins are easier to obtain. Ideally, photographs of both fluke and dorsal fin should be taken for the same animal.

KILLER WHALE

(1) Within 5 Mi of shore in British Columbia – Washington State Coast. Two core areas are recognised in the resident form: Haro Strait and Johnstone Strait; at some time during each summer all individuals enter both areas. No core area exists for the transient form.

Compiled by: Michael Bigg, Department of Fisheries and Oceans, Pacific Biological Station, Nanaimo, BC, Canada V9R 5K6.

Platform

Small boats (5–6m) with inboard or outboard motors.

Sampling Period

Mainly July–September and opportunistically at other times. Approximately 30–40 field days per year are needed in each core area to determine population size for the resident form. Study has been underway since 1973.

Objectives

Births and deaths in each year, demographics and behaviour.

Sampling Strategy

Two strategies are used to study the resident and transient forms of killer whales: 1) to wait in core areas for whales to arrive and to find them by searching or relying on sightings from volunteers; and 2) to wait at the lab until volunteer observers notify by telephone that a pod has been seen near shore; a boat is then trailered to the closest launching ramp and deployed.

Comments

Sampling strategy is routine now after 14 years. Work should continue to monitor population parameters, behaviour, movements, social organisation, lineage, and stock differentiation. If skin biopsies can be taken without disturbing individuals, much can be learned about the validity of lineages derived by association analysis, as well as establishment of paternities and stocks.

BOTTLENOSE DOLPHIN**(1) Southern California, San Diego County**

Compiled by: Larry Hansen, Southeast Fisheries Center, Miami Laboratory, 75 Virginia Beach Drive, Miami, FL 33149, USA and R.H. Defran, Cetacean Behaviour Laboratory, San Diego State University, San Diego, CA 92183, USA.

Platform

5m outboard powered skiff.

Sampling Period

1981–1988, year around.

Objectives

Demographics and behaviour (including Site Fidelity).

Sampling Strategy

Since these dolphins occur in scattered groups within 1/4 of the coast, survey vessel runs a transect parallel to coast, about 100m or less offshore. Dolphins are photographed when encountered until it is believed an adequate sample is collected. Good photographs have been obtained using 35mm cameras, 400mm f 4.5 lens, and *Kodachrome 64* or *Tri-X* black and white films.

Comments

No measure of photographic sampling effort is currently available. It is difficult to sample all individuals when groups are larger than about 30 animals. The sorting system of Defran and Schultz (SC/A88/P4, based on ratio of distance between tip of dorsal fin and notches, improved sorting efficiency and decreased sorting time.

(2) Central West Coast of Florida, Primarily Shallow, Protected, Inshore Waters

Compiled by: Randall Wells, University of California, 100 Shaffer Road, Santa Cruz, CA 95060, USA.

Platform

Small outboard powered boats.

Sampling Period

This is a long-term (1970–present) study of resident dolphin communities. Censuses and behavioural observations have occurred at various times throughout the year. The single most important factor in choosing censuring periods is the reproductive season. Censuses before and immediately following the summer calving season provide information on births to identifiable females, and calf survivorship during the first year of life. Minimum censuring period is 1–2 weeks of daily boat surveys.

Objectives

Population size estimation, reproduction, survivorship, demographics and behaviour.

Sampling Strategy

During the 1970s, effort concentrated on identifying home ranges and social association patterns of the resident dolphins through tagging, radio tracking, and observations of naturally-marked dolphins. This work also created a situation in which the proportion of readily recognisable individuals was much greater than would have been available from natural markings alone. The study area was selected because of its location near the home laboratory. The size of the study area was based on the empirically determined home range of the resident dolphin community.

During the 1980s the project used information on home ranges and social associations derived from photographic identification efforts to define the ranges and membership of adjacent resident dolphin communities. Once the stability of the geographical limits and membership of the most-thoroughly-studied community were defined, it was possible to monitor population parameters for the community. Census routes were established to provide thorough coverage of the home range, and photographic identification surveys were conducted several times each

year, as funding allowed. Additional information on demographics and genetic structure of the community relative to adjacent communities were obtained from capture-sample-release efforts during 1984-present. The capture-release program also provides opportunities to mark dolphins that might otherwise be considered unmarked from photographs.

Information on presence/absence and births is obtained directly from censuses. Survivorship information is obtained both from censuses in the home range and outside, and from examination of beach stranded carcasses.

Comments

The current sampling strategy has evolved over the past 18 years. For the sake of consistency in between-year comparisons, sampling will probably continue as is. Suggested improvements might include: (1) increased survey coverage outside of the home range to identify emigrations in order to factor these out of 'disappearances'; (2) increased use of DNA fingerprinting to identify animals that are beach stranded in comparison with samples from prior live captures; and (3) more frequent surveys during the year to allow for better estimations of birth rates, as well as to provide additional opportunities to monitor changes in fin characteristics.

SPINNER DOLPHIN

(1) Kona Coast, Hawaii

Compiled by: Randall Wells, University of California, 100 Shaffer Road, Santa Cruz, CA 95060, USA.

Platform

Small boats and cliff-based theodolite tracking stations.

Sampling Period

Continuous sampling during May, 1979, through October, 1980, and again during June 1981.

Objectives

Population size estimation, reproduction and behaviour.

Sampling Strategy

Work takes place from a base in Kealake'akua Bay. All shore-based identifications were from a cliff over this bay. Photographic identification efforts were primarily for the purpose of examining the social structure of these animals. Calculation of a population size estimate from mark-recapture techniques and calculation of a rough reproduction estimate from percentage of calves observed were secondary to the compilation of a catalogue and resightings for social association studies. Boats moved close to shore, where spinner dolphins rest during daylight hours, and photographed as many individuals as possible when schools were encountered. School size was up to 200 animals. Sampling was limited geographically and did not cover the entire range of individuals observed. Sampling was limited by sea conditions and boat size, funding and availability of harbours for safe mooring or refuelling.

Comments

Opportunistic observations and resightings of a tagged individual indicated that at least some of the recognisable dolphins ranged around the entire coast of the Big Island, while most vessel work was limited to a relatively small section of the Kona coast. Additional funding, field time and larger sampling vessels would be necessary to expand the sampling program. Individually-identified animals along the Kona coast appeared to have core areas within their overall ranges, though there was much mixing between core areas of defined, stratified sampling within core areas could be done using photo-identification and population estimates could be prepared after correcting for mixing between areas.

Additional photo-identification work offshore of the island of Hawaii (Big Island) and at other locations would allow assessment of the hypothesis of non-mixing between spinner dolphins using the Big Island for resting and dolphins using other areas.

Reproductive rates were estimated from crude photogrammetry during regular aerial surveys around the entire coast of the Big Island. More sophisticated photogrammetric techniques exist that could greatly refine these estimates.

BAIJI (CHINESE RIVER DOLPHIN, *Lipotes vexillifer*)

(1) Middle and lower reaches of Yangtze River

Compiled by: Zhang Xianfeng, Inst. of Hydrobiologie Sinica and Gao Anli, Nanjing Normal Univ.

Platform

Research ship, small fishing boats and land. 8m fishing boat with 12HP outboard.

Sampling Period

March 1986-December 1987. Best sample period has not yet been evaluated. A period of 5-10 years of study may be required.

Objectives

Population size estimation and monitor, reproduction, survivorship, behaviour, migration and home range.

Sampling Strategy

Since these studies are just beginning, exact strategies are not in place. The small size and shy behaviour of this species and complex environment of Yangtze River make collection of data difficult. As few as 300 individuals remain alive, which will be a further constraint to sampling.

Comments

Important information on migration range, home range, group structure, and exchange between groups can be obtained through photo-identification. These data will be essential for management plans. Data sufficient for population estimation will require longer. It is better that photo-identification should be combined with other techniques, such as radio-tracking.

Annex F

Collection and Storage of Biopsy Samples

BIOPSY DART

All current models are cylindrical core samplers and range in size from about 7mm to 1cm in diameter and 2cm to 5cm in length. For DNA analysis a minimum sample size of 200mg of skin (including both epidermal and dermal layers) is recommended. The dart diameter required to achieve this will depend on skin thickness for the subject species. If the skin is about 8mm thick, the dart should be about 8mm in diameter.

A biopsy dart should effectively penetrate the skin and retain the sample without remaining embedded. Retention of the sample can be achieved with three inpointing barbs or the use of a 'butterfly' valve. Proper stopping and expulsion are achieved with a wide (2cm to 4cm) metal base and in some cases the addition of a rubber pad.

PROJECTION EQUIPMENT

Although a variety of projection devices have been used, including a modified harpoon gun and spear gun, for most species compound-bows or crossbows provide adequate range. A 25 pound-test compound bow with hollow core fibreglass arrows is sufficient in some cases, for example on killer whales (Hoelzel and Amos, 1988) and gray whales (Mathews, Keller and Weiner, 1988) at a range of 10–20m. For humpback whales a 100 or 150 pound-test bow and metal arrow shaft has been used at a range of 10–30m (SC/A88/ID28). To avoid disturbing the subject, the strength of the bow should be adjusted to the minimum necessary to give sufficient range and ensure expulsion from the sampling site.

RETRIEVAL

In some cases it is necessary to use a retrieval line attached to the dart, for example when working from a large, high-decked ship. Independent flotation should be used in preference to a tethered line to avoid entanglement. The flotation should be a light material (such as cork sealed with a rubberised paint) attached to the arrow shaft just behind the dart.

STERILE TECHNIQUE, PROCESSING AND STORAGE

Before firing, the dart should be immersed in alcohol, flamed and re-immersed to minimise the risk of infecting the wound. For cell culture the sample is removed from the dart with a sterile implement and the dermal papillary layer is sectioned with a sterile scalpel. This layer is then placed in sterile tubes containing culture media with antibiotics and is stable for up to 12 hours if kept cool but not frozen (SC/A88/ID28). Processing samples in locally sterile conditions (SC/A88/ID28) or a portable plexiglass box with arm ports at the sides will help minimise contamination (see Mathews *et al.*, 1988).

For longer storage and transport, cryopreservation following the field methods described in Mathews *et al.* (1988) are recommended. The dermal papillary sample should be scored and replaced in a small cryotube containing culture media with antibiotics and 10% DMSO (dimethylsulphoxide) at 4°C for approximately 2 hr. The sample is then placed in the vapour phase (the upper position of the storage case) of a liquid nitrogen dry-shipper for 1 hr to allow gradual freezing. The sample can then be stored indefinitely in the dry shipper or larger liquid nitrogen freezer.

Samples to be used for DNA analysis (for example the remaining epidermal layers if the dermis is used for tissue culture), should be scored with a scalpel, immersed in a saturated salt solution and frozen as soon as possible (though salt preservation alone is sufficient for up to one month). Use of a 20% DMSO solution saturated with salt will improve preservation. Sterile techniques are not critical at this stage.

Blubber samples and skin to be used for enzyme electrophoresis should be frozen under liquid nitrogen. Blubber to be used for toxicology studies should be cleaned according to standard procedures (IWC, 1986) and frozen in containers approved by the US Environmental Protection Agency, or similar.

REFERENCES

- Hoelzel, A.R. and Amos, W. 1988. DNA fingerprinting and 'scientific whaling'. *Nature, Lond.* 333:305.
- International Whaling Commission. 1986. Report of the Working Group on Whale Habitats and Pollution. *Rep. int. Whal. Commn* 36:134–7.
- Mathews, E., Keller, S. and Weiner, D.B. 1988. A method to collect and process skin biopsies for cell culture from free-ranging gray whales (*Eschrichtius robustus*). *Mar. Mammal Sci.* 4(1):1–12.

Annex G

Procedure for Push Processing *Kodak* and *Ilford HP5* Film

Elwood Miles

Miles Photo Lab, Nanaimo, British Columbia, Canada, V9S 3R5

INTRODUCTION

Kodak Tri-X and *Ilford HP5* films are commonly used in photo-identification studies of cetaceans. Frequently these films are exposed and developed at a higher rating than the recommended 400 ASA, such as 800, 1200 or 1600 ASA. Using a higher ASA permits increased photographic depth of field and increased camera shutter speed. Such underdeveloped film has optimal contrast, detail and grain only when it is custom processed. However, little information is published on how to push process these films. This Annex describes a process which was established empirically by R. Nelson, Nanaimo, British Columbia and which I used for five years in developing film of killer whales, humpbacks and gray whales. *Kodak T Max 400* film can be processed by this procedure but the film does not provide as much subject detail under low light conditions when exposed at 1600 ASA as do *Kodak Tri-X* and *Ilford HP5* films.

1. PREPARATION OF CHEMICALS

Except where noted, all chemicals and rinses should be kept at 20°C.

(a) Developer

This solution is prepared in the necessary quantity immediately before use and is used only once. For each 35mm roll of film to be developed, dissolve 15ml of sodium sulphite photographic grade in 300ml of water at 20°C. Stir briskly. Add 20ml of *Edwal FG7 Developer*. Stir in gently to avoid disturbing any undissolved sulphite. Chemical reaction will have raised the temperature to the working temperature of 21°C.

(b) Stop bath

Add 10ml of *Kodak Stop Bath* to 1000ml of water, stir in and bottle. This quantity is sufficient to process three reels of film at once in one tank. This solution can be re-used.

(c) Fixer

This can be used several times and should be returned to its storage bottle and tested before it is used again. Add 250ml of *Ilford-Ilfospeed Fixer* to 750ml of water, stir in and bottle. This quantity of solution will cover three rolls at one time.

(d) Hypo-clearing agent

A hypo-clearing agent is needed to reduce the time for washing the film. Add 30ml of *Edwal 4 and 1 Clearing Agent* to 1000ml of distilled water, stir and bottle.

(e) *Kodak Photo Flo* Solution

This solution or *Edwal LFN Solution* can be used to help the water drain off the film. Add one or two drops of one of the above solutions to about 600ml of distilled water. Place in a container that is large enough to hold at least one of the film reels.

2. DEVELOPING THE FILM

(a) Developer

Load the film on reels in complete darkness and place the film in the development tank, which could hold 1–3 reels. Securely fasten the light seal and turn on the lights. Add 300ml of developing solution per reel at 21°C. Do not allow any sulphite residue to be added. Start the timer. Place the watertight lid on the tank. Invert the tank five times by rolling the wrist for a total of five seconds, rap the bottom of the tank firmly on the counter three times to remove air bubbles from the film. Repeat the inverting and rapping procedure after 30sec. and one min. and then repeat the inverting procedure alone every 30sec. without rapping for the remainder of the time. The times are 6.5 min. for 400 ASA, 8 min. for 800 ASA, 9 min. for 1200 ASA and 10 min. for 1600 ASA. At the end of the development time drain off the used developer into the sink.

(b) Stop bath

Immediately add the stop bath using 300ml per reel. Invert the tank with the lid in place every 10sec. for 30sec. and drain into storage bottle. Rinse the film by adding water to the tank, agitate for 30sec. and drain.

(c) Fixer

Add 300ml of the fixer solution per reel. Do not use lesser amounts. Agitate by inverting the tank once every 15sec. for 1.5 min. and then drain the solution back into the storage bottle. Remove the tank cap and light seal and inspect the film to be sure that it has cleared. Replace the seal and rinse in water for 30sec. and drain.

(d) Hypo-clearing agent

Add 300ml of this agent per reel. Agitate once every 15sec. for 1.5 min., then drain the solution back into the storage bottle. Add rinse water.

(e) Water rinse

Turn on the hot water tap and run it into the sink until the water reaches about 50°C. Now adjust the hot and cold water taps to produce a constant 20°C. Let the water run freely into the developing tank for five minutes with the light seal in place. Regularly monitor the temperature to keep it at 20°C = ±1°C.

(f) Photo Flo rinse

Place the developed film (still on the reel) in the solution and spin backward and forward for 30sec. without breaking the water surface. Rap the container on the counter to release air bubbles.

3. HANGING AND DRYING

When the *Photo Flo* rinse appears to be free of bubbles, remove the film from the reel, attach film clips top and bottom and inspect the emulsion surface to be sure that no bubbles are present. If bubbles are present, hand dip the film through the rinse or use a hand syringe of *Photo Flo* solution to wash the bubbles off the film. Hang the film and with a piece of clean paper towel wipe the shiny side of the film to remove water. Use a continuous motion top to bottom. Hang the film in a warm location free from dust and air currents. Do not handle the film until it is completely dry. The emulsion side should never be touched.

4. MISCELLANEOUS POINTS

- (a) The strength of the fixer solution should be checked before each use. To do this take a piece of exposed, undeveloped film of the same type as to be processed and place it in the fixer solution. The film should clear within 30sec. If it does not, replace the stop bath, fixer, clearing agent and *Photo Flo* solutions.
- (b) Care must be taken to use the recommended times and temperatures. Sudden changes in temperature will damage the emulsion and produce an effect similar to excessive grain.
- (c) Extra development time will increase contrast if necessary.
- (d) If the process produces too much contrast, first reduce the amount of agitation during development and then if necessary reduce the development time by 30sec.

Annex H

Genetic Assessment of Effective Population Size

The 'effective population size' (N_e) is the average number of individuals that contribute genetically to the subsequent generation. It is especially important to know N_e to conserve populations at a level that maintains genetic diversity and minimises the risk of inbreeding depression. Lack of diversity could deny a species the necessary flexibility to respond to a changing environment over evolutionary time. Inbreeding is detrimental to the fitness of individuals. The following is a very brief review of the methods available for estimating N_e . For a more complete discussion please refer to Hoelzel and Dover (1989).

N_e can be estimated if the number of males and females in a population, and their reproductive variances are known. The most difficult variable is usually male reproductive variance. In particularly well documented populations, this can be estimated by extending known maternal genealogies with paternity testing by DNA fingerprinting.

If it is not feasible to assess the reproductive success of a number of males in a population by directly tracing genealogies, male reproductive variance can be estimated by measuring allele frequencies in the population of males

of reproductive age, and comparing the variance among adult males with the variance in paternal alleles among offspring. If the variance among offspring is very much less than that among reproductive males, then this would suggest a polygynous system where a few males are achieving most of the matings.

A long-term estimation (an average over evolutionary time) can be obtained through the analysis of mitochondrial DNA (mtDNA). Given the assumption that most mutations in the mitochondrial genome are effectively neutral point mutations accumulating at an average rate (for mammals) of about 2% per million years, N_e can be estimated by measuring the genetic distance between at least 20 randomly chosen individuals. This procedure is described in more detail in section 3.3 of Hoelzel and Dover (1989).

REFERENCE

- Hoelzel, A.R. and Dover, G.A. 1989. Molecular techniques for examining genetic variation and stock identity in cetacean species. *Rep. int. Whal. Commn* (special issue 11):81-120.

Annex I

Details of Recommendations Requiring IWC Funding

Annex I1. PROPOSAL FOR FURTHER DEVELOPMENT AND INITIAL COMPILATION OF THE NORTH ATLANTIC FINBACK WHALE CATALOGUE

Curation facility : College of the Atlantic, Bar Harbor, ME 07609

Fin whales, *Balaenoptera physalus*, are a species of special concern to the IWC. At present the North Atlantic fin whale catalogue is in its early stages. This proposal requests funding to further develop and implement methods to photographically identify fin whales. Techniques are available which allow the identification of individuals, but they need further refinement to be used to catalogue the number of individuals in the population. This project would establish cataloguing procedures, database

design and management. It would also provide for the coordination of the compilation of six small regional catalogues (an additional 300–500 individuals and approximately 2,000 photographs) and their associated databases. Although all collaborators have already agreed to contribute photographs, compilation and further development of techniques has been delayed due to lack of funding. £9,000 is required.

Annex I2. WORKSHOP ON THE GENETIC AND BIOCHEMICAL ANALYSIS OF TISSUE SAMPLES COLLECTED BY BIOPSY SAMPLING AND OTHER MEANS

1. Introduction

It is proposed that the IWC sponsors a 3–4 day workshop for 15–20 participants on the collection of tissue samples from cetaceans and the subsequent analysis of those samples. The areas of expertise represented by participants should include, the collection of tissue samples in the field, the preservation and transport of tissue for various types of analyses, recombinant DNA analysis of samples, and the interpretation of genetic variation for the conservation of populations. It is estimated that the workshop would cost between £10,000 and £15,000.

2. Sample collection

There are three essential components to the apparatus used for the remote collection of biopsy samples (collection device, projection and retrieval), and numerous designs have been suggested for each.

2(a) Collection device

Various devices have been tested or proposed. Most designs are cylindrical core samplers, sharpened at the leading edge and including internal barbs or other devices for sample retention. Experience to date suggests that the best design will depend on application and the subject species. The design of appropriate apparatus for the various applications will greatly benefit from discussions among those experienced in their use. It will be useful to further integrate these discussions with participants who have experience with the preservation, required quantity and type of tissue needed for subsequent analyses.

2(b) Projection device

Projection equipment has included modified harpoon guns, spearguns and various types of bows. The choice of equipment is usually dependent on required range, accuracy, and the effectiveness of dart deflection. Further considerations for future designs should include portability and adjustable projection velocity.

2(c) Retrieval

Existing retrieval systems include a line tether and fishing reel, and independent floatation. These systems could be optimised to minimise the risk of entanglement and loss of sample.

Further discussion on sample collection could include methods for sampling entrapped animals and the preferred tissues to sample from stranded animals.

3. Sample preservation

The preservation of tissue for DNA analysis will require different and less stringent conditions than the preservation of live tissue for tissue culture. Both techniques are presently being perfected in various labs. Further, different types of DNA analysis optimally require different levels of stringency. The success rate for the storage and transportation of tissue samples to a lab for tissue culture is currently fairly low. A discussion of techniques used in different labs and under different field conditions would be very useful.

4. Genetic analysis

There are currently numerous laboratories investigating various genomic regions for their structure and variability. These genomic components include ribosomal DNA which has been suggested to be useful for stock identification, mini-satellite regions which are useful at least for the identification of individuals, kinship and paternity, and mitochondrial DNA which can trace the movements of females and estimate genetic distance between populations. These components have been discussed by Hoelzel and Dover (1989). It is clear, however, that there are numerous additional possibilities being developed in other labs, and that a discussion of the possible application of various techniques would be extremely useful. This would be especially true for special applications, for example when only very little or very degraded material

was available. Further, other kinds of information, for example sex, may now be able to be determined by similar analyses of the same tissue samples.

5. Storage and interpretation

The appropriate methodology for the long-term storage of samples including extracted DNA and tissue cultures should be discussed. Methods will vary to some extent with the analytical techniques used. If possible a technique should be developed that incorporates sufficient stringency to be adequate for all proposed analyses.

The interpretation of data is expected to be a major item for consideration. This would hopefully include an agreement on what kinds of information can be interpreted from various types of results and how results could be effectively compared between labs.

Annex I3. PROPOSAL FOR INITIAL WORK TOWARDS ESTIMATION OF JUVENILE MORTALITY RATE IN NORTH PACIFIC HUMPBACK WHALES

Background

Debbie Glockner-Ferrari and Mark Ferrari have taken over 62,900 surface and underwater photographs of individual humpback whales in the waters off the west coast of Maui, Hawaii during the period from 1975 through 1988. Glockner-Ferrari pioneered the technique of identifying and sexing individual humpback whales based on underwater photographs of body patterns, and is one of the few, if not the only researcher, to use this photo-identification technique extensively. Over 580 adults and 260 calves have been identified based on analysis of the underwater photographs.

Analysis of the surface photographs (that is, the tail flukes) has been of secondary importance in their studies, and full cross-correlated analysis of body and fluke pattern photographs is available at this time only for those photographs taken during 1984–1985.

These researchers and all other major research groups working in the North Pacific in breeding and feeding areas have contributed their fluke photos to the US National Marine Mammal Laboratory's (NMML) centralised fluke photograph collection, and the integrated data set curated by the NMML will provide a synoptic picture of humpback whale movement between feeding and breeding areas. Given the range of data from studies by these researchers and other contributors to the NMML system, it is expected that a collaborative estimate of calf mortality may be produced by comparing presence of individual mothers and calves in Hawaii to their presence in Alaska feeding areas. Because Glockner-Ferrari and Ferrari have specialised in studies of reproduction and mother/calf interactions, any collaborative effort to estimate calf mortality would be incomplete without their data.

In order to integrate their data into the North Pacific collection of humpback whale fluke photographs, it will be necessary to cross-correlate all their body pattern photographs with all their fluke photographs. Fluke data from 1984 and 1985 are already encoded into the NMML humpback whale photo-identification encoding system. Data from 1975–1983 and 1986–1988 will be cross-correlated, and special attention will be paid to body pattern markings as a cross-check on the stability of fluke markings.

Objectives

- (1) Analyse all fluke photographs taken from 1975–1983 and 1986–1988, to identify individuals and determine resighting history.
- (2) Analyse underwater slides depicting body patterns to identify and sex individual whales.
- (3) Cross-reference both catalogues.
- (4) Comparison of resighting histories of known females on breeding ground to obtain complete calving interval data to determine reproductive rates.
- (5) Submit photos to NMML to be encoding into the computerised matching system.

Future analyses

- (1) Possible recognition of calves in subsequent years, which would provide a larger body of known age individuals. Given complete resighting histories, this information will allow estimation of age at sexual maturity.
- (2) Identification and sexing of individuals, including mothers and calves, from sloughed skin samples using DNA fingerprinting techniques.

Timetable

One month: preparation of photographs for processing and photo processing.

Five months: cross-correlation of body pattern and fluke photographic collections; and tabulation of resighting histories from the cross-correlated data set.

Proposed budget

It is requested that the IWC provide funding of £7,500 to Debbie Glockner-Ferrari and Mark Ferrari to offset costs of data analysis and photographic reproduction. It is also requested that the IWC provide £2,500 to the US National Marine Mammal Laboratory to encode and extensively cross-match this particular data set in preparation for a larger scale analysis of this and other contributed data sets. Results of this cross-matching will lead to a collaborative analysis of estimates of calf mortality.

Future studies

Data tabulated as the result of this study will be a large component of a future study on calf mortality of humpback whales in the North Pacific. The large scale analysis of calf

mortality will be the result of collaborations between these researchers and others who have contributed photographs to the NMML centralised collection. Future analysis will go forward pending completion of this work.

Annex I4. PROPOSAL – AN INVESTIGATION OF THE FEASIBILITY OF COMPUTER MATCHING OF PHOTOGRAPHS OF CETACEAN NATURAL MARKINGS

Phil Lovell

Conservation Research Group, PO Box 114, Cambridge CB4 1YJ, UK

and Lex Hiby

Sea Mammal Research Unit, c/o BAS, High Cross, Madingley Road, Cambridge, CB3 0ET, UK

A recent study of grey seals has demonstrated that photographs of the head and neck region can be matched on the basis of pelage markings and that the matching can be achieved automatically using a microcomputer (SC/A88/ID9). By automating the matching process the effort involved in using natural markings can be greatly reduced, allowing the techniques to be extended to larger populations. It may be possible to develop computer matching for some of the cetacean studies in which photographs are currently matched by eye, for example southern right whales, humpback whales and blue whales. It was suggested at the Workshop that the feasibility of such developments should be investigated. We have not

yet had time to consider which approach would be suitable for each species (for example, the use of 3D modelling versus the development of orientation-invariant pattern characterisations). Our proposal is to make a preliminary study of the problems involved in each case and then to develop one or more prototype systems. It is not possible, given a fixed budget and time-scale, to guarantee a fully operational system. However, experience with the seal matching problem suggests that significant progress should be possible within a study period of three months.

Budget : £5,000 salary including overheads + £750 travel expenses

Annex I5. WORKSHOP ON PHOTOGRAMMETRY

The complexity of photogrammetric techniques and proliferation of interest in knowing morphometrics of living whales has resulted in a critical need for respective researchers to exchange information. Discussions are needed to update each other on field methods (such as stereo systems or single camera units mounted on aircraft or boats), laboratory techniques (such as digitisers of frequency distributions of size categories). A workshop with a format and length similar to the present Workshop would be appropriate.

The sooner the meeting occurs, the more benefit there will be for projects about to begin or in their early phases. Costs should be similar to that of the present Workshop.

The estimated cost is based on approximately 30 scientists convened for 4 days, perhaps at the National Marine Mammal Laboratory in Seattle. If a third of these scientists can find their own transportation and lodging, the cost to the IWC will be £20,000.

Annex J

Review of Progress on Recommendations Requiring IWC Funding up to August 1990

G.P. Donovan

Reference	Proposal	Funding *	Progress
Item 11.1 Annex I1	Further development and initial compilation of the North Atlantic Fin Whale Catalogue	<i>£9,000</i>	The proposal was submitted to the 1988 Scientific Committee meeting. It was commended in principle but the Committee recommended that it be resubmitted in 1990 to include all areas of the western North Atlantic (RIWC 39:110). This was done and the revised proposal (SC/41/RP3) was recommended for funding by the Committee (RIWC 40:72). Unfortunately this was not endorsed by the Commission due to the overall financial situation it was in.
Item 11.3 Item 11.5 Annex I2	Workshop on the Genetic and Biochemical Analysis of Tissue Samples (including the effects of photo-identification and biopsy sampling on animals)	£15,000	This proposal was endorsed by the 1989 Scientific Committee meeting and a steering Committee established (RIWC 39:133; 40:48). The meeting took place in La Jolla, California, from 27-29 September 1989. The report of that meeting (SC/42/Rep1) and associated papers will be published in special issue 13. Further discussion on the effects of biopsy sampling on animals is given in Annex J of the 1990 Scientific Committee report (RIWC 41:in press)
Item 11.6 Annex I3	Initial work towards estimation of juvenile mortality rate in North Pacific humpback whales	£10,000	The proposal was revised slightly (RIWC 39:116) before presentation to the Scientific Committee at the 1988 meeting. The Committee recommended that it be funded and this was done. As yet, no final report has been received.
Item 11.7 Annex I4	Investigation of the feasibility of computer matching of photos of cetacean natural markings	£8,750	The proposal was revised slightly (RIWC39:135) before presentation to the Scientific Committee at the 1988 meeting. The Committee recommended that it be funded in full and this was done. The report of the work carried out was presented to the 1990 meeting of the Committee (SC/42/PS5) and will be published in RIWC 41.
Item 11.8 Annex I5	Workshop on Photogrammetry	<i>£20,000</i>	The proposal was discussed at the 1988 meeting of the Scientific Committee. The Committee endorsed the concept of the proposal but agreed that a more detailed proposal was required that justified the need to give high priority to this subject under the Comprehensive Assessment. No plans to hold the Workshop have been made since
Item 11	Ensuring continuation of series of data in long-term studies	£12,000	A proposal to provide one year's funding to continue the series of surveys of right whales off South Africa (SC/40/RP1) was presented to the 1988 Scientific Committee meeting. The Committee recommended this for funding in full and this was done. The report of this work was submitted to the 1989 meeting (SC/41/PS4).
Item 11.1	Archival storage of photographic collections	£4,000	The proposal was discussed at the 1988 meeting of the Scientific Committee. The Committee endorsed the concept of the proposal but did not recommend it for funding 'because data cannot..... be made readily available to Scientific Committee members and financial commitment is for more than one year'.
Item 11.9	Feasibility study of photo-id techniques for SH minke whales	£2,460	The Scientific Committee recommended the funding of a pilot study to look at available photographs and if successful recommended that some ship time on the IWC/IDCR minke whale assessment cruise be allocated. This was done and the results presented in the paper by Joyce and Dorsey published in this volume. In addition, money was allocated in the budgets for the 1989/90 and 1990/91 cruises for such work.

*Funding provided by the IWC is given in normal type. Money requested but not provided is shown in italics.

Note: RIWC = *Rep. int. Whal. Commn*

Annex K

Shooting whales (photographically) from small boats: An introductory guide

Sally A. Mizroch¹ and Michael A. Bigg²

¹ *National Marine Mammal Laboratory, Seattle, WA, USA*

² *Pacific Biological Station, Nanaimo, B.C., Canada*

As photo-identification collections grow and aids such as computerised video matching are increasingly used, great attention must be paid to photographic techniques. For more detail on examination of negatives and prints, see Bigg, Balcomb and Ellis (1986).

Choice of film

For whales that are mainly black, gray and/or white, high speed black and white (B&W) film, such as *Ilford HP-5*, is preferred. Colour slide film generally does not have the detail or latitude to be used on a regular basis for ID work from small boats, although in some cases right whale callosity/cyamid patterns are slightly better defined using a high speed colour film, such as *Kodachrome 200 Professional*. If there is any doubt about which type of film to choose, try shooting B&W and colour side by side or alternately for a few weeks, and then compare ID's and the proportion of good, usable shots.

Once the correct film has been chosen, the components of taking a good ID shot are: framing, focusing, exposure, developing and printing.

Framing and focusing

Before beginning field work with a new species, it is important to examine as many good identification photographs of your species as possible, to train your eye to the detail of the ID image. For example, look at Sears, Wenzel and Williamson (1987) for blue whales, Bigg, Ellis, Ford and Balcomb (1987) for killer whales and Katona, Harcourt, Perkins and Kraus (1980) for humpback whales.

Always shoot some practice rolls on land before going into the field, both to check the camera and to practice fast focusing. If possible, use a fast auto-focus camera, or practice focusing and timing by shooting any fast-moving activities, such as sporting events. Make sure to hold the camera very steady. Under some light conditions, such as haze or fog, you may need to switch from auto-focus to manual focus. Always take a back-up camera system in case the primary system develops any technical problems.

Timing is important when taking an ID shot. Determine the most distinctive ID features of your species, and take photos of those parts when they are most exposed. For example, for killer whales, photograph the saddle patch when it is out of the water (Figs 1a and 1b), not as it first begins to surface (Fig. 1c). With humpback whales, the back will show a pronounced arch or hump as the animal

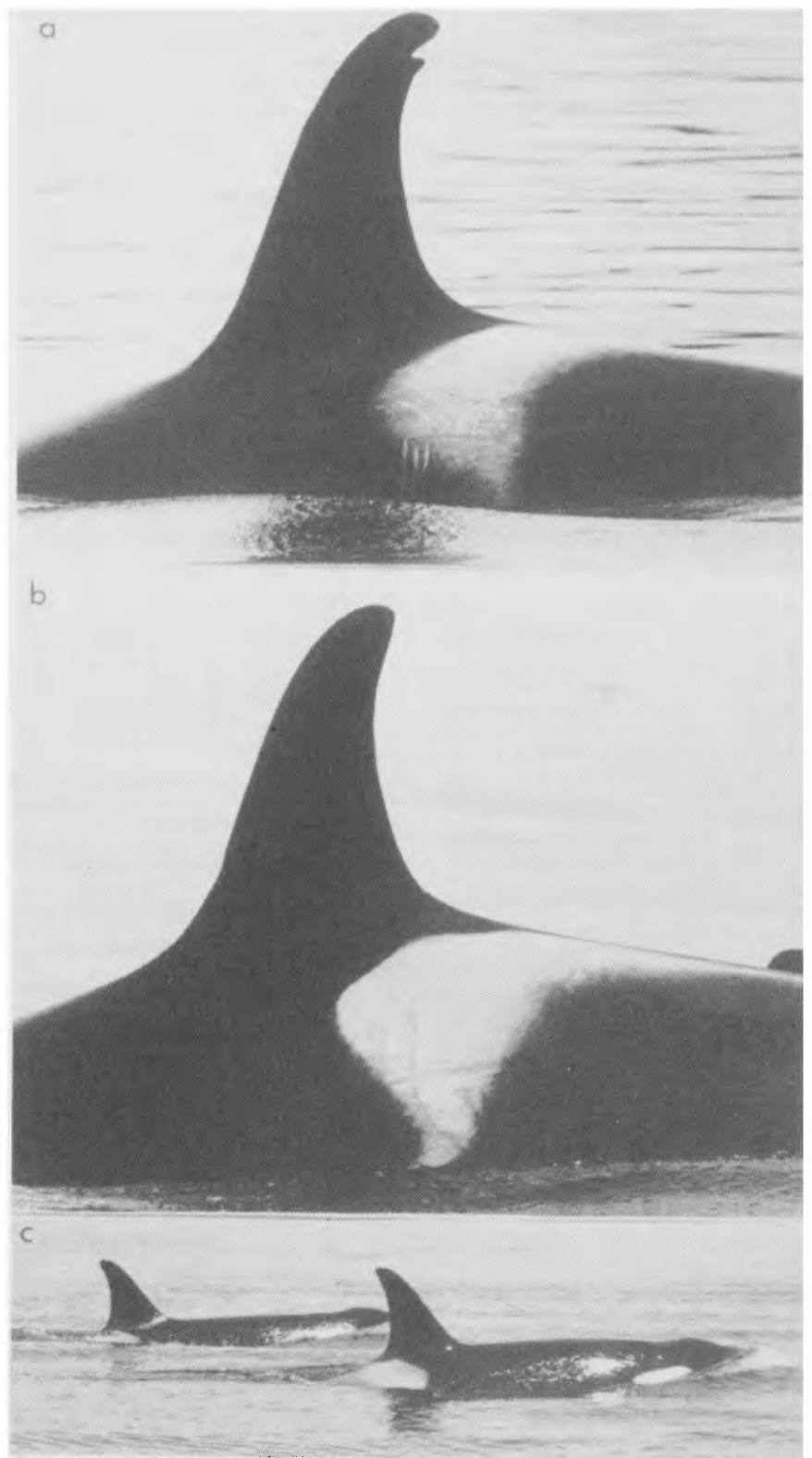

Fig. 1. Example shots of killer whales. a. Whale A2, an adult female with large nick at top, photographed 12 July 1986. b. Whale J12, an adult female with M-shaped scratches on saddle, photographed 21 April 1975. c. Not an ideal shot. Photos a. and b. by G. Ellis, Pacific Biological Station, Nanaimo, B.C., Canada. Photo c. by S. Mizroch.



Fig. 2. Example shots of a humpback whale. a. Note the rake marks on the trailing edge, the open circle on the left fluke, and the numerous lines and spots throughout the fluke. b. Printed from the same negative, but printed too dark. Only a few line scars show. Negative loaned by Cascadia Research Collective, Olympia, Washington, USA.

prepares for a deep dive, then the tail stock will begin to come out of the water. Focus on the caudal area as it rises and take photographs of the tail when the flukes are completely out of the water (Fig 2a). With right whales, take photographs of the crenulations along the lower jaw, post-blowhole callosities, white blowholes, belly and chin pigmentation, mandibular callosity islands, pigmentation, scars, and markings on the flukes, body, tail stock, fluke tips and head. Good photographs of any other unusual features are sometimes enough to make an identification within a season and often between years.

Exposures

If your study is to be carried out from a small boat, as is usually the case, it is important to use as fast a shutter speed as possible to minimise effects of boat and animal movement. Use high speed film, pushed to 800 or 1600 ASA, set the shutter speed at 1/1000 sec or faster, and use as small an f-stop as possible (e.g. in the range from f8-f22) to increase depth of field. Set exposures based on incident light readings from a hand-held meter; because lighting conditions change rapidly, take meter readings fairly often.

Processing

In photo-ID studies, the (photo) negatives are the baseline data, from which all analyses will spring. Therefore, do not take short cuts in processing. If shooting *Ilford* HP-5, use the processing method described in Annex G.

Printing

Commercial labs will generally print negatives for proper exposure of the entire content of the negative. This often results in prints in which the surroundings are well-exposed, usually at the expense of the ID detail of the whale. Fig. 2b gives an example of a typical badly printed ID shot.

A good ID print usually has a background that looks very washed out (Figs 1b, 1c and 2a). If in doubt, print lighter than darker. Use polycontrast paper (e.g. *Kodak* or *Ilford*) and experiment with polycontrast filters to heighten contrast. Ensure that you do not lose fine details by using too high a contrast. For example, a grade 3 polycontrast filter enhanced the details in Fig. 2a, giving a slightly better result than printing without a filter (i.e. grade 2).

Always print for the ID detail of the whale, not for the surroundings. Figs 1b and 1c are printed to show the detail of the indentations and nicks on the dorsal fin, and to show the shape and markings of the saddle patch. Fig. 2a is printed to show the fine lines, rakes, spots, and open circle on the flukes.

ACKNOWLEDGEMENTS

The authors are grateful to Scott Kraus (New England Aquarium, Boston, Massachusetts, USA) and Jan Straley (Glacier Bay National Park, Gustavus, Alaska, USA) for providing details about photographing right and humpback whales. Thanks also to Marcia Muto (NMML) and Greg Donovan for reviewing the text.

REFERENCES

- Bigg, M.B., Balcomb, K.C. and Ellis, G. 1986. The photographic identification of individual cetaceans. *Whalewatcher* 20(2):10-12.
- Bigg, M.B., Ellis, G.E., Ford, J.K.B. and Balcomb, K.C. 1987. *Killer whales. A Study of their Identification, Genealogy, and Natural History in British Columbia, and Washington State*. Phantom Press & Publishers, Inc. Nanaimo, B. C., Canada. 79pp.
- Katona, S.K., Harcourt, P.M., Perkins, J.S., and Kraus, S.D. 1980. *Humpback whales: A Catalogue of Individuals Identified in the Western North Atlantic Ocean by means of Fluke Photographs*. College of the Atlantic, Bar Harbor, Maine, USA. 169pp.
- Sears, R., Wenzel, F.W., and Williamson, J.M. 1987. *The Blue Whale: A Catalogue of Individuals from the Western North Atlantic (Gulf of St. Lawrence)*. Mingan Island Study (MICS, Inc.), St. Lambert, Quebec, Canada. 27pp. + 56 plates.

Field and Laboratory Methodology

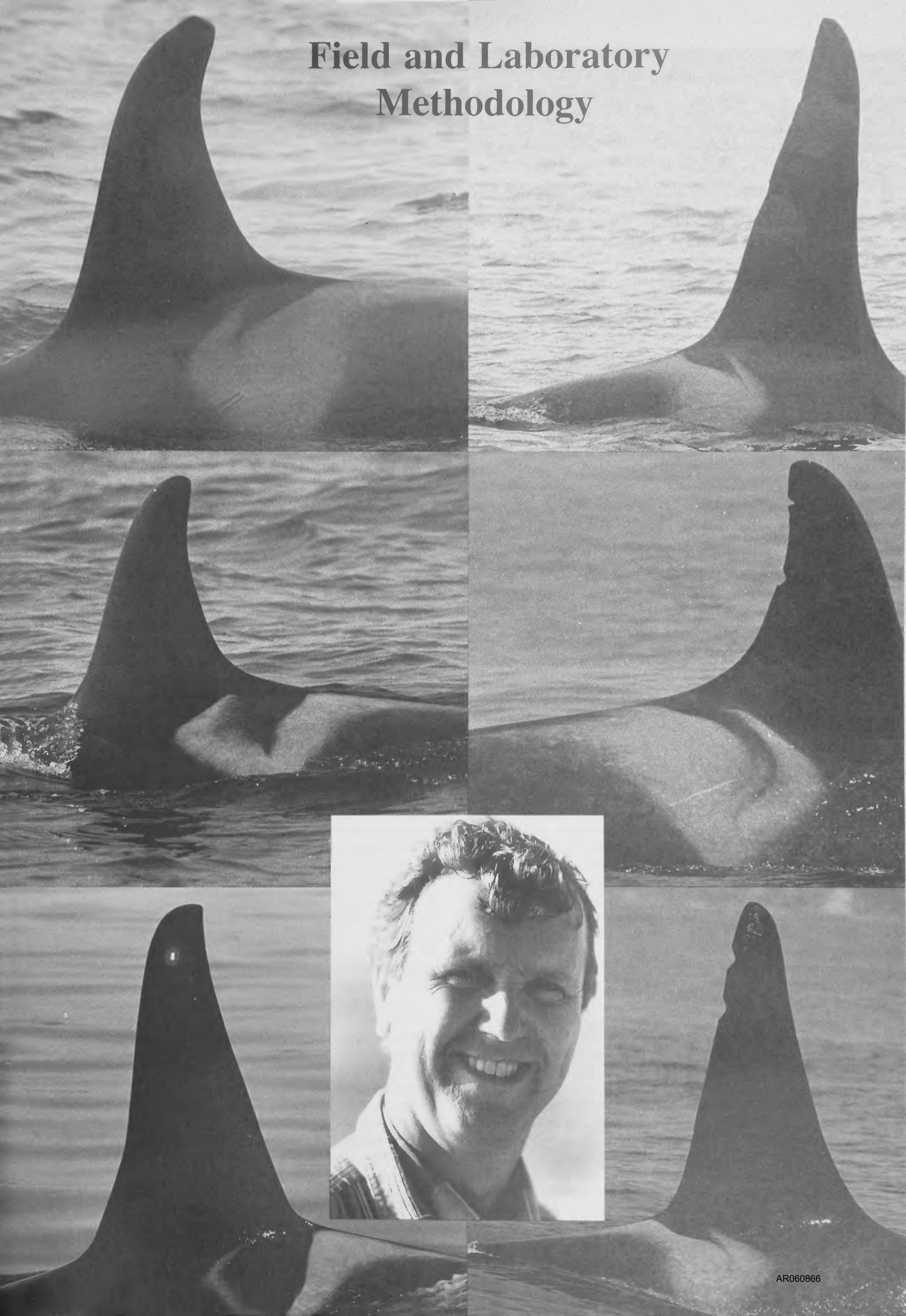

Killer whales from British Columbia—the best studied area in the world. Inset: Mike Bigg, pioneer of this technique for killer whales.

Methods of Photo-Identification for Small Cetaceans

Bernd Würsig and Thomas A. Jefferson

*Marine Mammal Research Program, Department of Marine Biology, Texas A&M University at Galveston,
PO Box 1675, Galveston, TX 77553, USA*

ABSTRACT

Photo-identification of naturally marked cetaceans helps obtain information on group structure, site fidelity, movement patterns and population size. In conjunction with other studies, long-term photo-identification can also enhance descriptions of life history parameters such as age at sexual maturity, calving intervals and reproductive and total life span. Photo-identification can be carried out from shore and boats, with additional information available from airplanes for certain species. Thirty-five millimetre single lens reflex cameras with motor drive, data back and fixed or zoom lenses from 50 to about 300mm are used most often. Film types and storage and retrieval systems vary widely with investigator preference. The technique of photo-identification is powerful and not usually disturbing to wild animals; its refinement and increasing sophistication (such as use with high-resolution video) promise to make it increasingly important in life history and social system studies of small cetaceans.

INTRODUCTION

Historical overview

Early researchers of animal behavior and ecology recognized that aspects of their studies were enhanced by the recognition of individuals. Von Frisch (1962; 1974) marked honey bees (*Apis mellifera*) to study communication about foraging locales; Lorenz (1937) learned to recognize particular greylag geese (*Anser anser*) by natural markings and behavior, as he determined aspects of imprinting. Although artificial marking and tagging was considered almost a prerequisite for behavioral work in the 1950s and 1960s, increasing numbers of long-term studies of wild animals have shown that (especially large and long-lived) vertebrates can usually be identified from natural marks (with the possible exception of most birds, which have, for this purpose at least, the unfortunate tendency to perpetually change their feathers). Zebras, *Equus* sp. (Klingel, 1965; Peterson, 1972), black rhinoceroses, *Diceros bicornis* (Goddard, 1966; Mukinya, 1973), giraffes, *Giraffa camelopardalis* (Foster, 1966), African elephants, *Loxodonta africana* (Douglas-Hamilton, 1973), lions, *Panthera leo* (Schaller, 1972), chimpanzees, *Pan troglodytes* (Goodall, 1986) and bonnethead sharks, *Sphyrna tiburo* (Myrberg and Gruber, 1974), provide examples from the vast literature of studies relying at least in part on knowing who is who in the population. A recent bibliographic compilation of papers which discuss marking and tagging of aquatic animals (Emery and Wydoski, 1987) presents 166 references on 'biological marks' of invertebrates, fish, amphibians, reptiles, birds and mammals – with most emphasis on fish. Individual identification has indeed become a staple of field research, and in the last 15 years or so especially, researchers of cetaceans have begun to take advantage of natural marks. Identification of pinnipeds still relies mostly on tags (e.g. see Peterson and Bartholomew, 1967; Gentry, 1975), but there too the balance may be shifting towards the use of natural markings (e.g. see Hiby and Lovell, 1990).

The casual identification of individual cetaceans has been around for a long time, probably about as long as humans have interacted with coastal species. One example is that of killer whales (*Orcinus orca*) in Twofold Bay,

Australia, in the nineteenth and early twentieth centuries, where whalers and fishermen identified some of at least 27 individuals, apparently mainly by markings on and near the dorsal fin (Wellings, 1944; Mitchell and Baker, 1980). More recently, anomalously white harbor porpoises, *Phocoena phocoena* (McIntosh, 1912; Kleinenberg, 1936), Pacific white-sided dolphins, *Lagenorhynchus obliquidens* (Brown and Norris, 1956; N. Black, Moss Landing Marine Labs, pers. comm.) and bottlenose dolphins, *Tursiops truncatus* (Essapian, 1962; Caldwell and Golley, 1965) have been occasionally seen. Data on 13 species of anomalously white cetaceans were summarized by Hain and Leatherwood (1982). Likewise, Caldwell (1955) had several sightings of a distinctive bottlenose dolphin with a damaged fin, and thus made inferences about the home range of this animal.

The concerted use of often subtle natural marks to study herds or groups of animals in a particular area, however, began over a short period in the early 1970s, with the advent of long-term field studies of live cetaceans. Individuals of killer whales (Balcomb, Boran and Heimlich, 1982; Bigg, 1982), Indo-Pacific humpbacked dolphins, *Sousa chinensis* (Saayman and Tayler, 1973; 1979), bottlenose dolphins (Shane, 1977; 1980; Würsig and Würsig, 1977) and Hawaiian spinner dolphins, *Stenella longirostris* (Norris and Dohl, 1980) were all recognized and cataloged in order to provide information on occurrence and intra-group affiliation patterns (Fig. 1). As far as we can tell, the extensive use of natural marks began for four odontocete species in five widely separated projects all within about a two- to three-year period (without information exchange between the researchers involved) and provides a good example of an idea 'coming of age' due to scientific inertia in the field. At the same time, recognition of humpback whales, *Megaptera novaeangliae* (Katona, Baxter, Brazier, Kraus, Perkins and Whitehead, 1979) and Southern Hemisphere right whales, *Eubalaena australis* (Payne, 1972; 1976; Payne, Brazier, Dorsey, Perkins, Rowntree and Titus, 1983) became an exciting new tool in the study of baleen whales. Today it is recognized that with good enough photographs, a reasonable portion of the population of almost any cetacean species can be individually identified (Table 1 provides a partial list of small cetacean studies which have

Table 1

Studies of small cetaceans in which individuals have been identified by natural markings.

Species	Major distinctive features	Area	Source
Belukha whale, <i>Delphinapterus leucas</i>	Scars on body	Hudson Bay, Canada	Caron & Smith, 1985
Killer whale, <i>Orcinus orca</i>	Dorsal fin shape and nicks, scars on back and shape of light saddle patch	Vancouver Isl., Canada USA Southern Alaska, USA Patagonia, Argentina Iceland Norway	Bigg, 1982; Balcomb <i>et al.</i> , 1982; Balcomb and Bigg, 1986; Bigg <i>et al.</i> , 1987 Leatherwood <i>et al.</i> , 1984; Hall and Cornell, 1986; Ellis, 1987 Lopez & Lopez, 1985 Lyrholm <i>et al.</i> , 1987 Lyrholm, 1984
Short-finned pilot whale, <i>Globicephala macrorhynchus</i>	Nicks, scratches, scars and pigment patterns on dorsal fin and back	Catalina Isl., Calif., USA Japan	Shane, 1984, 1986; Patten & Samaris, 1985 Miyashita <i>et al.</i> , 1990
Indo-Pacific humpbacked dolphin, <i>Sousa chinensis</i>	Scars on flank, back and dorsal fin	Plettenberg Bay, South Africa Moreton Bay, Australia	Saayman & Tayler, 1973, 1979 Corkeron, 1990
Atlantic white-sided dolphin, <i>Lagenorhynchus acutus</i>	Scars and nicks on dorsal fin, and unusual pigment patterns	Gulf of Maine, USA	Belt & Weinrich, 1985; Belt, 1987
Dusky dolphin, <i>Lagenorhynchus obscurus</i>	Scars and nicks on dorsal fin, and unusual pigment patterns	Kaikoura, New Zealand Golfo San José, Argentina	Cipriano, 1985; Würsig, unpubl. data Würsig, unpubl. data
Pacific white-sided dolphin, <i>Lagenorhynchus obliquidens</i>	Scars and nicks on dorsal fin; anomalously white individuals	Monterey Bay, Calif., USA	N. Black, pers. comm.
Bottlenose dolphin, <i>Tursiops truncatus</i>	Nicks, scars, scratches and pigment spots on dorsal fin	Golfo San José, Argentina Western Florida, USA Sanibel Isl., Florida, USA Aransas Pass, Texas, USA Galveston, Texas, USA Matagorda Bay, Texas, USA Mobile Pt., Alabama, USA Southern Calif., USA and west coast of Baja Calif., Mexico Central Calif., USA Gulf of Calif., Mexico Shark Bay, Australia Moreton Bay, Australia Sado Estuary, Portugal	Würsig & Würsig, 1977; Würsig, 1978 Wells <i>et al.</i> , 1980, 1987; Wells, 1986; Irvine <i>et al.</i> , 1981 Shane, 1987 Shane, 1977, 1980 Jones, 1988 Gruber, 1981 Goodwin, 1985; Heimlich- Boran & Heimlich-Boran, 1987 Hansen, 1983, 1990; Kelly, 1983; Defran, Kelly <i>et al.</i> , 1990 Defran, Schultz and Weller, 1990 Wells <i>et al.</i> , 1990 Ballance, 1987 Connor & Smolker, 1985 Corkeron <i>et al.</i> , 1987a,b; Corkeron, 1990 dos Santos & Lacerda, 1987
Risso's dolphin, <i>Grampus griseus</i>	Pigment patterns, nicks on dorsal fin, and scars on back	Monterey Bay, Calif., USA Azorean Isl.	Kruse, 1988 Arnbom <i>et al.</i> , 1988
Spinner dolphin, <i>Stenella longirostris</i>	Scars and marks on dorsal fin	Kona coast of Hawaii, USA	Norris & Dohl, 1980; Norris <i>et al.</i> , 1985
Atlantic spotted dolphin, <i>Stenella frontalis</i>	Fin and fluke marks and body spot patterns	Bahamas	Byrnes <i>et al.</i> , 1989
Heaviside's dolphin, <i>Cephalorhynchus heavisidii</i>	Anomalously white animals, and dorsal fin nicks	Western South Africa	Rice & Saayman, 1984
Hector's dolphin, <i>Cephalorhynchus hectori</i>	Dorsal fin nicks	New Zealand	Slooten & Dawson, 1988; Dawson & Slooten, 1987
Harbor porpoise, <i>Phocoena phocoena</i>	Dorsal fin scars and nicks, and pigment areas	Bay of Fundy, New Brunswick, Canada	Watson, 1976; Watson & Gaskin, 1983; Gaskin & Watson, 1985
Dall's porpoise, <i>Phocoenoides dalli</i>	Dorsal fin pigmentation, color pattern anomalies, and dorsal fin deformities	Monterey Bay, Calif., USA Puget Sound, Wash., USA	Loeb, 1972; Jefferson, unpubl. data Miller, 1990
Baiji, <i>Lipotes vexillifer</i>	Facial coloration patterns	Yangtze River, China	Würsig & Tershy, 1989; Yuanyu <i>et al.</i> , 1990.

sperm whales, *Physeter macrocephalus*; Whitehead and Payne, 1981 for right whales; Gordon, Papastavrou and Alling, 1986 for blue whales, *Balaenoptera musculus*; Heyland, 1974 for white whales, *Delphinapterus leucas*; and Scott, Perryman and Clark, 1985 for pelagic dolphins, *Stenella* spp.). Although it does not require the identification of individuals, measuring the size of known animals can greatly help in ascertaining differential age-sex use of particular areas (Davis *et al.*, 1983) and in establishing growth rates and other life history information over time. A potentially powerful technique is the use of underwater photogrammetry to describe positioning of individuals in dolphin schools in similar vein to work by Klimley (1981) and Klimley and Brown (1983) on scalloped hammerhead sharks (*Sphyrna lewini*).

METHODS FOR SMALL CETACEANS

Distinctive features

For most dolphins and porpoises, the trailing edge of the dorsal fin, which tapers from front to back to a thin sheet of flesh and connective tissue, is the most identifying feature. The area abrades and tatters easily, especially in some species. Populations of bottlenose dolphins, for example, often have greater than 50% of individuals identifiable (Würsig and Würsig, 1977; R.S. Wells, Brookfield Zoological Society, Brookfield, Illinois, pers. comm.), while Hawaiian spinner dolphins (Norris and Dohl, 1980; Norris *et al.*, 1985), dusky dolphins, *Lagenorhynchus obscurus* (Würsig, unpubl. data), pilot whales, *Globicephala macrorhynchus* (Shane, 1984), Dall's porpoises, *Phocoenoides dalli* (Jefferson, unpubl. data) and Pacific white-sided dolphins (N. Black, Moss Landing Marine Laboratories, pers. comm.) typically have only about 20% or less identifiable individuals. Other features which may help to identify individuals include: shape of the dorsal fin; shading of the fin and upper body; scrapes, scratches and wound marks; and pigment patterns. A well-marked individual is one that is recognized not by a single feature, but by a matrix of marks which, in human-related terms, form a distinctive 'face' for the individual. When we rely on one or two simple dorsal fin notches, we may often accidentally lump two or more dolphins as the same individual, and thereby obtain grossly incorrect information on numbers, residency, etc. The senior author is well aware of this potential pitfall, for he has at times made this mistake, until clear and sharp close-up photographs showed detailed markings which allowed for separation of similar-looking animals.

Longevity and changeability of marks is of critical importance to those factors, such as population estimates from mark-recapture studies, which require long-term recognition. There are no hard and fast rules on how long marks last, however. Dorsal fin tatters probably last for life, except that addition of marks near or over a previous mark can obscure identifiability. Bigg, Ellis, Ford and Balcomb (1987) have recognized some killer whales for over 15 years and it is likely that the same can be done for most small delphinids. Wells *et al.* (1987) have recognized several bottlenose dolphins for about 18 years, and Würsig and Harris (1990) have found that some bottlenose dolphin dorsal fins changed not at all over a 12-year period. It is not known, however, whether other individuals changed beyond recognition during that time. Recently, the rate of wound healing has been addressed, especially for bottlenose dolphins (Bruce-Allen and Geraci, 1985;

Lockyer and Morris, 1985; 1990; Corkeron, Morris and Bryden, 1987a). Dolphins heal even large open wounds within a matter of months, but wound scars seem to last for very long times, probably for life. Cookie cutter shark (*Isistius brasiliensis*) bite scars may be found all over the bodies of mature spotted dolphins (*Stenella attenuata*, Würsig, pers. obs.) and spinner dolphins (Jones, 1971; Norris and Dohl, 1980), and it is well known that Risso's dolphins (*Grampus griseus*) accumulate scars throughout life (McCann, 1974 discusses body scarring in sperm whales, delphinids, beaked whales and river dolphins).

Studies from shore

Dolphins which habitually come close to shore may be observed from land, especially where high cliffs or hills provide a good perspective. Land observations and photography do not 'bother' the animals, and that is a great advantage. They are also relatively inexpensive, within the reach of anyone with a camera and telephoto lens. Examples of species which have been studied from shore are bottlenose, dusky, Indo-Pacific humpbacked and Hawaiian spinner dolphins; as well as harbor, Burmeister's and Dall's porpoises (Würsig and Würsig, 1979; 1980; Saayman and Tayler, 1979; Norris *et al.*, 1985; Taylor and Dawson, 1984; Würsig, Würsig and Mermoz, 1977; Jefferson, 1987). However, high vantage points, which are optimal for behavioral observations (and for theodolite tracking, Würsig, Cipriano and Würsig, 1990) are usually not optimal for individual recognition. Only occasionally can aberrant pigment patches on the dorsum of some dolphins be used from high vantage points, and we have found that for most efficient use of dorsal fin patterns and upper body shadings, photographs should not be taken from more than 15m above sea level, nor from further than about 500m from the dolphins (approximately the maximum range with good resolution for a 1000mm lens on a heavy professional tripod). High vantage points are, of course, fine for the large cetaceans such as blue, gray (*Eschrichtius robustus*), bowhead, and right whales, which are identified largely by body markings. Killer whales, with their large dorsal fins and often striking marks, have also been identified from cliffs (Kruse, 1990).

A common procedure is to take photographs of dolphins from the beach with a 300mm lens, preferably but not necessarily on a tripod. A general rule of thumb is to take hand-held photographs at shutter speeds no less than the inverse of the lens size (e.g. using a 300mm lens requires a minimum shutter speed of 1/500s). No lens larger than a 500mm mirror lens should be hand-held. Focus is of critical importance, and it is desirable that a lens is stopped down by at least one f-stop for adequate depth of field. Because dolphins may have different markings on each side of their bodies, ideally one should obtain photographs from each side. This is not always possible because the group may be moving alongshore and may not present their other side. Photographs so obtained should rely mainly on dorsal fin marks which are visible from both sides, although other photos are of course still of value if they can be used for subsequent reidentification of a dolphin from the same side, or can later be linked to a dolphin with both-side photos. Bigg, Ellis and Balcomb (1986) used the convention of making the left side 'most important' for identification of killer whales, but ideally both sides should be photographed if possible. Bottlenose dolphins often behave perfectly for shore photography, since groups patrol certain nearshore areas by going back and forth and

presenting both sides to the patient investigator who may wait for several hours for the group to return. A potential problem with gaining group compositional data over times when the group is out of sight of the investigator is that groups may split up or converge, and composition may change (at times, in rather subtle fashion) during the course of the photo session. In areas where it is possible, an investigator may move along shore with a moving group, and thereby obtain a more thorough documentation of identifiable animals.

Motor-drive 35mm cameras are optimal for field photography, but manual wind cameras are adequate if the investigator learns to rapidly and smoothly advance photo frames as dolphins surface. At certain times when a group of dolphins is relatively small (less than 20) and compact (covering less than about 30m diameter), motor-drive cameras allow for photography of all individuals which surface, and thereby one can obtain data on dive times of known individuals (by linking frames shot to tape-recorded notes in real time), and on affiliations by proximity of surfacings. This rapid-fire photography makes use of the 35mm format to essentially recapture a ciné effect of motion, and the senior author has found the technique of value for shore-based photography of bottlenose dolphins (Würsig, 1978). Non-commercial 8 or 16mm ciné usually does not provide the resolution or high shutter speed required to adequately capture small identifying marks, although recently developed high-resolution video has been found to show most marks of bottlenose dolphins and bowhead whales (pers. obs.)

Studies from airplanes

While shore-based studies are the least invasive and least expensive, airplanes at low altitudes tend to affect the behavior of marine mammals to a larger degree and are expensive. But airplane-based studies are sometimes called for in remote areas and some distance from shore. For example, Payne (1972; 1987) has photographed southern right whales from the air for over 18 years (see also Bannister, 1990; Best and Underhill, 1990), and bowhead whales have more recently been identified from the air as well (Braham and Rugh, 1983; Rugh, 1990). Dolphins, however are usually not individually identifiable from the air, although patterns of associations, and (in clear waters) actual numbers of individuals in a school can be estimated more accurately (Scott *et al.*, 1985). With calibrated equipment and known altitude above water, individual lengths and inter-individual spacings can also be measured (M.D. Scott, Inter-American Tropical Tuna Commission, La Jolla, CA, pers. comm.). Aerial photography should not be attempted with a lens greater than 300mm or at a shutter speed less than 1/250 sec. To prevent distortion, photos should be taken through an open window or through photo-optical glass of a window or a flat-paned airplane belly port, and the lens should not point into the airstream. Unless careful attention is paid to these details, photos taken from the air will usually be disappointing.

A reasonable altitude for behavioral descriptions and photographs which does not affect the behavior of dolphins and whales seems to be about 152m (500ft) for circling single-engine airplanes, and 304m (1000ft) to 457m (1500ft) for larger twin-engine variable pitch propeller planes. This is not a rigid rule, however, for amount of disturbance is greatly affected by depth of water (often more disturbed in shallow water), species, width of circle

around the animals and general behavior. For example, when socializing or feeding, dolphins are often less easily disturbed than when resting or travelling.

Studies from boats

Observations and photographs from boats represent the most practical approach to studying groups of dolphins for the vast majority of species and in most areas. From boats one can find dolphins, move with them and manoeuvre near the group for the best possible view. However, boats are potentially disruptive to the natural behavior of dolphins. Boat operators must learn to approach dolphins slowly, with unvarying motor speed, not to drive through the school, but parallel to the school, and not to turn in front of it; in general, to use common sense so as to minimize herding the school with the vessel. For observational and photographic work, we much prefer a small (<10m), manoeuvrable vessel. This allows a close approach, often to within 5–10m of individuals, and allows for low-angle photography. Fast speeds which prompt most dolphin species to ride the bow and stern waves are to be avoided, as this disrupts normal behavior, and the spray thrown up by dolphins generally obscures the dorsal fin and back. Photos should be taken as perpendicular to the body axis as possible; and for dolphins, the fin and back must generally appear large enough in the frame so that a 1cm nick is visible.

We prefer a variable focal length (zoom) lens for photography from boats, with an approximately 80 to 200mm lens being preferable for most dolphin species. This allows us to rapidly change settings for dolphins which are close to the vessel and for dolphins 20m or more from the vessel. Because of close proximity to most dolphins of a group while manoeuvring near them, it is possible to be selective (when the objectives of the study allow it), i.e. to take photographs of only dorsal fins and backs which appear to have markings. The selective technique saves film (nevertheless, the senior author has been known to take 500 photos of a single group of 10 to 15 animals) and limits identification to less subtle marks which are more likely to result in unambiguous resightings in the future. However, this selective technique may at times miss identifiable dolphins.

There exists a statistical technique to ascertain whether or not every identifiable member of a group was in fact photographed and therefore acknowledged as present. It consists of taking at random, as many photos as possible of members of the group within constraints of time and budget. An *a posteriori* count of at least four identifiable photos per recognizable dolphin indicates that no dolphin was missed in the photo record (with a probability level of 95%). In other words, if 10 recognizable dolphins are identified during a photo session, and at least four photos exist of each, it is likely that there were only 10 identifiable dolphins present (Würsig, 1978; Ballance, 1987; Fig. 2). The technique is powerful, for it can say with high confidence that a particular animal not seen on a particular day was in fact not present. For small dolphin groups, in which each individual may be identifiable, the technique can also give actual group sizes instead of the traditional estimates. The technique is, of course, not limited to boat-based work, but because it requires quite a few photographs taken of dolphins at random, it generally necessitates well over 30 minutes of contact time with dolphins, obtainable by motoring with them.

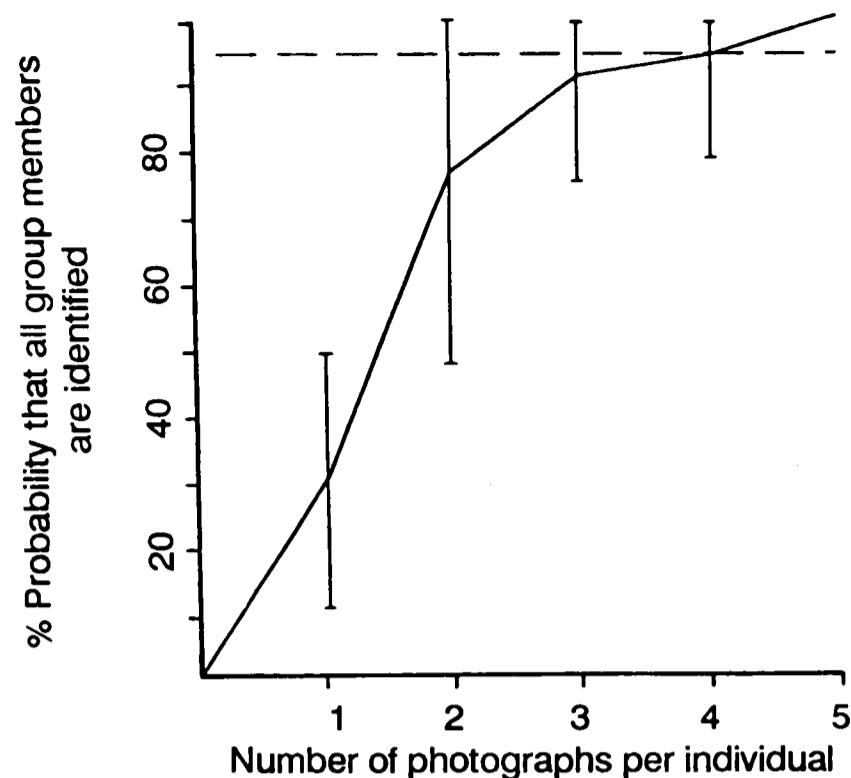

Fig. 2. Percentage probability that all group members are identified plotted against the number of photographs per individual (see text).

Other techniques

Since photography is done from a distance and since many dolphins are sexually monomorphic, it is often not possible to assign sex to particular recognizable animals. It is possible to take advantage of, at times brief, glimpses of the genital area when dolphins roll ventrum up at the surface and when they breach with belly towards the camera. With some experience, it is possible to take the photo of the ventrum and then take a second photo of a recognizable fin or back of the same animal as it presents its usual side to our view. Appropriate annotation of the photo sequences is of critical importance here.

Probably the best manner of rapidly annotating sections of film in the field is to take a picture of a non-dolphin subject subsequent to the important sequence, and note the event into a comment cassette tape recorder or into a field notebook. This is termed 'blanking' the film, and 'blanks' should consist of objects (a cloud, the boat's engine, a colleague, another boat), not a featureless true blank, since a series of such featureless blanks confuses analysis of the film. Blanks can indicate particular sections of groups, size or sex relationships, sequences of film, and any other desired detail. One may think of the 'blank' as being as important as the identification photos.

Underwater photography is another aid to identifying and sexing individuals, but is limited to relatively clear waters. Underwater photographs can be obtained by free diving and by photographing from a vessel with underwater viewing ports (for example, Evans and Bastian, 1969; Norris and Dohl, 1980; Norris *et al.*, 1985). No study has relied heavily on photo-recognition of animals underwater, simply because more clear photos can be obtained above water with less effort. Nevertheless, the linking of photos to sex and inter-animal affiliations, as well as the use of photogrammetry for size and spacing information, mentioned earlier, makes underwater photography a potentially valuable tool for future work (e.g. see Glockner-Ferrari and Ferrari, 1990, working with humpback whales; Byrnes, Black and Leatherwood, 1989, working with Atlantic spotted dolphins, *Stenella frontalis*).

EQUIPMENT, SUPPLIES, AND ANALYSIS

General

We have already mentioned, in general terms, that 35mm cameras with motor-drive capability are appropriate tools. Data backs which electronically print date and time (and sometimes other notes) onto each frame, are also desirable. Many modern cameras have built in 'auto-focus' capability. Some of these auto-focus cameras are remarkably fast and accurate, and reliably focus on even small dorsal fins which subtend only a portion of the 35mm frame. They allow relative amateurs to obtain sharp photographs without the extensive period of self-training normally required to aim, focus and shoot in the about 1 sec. of a dolphin surfacing.

Telephoto lenses used for shore-based photography are generally around 300mm in size although lenses of up to 1000mm have been used (Würsig and Würsig, 1977 used a 1000mm non-mirror lens, f 5.6, for much of their photo-identification of bottlenose dolphins). We have noted that lenses of more than 300mm should not usually be used from airplanes. A wide variety of lenses have been successfully used from boats: from wide angle (we use 24mm) for photographs of bow-riding dolphins, to variable length (zoom) lenses about 80–200mm for most work, up to a maximum of 300mm lenses. The lenses should be as fast as possible without undue weight; an f 4.5 300mm lens is quite appropriate. However a more expensive f 2.8 300mm lens, is probably too heavy for most researchers to comfortably hand hold for extended periods of time, and the gain in lens speed may not be worth the loss in stability.

We suggest the mounting of cameras and long lenses onto commercially available or home-made gun stocks or shoulder braces, which allow for stabilizing the unit with the body, for boat work. The firing mechanism of the camera should be extended to a trigger at the regular position of a gunstock; the hand not at the trigger is used for focussing and f-ring adjustment. Use of such a stabilizing mount depends of course on personal preference, and some researchers believe that the mount adds too much bulk and weight to be worth the effort.

Film types and development procedures

Most large-whale researchers tend to prefer fast films, and commonly shoot ISO 400 *Kodak Tri-X* black and white film at ISO 1600. This necessitates development with special high-speed chemical mixtures such as commercially obtainable *Acufine* or *Edwal FG-7* (Bigg *et al.*, 1986; Hall, Rainer, Reed and Roberts, 1987). *Ilford XP1* and *Ilford HP5* taken at ISO 1600 are also favorite films (Bigg *et al.*, 1986). The fast film speed allows for fast shutter speeds (1/1000 sec., for example) to freeze action (and camera movement), and simultaneously provides for a large depth of field, since f-stop settings can often be adjusted to the lens's midrange, or f 8 to 11. High-speed color film, such as *Kodachrome 200* or *Ektachrome 400*, is less often used.

We find that for dolphin and porpoise photography, a film near or under the speed of ISO 100 is usually adequate for most light conditions. Since marks are often small and subtle, and dorsal fins and backs subtend only a small fraction of most 35mm frames, small grain size and maximal resolution of film emulsion are often necessary, and the faster speed films are sometimes too grainy. We also find that color slide film brings out often subtle differences in body hues and shadings, and our personal choice is *Kodachrome* ISO 64. If color slide film is too expensive for continual use, we recommend any good

black and white film around ISO 100, such as *Kodak Plus-X* (ISO 125) or the new *Kodak T-Max 100* (ISO 100). *Plus-X* can be developed in *Kodak Microdol* solution, thinned one part to three parts water, for fine grain resolution. Color slide film should always be kept handy, however, for those animals with fresh wounds or other color marks. Film may be bought in bulk 16.5 or 33m rolls (one 33m roll fills 18 36-exposure cassettes) and home-rolled to reduce price. We emphasize that our choice of film speeds and types represents a personal bias obtained from experience with often poorly identifiable dolphins. Other researchers prefer to work with faster film speeds even for dolphins, and the choice ends up being one determined largely by personal preference related to particular species.

Storage and analysis

Analysis techniques vary widely among researchers. Many examine black-and-white negatives or diapositive color slides directly through 8-power optical loupes or through variable power dissection microscopes. Others look at proof sheets made from negatives and print promising frames onto 12.5 x 18cm (5 x 7") sheets of photographic paper. We use a combination of methods with black-and-white negative film, examining film through a dissection scope and printing appropriate frames. Slides may also be looked at with a dissecting microscope, but we prefer projection onto a wall, using a slide projector with a zoom lens. This allows us to rapidly trace dorsal fins and backs onto standard sheets of writing paper, and with the variable-power lens, change the size of the image to properly fill the paper. 'Type specimens' of animals are created in this manner, and other photographs are compared to these.

Several workers have developed methods of speeding up manual methods of storing, classifying and matching photographs. Where many different groups work with the same animals (as in killer whale studies in Washington and British Columbia) or where over 1,000 identifications exist (as in humpback whale studies in the North Pacific and Atlantic), computer-assisted retrieval and matching is of great help (e.g. see Hiby and Lovell, 1990; Mizroch, Beard and Lynde, 1990; Whitehead, 1990). Our own dolphin dorsal fins are not computerized mainly because only one or a few people of the same project are dealing with only several hundred identifications.

Whether or not photos are stored by electronic means, the researchers must make decisions on what criteria to use to categorize the many photographs. In humpback whales, a major criterion is the amount and patterning of white on the lower side of the flukes (Katona *et al.*, 1979). For dolphins, we have traditionally used the number and types of dorsal fin notches for filing and retrieval. All single, double and triple notches are filed together; and round, square, or triangular notches are cross-referenced. We have also measured the relative placement of notches top to bottom of the dorsal fin for cross-referencing. Scratches or other fin and body marks are filed separately.

We especially like the technique for analyzing and cataloging dorsal fin photographs developed for bottlenose dolphins by Defran, Shultz and Weller (1990). While these investigators trace negatives or slides onto paper and file them by number of fin notches, as we do, they also create a 'Dorsal Ratio', which consists of measuring the distance between the two largest notches and dividing that by the distance of the lower measured notch to the top of

the fin (Fig. 3). The resultant ratio is unaffected by non-perpendicular placement of the fin in the photograph, and it does not take into account the bottom of the dorsal fin, a location that is difficult to judge in most dolphin species due to the tapering of the fin towards the body. By convention, the top of each notch is used as the measuring point.

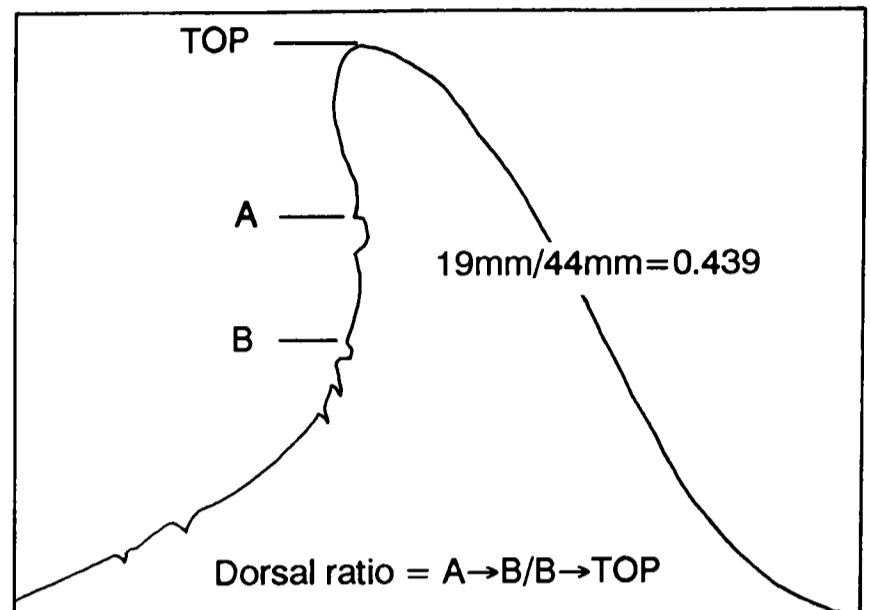

Fig. 3. Dorsal fin tracing and calculation of the dorsal ratio (after Defran *et al.*, 1990).

CONCLUSIONS

We have seen that the requirements for useful identification photographs of the smaller cetaceans are basically the same as those of the baleen and large toothed whales. Dolphins surface much more briefly than whales, however, and the investigator must learn to focus and take pictures very rapidly. Because fin notches and other marks are often relatively small compared to large whale marks, finer-grain films are generally desired (unfortunately, requiring slower speeds).

Photographic identification of cetaceans is a powerful and relatively benign technique which, at least for dolphins, has not yet reached full potential. We wish to see more population estimate studies relying in part on mark-recapture information from photographs. We also believe that at least in some populations, such as with Hawaiian spinner dolphins and bottlenose dolphins in many areas, it is possible to better link identified dolphins to sex and relative age. Photogrammetry will be useful here, and the application of high resolution video, which takes individual frames at up to 1/4000 sec., and thereby eliminates blurring of frames, will allow for frame-by-frame analysis of all dolphins of a group. Video does not presently have the resolving capability of 35mm photography, however, and for subtle notches and marks, cannot yet replace standard still photography. Photo-identification will continue to be facilitated by refinement of existing techniques and by advances in technology. By itself, however, photo-identification will not reach its full potential in providing information on cetaceans. Instead, its use with other data-gathering techniques, such as focal animal studies, capturing animals for blood hormone and chromosome analyses, etc., will allow us to learn ever more about the lives of small cetaceans.

ACKNOWLEDGEMENTS

We thank Sheila Baldrige for assistance in obtaining references, and Myrna Benson for typing and editing numerous drafts. Ken Balcomb and Michael Scott provided helpful reviews of the manuscript. This represents Contribution No. 5 of the Marine Mammal Research Program, Texas A&M University at Galveston.

REFERENCES

- Arnbom, T., Gordon, J., Martins, H., Santos, R. and Walsh, V. 1988. Individual photo-identification of Risso's dolphin near the Azorean Islands. Paper SC/A88/P1 presented at the Symposium on Individual Recognition and the Estimation of Cetacean Population Parameters, La Jolla, May 1988 (unpublished).
- Balcomb, K.C. and Bigg, M.A. 1986. Population biology of the three resident killer whale pods in Puget Sound and off southern Vancouver Island. pp. 85-95. In: B.C. Kirkevold and J.S. Lockard (eds.), *Behavioral Biology of Killer Whales*. Alan R. Liss, Inc., New York. 457pp.
- Balcomb, K.C., Boran, J.R. and Heimlich, S.L. 1982. Killer whales in greater Puget Sound. *Rep. int. Whal. Commn* 32:681-5.
- Ballance, L.T. 1987. Ecology and behavior of the bottlenose dolphin, *Tursiops truncatus*, in the Gulf of California, Mexico. Master's Thesis presented to Moss Landing Marine Laboratories. 96pp.
- Bannister, J. 1990. Southern right whales off western Australia. Paper SC/A88/ID17 (published in this volume).
- Belt, C.R. 1987. Behavior and ecology of the Atlantic white sided dolphin (*Lagenorhynchus acutus*) in the Southern Gulf of Maine.
- Belt, C.R. and Weinrich, M.T. 1985. Life history and distribution of the Atlantic white-sided dolphin in the southern Gulf of Maine - a preliminary analysis. Presented to the Sixth Conference on the Biology of Marine Mammals, Vancouver, Canada, November 1985 (unpublished).
- Best, P.B. and Underhill, L.G. 1990. Estimating population size in southern right whales, *Eubalaena australis*, using naturally marked animals. Paper SC/A88/ID16 (published in this volume).
- Bigg, M. 1982. An assessment of killer whale (*Orcinus orca*) stocks off Vancouver Island, British Columbia. *Rep. int. Whal. Commn* 32:655-66.
- Bigg, M.A., Ellis, G.M. and Balcomb, K.C. 1986. The photographic identification of individual cetaceans. *Whalewatcher (J. Amer. Cet. Soc.)* 20(2):10-12.
- Bigg, M.A., Ellis, G.M., Ford, J.K.B. and Balcomb, K.C. 1987. *Killer Whales: A Study of Their Identification, Genealogy and Natural History in British Columbia and Washington State*. Phantom Press and Publishers Inc., Nanaimo. 79pp.
- Brown, D.H. and Norris, K.S. 1956. Observations of captive and wild cetaceans. *J. Mammal.* 37:311-26.
- Bruce-Allen, L.J. and Geraci, J.R. 1985. Wound healing in the bottlenose dolphin (*Tursiops truncatus*). *Can. J. Fish. Aquat. Sci.* 42:216-28.
- Byrnes, P.E., Black, N.A. and Leatherwood, S. 1989. Photo-identification, behavior and distribution of spotted dolphins (*Stenella frontalis*) in the Bahama Banks. Presented to the Eighth Biennial Conference on the Biology of Marine Mammals, Pacific Grove, California, USA, December 1989 (unpublished).
- Caldwell, D.K. 1955. Evidence of home range of an Atlantic bottlenose dolphin. *J. Mammal.* 36:304-5.
- Caldwell, D.K. and Golley, F.B. 1965. Marine mammals from the coast of Georgia to Cape Hatteras. *J. Elisha Mitchell Sci. Soc.* 81:24-32.
- Caron, L. and Smith, T.G. 1985. Preliminary results on the status and behavior of a hunted herd of belugas (*Delphinapterus leucas*) in Eastern Hudson Bay. Presented to the Sixth Conference on the Biology of Marine Mammals, Vancouver, Canada, November 1985 (unpublished).
- Cipriano, F. 1985. Dusky dolphin research at Kaikoura, New Zealand: a progress report. *Mauri Ora* 12:151-8.
- Conner, R.C. and Smolker, R.S. 1985. Habituated dolphins (*Tursiops* sp.) in western Australia. *J. Mammal.* 66:398-400.
- Corkeron, P.J. 1990. Aspects of the behavioral ecology of inshore dolphins *Tursiops truncatus* and *Sousa chinensis* in Moreton Bay, Australia. pp. 285-293. In: S. Leatherwood and R.R. Reeves (eds.) *The Bottlenose Dolphin*. Academic Press, San Diego. 653pp.
- Corkeron, P.J., Morris, R.J. and Bryden, M.M. 1987a. A note on healing of large wounds in bottlenose dolphins, *Tursiops truncatus*. *Aquat. Mamm.* 13:96-8.
- Corkeron, P.J., Morris, R.J. and Bryden, M.M. 1987b. Interactions between bottlenose dolphins and sharks in Moreton Bay, Queensland. *Aquat. Mamm.* 13:109-13.
- Cubbage, J.C. and Calambokidis, J. 1984. Bowhead whale length measured through stereophotogrammetry. Report to National Marine Fisheries Service, Seattle, Wash. (unpublished). 71pp.
- Cullen, J.M., Shaw, E. and Baldwin, H.A. 1965. Methods for measuring the three-dimensional structure of fish schools. *Anim. Behav.* 13:534-43.
- Davis, R.A., Koski, W.R. and Miller, G.W. 1983. Preliminary assessment of length-frequency distribution and gross annual reproductive rate of the Western Arctic bowhead whale as determined with low-level aerial photography, with comments on life history. Report to the National Marine Fisheries Service, Seattle, Wash. (unpublished). 91pp.
- Dawson, S. and Sooten, E. 1987. The down under dolphin. *Forest and Bird*, November:32-4.
- Defran, R.H., Kelly, D.L., Shultz, G.M., Weaver, A.C. and Espinoza, M.A. 1990. Occurrence and movements of the bottlenose dolphin (*Tursiops truncatus*) in the Southern California Bight. *Mar. Mamm. Sci.*
- Defran, R.H., Schultz, G.M. and Weller, D.W. 1990. A technique for the photographic identification and cataloging of dorsal fins of the bottlenose dolphin (*Tursiops truncatus*). Paper SC/A88/P4 (published in this volume).
- Douglas-Hamilton, I. 1973. On the ecology and behavior of the Lake Manyara elephants. *E. Afr. Wildl. J.* 11:401-3.
- Ellis, G. (ed.). 1987. Killer whales of Prince William Sound and Southeast Alaska: A catalogue of individuals photoidentified, 1976-1986. Sea World Research Institute Tech. Rep. 87-200, 76pp.
- Emery, L. and Wydaski, R. 1987. *Marking and Tagging of Aquatic Animals: An Indexed Bibliography*. U.S. Fish and Wildlife Service, Washington, D.C.
- Essapian, F. 1962. An albino bottlenose dolphin, *Tursiops truncatus*, captured in the United States. *Norsk Hvalfangsttid.* 9:341-4.
- Evans, W.E. and Bastian, J. 1969. Marine mammal communication: social and ecological factors. pp. 425-475. In: H.T. Andersen (ed.), *The Biology of Marine Mammals*. Academic Press, New York, San Francisco, and London. 475pp.
- Foster, J.B. 1966. The giraffe of Nairobi National Park: Home range, sex ratios, the herd, and food. *E. Afr. Wildl. J.* 4:139-48.
- Gaskin, D.E. and Watson, A.P. 1985. The harbor porpoise, *Phocoena phocoena*, in Fish Harbour, New Brunswick, Canada: occupancy, distribution, and movements. *Fish. Bull., US* 83:427-42.
- Gentry, R.L. 1975. Comparative social behavior of eared seals. *Rapp. P.-v. Reun. Cons. int. Explor. Mer* 169:189-94.
- Glockner-Ferrari, D.A. and Ferrari, M. 1990. Reproduction in the humpback whale, *Megaptera novaeangliae*, in Hawaiian waters, 1975-1988: The life history, reproductive rates, and behavior of known individuals identified through surface and underwater photography. Paper SC/A88/ID30 (published in this volume).
- Goddard, J. 1966. Mating and courtship of the black rhinoceros (*Diceros bicornis* L.). *E. Afr. Wildl. J.* 4:69-75.
- Goodall, J. 1986. *The Chimpanzees of Gombe: Patterns of Behavior*. The Belknap Press of Harvard University Press. 673pp.
- Goodwin, D.E. 1985. Diurnal behavior patterns of *Tursiops truncatus* off Mobile Point, Alabama. Master's Thesis presented to San Francisco State Univ. 60pp.
- Gordon, J.C.D. 1990. A simple photographic technique for measuring the length of whales at sea. *Rep. int. Whal. Commn* 40:581-8.
- Gordon, J.C.D., Papastavrou, V. and Alling, A.F. 1986. Measuring blue whales: a photogrammetric technique. *Cetus* 6(2):5-8.
- Gruber, J.A. 1981. Ecology of the Atlantic bottlenosed dolphin (*Tursiops truncatus*) in the Pass Cavallo area of Matagorda Bay, Texas. Master's Thesis presented to Texas A&M Univ. 182pp.
- Hain, J.H.W. and Leatherwood, S. 1982. Two sightings of white pilot whales, *Globicephala melaena*, and summarized records of anomalously white cetaceans. *J. Mammal.* 63:338-43.
- Hall, J.D. and Cornell, L.H. 1986. Killer whales of Prince William Sound, Alaska: Results of 1985 field research. Paper SC/38/SM2 presented to the IWC Scientific Committee, April 1986 (unpublished). 14pp.
- Hall, J.D., Rainer, M., Reed, G. and Roberts, J. 1987. Increasing flexibility in photographic techniques for identifying killer whales. *Cetology* 53:1-7.

- Hammond, P.S. 1986. Estimating the size of naturally marked whale populations using capture-recapture techniques. *Rep. int. Whal. Commn* (special issue 8):253-82.
- Hansen, L.J. 1983. Population biology of the coastal bottlenose (*Tursiops truncatus*) dolphin of southern California. Master's Thesis presented to California State Univ., Sacramento. 104pp.
- Hansen, L.J. 1990. California coastal bottlenose dolphins. pp.403-20. In: S. Leatherwood and R.R. Reeves (eds.), *The Bottlenose Dolphin*. Academic Press, San Diego. 653pp.
- Heimlich-Boran, J.R. and Heimlich-Boran, S.L. 1987. Population estimation and seasonal habitat use patterns of bottlenose dolphins (*Tursiops truncatus*) off the Gulf coast of Alabama. Presented to the Seventh Conference on the Biology of Marine Mammals, Miami, Florida, December 1987 (unpublished).
- Heyland, J.D. 1974. Aspects of the biology of beluga (*Delphinapterus leucas* Dallas) interpreted from vertical aerial photographs. Paper presented to the Second Conference and Symposium on Remote Sensing (unpublished). 8pp.
- Hiby, A.R. and Lovell, P. 1990. Computer-aided matching of natural markings: a prototype system for grey seals. Paper SC/A88/ID9 (published in this volume).
- Irvine, A.B., Scott, M.D., Wells, R.S. and Kaufman, J.H. 1981. Movements and activities of the Atlantic bottlenose dolphin, *Tursiops truncatus*, near Sarasota, Florida. *Fish. Bull.*, US 79:671-88.
- Irvine, A.B. and Wells, R.S. 1972. Results of attempts to tag Atlantic bottlenosed dolphins (*Tursiops truncatus*). *Cetology* 13:1-5.
- Irvine, A.B., Wells, R.S. and Scott, M.D. 1982. An evaluation of techniques for tagging small odontocete cetaceans. *Fish. Bull.* 80:135-143.
- Jefferson, T.A. 1987. A study of the behavior of Dall's porpoise (*Phocoenoides dalli*) in the Johnstone Strait, British Columbia. *Can. J. Zool.* 65:736-44.
- Jones, E.C. 1971. *Isistius brasiliensis*, a squaloid shark, the probable cause of crater wounds on fishes and cetaceans. *Fish. Bull.*, US 69:791-8.
- Jones, S.C. III. 1988. Survey of the Atlantic bottlenose dolphin (*Tursiops truncatus*) population near Galveston, Texas. Master's Thesis presented to Texas A&M University, College Station. 52pp.
- Katona, S., Baxter, B., Brazier, O., Kraus, S., Perkins, J. and Whitehead, H. 1979. Identification of humpback whales by fluke photographs. pp.33-44. In: H.E. Winn and B.L. Olla (eds.), *Behavior of Marine Animals, Vol. 3: Cetaceans*. Plenum Press, New York, London. 438pp.
- Kelly, D. 1983. Photo-identification of bottlenose dolphins in Southern California. *Whalewatcher (J. Amer. Cetacean Soc.)* 17(2):6-8.
- Kleinenberg, S.E. 1936. K vaprosu ob al'binizme u del'finov. *Izv. Akad. Nauk. SSR*. 1936:1305-1310 (in Russian).
- Klimley, A.P. 1981. Grouping behavior in the scalloped hammerhead. *Oceanus* 24:65-71.
- Klimley, A.P. and Brown, S.T. 1983. Stereophotography for the field biologist: Measurement of lengths and three-dimensional positions of free-swimming sharks. *Mar. Biol.* 74:175-85.
- Klingel, H. 1965. Notes on the biology of the plains zebra, *Equus quagga boehmi*, Matschie. *E. Afr. Wildl. J.* 3:86-8.
- Kruse, S. 1988. A photo-identification study of Risso's dolphins in Monterey Bay, California - preliminary report. Paper SC/A88/P12 presented at the Symposium on Individual Recognition and the Estimation of Cetacean Population Parameters, La Jolla, May 1988 (unpublished).
- Kruse, S. 1990. The interactions between killer whales and boats in Johnstone Strait, B.C. In: K. Pryor and F.S. Norris (eds.) *Dolphin Societies: Discoveries and Puzzles*. University of California Press, Berkeley. (In Press).
- Leatherwood, S., Balcomb, K.C., Matkin, C.O. and Ellis, G. 1984. Killer whale (*Orcinus orca*) of southern Alaska: Results of field research 1984, preliminary report. Hubbs/Sea World Research Institute Tech. Rep. 84-175, 59pp.
- Lockyer, C. and Morris, R.J. 1985. Body scars of a resident, wild bottlenosed dolphin (*Tursiops truncatus*): Information on certain aspects of his behaviour. *Aquat. Mamm.* 11:42-5.
- Lockyer, C.H. and Morris, R.J. 1990. Wound healing and persistence of scars in *Tursiops truncatus*. Paper SC/A88/P16 (published in this volume).
- Loeb, V.J. 1972. A study of the distribution and feeding habits of the Dall porpoise in Monterey Bay, California. Master's Thesis presented to San Jose State College. 62pp.
- Lopez, J.C. and Lopez, D. 1985. Killer whales (*Orcinus orca*) of Patagonia, and their behavior of intentional stranding while hunting nearshore. *J. Mammal.* 66:181-3.
- Lorenz, K. 1937. Imprinting. *Auk* 54:245-273.
- Lyrholm, T. 1988. Photo-identification of individual killer whales, *Orcinus orca*, off the coast of Norway, 1983-1986. *Rit. Fisk.* 11:89-94.
- Lyrholm, T., Leatherwood, S. and Sigurjónsson, J. 1987. Photo-identification of killer whales (*Orcinus orca*) off Iceland, October 1985. *Cetology* 52:1-14.
- Major, P.F. and Dill, L.M. 1978. The three-dimensional structure of airborne bird flocks. *Behav. Ecol. Sociobiol.* 4:111-12.
- McCann, C. 1974. Body scarring on Cetacea-odontocetes. *Sci. Rep. Whales Res. Inst.*, Tokyo 26:145-55.
- McIntosh, W.O. 1912. On a white porpoise. *Ann. Mag. Nat. Hist.* 10:117-19.
- Miller, E. 1990. Photo-identification techniques applied to Dall's porpoise, (*Phocoenoides dalli*), in Puget Sound, Washington. Paper SC/A88/P13 (published in this volume).
- Mitchell, E.D. and Baker, A.N. 1980. Age of reputedly old killer whale, *Orcinus orca*, 'Old Tom' from Eden, Twofold Bay, Australia. *Rep. int. Whal. Commn* (special issue 3):143-54.
- Miyashita, T., Kasuya, T. and Mori, K. 1990. An examination of the feasibility of using photo-identification techniques for a short-finned pilot whale stock off Japan. Paper SC/A88/P14 (published in this volume).
- Mizroch, S.A., Beard, J. and Lynde, M. 1990. Computer assisted photo-identification of humpback whales. Paper SC/A88/ID11 (published in this volume).
- Mukinya, J.G. 1973. Density, distribution, population structure and social organisation of the black rhinoceros in Masai Mara Game Reserve. *E. Afr. Wildl. J.* 11:385-400.
- Myrberg, A.A. and Gruber, S.H. 1974. The behavior of the bonnethead shark, *Sphyrna tiburo*. *Copeia* 1974:358-74.
- Norris, K.S. and Dohl, T.P. 1980. Behavior of the Hawaiian spinner dolphin, *Stenella longirostris*. *Fish. Bull.*, US 77:821-49.
- Norris, K.S., Würsig, B., Wells, R.S., Würsig, M., Brownlee, S.M., Johnson, C. and Solow, J. 1985. The behavior of the Hawaiian spinner dolphin, *Stenella longirostris*. Southwest Fisheries Center Admin. Rep. LJ-85-06C, 213pp.
- Patten, D.R. and Samaris, W.F. 1985. Pilot whales of Catalina Island, California. Presented to the Sixth Conference on the Biology of Marine Mammals, Vancouver, Canada, November 1985 (unpublished).
- Payne, R.S. 1972. Swimming with Patagonia's right whales. *Nat. Geog.* 142:576-87.
- Payne, R.S. 1987. Long term behavioral studies of the southern right whale (*Eubalaena australis*). *Rep. int. Whal. Commn* (special issue 10):161-7.
- Payne, R.S., Brazier, O., Dorsey, E.M., Perkins, J.S., Rowntree, V.J. and Titus, A. 1983. External features in southern right whales and their use in identifying individuals. pp. 371-445. In: R.S. Payne (ed.), *Communication and Behavior of Whales*. Westview Press, Boulder, Colorado. 643pp.
- Peterson, J.C.B. 1972. An identification system for zebra (*Equus burchelli*. Gray). *E. Afr. Wildl. J.* 10:59-63.
- Petersen, R.S. and Bartholomew, G.A. 1967. The natural history and behavior of the California sea lion. *Am. Soc. Mammal., Spec. Publ.* 1:1-79.
- Rice, F.H. and Saayman, G.S. 1984. Movements and behaviour of Heaviside's dolphins (*Cephalorhynchus heavisidii*) off the western coasts of Southern Africa. *Invest. on Cetacea* 16:49-63.
- Rugh, D.J. 1990. Bowhead whales reidentified through aerial photography near Point Barrow, Alaska. Paper SC/A88/ID15 (published in this volume).
- Saayman, G.S. and Tayler, C.K. 1973. Social organisation of inshore dolphins (*Tursiops aduncus* and *Sousa*) in the Indian Ocean. *J. Mammal.* 54:993-6.
- Saayman, G.S. and Tayler, C.K. 1979. The socioecology of humpback dolphins (*Sousa* sp.). pp.165-226. In: H.E. Winn and B.L. Olla (eds.), *Behavior of Marine Animals, Vol. 3: Cetaceans*. Plenum Press, New York, London. 438pp.
- dos Santos, M.E. and Lacerda, M. 1987. Preliminary observations of the bottlenose dolphin (*Tursiops truncatus*) in the Sado estuary (Portugal). *Aquat. Mamm.* 13:65-80.
- Schaller, G.B. 1972. *The Serengeti Lion*. University of Chicago Press. 480pp.
- Scott, M.D., Perryman, W.L. and Clark, W.G. 1985. The use of aerial photographs for estimating school sizes of cetaceans. *Inter-American Tropical Tuna Commn. Bull.* 18:383-419.
- Scott, M.D., Wells, R.S., Irvine, A.B. and Mate, B.R. 1990. Tagging and marking studies on small cetaceans. pp. 489-514. In: S. Leatherwood and R.R. Reeves (eds.), *The Bottlenose Dolphin*. Academic Press, San Diego. 653pp.

- Shane, S.H. 1977. The population biology of the Atlantic bottlenose dolphin, *Tursiops truncatus* in the Aransas Pass area of Texas. Master's Thesis presented to Texas A&M Univ. 239pp.
- Shane, S.H. 1980. Occurrence, movements, and distribution of dolphin, *Tursiops truncatus*, in southern Texas. *Fish. Bull.*, US 78:593-601.
- Shane, S.H. 1984. Pilot whales and other marine mammals at Santa Catalina Island, California in 1983-84. Southwest Fisheries Center Admin. Rep. LJ-84-28C, 29pp.
- Shane, S.H. 1986. Detailed observations of a single pod of pilot whales and sightings of other marine mammals at Catalina Island, California in winter 1984-85. Unpubl. manuscript, University of California, Santa Cruz. 49pp.
- Shane, S.H. 1987. The behavioral ecology of the bottlenose dolphin. Doctoral Thesis presented to University of California, Santa Cruz. 97pp.
- Shane, S.H., Wells, R.S. and Würsig, B. 1986. Ecology, behavior and social organization of the bottlenose dolphin: A review. *Mar. Mamm. Sci.* 2:34-63.
- Slooten, E. and Dawson, S. 1988. Studies on Hector's dolphin, *Cephalorhynchus hectori*: a progress report. *Rep. int. Whal. Commn* (special issue 9): 325-38.
- Taylor, C.K. and Saayman, G.S. 1972. A method for determining the composition, development and stability of groups of free-ranging dolphins. *Z. Saugetier Kunde* 37:116-19.
- Taylor, B.L. and Dawson, P.K. 1984. Seasonal changes in density and behavior of harbor porpoise (*Phocoena phocoena*) affecting census methodology in Glacier Bay National Park, Alaska. *Rep. int. Whal. Commn* 34:479-83.
- Von Frisch, K. 1962. Dialects in the language of the bees. *Sci. Am.* 207:78-87.
- Von Frisch, K. 1974. Decoding the language of the bees. *Science* 185:663-8.
- Watson, A.P. 1976. The diurnal behaviour of the harbour porpoise (*Phocoena phocoena* L.) in the coastal waters of the western Bay of Fundy. Master's Thesis presented to the University of Guelph. 93pp.
- Watson, A.P. and Gaskin, D.E. 1983. Observations on the ventilation cycle of the harbour porpoise *Phocoena phocoena* (L.) in coastal waters of the Bay of Fundy. *Can. J. Zool.* 61:126-32.
- Wellings, C.E. 1944. The killer whales of Twofold Bay, N.S.W., Australia, *Grampus orca*. *Aust. Zool.* 10:291-4.
- Wells, R.S. 1986. Structural aspects of dolphin societies. Doctoral thesis presented to the University of California, Santa Cruz. 234pp.
- Wells, R.S. and Scott, M.D. 1990. Estimating bottlenose dolphin parameters from individual identification and capture-release techniques. Paper SC/A88/P23 (published in this volume).
- Wells, R.S., Irvine, A.B. and Scott, M.D. 1980. The social ecology of inshore odontocetes. pp. 263-317. In: L.M. Herman (ed.), *Cetacean Behavior: Mechanisms and Functions*. Wiley and Sons, New York. 463pp.
- Wells, R.S., Scott, M.D. and Irvine, A.B. 1987. The social structure of free-ranging bottlenose dolphins. pp. 247-305. In: H.H. Genoways (ed.), *Current Mammalogy, Vol. 1*. Plenum Press, New York and London. 519pp.
- Wells, R.S., Hansen, L.J., Baldrige, A.B., Dohl, T.P., Kelly, D.L. and Defran, R.H. 1990. Northward extension of the range of bottlenose dolphins along the California coast. pp. 421-31. In: S. Leatherwood and R.R. Reeves (eds.), *The Bottlenose Dolphin*. Academic Press, San Diego. 653pp.
- Whitehead, H. 1990. Fast computer-assisted individual identification of sperm whale flukes. Paper SC/A88/ID42 (published in this volume).
- Whitehead, H. and Payne, R. 1981. New techniques for assessing populations of right whales without killing them. *FAO Fish. Ser. (5) [Mammals in the Seas]* 3:189-209.
- Würsig, B. 1978. Occurrence and group organization of Atlantic bottlenose porpoises (*Tursiops truncatus*) in an Argentine Bay. *Biol. Bull.* 154:348-59.
- Würsig, B. 1979. Dolphins. *Sci. Am.* 240(3):136-48.
- Würsig, B. and Harris, G. 1990. Site and association fidelity in bottlenose dolphins off Argentina. pp. 361-5. In: S. Leatherwood and R.R. Reeves (eds.), *The Bottlenose Dolphin*. Academic Press, San Diego. 653pp.
- Würsig, B. and Tershy, B. 1989. The Baiji: perhaps the most endangered of them all. *Whalewatcher (J. Amer. Cetacean Soc.)* 23(3):3-5.
- Würsig, B. and Würsig, M. 1977. The photographic determination of group size, composition, and stability of coastal porpoises (*Tursiops truncatus*). *Science* 198:755-6.
- Würsig, B. and Würsig, M. 1979. Behavior and ecology of the bottlenose dolphin, *Tursiops truncatus*, in the south Atlantic. *Fish. Bull.*, US 77:399-412.
- Würsig, B. and Würsig, M. 1980. Behavior and ecology of the dusky dolphin, *Lagenorhynchus obscurus*, in the south Atlantic. *Fish. Bull.*, US 77:871-90.
- Würsig, B., Cipriano, F. and Würsig, M. 1990. Dolphin movement patterns: Information from radio and theodolite tracking studies. In: K. Pryor and K.S. Norris (eds.), *Dolphin Societies: Discoveries and Puzzles*. University of California Press, Berkeley. (In press).
- Würsig, M., Würsig, B. and Mermoz, J.F. 1977. Desplazamientos, comportamiento general y un varamiento de la marsopa espinosa, *Phocoena spinipinnis*, en el Golfo San Jose (Chubut, Argentina). *Physis* 92:71-79 (in Spanish).
- Yuanyu, H., Xianfeng, Z., Zhuo, W. and Xiaogiang, W. 1990. A note on the feasibility of using photo-identification techniques to study the Baiji (*Lipotes vexillifer*). Paper SC/A88/P25 (published in this volume).

A Technique for the Photographic Identification and Cataloging of Dorsal Fins of the Bottlenose Dolphin (*Tursiops truncatus*)

R.H. Defran, Gina M. Shultz and David W. Weller

Cetacean Behavior Laboratory, Psychology Department, San Diego State University, San Diego, CA 92182

ABSTRACT

This paper describes a standardised and efficient technique for analyzing and cataloging the dorsal fins of bottlenose dolphins. Dorsal fins are photographed with a 400mm lens mounted on a 35mm camera equipped with a high-speed motor drive. The resulting black and white negatives are sorted into clear duplicates of recognisable dorsal fins, and the best photograph of each individual is traced to uniform size on white paper. A ratio is then computed by dividing the distance between the two largest notches by the distance of the large lower notch to the top of the fin. Tracings are organised by this dorsal ratio within four catalogs: (a) single notches; (b) top notches; (c) two or three notches; (d) four or more notches. Newly traced fins are compared to previous tracings in the appropriate catalog with similar dorsal ratios. In the absence of a resighting, tracings in all catalogs are inspected. Tentative resightings are confirmed by visual inspection of the original negatives with an 8x loupe. A computer program stores, analyses and displays photographic sighting and resighting data.

INTRODUCTION

Caldwell (1955), Irvine and Wells (1972), Würsig and Würsig (1977) and Würsig (1978) were among the first researchers to describe the use of naturally occurring notches in the dorsal fins of bottlenose dolphins to identify individual animals. Since then, a number of investigators have employed these distinctive markings in their assessment of this species' occurrence, movements, behavior and population dynamics (see recent methodological reviews by Scott, Wells, Irvine and Mate, 1990 and Würsig and Jefferson, 1990).

During the last five years, we have carried out extensive boat-based photographic surveys of the Southern California population of bottlenose dolphins. Our need for an efficient and accurate system for cataloging and identifying dorsal fin photographs is directly tied to the large number of individual dolphins which may be encountered and photographed on an individual survey, and the large and growing number of individual dolphins in our catalog. During the last two years of this work we have encountered numerous dolphin schools containing from 40 to >100 individuals. For example, a school of approximately 100 dolphins was encountered recently, resulting in over 675 photographs and the identification of 74 individuals. Thus far, we have analysed approximately 14,000 photographs and have identified over 475 individual dolphins.

Initially, we attempted to implement the dorsal fin identification technique described by Hansen (1983). This slide-based procedure involves the use of a dissecting microscope to divide the dorsal fin into five sections and assigns a code to the fin based on the number of notches in the trailing edge of each section. In our laboratory we found this technique difficult to implement. It was often difficult, for example, to identify the base of the dorsal fin or to reach agreement on the number of notches. Variability in one or both of these judgements was common and diminished the usefulness of the resulting code. Our difficulty in applying the Hansen (1983) technique led us to develop a new method in which initial resightings are based on dorsal fin tracings and distinctive (*vis-a-vis* total) notches.

CAMERAS

The majority of our photographs have been taken with a *Canon A-1* camera equipped with a *Canon* 400mm lens and a high-speed motor drive (5 exposures/sec). Our offshore position (relative to the dolphins) and the early morning hours of our surveys frequently presents us with dorsal fins that are back-illuminated. Under these circumstances we have routinely overexposed our photographs by 1 to 2 f-stops to compensate for the dark fins surrounded by bright water. A second camera, a *Canon AE-1* equipped with a motorised film-winder and a variety of short to intermediate focal length lenses has also been used. The second camera has served as a backup and permitted photographs when the dolphins were too close for long-lens photography.

FILM

Over the course of our work several film types have been employed. Satisfactory identification has been possible with all types but some have had advantages in economy and convenience. Most of our early work was with *Kodachrome* and *Ektachrome* slide film with ASA values between 64 and 400. Under conditions of low illumination, 100 ASA *Ektachrome* was 'pushed' to 400 ASA with satisfactory results. More recently, we have used *Kodak Tri-X* which has an 400 ASA value. While *Tri-X* is a black and white print film, we do our photo-identification work with the developed negatives. There are several advantages to using this film: (1) the 400 ASA value of the film permits fast shutter speeds (1/250 – 1/1000 sec) to be used under most circumstances; (2) the reverse negatives provide good contrast which in turn permits easy tracing (see below) and easier photo-identification; (3) this approach permitted us to reduce the cost of the film and development to about 60% of the cost of color slides. Even greater economy could be achieved by using bulk film.

A final point concerns the potential graininess associated with high ASA films such as *Tri-X*. The close range at which we photograph dolphins combined with the magnification provided by our 400mm lens result in sharp images of dorsal fins which fill a large part of the photographic frame.

INITIAL SORTING AND IDENTIFICATION

The present method begins with a collection of dated negatives from a photographic survey. Clear photographs of distinctive dorsal fins are retained as the 'type' specimen photographs. Subsequent photographs must be clear and sharp enough to match with the 'type' specimen photographs. Negatives taken of a school are then sorted into duplicates of the same dolphin with the best photograph mounted in a slide holder. Each dolphin is then given a temporary identification number and the duplicate negatives are filed by date in the extra slide catalog.

TRACING AND COMPUTATION OF DORSAL RATIO

Dorsal fin slides are rear projected and enlarged to fill a 10cm x 17cm frame drawn on white paper and the contours of the fin are traced. A dorsal ratio is calculated for fins with two or more notches. The top points of the two largest notches are labelled A (top) and B (bottom) (Fig. 1). If notches are similar in size, the two notches farthest from each other are designated A and B. The dorsal fin is then coded as the ratio of the distance between A and B divided by the distance from B to the top of the dorsal fin. As a relative measure the dorsal ratio is unaffected by the size of the fin when photographed, enlarged, or even under moderate cases of parallax. Once calculated, the dorsal ratio is recorded on the tracing.

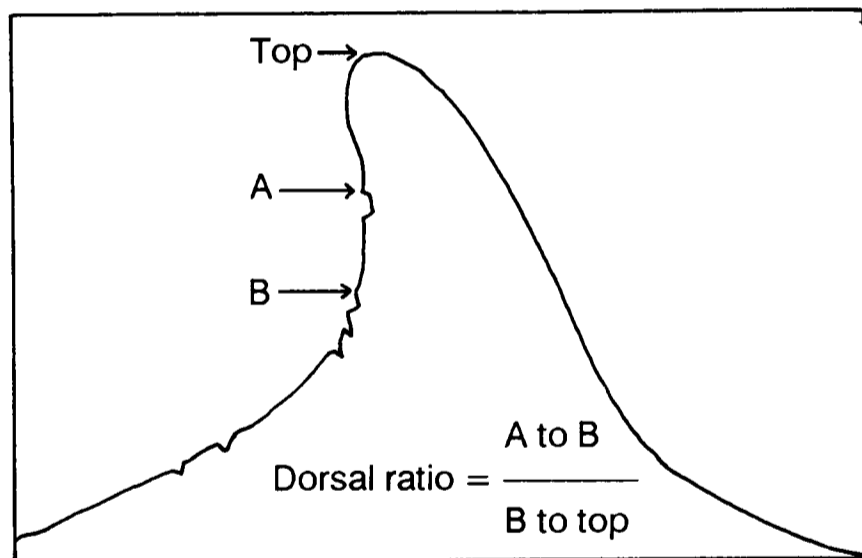

Fig. 1. Dorsal fin tracing and calculation of the dorsal ratio.

SIGHTING AND CATALOGING

All tracings are maintained in one of four tracing catalogs: (A) fins with one distinctive notch and (B) fins with a notch in the top of the fin; (C) fins with two or three notches; (D) fins with four or more notches. Within catalogs A and B, tracings are filed by subject number while tracings within catalogs C and D are filed by dorsal ratio. Once a slide has been traced, it is filed by subject number within the dorsal slide catalog.

When tracing of the fin and calculation of the dorsal ratio are completed, the appropriate catalog is examined for tracings with similar dorsal ratios. If a tracing cannot be matched in the appropriate catalog then all catalogs are inspected twice. Although labour-intensive, this latter procedure is designed to try and ensure that all previously sighted dorsal fins, including those with new notches, will be resighted.

If the tracing is not matched, the dolphin is considered a new sighting and the next available subject number is assigned and recorded on the tracing. When a tracing is matched the current and previous slides are repeatedly compared using an 8x loupe and must also match before a resighting can be confirmed. If no match is made, the fin is given a new subject number. Subject numbers are then recorded on the tracing which is used to update the appropriate tracing catalog.

COMPUTER MAINTENANCE AND ANALYSIS

A computer program was written in DBASE III to record the results of photographic surveys. This program requests keyboard entry of data for either of two data bases: (1) the population data base; and (2) the photographic data base. The entry screen for the population data base requests and accepts data about the date, time and latitude of each school sighted. This same program also requests information about the size of the school, number of calves and the number of new and resighted dolphins. The program for the photographic data base requests and accepts data about photographically identified dolphins including: subject number, dorsal ratio and tracing catalog along with the associated date, time and latitude of the sighting. The program automatically updates each data base and offers options to sort, display and print all or a subset of the data. In its current form the program also offers options for calculating and printing the mean and median group size, calf proportion and a frequency distribution of resighting rate.

DISCUSSION

Our experience with the dorsal fin identification technique we developed has been that it is reliable, simple, efficient and easily learned by laboratory personnel. The dorsal ratio calculation offers a novel way of categorising dorsal fins and shortens the search time required to identify a possible match. It is difficult to quantify the advantage provided by the dorsal ratio. Currently, it is effective in narrowing our search to between 40 to 60 tracings. Predictably, the range of tracings we inspect has expanded with the total number of individuals (having similar ratios) in our catalog. As the size of our catalog approaches 500 individuals we are considering additional dimensions for categorising dorsal fins in order to reduce the number of tracings we inspect for a match. Among the dimensions currently under consideration are the following: (a) Is the largest notch in the top or bottom half of the fin?; (b) Are the majority of notches in the top or bottom half of the fin? We anticipate that the integration of one or both of these criteria with those already described will considerably shorten the time required to identify possible matches. There is a consensus among those of us who have applied the technique that the dorsal ratio itself is only one of several features which make it work. Perhaps the most salient feature of the technique is that initial resighting work is based on uniform tracings rather than slides. The process of inspecting a large number of fins is considerably easier with tracings than slides (c.f. Bannister, 1990). However, once tracings have been used to isolate possible matches, the final decision is based on visual inspection of the original negatives.

Identifying new sightings, which frequently requires inspection of all tracings is the most time consuming task. The payoff for caution in declaring a new sighting, however, is that we avoid artificial inflation of the catalog.

ACKNOWLEDGEMENTS

The authors wish to express their appreciation to Charlene Walsh, Leslie A. Tipton and Miriam A. Espinosa for their contributions to the development of this technique and for their early work in its application. We would also like to acknowledge Aaron Weinfield who wrote the DBASE III program.

We also extend our appreciation to Bernd Würsig, Moss Landing Marine Laboratories, P.O. Box 450, Moss Landing, CA 95039, Michael D. Scott, Inter-American Tropical Tuna Commission, c/o Scripps Institution of Oceanography, La Jolla, CA 92093 and an anonymous IWC referee who provided peer review of this manuscript.

REFERENCES

- Bannister, J. 1990. Southern right whales off western Australia. Paper SC/A88/ID17 (published in this volume).
- Caldwell, D.K. 1955. Evidence of home range of an Atlantic bottlenose dolphin. *J. Mammal.* 36: 304-5.
- Hansen, L.J. 1983. Population biology of the coastal bottlenose dolphin (*T. truncatus*) of Southern California. M.A. thesis, Sacramento State University, Sacramento. 104pp.
- Irvine, A.B. and Wells, R.S. 1972. Results of attempts to tag Atlantic bottlenose dolphins, *Tursiops truncatus*. *Cetology* 13:1-5.
- Scott, M.D., Wells, R.S., Irvine, A.B. and Mate, B.R. 1990. Tagging and marking studies on small cetaceans. pp.489-514. In: S. Leatherwood and R.R. Reeves, (eds.) *The Bottlenose Dolphin*. Academic Press, San Diego.
- Wells, R.S., Scott, M.D. and Irvine, A.B. 1987. The social structure of free-ranging bottlenose dolphins. pp.247-305 In: H. Genoways, (ed) *Current Mammalogy* Vol. 1. Plenum Press, New York. 519pp.
- Würsig, B. 1978. Occurrence and group organisation of Atlantic bottlenose porpoises (*Tursiops truncatus*) in an Argentine bay. *Biol. Bull.* 154:348-59.
- Würsig, B. and Jefferson, T.A. 1990. Methods of photo-identification for small cetaceans. Paper SC/A88/ID13 (published in this volume).
- Würsig, B. and Würsig, M. 1977. The photographic determination of group size, composition, and stability of coastal porpoises (*Tursiops truncatus*). *Science* 198:755-6.

Computer Aided Matching of Natural Markings: A Prototype System for Grey Seals

Lex Hiby

*Sea Mammal Research Unit, c/o British Antarctic Survey, High Cross,
Madingley Road, Cambridge CB3 0ET, UK*

and

Phil Lovell

Conservation Research Group, PO Box 114, Cambridge CB4 1YJ, UK

ABSTRACT

This paper describes a technique for automated screening of a library of natural marking photographs. The system was designed to match pelage patterns on the head and neck of grey seals, but can be adapted for other species in which at least some individuals carry distinctive patterns. The main feature of the technique is the use of a three-dimensional model to locate a particular region of the body surface and to describe the pattern within that region in such a way that the resulting description is not seriously affected by the orientation and posture of the animal at the moment the photograph was taken. Given a new photograph, the library is screened to identify all potential matches, which are then compared by eye to the new photograph. The number of photographs which need to be compared by eye is thus drastically reduced, allowing natural marking techniques to be applied to larger populations.

INTRODUCTION

As the number of animals identified in natural marking studies increases, the need for a system to aid the visual identification process becomes more and more important. Handling large numbers of photographs and searching for matches between photographs is time consuming, expensive, and is likely to lead to errors (Katona and Beard, 1990). This paper describes a system developed to reduce the time taken to match a new photograph with a catalogue of existing photographs. The paper concerns automation of the matching process, not the merits of natural marking as a technique for population study nor the suitability of any particular type of marking. Thus, although we believe that pelage markings of female grey seals are distinctive and constant over time, we present no data here to support this. Yochem, Stewart, Mina, Zorin, Sadovov and Yablokov (1990) consider the stability and distinctiveness of pelage patterns in harbor seals.

The system described here is based on a desktop microcomputer which makes it suitable for use in the field and for wildlife management in developing countries. Whitehead (1990) describes a microcomputer-based system for sperm whales.

LOCATING THE PATTERN CELL

Automated matching of natural markings involves deriving numerical descriptions of those markings and calculating similarity scores between the numbers. In some species, markings include features which, although differing in detail between individuals, are broadly consistent in shape and location. One example is the harp-shaped feature present on the dorsal surface of most adult harp seals, another is the outline of a dorsal fin or tail fluke. In such cases it is natural to use a numerical description of those features. However, many species (including grey seals) have no such features and the region to which the description applies (subsequently called the 'pattern cell')

cannot be located with reference to markings themselves. In such cases the pattern cell must be located in relation to morphological features (eyes, ears, etc.). However, positioning the cell will be prone to error if the area of the body which is normally distinctively patterned is remote from the nearest morphological features. In photographs of grey seals, the side of the neck is often visible and in females is usually boldly patterned. We decided to site the pattern cell in this area, defining its position in relation to the eye and ear. However, the surface of the neck is non-planar, so that the appearance of the pattern changes with viewpoint and is subject to changes in shape as the posture of the seal varies. To overcome these difficulties we constructed a mathematical model of the surface of the head and neck to help in locating the cell and extracting the numerical description from it (Fig. 1).

Each new photograph is digitised using a video digitiser and displayed on the computer screen. The model is then projected on to the image, transformed and distorted to fit the outline (Figs 2 and 3). The pattern cell is defined as a subset of the three-dimensional coordinates which make up the model; hence these also project to a set of points on the screen. The numerical description consists of the grey-scale intensities which are read from the image at these points and stored as a matrix of numbers (subsequently called the 'identifier array' or 'IA', Fig. 4). Because the model of the surface is fitted to each new photograph, the numerical description obtained in this way is invariant to viewpoint and posture changes; the same IA will be obtained from different photographs of the same seal. This procedure is, of course, conducted only once for each new photograph – subsequent comparisons are simply between IAs and are totally automatic.

Construction of the model

The above mathematical representation is obtained by interpolation and contouring over a set of three-dimensional coordinates scattered over the head and

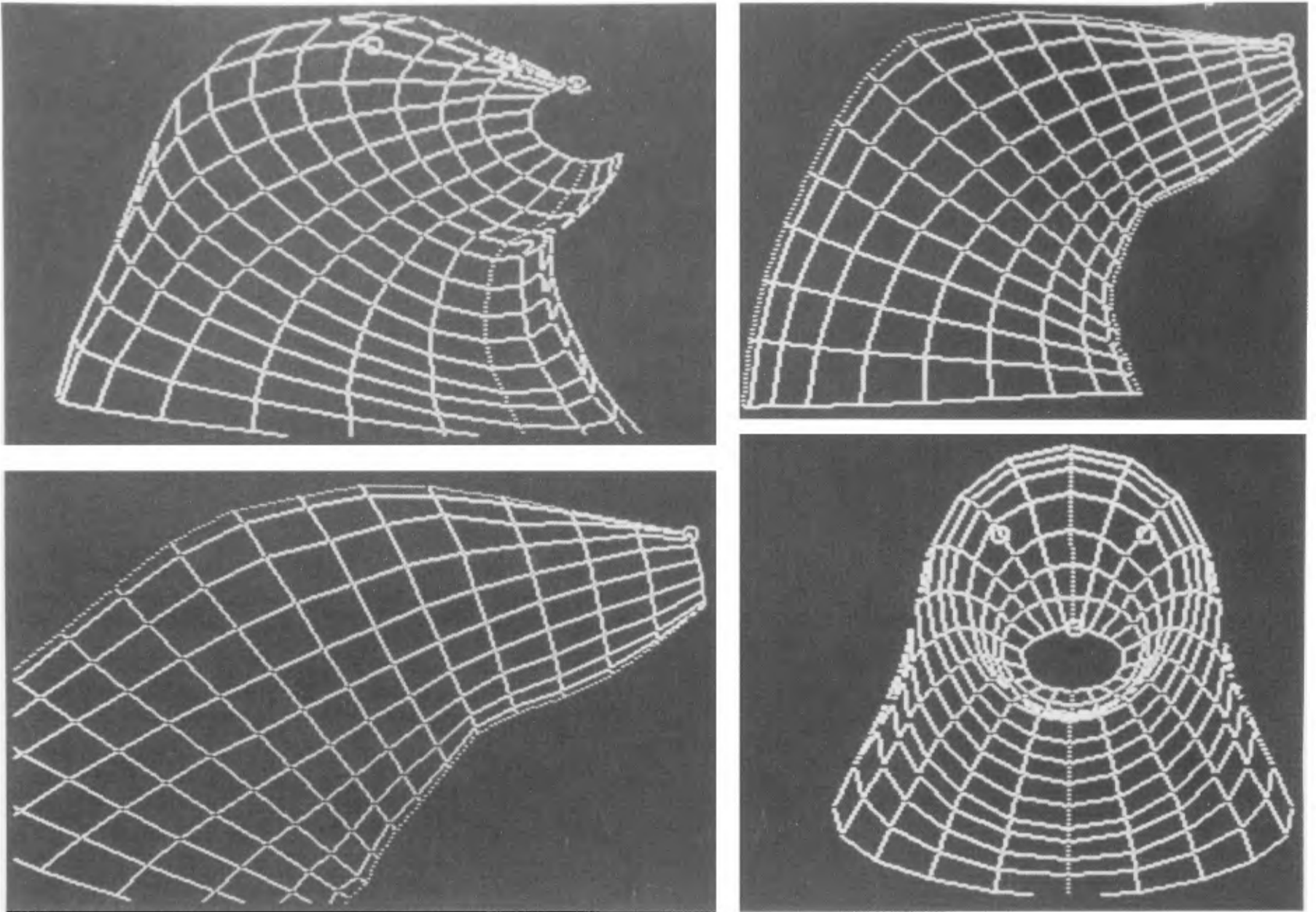

Fig. 1. Projection of surface model from different viewpoints and in different postures.



Fig. 2. Digitised photograph of adult female grey seal.

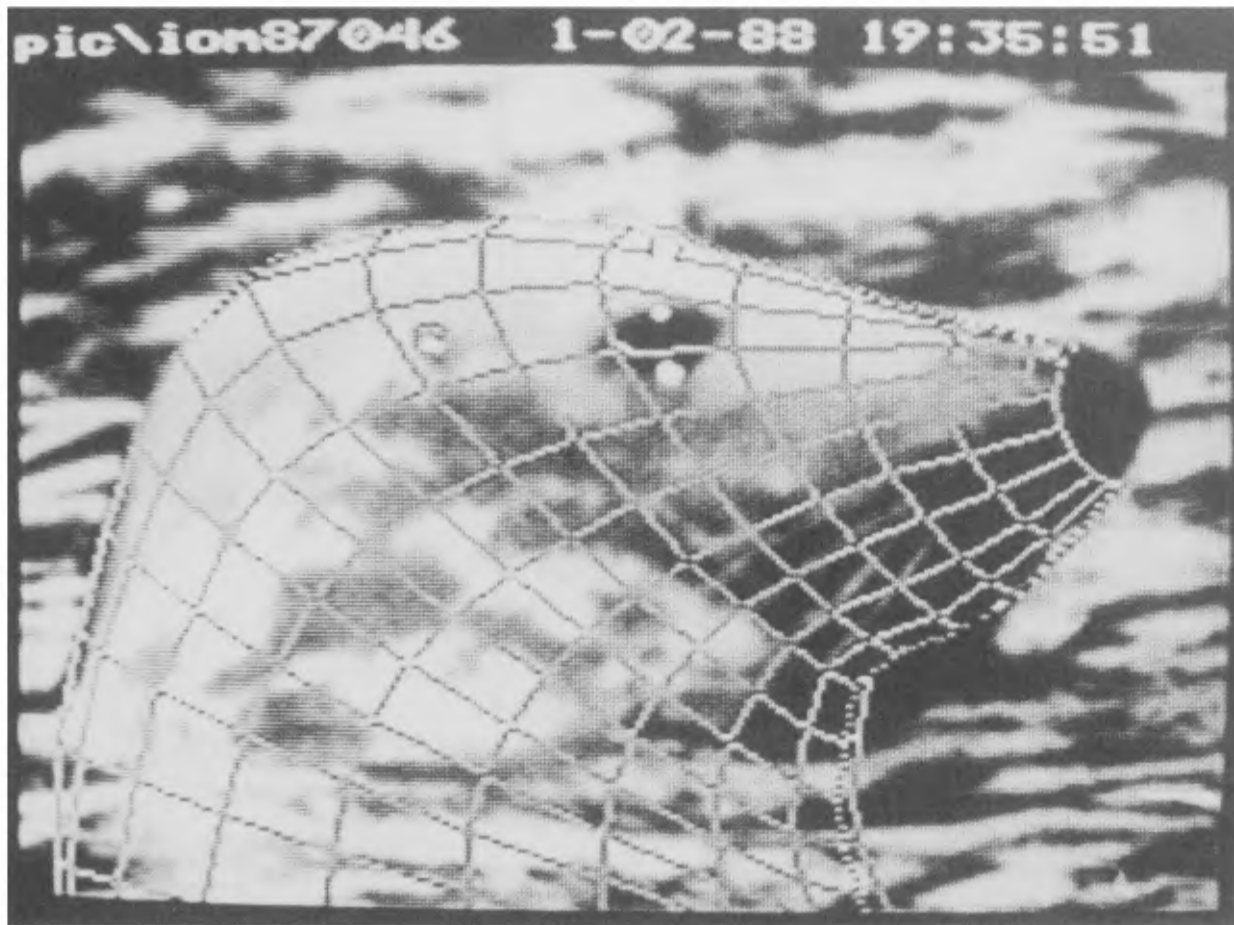

Fig. 3. Surface model fitted to digitised photograph.

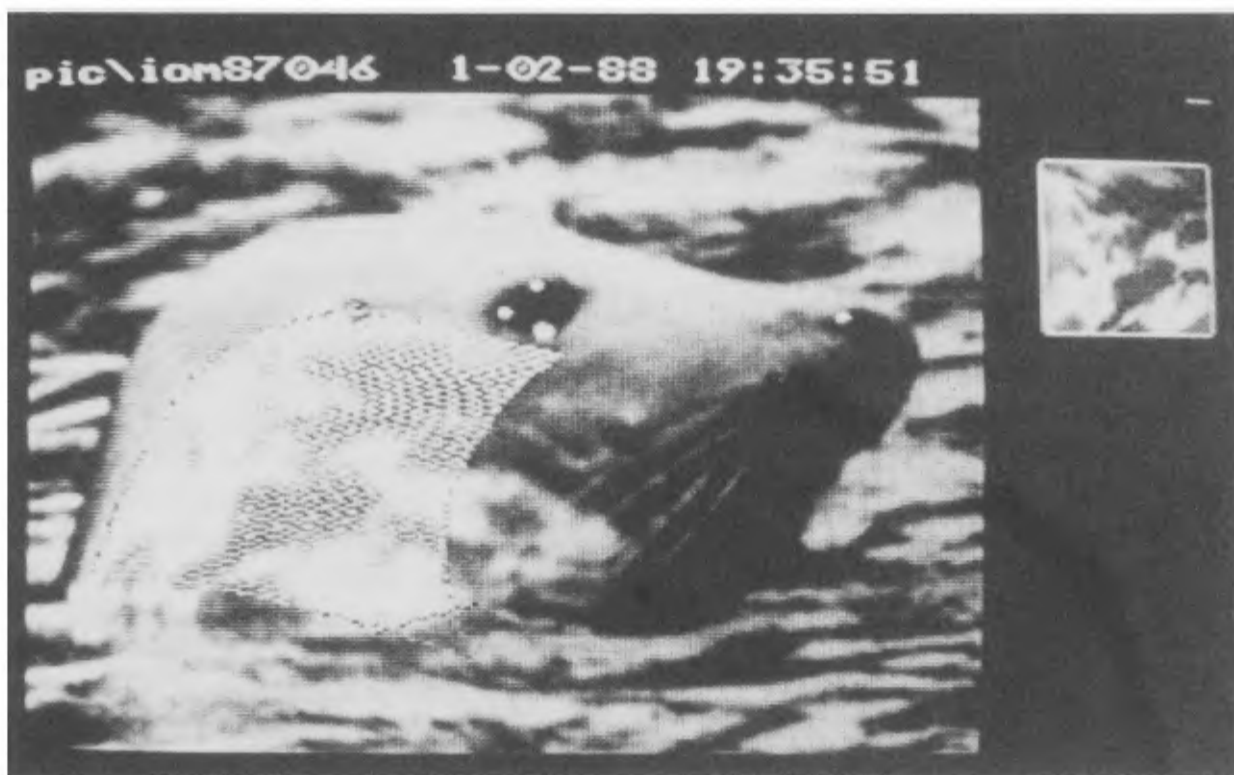

Fig. 4. Position of pattern cell and resulting identifier array (displayed to the right of the main photograph).

neck. These original coordinate positions were identified by recognising corresponding points on stereo photograph pairs of a captive seal and subjecting these to standard photogrammetric analysis. Because seals are highly mobile, a rigid ring of six cameras was required to obtain, simultaneously, sufficient sets of stereo pairs. For an animal which is well-patterned on a rigid region of the body, constructing the model should be much simpler as only one set will be required and photographs can be obtained by using a single camera and walking around the animal.

Fitting the model

In the current prototype system, the fitting of the model to each new photograph takes a few minutes. The operator is guided through the procedure by an interactive

menu-driven program. The first task is to use a cursor to identify on the screen the position of three features (eyes, ears, nostrils etc.) which have known coordinates in the surface model. The program calculates the translations and rotations of the model required to cause the two-dimensional projection of these points to coincide with the identified positions. The operator can then perform a number of shape changes to the surface model, such as extending the neck or twisting the head to left and right to match the outline of its projection to the outline of the seal in the photograph. Such changes in shape of the surface model cause adjustments in the pelage cell coordinates which are intended to mimic movements of the skin which accompany changes in posture. The adjustments required were calculated by constructing a number of surface models using sets of stereo photographs of the same seal in

different postures and interpolating among them. Having obtained a satisfactory fit, the operator initiates reading of the IA from the screen. However, before the program reads the grey scale intensities, it displays the borders of the pattern cell to allow the operator to check that no part of it is under water or obscured by highlights. Partially obscured cells are not suitable for inclusion in the library.

COMPARING THE IDENTIFIER ARRAYS

Currently, similarity between different identifier arrays is defined as the correlation coefficient between corresponding array elements. This measure has the advantage of invariance to average brightness and contrast of the digitised photograph. The correlation is calculated for a number of subregions and the average taken to reduce the influence of any gradual change in intensity across the image. However, the procedure described for extraction of the pattern cell is not sufficiently accurate to allow the use of only one evaluation of the correlation between two arrays. Alignment errors cause stretch and shear discrepancies between pattern cells extracted from different photographs of the same seal, particularly at the lower ends of the cells. That is, the lower edge of one cell may be displaced horizontally and vertically from the lower edge of the other. The similarity score used is thus the maximum correlation achieved by stretching and shearing one array over the other. One array is designated as 'stationary' and the other as 'moving'. To stretch the moving array its base is moved up or down; to shear the array its base is moved to the left or right. Each element in the moving array thus attains a new position relative to the stationary array and is compared to the four elements in the stationary array lying nearest to that position. Because the perturbations applied to the moving array are not purely translations, as in conventional template matching (Rosenfeld and Kak, 1976), we have been unable to apply fast Fourier transform techniques to evaluate the correlations. With the 48 x 48 array size used currently, the search for the maximum correlation between each pair of arrays takes about 2s on a 16 bit desktop microcomputer (thus, for example, over 5 hours to search a library of 10,000 IAs). A priority for further development of the method is to reduce this time considerably without resorting to more expensive hardware.

RESULTS USING A TEST LIBRARY OF SEAL PHOTOGRAPHS

Adult grey seals disturbed at breeding or haul-out beaches enter the water and observe the beach from a short distance offshore. Photographs of the head and neck region can be readily obtained from the beach at this time using a hand-held camera and telephoto lens. A set of 58 such photographs of 21 females was used to test the method. The photographs were taken under a variety of lighting conditions and exhibit a range of viewpoint and posture combinations – all photographs showing most of the head clear of the water and the position of the ear were included in the test.

Each photograph was digitised, the pattern cell located, and the IA read off and stored in one of two libraries, depending on whether the left or right ear was visible. The similarity measures calculated between all pairs of IAs in the same library are shown in Fig. 5 as two frequency histograms, one for photographs of different seals and the other for photographs of the same seal.

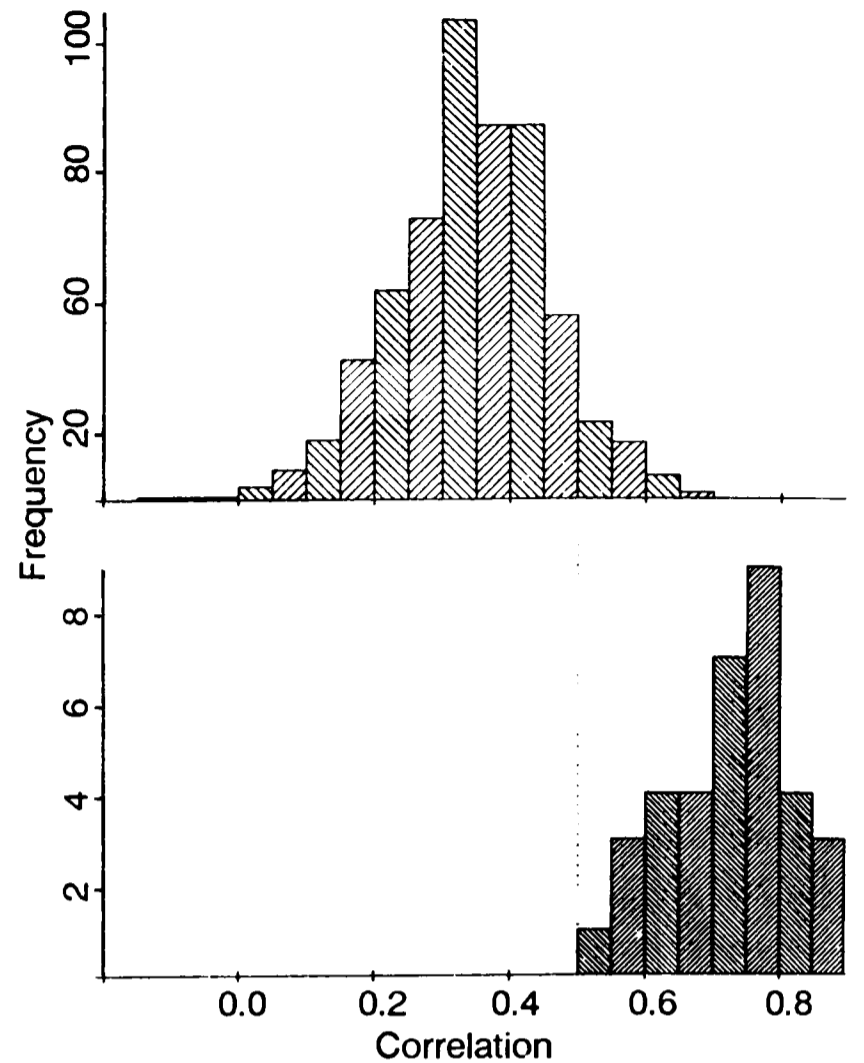

Fig. 5. Frequency histograms for similarity scores between photographs of different seals (upper histogram) and the same seal (lower histogram).

However, for some pairs of IAs (none of which were from the same seal) the search for the maximum correlation led to unacceptably large values of stretch or shear. At this point the search was terminated and so these pairs do not contribute to the histogram. The lowest similarity between any pair of IAs from the same seal was more than 0.5; 98% of IA pairs from different seals produced similarity scores less than 0.5. Thus, in searching the library for potential matches with a given photograph, 0.5 could be accepted as a threshold similarity level. That is, photographs corresponding to any IAs having a similarity to the IA of the given photograph of more than 0.5 would be presented as potential matches. In that case, with the current procedure, we could expect about 2% of the library photos to be presented and hence require comparison by eye with the given photo.

The test library comprised all photographs of which the ear was visible – low quality photographs (out of focus, affected by glare, etc.) were not excluded. For future application of the technique it will be necessary to develop criteria by which unsuitable photographs can be rejected. The number of photographs in the test library is currently too small to permit the development of such criteria. However, it is clear that photographs of partially-wet pelage will not be acceptable.

CONCLUSIONS

The results presented in Fig. 5 suggest that computer matching is a practical procedure which should allow the use of natural markings for studying populations considerably larger than those currently monitored using natural markings. Further development of the method for grey seals and other populations should reduce the time

taken to search the IA library and increase the mean difference between similarity scores for photographs from the same and different animals.

ACKNOWLEDGEMENTS

We thank Simon Cousens of the London School of Hygiene and Tropical Medicine for his contribution to the development of this technique, and Joe Horwood and Justin Cooke for their valuable comments on the manuscript. We would also like to thank the International Fund for Animal Welfare for their financial support.

REFERENCE

- Katona, S. K. and Beard, J. A. 1990. Population size, migrations, and feeding aggregations of the humpback whale, *Megaptera novaeangliae*, in the western North Atlantic Ocean. Paper SC/A88/ID2 (published in this volume).
- Rosenfeld, A. and Kak, A. C. 1976. Digital Picture Processing. *Academic Press*. 457pp.
- Whitehead, H. 1990. Fast computer-assisted individual identification of sperm whale flukes. Paper SC/A88/ID42 (published in this volume).
- Yochem, P. K., Stewart, B. S., Mina, M., Zorin, A., Sadovov, V. and Yablokov, A. 1990. Non-metrical analyses of pelage patterns and photographic identification of individuals in demographic studies of harbor seals. Paper SC/A88/P24 (published in this volume).

Computer Assisted Photo-Identification of Humpback Whales

Sally A. Mizroch¹, Judith A. Beard² and Macgill Lynde³

ABSTRACT

This paper describes a computerization data base/video disc system that aids in identifying resightings of individual humpback whales based on photographs of their tail flukes. The system is based on one developed by Balcomb and Katona in the late 1970s, but has new matching criteria, IBM-PC compatibility and uses data base management software to improve query and retrieval capabilities. New algorithms have been developed to rank and sort potential matches based on the user's description.

Flukes are coded manually based on pigment pattern, the shape of the notch between the flukes and location of marks and scars on the fluke. To search for matches to a new photograph, the user chooses the most appropriate pigment pattern and notch shape and indicates the location of any marks and scars. The computerized system then uses a weighted matching algorithm to rank each photograph in the data base in relation to the new photograph, and automatically displays possible matching photographs on the video screen in order of match probability. The matching algorithm has been designed to account for variations in photographic quality and reader subjectivity.

The system has been developed for matching humpback whale flukes, but has general application for any photo-identification study where the identifying characteristics can be easily categorized.

INTRODUCTION

About 20 years ago, researchers discovered that there was enough variation in natural markings of humpback whale (*Megaptera novaeangliae*) flukes that individuals could be photographed, identified and tracked over time (see Katona and Beard, 1990 and Perry, Baker and Herman, 1990, for useful summaries of the development of the technique). Researchers conducting long-term studies using photo-identification techniques have been able to determine distribution and migration of whales by photographing whales in feeding areas and breeding grounds, determine calving rate by photographing female whales with and without calves in different years and document age at sexual maturity by photographing known age females with calves that had first been photographed themselves as calves.

As photographic collections grew, so did the need for faster techniques to compare new photographs to those previously catalogued. For example, the College of the Atlantic curates the North Atlantic humpback whale catalog, currently containing over 9,000 photographs representing 3,647 individual humpback whales. The National Marine Mammal Laboratory curates the North Pacific collection, the synthesis of a number of separate research catalogs into a single collection of over 9,000 photographs. This paper describes a method developed for using computers to assist in the matching process.

Fundamental to this task is the need to 'tell' the computer which identification features of a fluke are important. There are various ways of describing photographs to a computer. For example, the photographic image could be digitized, brought directly into the computer's memory, scaled and rotated to some standardized plane, if needed, and enhanced. A rendition of the digitized image could then be stored for later retrieval and comparison. Hiby and Lovell (1990) describe such a system developed for grey seals.

Alternatively, one can categorize photographs by eye rather than digitally. Early efforts to create this type of system were developed in the late 1970s by Steve Katona, Ken Balcomb and colleagues at the College of the Atlantic, but their efforts were limited by technological constraints.

The system described here is an extension of that system and was developed as a collaborative effort by the National Marine Mammal Laboratory (NMML) and humpback whale researchers working in the North Pacific and North Atlantic Oceans (Frady, 1987). It uses commercial data base software to store data about each photograph and is IBM-PC compatible. As in the previous system, photographic images are stored on a video disc which can contain up to 54,000 single frame images. However, coding protocol, data storage, retrieval and analysis and system response have been improved.

METHODS

Data entry is fast (see Fig. 1 for an example of the data entry screen), averaging less than two minutes per photograph entered, and hardware needs are minimal, involving an IBM-PC compatible computer, a laser video disc player and a TV monitor.

NUMBER: Accession		NMML ID:		Video disc:			
CONTRIBUTOR: First name:		Affiliation:		Contributor codes:		Contributor comments:	
Last name:		Archive location:		Photo date:			
LOCATION: Area:		Latitude: deg. min.		Sub-area:		Longitude: deg. min.	
PHOTO DATA: Photo quality:		Pattern:		Recognition quality:			
				Location of marks:			
WHALE DATA: Age class:		Group size:		Sex:		Group ID:	
						# calves:	
COMMENTS:							

Fig. 1. Example of a data entry screen

¹ National Marine Mammal Laboratory, Seattle, WA, USA.

² College of the Atlantic, Bar Harbor, MA, USA.

³ OceanTech, Inc., Seattle, WA, USA.

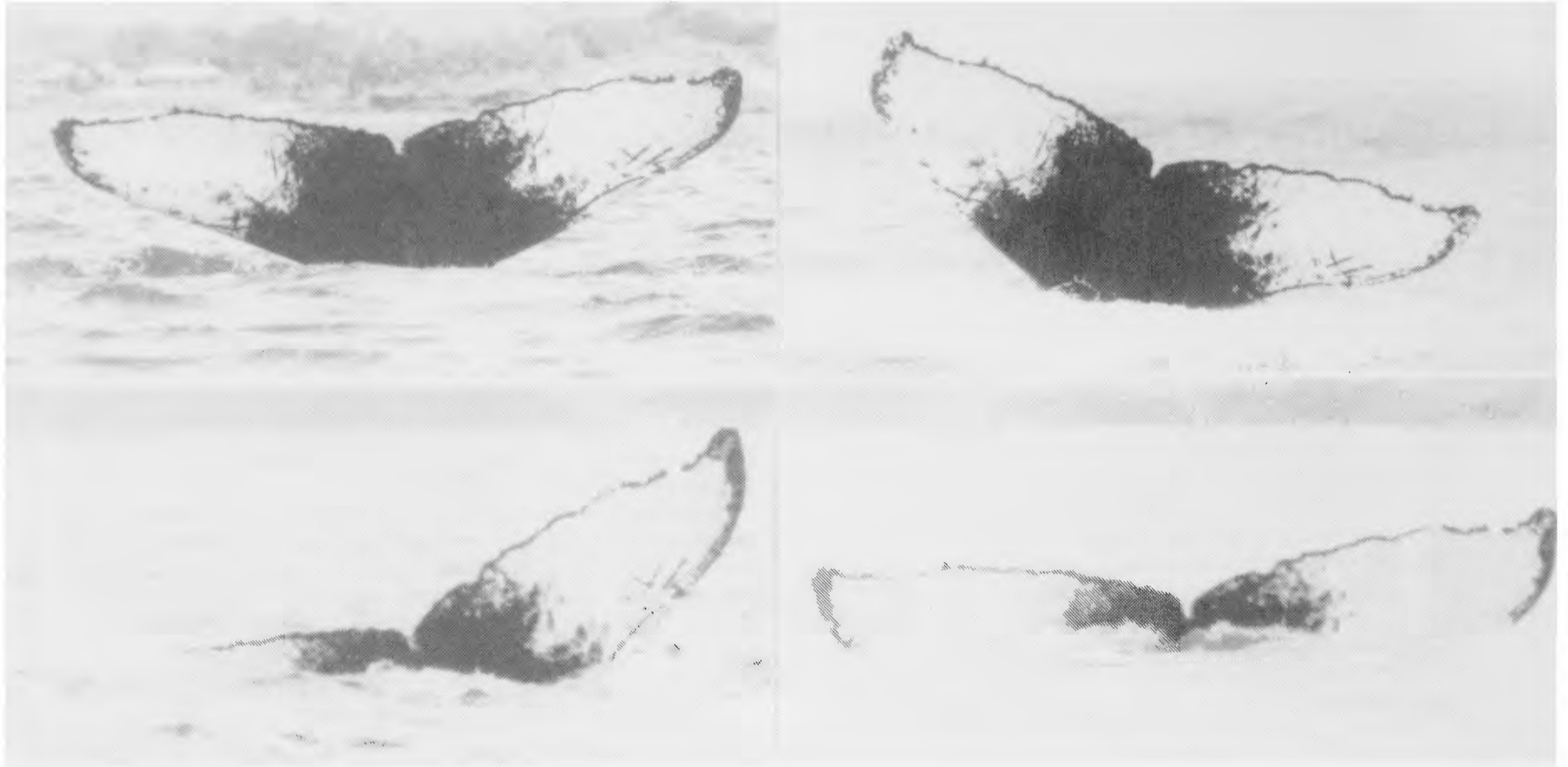

Fig. 2. Four different photographs of the same animal taken at different angles. Photographs courtesy of Kewalo Basin Marine Mammal Laboratory, University of Hawaii.

Simple, easily learned categorical descriptions of the photographs are stored in the data base. If the photograph is badly rotated (see Fig. 2), the image is 'standardized' by eye. The system can rank photographs based on similarity to the new photograph and presents the ranked images on a video screen in fractions of seconds.

Software and hardware needs

Software

The system uses *Rbase for DOS* for data storage and retrieval and the matching software is written entirely in the *Rbase* programming language. Users can either buy the full *Rbase* product, and have full access to a large suite of data base functions, or can use a 'Match only' version of the system provided by the authors.

Computer

Although the system will run on any *IBM-PC* compatible, DOS 3.0 and above, it is recommended that the computer have at least a 80286 processor (but faster if the budget allows), at least 512K RAM, a serial port and a fast hard drive. The data base currently takes about 6 Mbytes of space on the hard drive, plus another 4 Mbytes to include the full *Rbase* data base software or 0.3 Mbytes to hold a 'Match only' version of the matching software described here.

Video disc player

Several video disc players have been used with this system, and the minimum requirement is that the disc player has a serial port in order to accept commands from the computer. To date, communication protocols have been established with the *Pioneer* LDV-6000, *Pioneer* LDV-4200 and *Sony* LDP-1000A.

Television monitor

Any television monitor that can accept NTSC input from a peripheral, such as a VCR or video disc player, can be used.

Categorizing photographs

Photograph descriptions are based on three criteria: pigment pattern, location of natural marks and scars and the shape of the notch between the flukes.

Pigment pattern

Thirty-eight stylised, generic pattern codes were developed to symbolize the many variations which occur on humpback flukes (Fig. 3). Pattern features include the presence of black or white on the leading or trailing edges; characteristics of the medial line (broken, solid or absent); and the amount of black pigmentation within the fluke. Except for patterns 50–64, the 'miscellaneous' set, the generic patterns are not expected to mimic the specific pattern exactly. The miscellaneous set was developed based on known, unusual pattern types.

If the pattern is asymmetric, i.e., the right side of the fluke fits one pattern and the left side fits another, the fluke is coded based on the pattern on the right side and ASYM is typed into mark sector 1 (see next section).

Marks

Significant natural markings and scars are located within the 14-sector fluke map originally developed by Balcomb and Katona (Fig. 4, Table 1). If marks extend across sectors, the appropriate code is placed in each applicable sector. Mark codes refer simply to the presence, not frequency, of a particular type of mark, and uppercase letters refer to a black mark, lowercase to a white mark. For example, a sector containing four black circles would be coded with a single C. Presence of more than one type of scar in a sector is recorded as a character string in alphabetical order, e.g. Cs for a black circle and a white spot.

Notch shape

Fluke notches can be rounded, squareish or a narrow or wide v-shape. A description of the shape of the notch is coded into mark sector 2 along with any other mark codes (see Fig. 4).

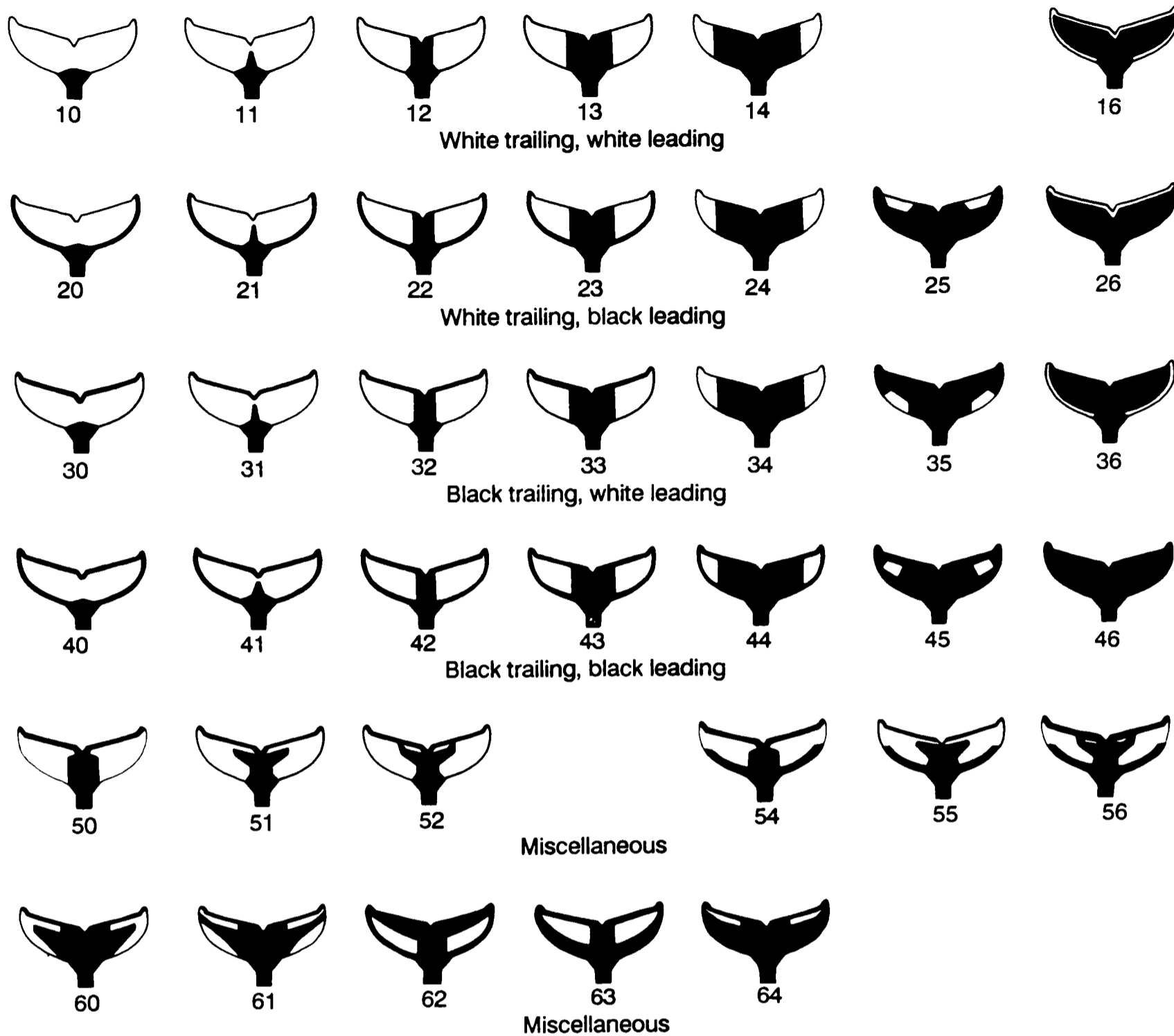

Fig. 3. Generic fluke patterns.

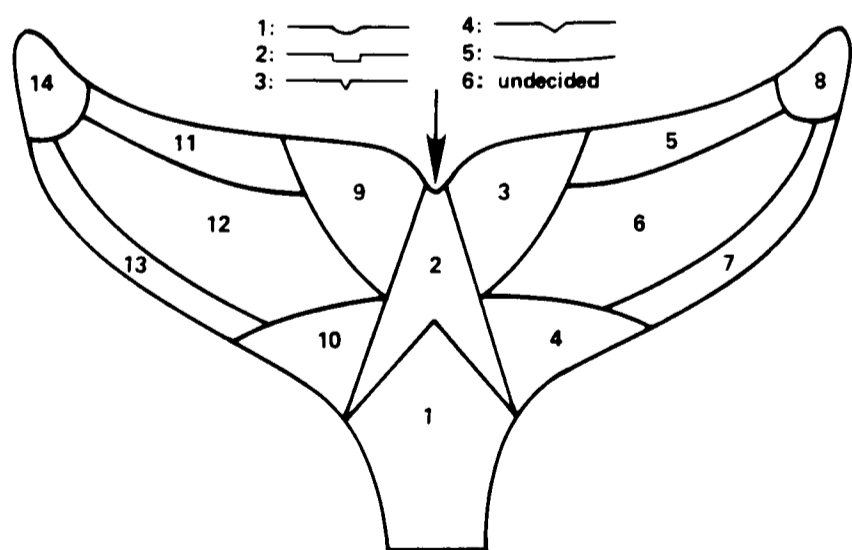

Fig. 4. Fluke map. See Table 1 for mark codes.

Matching photographs

Once the photographic descriptions are stored in the data base, there are two ways to look for a match, MATCH and SCAN.

MATCH

The MATCH routine compares the pattern, mark code and notch shape characteristics of the unknown whale to the entire data base and uses an algorithm to rank whales with similar patterns and marks together.

Table 1

Description of mark codes. Upper case is used for black marks and lower case for white marks.

Can't tell	*	Sector underwater, out of frame, or at bad angle
Circles	C,c	Open circular marks, either black with a white center or white with a black center
Flecks	F	Mottled pigmentation, not appearing to be produced by scars or injury
Hole	H	Hole
Lines	L,l	Any linear mark (straight, curved, etc.) whose length is at least 4 times its width
Missing	M	Sector missing from animal
Notch	N	Notch, nick or bite
Rakes	R,r	Parallel linear marks, appearing to be caused by predator bites
Spots	S,s	Closed circular, non-linear marks
Distinctive	X	Distinctive mark of any kind (A mark which in itself might help identify the animal. Used in conjunction with any other mark code, i.e., large black lines in the shape of a 'V' would be coded "XL".)

This routine was designed to minimize errors due to difficulties in interpreting photographs. For example, due to differences in lighting or angle, a fluke of a particular whale may appear to have a black leading edge in one photograph and a white one in another, e.g. it might look like pattern 33 in one photograph and pattern 43 in another (see Fig. 3). As another example, subtle white marks may be difficult to see on the leading edge of a fluke, and hence patterns 45 and 66 could be confused (Fig. 3).

The matching routine uses a fluke pattern similarity matrix that represents the probability that a photograph will be 'misclassified'. For example, patterns 10 and 11 are very similar, while patterns 10 and 46 are exact opposites.

Photographs coded with the same pattern as the new whale are given an initial rank of 20. Photographs with a pattern similar to the new whale (based on values in the similarity matrix) get a lower rank, ranging from 15 to 19 and photographs entirely dissimilar to the new whale receive no rank based on pattern.

After the photographs are ranked based on pattern, the mark sectors are examined and each time a mark sector corresponds exactly, 1 is added to the rank. Since there are 14 sectors and the highest pattern ranking is 20, the highest overall rank possible is 34. A whale with all 14 sectors matching, but with an entirely dissimilar pattern, would receive a rank of 14.

In current use with the North Pacific data base, using a 20Mhz 80386 computer and scanning about 9,300 photographs, the MATCH routine takes about 10 minutes to rank the data base. When the ranking is completed, the system displays photographs one at a time, in order of

highest rank to lowest, and the photographs are evaluated by eye, comparing the new photograph in hand to those displayed one by one on the TV monitor. In many cases, the video image is good enough to verify a match. However, if the video image is not clear enough, the original photograph is pulled from the file for checking against the new photograph. If there is any doubt about the match, other photographs of the same animal are pulled for comparison, if available. If there is still any doubt about the match, it is not considered a match. There are no 'probable' matches.

SCAN

The SCAN routine does a quick data base scan based on criteria selected by the user. For example, Fig. 5 shows how to bring up all the flukes with a broken medial line, black trailing edge and white or black leading edge (PATTERN EQ 31 OR PATTERN EQ 41) that have missing parts of sector 8 (MARK8 CONTAINS M) and a distinctive black line in sector 12 (MARK12 CONTAINS XL). The SCAN routine is used to look for unknowns with distinctive patterns or distinctive marks and scars and executes usually within 40–60 seconds. Due to the slow execution time of MATCH and the speed of SCAN, an experienced user will be able to mimic the similarity matrix and search out matches even if other photographs have been classified using a different pattern.

Other data fields

Additional information stored for each photograph includes the following (Table 2):

Table 2
Variables on the Photo-ID entry/edit screen

Variable name	Column name	Description
NUMBER		
Accession #	ACCESS	Unique # assigned by NMML to each photo
NMML ID	#NMMLID	ID# assigned by NMML, unique to each whale
Video Disc #	VIDNUM	Frame number giving location of photograph on the videodisc
CONTRIBUTOR		
First name	PHOTOGFN	First name of photographer
Last name	PHOTOGLN	Last name of photographer
Affiliation	PHOTOAFF	Research group of photographer
Archive location	ARCHIVE?	[reference for NMML purposes]
Photo date	PHOTDATE	month/day/year, e.g., 2/3/83
Contributor code	CONCODE1 CONCODE2	2-part text (alphanumeric) field for contributor's whale codes
Comments	CONCOMM	For comments written in photo margins or on slide mounts
AREA		
Area	AREA	In the North Pacific, areas such as Alaska, Mexico, Hawaii
Sub-area	SUB-AREA	In the North Pacific, sub-areas such as Farallon Islands, Maui
Latitude	LATD, LATM	Latitude degrees and minutes
Longitude	LONGD, LONGM	Longitude degrees and minutes
PHOTO DATA		
Photo quality	PHOTQUAL	Quality of photograph (codes 1-3)
Distinctiveness	RESIGHTQ	Quality of pattern (codes 1-3)
Pattern	PATTERN	See Fig. 3
Location of marks	MARK1-MARK14	See Fig. 4
WHALE DATA		
Age class	AGECLASS	Adult juvenile, or number if known age
Sex	SEX	Sex, with method of determination (see Table 4)
Mother/calf info	MOMCALF	Presence or ID of associated mother or calf
Group size	GRP-SIZE	Number of individuals in a group
Group ID	GRP-ID	Unique group-ID number to link whales in a group
Comments	COMMENTS	General comments

Photograph quality (PQ), is related specifically to the photographic image: focus, glare, angle, distance and the amount of fluke surface visible. *Recognition quality* (RQ), is a measure of the presence of distinctive scars or pigmentation that would improve one's ability to re-identify the animal if photographed again. Each quality field is scored excellent (1), moderate (2) or poor (3).

It is important to separate these two types of quality codes in order to quantify the proportion of usable photographs versus proportion of re-identifiable whales.

A full fluke photograph, well lit and in focus, with clearly defined pigmentation and marks, trailing edge or other distinctive characteristics would have a photograph quality and recognition quality both coded as 1. A clear photograph showing only a portion of a fluke but containing distinctive pigmentation would have a low photograph quality (either 2 or 3), but a higher recognition quality (1 or 2). An excellent photograph of an animal with an all black fluke with no scars could have a high photograph quality (1) but a low recognition quality (3). A distant or out-of-focus fluke revealing little detail would have both low photograph and low recognition quality (3 and 3).

Filing numbers

Several data base fields (or variables) are used for keeping track of photographs in the system. The photographs are filed by a unique *Accession number* assigned to each photograph when received. A unique ID number (*NMMLID #* or *North Atlantic ID*) is assigned to each individually identified animal. The actual frame location of the photographic image on the video disc is also stored in the data base (*Video disc #*).

Contributor information

Contributor information recorded includes *First name*, *Last name*, *Affiliation*, *Date of photo*, as well as *Contributor code*, a two-part field used to record any identifying codes that the contributor assigns to each photograph, such as roll and frame, or ID, or field numbers. A 35-character *Comments* field is also provided for encoding any information written by contributors on the margins of photographs or on edges of slide mounts.

Location

Location information includes geographic *Area* and *Sub-area*, and *Latitude* and *Longitude*, if available. Table 3 has some examples from the North Pacific.

Other data

The last few fields are for data such as *Age class*, *Sex* (Table 4), *Mother/calf associations*, *Group size*, and *Group identification number* (a unique number used to link whales that have been seen together). General comments can be placed in the 65-character *Comments* field.

RESULTS

The system was developed and tested using the North Pacific humpback whale collection curated at the NMML. This collection contains at present 9,353 photographs, of which 9,051 are fully coded flukes. The remaining photographs in the system are either flukes yet to be coded, dorsal fins or other body parts. The photographs in the collection were contributed by 22 research groups or individuals working in all areas of the North Pacific. Photographs are sent to the NMML each season in batches ranging from 50 to 2,000 photographs. Unique accession

Table 3.
North Pacific humpback whale areas and sub-areas

Area	Sub-area
Mexico	West Coast Banderas Bay Baja California Revillagigedo Archipelago Gulf of California Tres Marias/Isabel Island South Mainland Coast
California	North, beginning at Cape Mendocino Central South, beginning at Point Conception
Oregon	
Washington	
British Columbia	North Mainland inlets South Mainland inlets Queen Charlotte Islands Offshore banks
Southeast Alaska	Glacier Bay Sumner Strait Frederick Sound/Stephens Passage Lynn Canal Icy Strait Seymour Canal Waterfall area Sitka Sound Chatham Strait
Prince William Sound	directional: SW, NW, SE, NE
Gulf of Alaska	
Hawaii	Auau Channel Oahu Penguin Bank Niihau/K. Rock Big Island Johnston sea mount Kauai
Japan	Chichi Jima Haha Jima Okinawa

Table 4
Description of sex codes

Sex code	Description
FC	Presumed female, seen with calf
FG	Known female, based on view of genital area
FGP	Known female, based on photograph of genital area
MS	Presumed male, singer
ME	Presumed male, escort of mother/calf pair
MG	Known male, based on view of genital area
MGP	Known male, based on photograph of genital area

numbers are assigned to each photograph, which is then coded into the computer data base, and the system is used to cross-match between the contributed collections.

Some individual humpback whales are represented by as many as 19 photographs, and some by only one, but at this stage a unique ID number is not assigned until there is at least a pair of matching photographs. To date, about 2,400 photographs have been cross-matched between photograph collections and assigned an ID number, representing about 790 individually identified whales.

Table 5.

Number of photographs in each recognition quality category

Recognition quality	Total	with ID
1 (excellent)	4,078	1,631
2 (moderate)	3,088	514
3 (poor)	1,885	87
not coded yet	302	173
Total	9,353	2,405

To test how well the computerized MATCH routine displayed known matches of various recognition qualities (RQ), 30 photographs of previously identified whales were selected randomly, stratified equally by RQ category. Since most whales fall into categories 1 and 2 (Table 5), this stratification method was weighted heavily towards testing the system's ability to match the poorer RQ photographs, assuming that the most distinctive photographs are more easily matched. For the purposes of this test, photograph quality (PQ) was ignored, although future testing will be stratified by both RQ and PQ.

Testing was conducted by a researcher experienced with matching using the computer system. However, the tester was not involved with data entry, nor with the development of the fluke codes. In addition, the tester's pattern and mark code selections in general vary consistently from those of the developers and the main data entry person. However, the tester has demonstrated a good eye for matches and is experienced and effective with the SCAN routine. Codes were entered with no coaching, using instructions straight from the system's user's guide. In addition, neither the tester nor the authors knew how many known matches existed for each randomly selected photograph.

Generally, the tester examined at least 5% of the data base (about 450 photographs), although in one case (of extreme patience) nearly 40% of the data base (3,501 photographs) was scanned. The decision to quit looking for matches was informal and somewhat arbitrary. The

SCAN/SELECT ENTRY SCREEN :

Choose selection criteria to select portions of the data base to scan on the video disc, or to produce a listing on the screen or printer:

SELECTION CRITERIA: (Use these or enter your own)

Sorted by: MARK2 MARK6 MARK12 MARK5 MARK11
MARK8 MARK14 MARK3 MARK9Where: (PATTERN EQ 31 OR PATTERN EQ 41)
AND MARK8 CONT M AND MARK12 CONT XL

WHERE Clause operators:

EQ	Equals	LT	Less than	GT	Greater than
NE	Not equal to	LE	Less or equal	GE	Greater/ equal
CONT	Contains	EXI	Exists	FAI	Fails

Fig. 5. Example of a SCAN screen.

protocol was simply to look at a minimum of 300 photographs, then quit when the rank changed, since any given photograph within a rank is equally likely to match to the 'new' whale. If the tester felt like looking at a lot of photographs, this was not discouraged. A more formal testing protocol will be established in the next phase of testing.

The testing was designed to examine how robust the coding criteria were with a new user, to check the performance and completeness of the similarity matrix, and to demonstrate how the system coped with photographs of all available PQ and RQ quality types.

In 13 of 30 cases, all known (and some new) matches were found. In most of those cases, all the known matches were found in the top 3% of the data base, even though in most cases the tester examined 5–15% of the data base (Fig. 6). In three cases, none of the known matches were found, although in each of these instances, poor PQ was clearly the factor in missing the match. Two of the three non-matched whales showed partial flukes (1/4–1/8 showing out of the water), and in the third, the photograph was printed extremely poorly.

Results of the MATCH testing demonstrate that first matches of excellent RQ photographs are found consistently within the top 1.0% of the data base. First matches of moderate RQ photographs were found in the top 1.9%. Of those poor RQ photographs for which

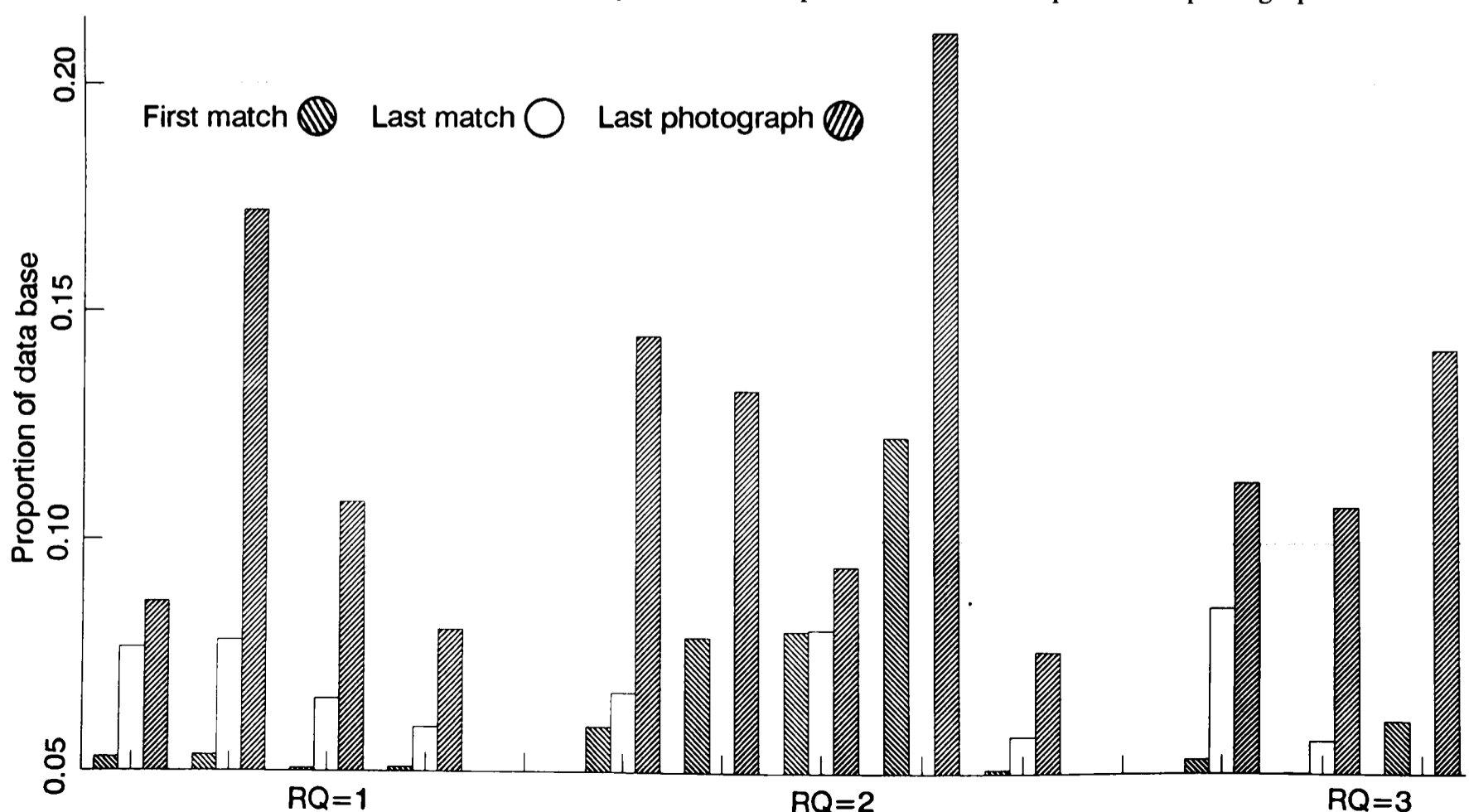

Fig. 6. Histogram of MATCH testing.

Table 6

Results of match testing, stratified by recognition quality (RQ).
Proportion of the data base searched is in parentheses. See text for explanation of the notes.

	Accession no.	PQ	Found/known	First found	Last found	Quit line	Notes
RQ=1	199	2	2/2	26 (0.0029)	240 (0.0265)	330 (0.0365)	
	2,039	3	2/2	31 (0.0034)	253 (0.0280)	1,104 (0.1220)	
	3,555	2	2/8	14 (0.0015)	96 (0.0106)	478 (0.0528)	
	3,696	2	1/4	30 (0.0033)		400 (0.0442)	PQ
	5,899	1	2/2	5 (0.0006)	140 (0.0155)	525 (0.0580)	
	6,813	2	9/12	1 (0.0001)	368 (0.0407)	418 (0.0462)	
	12,159	2	2/3	281 (0.0310)	384 (0.0424)	756 (0.0835)	
	877	2	7/11	42 (0.0046)	747 (0.0825)	824 (0.0910)	matrix 45/46
	28,257	1	6/19	3 (0.0003)	391 (0.0432)	640 (0.0707)	
	6,396	2	3/3	8 (0.0009)	85 (0.0094)	275 (0.0304)	
RQ=2	5,020	2	4/6	115 (0.0127)	579 (0.0640)	723 (0.0799)	1 new
	5,087	3	3/4	24 (0.0027)	259 (0.0286)	844 (0.0932)	matrix 63/43/33
	6,812	2	2/2	87 (0.0096)	153 (0.0169)	853 (0.0942)	
	8,161	3	3/4	236 (0.0261)	1,209 (0.1336)	1,346 (0.1487)	2nd try
	8,375	3	1/1	262 (0.0289)		745 (0.0823)	2nd try
	11,317	2	2/2	274 (0.0303)	277 (0.0306)	401 (0.0443)	
	20,209	2	1/1	654 (0.0723)		1,455 (0.1608)	
	28,314	3	4/19	95 (0.0105)	689 (0.0761)	871 (0.0962)	half fluke
	22,784	2	2/2	8 (0.0009)	72 (0.0080)	238 (0.0263)	
	27,041	2	2/3	10 (0.0011)	337 (0.0372)	638 (0.0705)	
RQ=3	273	2	6/6	28 (0.0031)	327 (0.0361)	573 (0.0633)	
	2,002	3	2/2	1 (0.0001)	63 (0.0070)	523 (0.0578)	
	3,227	3	2/5	675 (0.0746)	998 (0.1103)	1,200 (0.1326)	PQ
	6,817	3	1/3	105 (0.0116)		1,408 (0.1556)	1 new PQ
	8,177	3	0/1	-			PQ
	18,039	3	1/1	103 (0.0114)		831 (0.0918)	
	5,426	3	7/7	372 (0.0392)	3,501 (0.3868)	3,501 (0.3868)	matrix 12/41
	28,020	3	0/2	-		495 (0.0547)	1/8 fluke
	28,134	3	0/2	-		1175 (0.1298)	1/4 fluke
	28,156	3	1/2	574 (0.0634)		594 (0.0656)	

matches were found, the average was about 2.7% (Table 6). The RQ3 category was found to be confounded with PQ, and in many cases, RQ cannot be determined accurately for extremely poor PQ photographs.

In three instances, the similarity matrix was adjusted to include links that had been overlooked during initial system development (see notes on Table 6) and the results were reported using the adjusted matrix. In two cases (see notes on Table 6), a match was overlooked during the first test run and the tester was asked to re-enter the codes exactly as before and look again for the match. The results of the second try are reported in Table 6 and noted in the notes section.

In the 14 cases where some but not all matches were found, most of the misses could be attributed to poor PQ (either of the test photograph or of the known matching photographs in the data base).

Test results demonstrate that the system is robust to trained (but slightly biased) users, that the similarity matrix well delineates potential misclassified whales and that most matches can be found regardless of PQ, except in the most extreme cases.

DISCUSSION

The computerized matching system has the ability to handle massive photograph collections and has greatly reduced the time necessary to identify whales from new sightings. In addition to increasing the speed of matching new photographs, the flexibility of the sort criteria and the multiple iterations through the data base have also reduced

the number of false individuals (i.e. missed matches) in a catalog. The North Atlantic and North Pacific collections each process about 1,000–2,000 new photographs per year, contributed by many independent researchers and research groups. Processing this volume of data without computer assistance would be time-consuming and expensive.

Photographic techniques have been improving. The proportion of poor quality photographs has gone down each year, meaning a higher proportion of the data base will be effectively used.

To date, four research groups in the North Pacific have remote versions of the system (Glacier Bay National Park, Pacific Whale Foundation, Universidad Autonoma de Baja California Sur, and University of Hawaii) and suggestions for improvements from these researchers have been incorporated into the latest release. Software development and refinement is also in progress to improve speed of the MATCH routine and refinements to the ranking algorithm will be incorporated as soon as speed is improved.

There is wide research potential for the new system. It is now possible to work efficiently with large amounts of photographic data and many stocks of whales can be tracked over time and area. These new joint collections will provide a starting point for many collaborations that will provide new information on the life history, distribution, abundance and migration patterns of humpback whales. In addition, the techniques used here have general application to a wide variety of other photo-identification studies.

ACKNOWLEDGEMENTS

We thank all the researchers who participated in the Workshop held in Seattle in April 1986. They provided many important suggestions for system design before, during and after the Workshop. The spirit of collaboration of these and other researchers in the Pacific and Atlantic Oceans has made this work possible.

Researchers who have contributed photographs from the North Pacific include: Robin Baird, Scott Baker, Cascadia Research Collective, Center for Whale Research, Center for Whale Studies, Bill Dolphin, Glacier Bay National Park, James Hudnall, Jeff Jacobsen, Charles Jurasz, Bill Lawton, Lore Quest, Karen Moore, North Gulf Oceanic Society, Pacific Whale Foundation, John Reinke, Sea World Research Institute, Dana Seagars, Ed Shallenburger, Jan Straley, Tommy Thompson, Universidad Nacional Autonoma de Mexico, University of Hawaii/KBMML, William A. Watkins, West Coast Whale Research Foundation and Julia Whitty. See Katona and Beard (1990) for a list of contributors to the North Atlantic Humpback Catalog.

We also thank the staff members at the National Marine Mammal Laboratory and at the College of the Atlantic for helping to test and evaluate the system at various stages of development. We are especially grateful to Allen Wolman for helping test the system and providing photo-processing assistance and to Joan Rawling for her help in producing all of the whale identification video discs.

We note and appreciate the following special contributions: Barb Taylor first suggested categorizing flukes by pigment pattern; Dan McSweeney suggested the notch shape criteria; Astrid van Ginneken suggested useful software improvements and Ken Balcomb assisted in all phases of development of the new system.

Steve Larson and Marcia Muto drew the early versions of the pigment patterns and Harriet Corbett drew the final ones.

We thank the Pacific Whale Foundation for providing airfare for JAB to fly to Seattle for collaboration on the project.

Critical readings of this manuscript by Ken Balcomb, Howard Braham, Dawn Breese, Jeff Breiwick, Linda Jones, Steve Katona, Scott Kraus, Beth Miller, Jack Turnock and Allen Wolman have helped clarify the text.

We especially thank Sitha Hoy, who helped write system software, provided many useful suggestions during development of the system, and entered nearly all the North Pacific fluke codes. His wonderful eye and memory for fluke photographs is continuing to assist the computer in the ongoing matching process.

REFERENCES

- Fraday, T. 1987. Workshop on humpback whale photo-identification: A summary of proceedings. University of Alaska Sea Grant Report Number AK-SG-87-1.
- Hiby, A.R. and Lovell, P. 1990. Computer-aided matching of natural markings: a prototype system for grey seals. Paper SC/A88/ID9 (published in this volume).
- Katona, S.K. and Beard, J.A. 1990. Population size, migrations and feeding aggregations of the humpback whale, *Megaptera novaeangliae*, in the western North Atlantic Ocean. Paper SC/A88/ID2 (published in this volume).
- Perry, A., Baker, C.S. and Herman, L.M. 1990. Population characteristics of individually identified humpback whales in the central and eastern North Pacific: a summary and critique. Paper SC/A88/ID25 (published in this volume).

Computer Assisted Individual Identification of Sperm Whale Flukes

Hal Whitehead

Department of Biology, Dalhousie University, Halifax, Nova Scotia, Canada B3H 4J1

ABSTRACT

A system for the computer-assisted matching of photographs of flukes of individual sperm whales, *Physeter macrocephalus*, is described. The coordinates of points representing marks along the trailing edge of each fluke are entered into a personal computer using a digitizing tablet. Each point is represented by its proportional distance along the trailing edge of the fluke and an identifier giving the point type. Additional information about the shape of the fluke and circumstantial data (date, time, etc.) are entered through a keyboard. The routine computes measures of the quality of the photograph, and manages storage of data for each photograph. The program is designed to be fast when matching an input fluke against a stored catalogue. The routine was found to be acceptably fast (a photograph could be completely processed in 4–5 minutes) and, with photographs of reasonable quality, quite accurate.

INTRODUCTION

The ability to reliably identify individual animals from photographs of markings has been extremely important in recent research on several cetacean species (e.g. Arnborn, 1987; Bigg, Ellis, Ford and Balcomb, 1987; Katona and Beard, 1990; Payne, Brazier, Dorsey, Perkins, Rowntree and Titus, 1983). Individual identifications have permitted detailed studies of migration and residency (e.g. Darling and Jurasz, 1983; Whitehead, Harcourt and Silver, 1982), social behaviour (e.g. Whitehead, 1983; Whitehead and Arnborn, 1987), population dynamics (Hammond, 1986) and individual life histories (e.g. Bigg *et al.*, 1987; Clapham and Mayo, 1987; Payne *et al.*, 1983).

As more individuals within a population are identified, identification catalogues grow and the physical process of identifying individuals becomes increasingly more cumbersome. Each new photograph has to be compared with all previously identified individuals. This takes an increasingly greater time and skill, and adds to the probability of error in identification (Katona and Beard, 1990; Whitehead and Waters, 1990). In order to try to reduce the labour and increase the accuracy of identification analysis, computer-assisted matching schemes are being developed (Hiby and Lovell, 1990; Mizroch, Beard and Lynde, 1990).

Systems recently developed or under development vary from those in which an operator enters information about features of a photograph through a keyboard (Mizroch *et al.*, 1990) to those in which the whole process of digitizing the photograph, recognizing its salient features and comparing with a catalogue, is automated (McGowan, 1988). In all currently implemented procedures, the system produces a list of potential matches between the input photograph and the current catalogue with the final decision as to the match being made by an operator. In assessing the utility of a computer-assisted matching system the three most important factors are probably:

(1) *Accuracy*. How frequently does the program suggest the correct match, or include the correct match near the top of a list of potential candidates, and how reliably can the program suggest that there are no correct matches in the current catalogue?

- (2) *Speed*. How long does it take to input the data from a photograph to the computer, and, more importantly, how long does it take the computer to match an input photograph against a catalogue of a given size?
- (3) *Cost*. What is the cost of the hardware and software needed to implement the system?

Individual sperm whales, *Physeter macrocephalus*, can be identified from photographs of their flukes (Arnborn, 1987). Currently we have a catalogue of 1,015 individuals from the Galápagos Islands, Ecuador, and, given the probable structure and size of the stock of sperm whales in the region (Whitehead and Waters, 1990), after a few more field seasons its size should increase considerably. Therefore, we were interested in developing a computer-assisted matching system to help handle these data.

Sperm whales are principally identified by marks on the trailing edges of their flukes (Arnborn, 1987). This is basically a one-dimensional pattern (Fig. 1) and suggests that a relatively simple matching routine may be useful. My goals in designing the system described in this paper were to minimize the time (and thus labour expenses) taken to match flukes while using cheap, readily available, hardware and software and achieving a reasonable degree of accuracy in the matching process. In addition to carrying out the matching, the system described here also collects information on the quality of the photograph and manages the storage of identification and peripheral information.

THE SYSTEM

Hardware and software

The hardware needed to operate this system consists of a digitizing tablet connected to a personal computer with reasonable internal memory (see below) and one disk drive. The system was developed using a *CalComp* Drawing Board and *Zenith Z-140PC* IBM-compatible personal computer. Our current catalogue is now installed on a *Zenith Z-386 Model 40* with 8387 coprocessor. The parts of the program which draw representations of fluke patterns on the screen require a VGA monitor system. The program is written in BASIC, and, for small catalogues,

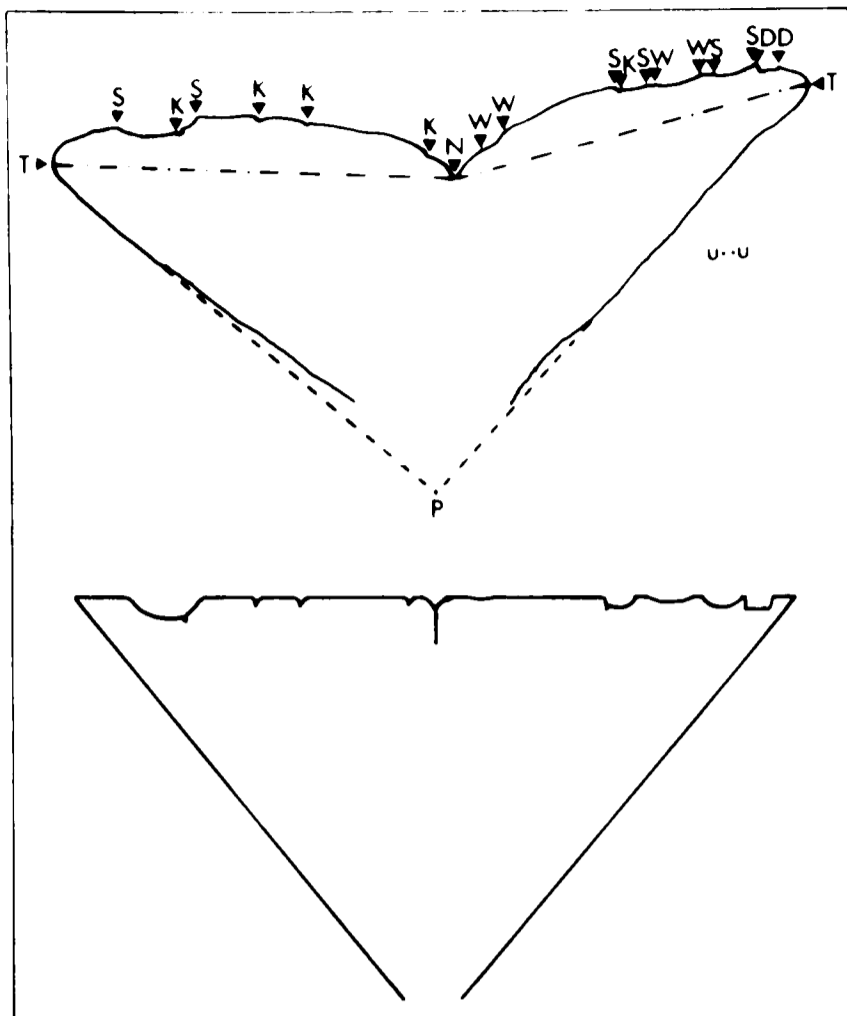

Fig. 1. Information taken from sperm whale fluke by digitizer: fluke tips (T), notch (N), marks along trailing edge of fluke (K, S, W, D), meeting point of sides of fluke (P), and two points giving an index of resolution (U). Points are projected onto lines (dash-dot-dash) joining the notch to the fluke tips. The computer-drawn representation of the same fluke is shown beneath.

could be run using the standard BASIC interpreter. However, for catalogues of any substantial size, a compiler, such as *Microsoft QuickBasic 4.0*, is necessary, and in all cases it is highly recommended as it greatly increases the speed of the program. Complete hardware and software to process a catalogue of over 1,000 individuals could be purchased for less than \$2,000 in the USA.

Entry of circumstantial information

For each photograph to be matched, the program initially calls for the entry of peripheral circumstantial information (which is later recorded with the results of the matching) from the keyboard: year, month, day, time, photographic roll number and frame number. In entry of subsequent photographs, the typing of some of this information can be eliminated.

Input of identification markings

The image of the flukes to be matched is placed on the digitizer using either a projector for slides, an enlarger for negatives or physically with prints. Coordinates of a series of points on the trailing edge of the flukes are input into the computer by first pressing a one letter code on the computer keyboard (Table 1) and then, with the digitizer cursor over the corresponding point on the image, the button on the cursor. Points are input from left to right, unless the photograph was taken from the ventral side of the flukes in which case they are input from right to left. The first and last points are the fluke tips and one of the intermediate points is the fluke notch. The different types

Table 1

Points input from digitizer with their one letter code and, for those points used in matching, their *identifier*.

Code	Description	Identifier
T	Fluke tip	-
N	Fluke notch	-
K	Small nick: small indentation in edge of fluke	1
D	Distinct nick: larger indentation sharply cut away	start 2 end 3
S	Scallop: deep smooth depression with depth > 20% of width	start 4 end 5
W	Wave: shallow smooth depression with depth ≤ 20% of width	start 6 end 7
M	Missing portion: large part of fluke missing, usually at tip	start 8 end 9
C	Toothmark scars: often seen as parallel white lines	10
H	Hole: hole through flukes	11
I	Invisible portion: part of flukes obscured	start 12 end 13

of points used are defined and listed in Table 1. This list is a slightly refined version of Arnbohm's (1987) list of identifiable features of sperm whale flukes. The entry of points on a fluke is illustrated in Fig. 1.

Entry of these data ends with the second fluke tip. The computer then checks that the list of input points includes one and only one fluke notch, and an even number of those points (distinct nick, wave, scallop, missing portion, invisible area) which require a start and finish point. If these conditions are not met, the data must be input again. A representation of the fluke pattern showing the features which were entered is then shown on the screen (Fig. 1) so that the operator can check that the input data were correct. At this point the data can be input again if the operator wishes.

Points are projected onto lines joining the tips to the fluke notch (Fig. 1) and the position of each is represented by a proportionate distance along the flukes, so that 0.05 represents a point near the left tip, 0.54 represents a point just to the right of the notch and 0.75 a point half way along the right fluke. Thus each point is represented by two numbers: one, the *coordinate*, is this proportionate distance along the fluke; the other, the *identifier* (Table 1), gives its type.

Additionally, the computer asks for information as to whether the notch is recognizably open or closed and whether either fluke tip is recognizably curled (Arnbohm, 1987).

The complete information extracted from the fluke shown in Fig. 1 is presented in Table 2.

Quality of photograph

Arnbohm (1987) found that the certainty of identification from a sperm whale fluke photograph depended on various physical features of the image: the orientation of the fluke to the camera about a vertical axis (orientation), the tilt of a fluke away from the vertical (tilt), and measures of the resolution available on the image (focus sharpness, size of image). The matching program estimates orientation (Θ) tilt (ϕ) and resolution (r) using data input from the digitizer.

The operator places the cursor over the point P where extensions of the two sides of the image of the fluke meet (Fig. 1), and presses the button. Point P and points

Table 2

Information extracted from the fluke in Fig. 1.

Catalogue identification number:	468
Number of points:	17
Points: Coordinate (identifier)	
0.0858 (4) 0.1637 (1) 0.1833 (5) 0.2670 (1) 0.3450 (1) 0.4733 (1)	
0.5482 (6) 0.5822 (7) 0.7415 (4) 0.7550 (1) 0.7867 (5) 0.7962 (6)	
0.8651 (7) 0.8760 (4) 0.9338 (5) 0.9425 (2) 0.9623 (3)	
Fluke notch:	Closed
Curled tips:	
Orientation, Θ :	22°
Tilt, ϕ :	10°
Resolution, r:	11
Date:	10/03/85
Time:	17 55
Roll:	GH46
Frame:	6

representing the fluke tips form a triangle. The lengths of the sides of this triangle can be calculated from the digitized coordinates of its apices. If the width (tip-to-tip) of the image of the fluke is w , and the other two sides are a and b , then we can estimate Θ and ϕ from:

$$\begin{aligned} \cos(\Theta) &= \sqrt{\{(1+h^2+d^2 - \sqrt{((1+h^2+d^2)^2-4h^2)})/(2h^2)\}} \\ \cos(\phi) &= \sqrt{\{(1+h^2+d^2 - \sqrt{((1+h^2+d^2)^2-4h^2)})/2\}} \end{aligned}$$

where:

$$d = (a^2-b^2)/(2\alpha w^2)$$

[$d\alpha$ is how much P is offset from the centre of the trailing edge of the flukes, as a proportion of the width of the flukes]

$$h = \sqrt{\{(a+b+w).(a+b-w).(a+w-b).(b+w-a)\}/(2\alpha w^2)}$$

[$h\alpha$ is the ratio of the height to the width of the fluke image]

and α is the ratio of the height to the width of a fluke with no orientation or tilt. From an examination of several photographs with no apparent tilt or orientation this was estimated to be $\alpha = 0.46$.

After the input of point P allowing estimation of Θ and ϕ , the operator enters two points from the digitizer (e.g. U's in Fig. 1). The distance between these two points indicates the resolution of the image. If the distance between these points is δ , then an index of resolution, r , is given by:

$$r = -2.\text{Log}(\delta/w)$$

These three measures, Θ , ϕ and r , are used as indicators of the quality of each image. They are given for the photograph in Fig. 1 in Table 2.

The catalogues and its subcatalogues

After the program is entered, the current catalogue of sperm whale flukes is read into memory. The information stored for each whale is: its identity number (Arnbom, 1987), and, for the best photograph of it, the number of recognizable points on the fluke, their *coordinates* and *identifiers*, information as to the type of notch or whether the tips are curled (stored using a unique integer for each possible combination of such information), Θ , ϕ , r , the date, time, roll and frame number (see Table 2).

An indicator of the total value of the information on each catalogue fluke x , $M(x,x)$ (see below), is calculated

and used to allocate the flukes to one of three sub-catalogues (Subcatalogue 1: $M(x,x) < 10$; Subcatalogue 2: $10 \leq M(x,x) < 20$; Subcatalogue 3: $20 \leq M(x,x)$).

Matching

After the input data have been checked by examining the representation, the indicator of the total value of the information in each input image y , $M(y,y)$, is calculated. The subcatalogues are then searched in order of the likely match being found in each one. For instance, if $M(y,y) = 11$ the subcatalogues are searched in the order 2, 1, 3.

The input image, y , is matched against all flukes, x , in each subcatalogue. For each point i on fluke x (with *coordinate* $c(x,i)$ and *identifier* $I(x,i)$) and each point j on fluke y (with *coordinate* $c(y,j)$ and *identifier* $I(y,j)$), a similarity value $F(x,i,y,j)$ is calculated:

If $|c(x,i)-c(y,j)| \geq D(I(x,i),I(y,j))$, then:

$$F(x,i,y,j) = 0$$

If $|c(x,i)-c(y,j)| < D(I(x,i),I(y,j))$, then:

$$F(x,i,y,j) = \frac{V(I(x,i),I(y,j)) \cdot \{1 - |c(x,i)-c(y,j)|\}}{D(I(x,i),I(y,j))} \quad [1]$$

Given the types of the two points ($I(x,i),I(y,j)$), the similarity is zero if the two points are further apart than the assigned value of D for two points of these types. If they are closer than D , the similarity, F , takes a value V (assigned for two points of these types) reduced by the ratio between the distance apart of the two points and D . So, if two points have the same coordinate then $F = V$; if they are $D/2$ apart $F = V/2$. Assigned values for V and D for all pairs of point types are given in Tables 3 and 4.

Table 3

V matrix: value of matches between points of different types, represented here by their identifiers.

Identifier:	1	2	3	4	5	6	7	8	9	10	11
1	1.0	1.5	1.5	0.7	0.7	0	0	0	0	0	0.3
2	1.5	2.0	0	1.5	0	0.8	0	0.5	0	0	0
3	1.5	0	2.0	0	1.5	0	0.8	0	0.5	0	0
4	0.7	1.5	0	2.0	0	1.0	0	0.5	0	0	0
5	0.7	0	1.5	0	2.0	0	1.0	0	0.5	0	0
6	0	0.8	0	1.0	0	1.0	0	0	0	0	0
7	0	0	0.8	0	1.0	0	1.0	0	0	0	0
8	0	0.5	0	0.5	0	0	0	2.0	0	0	0
9	0	0	0.5	0	0.5	0	0	0	2.0	0	0
10	0	0	0	0	0	0	0	0	0	2.0	0
11	0.3	0	0	0	0	0	0	0	0	0	2.0

Using the calculated F 's for each pair of points, an indicator of the amount of agreement between x and y , $M(x,y)$, the match coefficient, is calculated:

$$M(x,y) = \text{Max} \left\{ \sum F(x,ik,y,jk) \mid ik \neq il, jk \neq jl \text{ if } k \neq l \right\} + n(x,y) \cdot v'$$

$i1, i2, \dots, ik, jk$
 $j1, j2, \dots$

M is the maximum sum of the similarities (F 's) subject to the condition that each point on each fluke can only be matched with one point on the other fluke, plus the number of coincidences of peripheral information (open or closed fluke notch, left or right tip curled), $n(x,y)$, multiplied by the assigned value of each such coincidence, v' . So if both flukes had open fluke notches and a curled left tip then $n=2$. The assigned value of v' was 0.5.

Table 4

D matrix: precision of matches between points of different types, represented here by their identifiers.

Identifier:	1	2	3	4	5	6	7	8	9	10	11
1	0.025	0.040	0.040	0.040	0.040	0	0	0	0	0	0.025
2	0.040	0.040	0	0.040	0	0.060	0	0.040	0	0	0
3	0.040	0	0.040	0	0.040	0	0.060	0	0.040	0	0
4	0.040	0.040	0	0.040	0	0.060	0	0.040	0	0	0
5	0.040	0	0.040	0	0.040	0	0.060	0	0.045	0	0
6	0	0.060	0	0.060	0	0.067	0	0	0	0	0
7	0	0	0.060	0	0.060	0	0.067	0	0	0	0
8	0	0.040	0	0.040	0	0	0	0.040	0	0	0
9	0	0	0.040	0	0.045	0	0	0	0.040	0	0
10	0	0	0	0	0	0	0	0	0	0.060	0
11	0.025	0	0	0	0	0	0	0	0	0	0.040

The value of each fluke, $M(x,x)$ was given by the above formulae when a fluke was matched against itself. This is equivalent to:

$$M(x,x) = \sum_i V(I(x,i), I(x,i)) + n(x,x).v'$$

where $n(x,x)$ is the number of pieces of peripheral information (open or closed fluke notch, left or right tip curled) available for fluke x .

If there are invisible portions (parts of fluke underwater, obscured by spray, outside the photographic image) on a fluke x , then, when x is matched against a fluke y , points on y with coordinates within the invisible region of x are omitted from the calculation of $M(y,y)$.

Finally a match coefficient between x and y , $R(x,y)$, is calculated from:

$$R(x,y) = \text{Min} \{M(x,y)/M(x,x), M(x,y)/M(y,y)\} \quad [2]$$

So, this coefficient, R , which varies between 0.0 (nothing similar between flukes x and y) and 1.0 (identical information on the two flukes), gives an indication of how closely the information on the two flukes agrees compared with the value of the information on the most complex flukes of the pair.

As it searches the subcatalogues, the program displays a list of those matches with $R > 0.1$ (or the 20 best matches if more than 20 catalogue flukes have an $R > 0.1$) together with the catalogue identification number and match coefficient for each match in the list. The list is sorted so that the highest R value is at the top of the screen, and the list is updated whenever a match better than that at the end of the list is discovered. The program also displays a message as it finishes searching each subcatalogue. This procedure allows the operator to visually examine a catalogue of photographic prints while the computer matching is in progress, and to know when all the most likely flukes (those in the subcatalogue searched first) have been examined. The matching routine can be stopped when the operator has found a correct match or for other reasons. If it is not stopped, all flukes in all three subcatalogues are compared with the input fluke.

Choice of match

After matching has been stopped or has run its course, the operator may, on request, view representations of any flukes in the catalogue on the screen (usually those belonging to flukes at the top of the match list). The program then asks for an identification number for the input fluke or whether the fluke is not in the catalogue and should be added to it (the matching can also be aborted at

this stage). If a new fluke, the operator enters a new identification number for it, and its information is added to the catalogue. If matched with a catalogue fluke, the operator is asked whether the new information should replace the catalogue information (this is usually done if the new fluke is of superior quality to the old one).

The operator is then asked to give an indicator of the certainty of the match or lack of it on a scale of 1–5 [the 'Q' value of Arnbohm (1987)]: '5' indicates excellent information and absolute certainty, '1' very little confidence in the match or lack of it. Information about the input fluke is then stored in two files. The 'IDFile' includes date, time, roll, frame, identification number and 'Q' for each input frame, and is the file generally used for subsequent analysis of populations, migrations and social behaviour. The 'DataFile' contains this information plus information on the matching process (R values of the chosen match and best match; Θ , ϕ and r for both the input fluke and the chosen match) so that the identification and matching process can be analysed further.

NOTES ON THE DESIGN OF THE ROUTINE

Speed

Several features of the routine were designed for speed of data entry and matching:

- (1) a simple characterization of the fluke pattern is used, speeding data entry, minimizing storage and the time spent calculating matches;
- (2) the amount of stored information is kept as small as possible. This allows the entire catalogue to be kept in memory, eliminating slow access to other storage media (such as hard or floppy disks) – to do this, for each point one single-length integer number is used which combines the identifier (I) and coordinate (c);
- (3) almost all variables are stored as integers and almost all arithmetic is integer arithmetic, greatly increasing the calculation speed;
- (4) the use of subcatalogues means that the correct match, if there is one, is likely to be found quickly – at this point the matching can be halted;
- (5) when comparing points on a pair of flukes, only points within 0.067 of one another (the maximum value of D) are compared.

Optimization of parameters

A test set of 70 photographs, two from each of 35 randomly chosen different whales (of a variety of qualities, some of which were poorer than those generally used for positive

identification, 'Q' < 4) was used to adjust the routine to improve its performance. Initial values of the V and D matrices and v' were set after a careful examination of which identifiers were likely to be confused on pairs of photographs of the same whale and how much the coordinates calculated for each feature varied between photographs. Then, using the test set, each fluke was matched against all others, and the number of flukes which did not have the highest R match coefficient with their correct companion photograph was counted (WRONG). A secondary measure of the success of the routine was the average ranking of the correct companion (EXCESS). Several aspects of the routine were adjusted using this test set:

- (1) the importance of precision (how close points needed to be together to be matched) on the matching was tested using several different constant scalar multipliers for the D matrix (Table 3) – the multiplier which minimized WRONG, and secondarily EXCESS, was retained;
- (2) the precision used for matches of waves on one another seemed quite crucial (D(6,6) and D(7,7)) – these values were altered to find an optimal value (minimizing WRONG and EXCESS);
- (3) from an examination of the problem matches, some other D and V values were altered;
- (4) the relative value of peripheral fluke notch and curled fluke tip information, v', was examined – v' was altered until an optimal value (minimizing WRONG and EXCESS) was found;
- (5) an exponent, e, was added to equation [1] so that the relative value of coincidences between points at different proportions of D from one another could be changed

$$F(x,i,y,j) = V(I(x,i),I(y,j)) \cdot \{1 - c(x,i)-c(y,j) / D(I(x,i),I(y,j))\}^e$$

— leaving e=1 as in [1] was found to work at least as well as with other e values;

- (6) equation [2] was replaced by various linear combinations of $\text{Max}\{M(x,y)/M(x,x), M(x,y)/M(y,y)\}$ and $\text{Min}\{M(x,y)/M(x,x), M(x,y)/M(y,y)\}$ – simply using the Min value, as in equation [2], was found to work best.

These optimizations all took considerable computer time and so additional optimization of the matching routine was not practical. However, in general, reasonable changes to particular parameters or details of the routine seemed to make little difference in EXCESS or WRONG. Therefore, it is likely that the accuracy of this routine (as measured by EXCESS and WRONG on the test data set) cannot be much improved by changes to parameters or the equations defining the match coefficient.

PERFORMANCE OF ROUTINE

Accuracy

The accuracy of the routine when running with a catalogue of 1,015 individuals was tested using 56 new photographs of individuals in the catalogue. The photographs were selected to be representative of the different patterns of markings found on Galápagos sperm whales by choosing from 15 sections of the visual catalogue, each with similar fluke patterns, in proportion to the number of individuals in that section. The testing was not carried out by the

person who entered the catalogue information. Photographs were chosen of most qualities ('Q'-values from 2–5) although very poor images (which would usually have 'Q' values of 1 and be unrecognizable) were omitted, and, as the best image of each fluke was already in the catalogue, there may be an underrepresentation of very high quality images ('Q'-value of 5). This set was distinct from the test set used to optimize the routine, as described above.

The performance of the routine in matching these photographs is summarized in Tables 5 and 6. Eighteen of the 56 test photographs, or 32%, were correctly matched, and 33 of the photographs, or 59%, had the correct match in the first 10 possibilities. If only the higher quality ('Q'=4 or 5) matches, those used for subsequent population analysis, are considered, 57% (17/30) were correctly matched and 80% (24/30) were in the first 10 possibilities.

For each pair of photographs (the test photograph and its true companion in the catalogue), the maximum values of Θ (orientation) and ϕ (tilt), and the minimum value of r (resolution) were used as indicators of the quality of the photographs from which the match was made (Table 5). In Fig. 2 the maximum values of Θ and ϕ are plotted against each other, with indications of the success of the matching routine, for the test photographs. It is clear that when Θ , the orientation, is less than 35° and ϕ , the tilt, is less than 30° the matching routine was much more successful (10/14 = 71% first or second in the match list and 12/14 = 86% on list) than when these conditions were not met (only 11/42 = 26% first or second on list and 26/42 = 62% on list). The value of r, resolution, seemed to affect the matching performance less critically (Table 5).

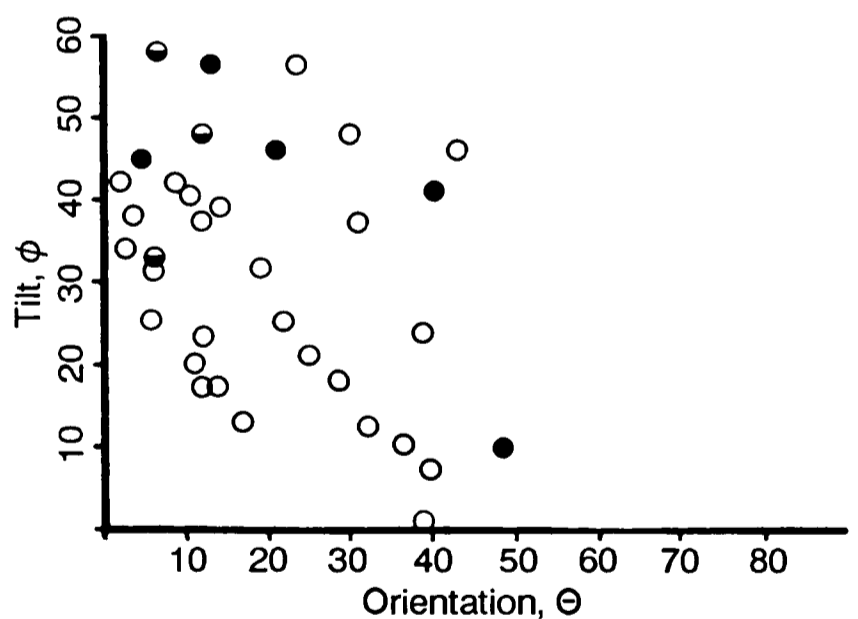

Fig. 2. Accuracy of matching routine with orientation, Θ , and tilt, ϕ , of fluke. Each symbol represents the greatest tilt and orientation of the test photograph and its true match in the catalogue. The symbol is open if the true match was the first or second selected by the matching routine out of a catalogue of 1,015, hatched if the true match was ranked 3–20, and filled if the true match was not in the 20 selected by the routine. Circles represent those matches with 'Q' values of 4 or 5, which are used in subsequent population analysis, squares represent matches of 'Q' values 2–3.

When the 56 test photographs were matched against our catalogue of 1,015, R(I), the highest incorrect match coefficient, had a mean value of 0.490 (SD 0.064). This meant that if the highest match coefficient was greater than 0.55 it was generally correct, and if lower than 0.50 it was generally incorrect (Table 6).

Table 5

Performance of the matching routine when a test set of 56 fluke photographs was matched against a catalogue of 1,015 individuals. This table categorizes the test photographs based on the rank of the correct photograph in the list of matches. The number of test photographs, and the number of high quality test photographs ("Q"=4 or 5), is given for each category along with the mean orientation (Θ), tilt (ϕ), resolution (r), and match coefficient of correct match (R).

Rank of correct match	Number		Mean			
	Total	"Q"=4 or 5	Θ	ϕ	r	R
1	18	17	18	30	11.6	0.558
2	3	0	18	28	11.7	0.491
3-10	12	7	11	34	11.5	0.406
11-20	5	2	21	36	11.4	0.342
>20	18	4	18	38	10.6	-
All	56	30	17	34	11.2	-

Table 6

Matching success as indicated by highest match coefficient (R) produced by routine when matching 56 test photographs against catalogue of 1,015 flukes.

Highest R	Correct matches	Incorrect matches	Proportion correct
<0.4	0	2	0.0
0.4-0.45	1	6	0.14
0.45-0.5	1	18	0.05
0.5-0.55	7	7	0.50
0.55-0.6	4	2	0.67
>0.6	5	3	0.63

Speed

The time taken for an operator to type in circumstantial information (date, time, roll, frame, etc.) and enter the identification markings and photograph quality information from the digitizer is about 1-2 min. The average time taken to compare pairs of flukes in the test data set is 0.2s using the *Zenith Z-140* PC and 0.02s for the *Zenith Z-386*. The time taken to compare a pair of flukes varies with the information on them - with more information the comparison takes longer. With our current catalogue of 1,025 identified individuals on the *Zenith-386* Model 40, matching a new photograph against the entire catalogue takes 30-60s depending on the complexity of the information on the photograph. In practice, many search times are shorter than this as the search can be halted when the correct match is found in the first subcatalogue searched.

With a catalogue of 1,015 individuals on the *Zenith Z-386*, an average total 'turnaround' time (including entry of circumstantial information and coordinates from digitizer, matching, choice of match and data storage) is about 4-5min per photograph.

Size of catalogue

The current version of the program running on a machine with 1mB memory appears to be able to hold catalogues containing at least 3,000 individuals, although it has not been tested in practice with catalogues of this size.

DISCUSSION

This routine is proving to be of considerable assistance to us in matching and cataloguing sperm whale flukes. We obtain of the order of 1,000 fluke photographs from about 300 individuals per field season. These usually take several months of work by one operator to match against the current catalogue, check and document, and a few errors are invariably incorporated. With the routine described in this paper 1,000 fluke photographs can be processed in the order of 50 hrs. The savings in labour costs quickly outweigh the value of the hardware and software purchased. Additionally, the routine should reduce the number of matching errors. It usually finds the correct match with high quality photographs ($\Theta < 35^\circ$ and $\phi < 30^\circ$). Performance will usually be somewhat better than as indicated in the tests described in this paper because of the exclusion of very high quality photographs from the set used to examine the performance of the routine. Additionally, normally the same operator will usually enter all photographs so that subconscious conventions can increase consistency.

The routine does not always find the correct match, so that the ability of the operator is vital. However, in many cases the routine can greatly speed up the matching process. For photographs with low values of tilt and orientation, where an R value of greater than 5.5 is displayed, the routine will generally signal the true match. Its greatest drawback is that, when used with large catalogues, it cannot definitively show that a new photograph is not already in the catalogue. This means that a new photograph must be visually checked carefully against much or all of the catalogue so that duplicates are not included. When our complete photographic collection is digitized, we plan to run the catalogue through an amended program which lists pairs of catalogued whales which have high similarity values. In this way we should be able to nearly eliminate unintentional duplicates in the catalogue.

The routine will help the rigorous determination of what is a 'high quality' photograph, suitable for inclusion in data sets for mark-recapture population estimation techniques (Hammond, 1986), and should pick up most cases where there has been moderate change in the pattern of marks over a period of time.

This routine differs from others developed for computer-assisted matching of marine mammal identification photographs principally in that it uses a small amount of rather precise data (the coordinates of the points on the trailing edge of the fluke) to characterize each photograph. In contrast, Hiby and Lovell's (1990) routine for computer-aided matching of seal pelage markings uses many more pieces of information (a digitization of the pelage pattern) while Mizroch *et al.* (1990) use generalized descriptions of overall patterns and the placement of marks in broad regions to sort humpback whale, *Megaptera novaeangliae*, flukes. The small number of points used in the sperm whale routine described here is crucial to its speed. Hiby and Lovell's (1990) routine takes about 2s to match each pair of patterns on a 16 bit desktop computer, as compared to 0.02s for our system.

Procedures similar to that described in this paper may prove useful when a small amount of rather precise and individually variable data can be extracted from an identification photograph. Possible examples might include the pattern of scallops along the trailing edges of

humpback whale flukes and the shape and marks on dorsal fins of some cetacean species. However when identification is done from more variable, complex and less precise marks, such as the seal pelage patterns, it is hard to see how modifications of the technique described here would prove useful. In these cases the approach taken by Hiby and Lovell (1990) seems most promising.

Copies of the routine will be made available to interested scientists on request.

ACKNOWLEDGEMENTS

I am grateful to Kenny Richard and, especially, Susan Waters who helped with the development of this technique and to Sandra Walde for the opportunity to run the routine on her computer. The research was funded by the Natural Sciences and Engineering Research Council of Canada and the Dalhousie University Research Development Fund. Two anonymous reviewers provided useful comments on the manuscript.

REFERENCES

- Arnbom, T. 1987. Individual identification of sperm whales. *Rep. int. Whal. Commn* 37: 201-4.
- Bigg, M.A., Ellis, G.M., Ford, J.K.B. and Balcomb, K.C. 1987. *Killer Whales. A Study of their Identification, Genealogy and Natural History in British Columbia and Washington State*. Phantom, Nanaimo, British Columbia. 79pp.
- Clapham, P.J. and Mayo, C.A. 1987. Reproduction and recruitment of individually-identified humpback whales, *Megaptera novaeangliae*, observed in Massachusetts Bay, 1979-1985. *Can. J. Zool.* 65: 2853-63.
- Darling, J.D. and Jurasz, C.M. 1983. Migratory destinations of North Pacific humpback whales (*Megaptera novaeangliae*). pp.359-68. In: R.S. Payne (ed.) *Communication and Behavior of Whales*. Westview Press, Boulder, Colorado. 643pp.
- Hammond, P.S. 1986. Estimating the size of naturally marked whale populations using capture-recapture techniques. *Rep. int. Whal. Commn* (special issue 8): 253-82.
- Hiby, L. and Lowell, P. 1990. Computer-aided matching of seal pelage markings. Paper SC/A88/ID9 (published in this volume).
- Katona, S.K. and Beard, J.A. 1990. Population size, migrations and feeding aggregations of the humpback whale (*Megaptera novaeangliae*) in the western North Atlantic Ocean. Paper SC/A88/ID2 (published in this volume).
- McGowan, M.F. 1988. Whale image processing for data archival and individual identification. Paper SC/A88/ID8 presented to IWC Workshop on Individual Identification of Whales, La Jolla, California, May 1988 (unpublished).
- Mizroch, S.A., Beard, J.A. and Lynde, M. 1990. Computer assisted photo-identification of humpback whales. Paper SC/A88/ID11 (published in this volume).
- Payne, R., Brazier, O., Dorsey, E.M., Perkins, J.S., Rowntree, V.J. and Titus, A. 1983. External features in southern right whales (*Eubalaena australis*) and their use in identifying individuals. pp.371-445. In: R.S. Payne (ed.) *Communication and Behavior of Whales*. Westview Press, Boulder, Colorado. 643pp.
- Whitehead, H. 1983. Structure and stability of humpback whale groups off Newfoundland. *Can. J. Zool.* 61(6): 1391-7.
- Whitehead, H. and Arnbom, T. 1987. Social organization of sperm whales off the Galápagos Islands, February-April 1985. *Can. J. Zool.* 65(4): 913-9.
- Whitehead, H., Harcourt, P. and Silver, R. 1982. The migration of the humpback whales along the northeast coast of Newfoundland. *Can. J. Zool.* 60: 2173-9.
- Whitehead, H. and Waters, S. 1990. Social organization and population structure of sperm whales off the Galápagos Islands, Ecuador (1985 and 1987). Paper SC/40/SP3 (published in this volume).

DNA Fingerprinting Cetacean Biopsy Samples for Individual Identification

Bill Amos and A. Rus Hoelzel

Department of Genetics, Downing Street, Cambridge, UK

ABSTRACT

The technique of DNA fingerprinting allows unambiguous identification of human individuals, can be performed on very small pieces of tissue and is stable with time. We show here that DNA fingerprinting is also applicable to the study of cetacean species. Samples may be collected from dead animals, live captured animals or remotely using a biopsy dart. We present a method, using internal standards and a sonic digitiser, for standardising data input with a view to the creation of data bases. The advantages, limitations and cost of the technique are discussed.

INTRODUCTION

The individual identification of animals is important in the study of natural populations, allowing capture-recapture estimates of population size and other parameters and the monitoring of migration patterns (Hammond, 1986; IWC, 1990). For species such as cetaceans, which are highly mobile and logistically difficult to observe, this is especially so, since many other experimental approaches are inappropriate.

At present, individuals are recognised either photographically, using some natural characteristic such as scarring, fluke notches and variable colouration or by artificial marking, using some form of coded tag.

Recent advances in molecular biology have uncovered a third option*. DNA fingerprinting is the name given to a genetic technique which has the capacity to resolve sufficient genetic variation for individuals to be identified with very small probabilities of misidentification (Jeffreys, Wilson and Thein, 1985a). Although originally developed in humans (Jeffreys, Wilson and Thein, 1985b), it has since been found applicable to a wide variety of other organisms including birds (Wetton, Carter, Parkin and Walters, 1987; Burke and Bruford, 1987), mice (Jeffreys, Wilson, Kelly, Taylor and Bulfield, 1987; Elliot, 1986), plants (Dallas, 1988), dogs (Jeffreys and Morton, 1987; Morton, Yaxley, Patel, Jeffreys, Howes and Debenham, 1987), yeast (Ryskov, Mazurchuk, Syrokvashva and Beritashvili, 1989) and many cetacean species (Amos, Barrett and Dover, in prep.; Hoelzel and Amos, 1988). The amount of tissue required is very small, of the order of tens of milligrams, and may be collected remotely from free-swimming animals using a small biopsy dart (Hoelzel and Amos, 1988; Arnason, Bellamy, Eyporsson, Lutley, Sigurjónsson and Widegren, 1985; Lambertsen, 1987; Mathews, Keller and Weiner, 1988).

A DNA fingerprint visualises genetic variability at the level of the DNA itself, simultaneously detecting a large number of independent, autosomal loci (Jeffreys, Wilson, Thein, Weatherall and Ponder, 1986). These loci form a family of related sequences, each of which experiences a rate of mutation one or more orders of magnitude higher than that observed for the vast majority of other sequences. The resolution of a DNA fingerprint is greater

than that obtained by screening 50 highly polymorphic isozyme loci. This is because a large number of fragments can be discriminated and each is hypervariable. One human locus examined by Wong, Wilson, Jeffreys and Thein (1986) revealed 77 different alleles in 79 individuals studied.

The key to the fingerprinting system lies with a family of short repeated sequences, known as minisatellites (the term satellite is used to describe any highly repeated piece of DNA). These lie in tandemly arranged clusters on most somatic chromosomes. At the centre of each repeat is a conserved 'core' sequence only 12–16 base pairs (the building blocks of DNA) in length (Jeffreys *et al.*, 1985b). The remainder to each repeat unit is made up of more divergent, yet related, flanking sequences.

High levels of variability in repeat copy number are observed (Jeffreys, Royle, Wilson and Wong, 1988), thought to be due to frequent genetic rearrangements (Chandley and Mitchell, 1989) and this is reflected in the length of each array. A DNA fingerprint visualises length variants at many minisatellite loci simultaneously (Jeffreys *et al.*, 1987; Wong *et al.*, 1986; Jeffreys *et al.*, 1988).

The rate at which novel length variants arise has been measured in humans by the analysis of known pedigrees. It is found that detectable mutations occur at an average rate of about 10^{-4} per kilobase (1,000 base-pairs=1Kb) per generation. For a species with 50 detectable minisatellite loci per individual, each with an average length of 5Kb, this would be equivalent to one observed mutation occurring every 40 generations. Such a rate results in a calculated probability of two humans sharing the same fingerprint of about 10^{-20} (Jeffreys *et al.*, 1986). Clearly there is little ambiguity involved. Indeed the technique has already been used successfully as evidence in legal proceedings to convict individuals accused of rape and murder (Gill, Jeffreys and Werrett, 1985). Furthermore, by subtracting the maternal component from her offspring's fingerprint, it is possible to generate a partial fingerprint that must have been inherited from the offspring's father. Positive paternity analysis is thus possible by comparing this subset of bands with the fingerprints from a range of potential fathers. This method has not only been used successfully on humans in immigration test-cases (Jeffreys, Brookfield and Semeonoff, 1985), but has been extended to assign paternity in natural populations of birds (Wetton *et al.*, 1987) and pilot whales (Amos *et al.*, submitted).

* Readers without a 'genetic' background should consult the review by Hoelzel and Dover (1989) which also includes a glossary.

Most of the published work on the estimation of mutation rates and other similar parameters at minisatellite loci has been restricted, in general, to humans. Results emerging from other animals indicate that man and several bird species are the most variable organisms. However, this may simply be the result, in part, of the greater amount of work applied to these systems. As the system is optimised and the range of alternative hypervariable sequence probes expands, the number of species which prove difficult to fingerprint will decrease. There are already available many synthetic (Schafer, Zischler and Eppel, 1988) and non-human probes (Georges, Cochaux, Lequarre, Young and Vassart, 1987; Vassart, Georges, Monsieur, Brocas, Lequarre and Christophe, 1987) to augment the original 33.15 and 33.6 clones isolated by Jeffreys.

Fingerprint patterns themselves resemble supermarket bar codes, comprising ladders of bands which vary in both position and intensity. As such they can be expressed in simple binary notation and are therefore ideally suited to a computer database. The nearest relative of DNA analysis is protein electrophoresis. However, enzyme variants (isozymes) are orders of magnitude less variable than DNA fingerprints and possess complicating inconsistencies. Different proteins are known to vary their isozyme patterns with age, tissue, sex and sample storage whereas DNA, being the genetic blueprint, is stable.

DNA fingerprinting thus shows a number of advantages as a method for individual identification. Sample collection is relatively unintrusive, identification is both permanent and unambiguous, and subsequent data are produced in an ideal format for a computer data-base to be constructed. Disadvantages may lie in the logistics of sample collection and in the cost of laboratory analysis. Tissue collection necessitates remote sampling including vessel approach to close range and adjusting the orientation of the boat with respect to the subject (see below). This means that there could be problems with catchability, some individuals (or species) being harder to approach than others. The fingerprinting itself will require the support or subcontracting of a molecular biology laboratory. This is likely to be expensive.

METHODS

Sampling

There are various possible alternatives for the collection of tissue samples from free-ranging animals, these include temporary enclosure or capture. We recommend the remote collection of skin biopsies. Sufficient material can be collected by this technique for molecular genetic analyses with minimal intrusion and expense.

The apparatus one of us (ARH) has used to sample killer whales is a 7mm diameter, 20mm long stainless steel core sampler with a 30mm base-plate and three internal, inward facing barbs (see Fig. 1). A 40mm rubber stop covers the base-plate to eliminate the risk of lacerations from the edge and further displace the force of impact. A port below the base-plate allows water and air to escape. The dart is connected to the tip of an arrow and fired from an adjustable compound bow at 25 pounds test. Other researchers have propelled the dart from a rifle (e.g. Winn, Bischoff and Tarushi, 1973), speargun (e.g. Aguilar and Nadal, 1984) or crossbow (e.g. Lambertsen, 1987). The arrow is tethered to a fishing reel mounted at the front of the bow and fitted with a float just behind the dart. In some

cases it may be preferable to use flotation alone to eliminate the chance of the whale becoming entangled in the line. The dart collects about 200–300mg of skin and 500–600mg of blubber. Sample extraction has been facilitated by inward-facing barbs (e.g. Lambertsen, 1987) or a 'butterfly' valve (e.g. Aguilar and Nadal, 1984).

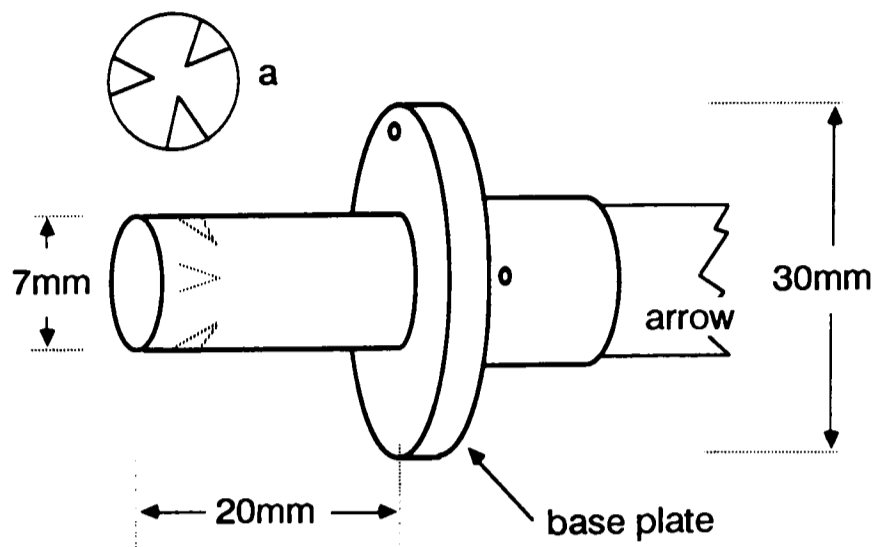

Fig. 1. Biopsy dart. The body of the dart is machined out of steel, with a bevelled cutting edge. Samples are retained by means of the back pointing barbs (see diag. a for end-on view). The dart may be tethered via the hole in the base plate and pressure build up is avoided through inclusion of a vent just behind the base plate.

Collecting samples from a platform at sea requires an approach to within 10–30m of the whale, on a parallel course. Some species are more readily approached at this range than others. For example, it can take considerable time and care to get this close to a minke whale. Furthermore, some individuals or classes of individuals (sex, age) within a species may be more approachable than others. These factors may lead to bias in estimates in the same way that behavioural biases affect photo-identification data (Hammond, 1986). One possible solution would be to use a more powerful projection device for more distant animals.

Recently it has also been found that good quality DNA fingerprints may be obtained from sloughed skin (Amos, Whitehead, Ferrari, Ferrari, Payne and Gordon, 1990). For some species, and under certain circumstances, particularly when there is no doubt as to which individual shed the skin, this could provide a further useful source of material.

Sample preservation

We have tested a number of simple solutions with the aim of developing one capable of preserving DNA samples for periods of months in the absence of cooling (Amos and Hoelzel, 1990). The optimal solution was determined to be a 20% solution of DMSO (dimethylsulphoxide) saturated with table salt (NaCl). The DMSO is thought to act by increasing cellular permeability which allows the preservative, in this case salt, to act faster. After 1 year at an average ambient temperature of 18°C, yields of DNA were found to be 2µg per g of sample (equivalent to approximately 400µg per biopsy) with minimal degradation. Although this is more than sufficient, maximum preservation is achieved with refrigeration. We suggest, therefore, that when facilities are available, samples should be frozen to -20°C as soon as possible. When a preservative is used, we find it preferable to score the skin through to the underlying connective tissue several times with scalpel to maximise surface area.

Laboratory procedures

For the purpose of this paper, DNA fingerprints were prepared from 47 cetacean samples by the following generally applicable procedures. High molecular weight DNA was extracted from 50mg frozen skin samples, powdered in a liquid nitrogen cooled pestle and mortar, or from 2-4ml of whole blood (for *Tursiops truncatus*) collected into EDTA (ethylenediamine-tetracetic acid) vacutainers. Cell lysis was achieved by adding the sample to 0.5ml digestion solution (20mM EDTA, 100mM NaCl, 50mM Tris HCl pH 8.0, 1% SDS (sodium dodecyl sulphate), 200µg/ml Proteinase K) and incubating at 65°C for 2-4hrs. Proteins and other unwanted material were removed by gently extracting first with phenol and then with chloroform (Maniatis, Fritch and Sambrook, 1982). As a further purification, an equal volume of 5M LiCl was added to the aqueous phase, mixed and then incubated at -20°C for 30mins. Under these conditions any remaining protein and organic solvents are precipitated, while the DNA remains in solution. Each sample was then spun at 12,000xg for 5mins to pellet impurities, and the DNA precipitated directly from the supernatant by adding two volumes of 100% ethanol. DNA was pelleted by spinning at 12,000xg for 5mins, washed thoroughly with 70% ethanol, vacuum dried and taken up in 400µl of sterile TE pH 8.0. Using this protocol we normally expect about 100-200µg high molecular weight DNA (>30kb).

For each sample, 2-4µg of DNA were cut with an appropriate restriction enzyme (*Hinf I* for samples in Fig. 2; *Alu I* for samples in Fig. 3) under the conditions specified by the manufacturer. It is important that high quality enzymes are used because genomic DNA is particularly susceptible to incomplete digestion. After digestion, samples were precipitated by adding one tenth volume of 3M sodium acetate pH 5.4, 2.2 volumes of 100% ethanol and incubating for 20mins at -70°C. DNA pellets were recovered by centrifugation, as above, washed

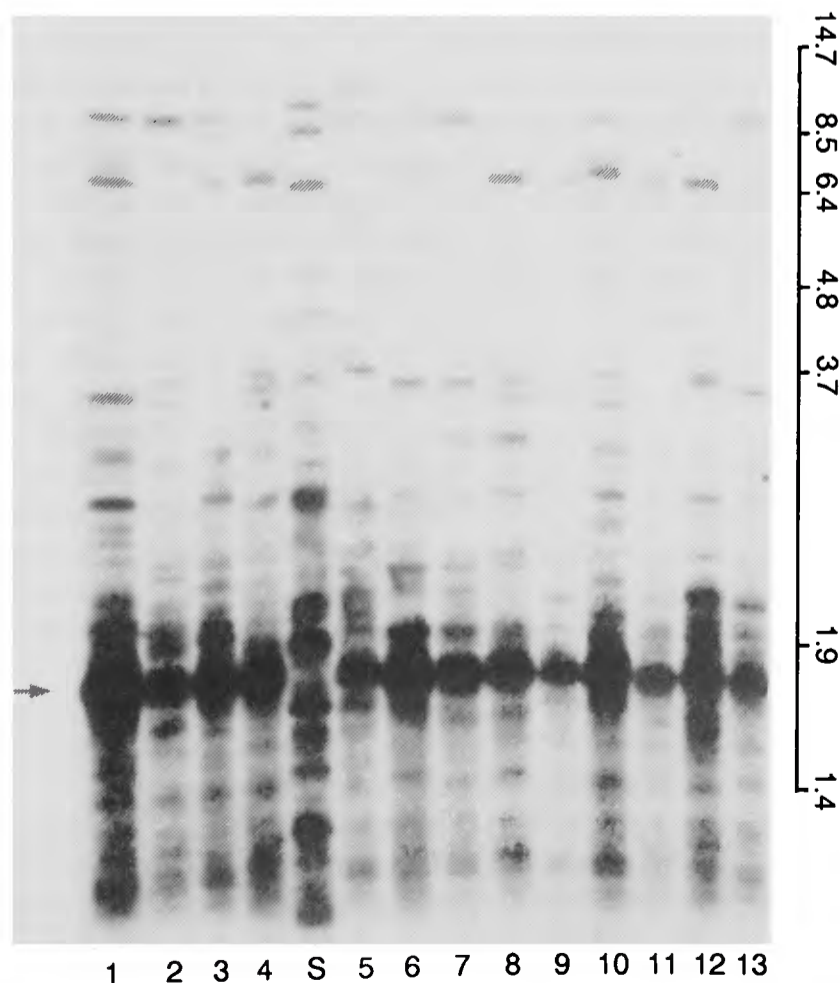

Fig. 2. 13 fin whales and one sei whale (S) digested with *Hinf I* and probed with human polycore probe 33.15.

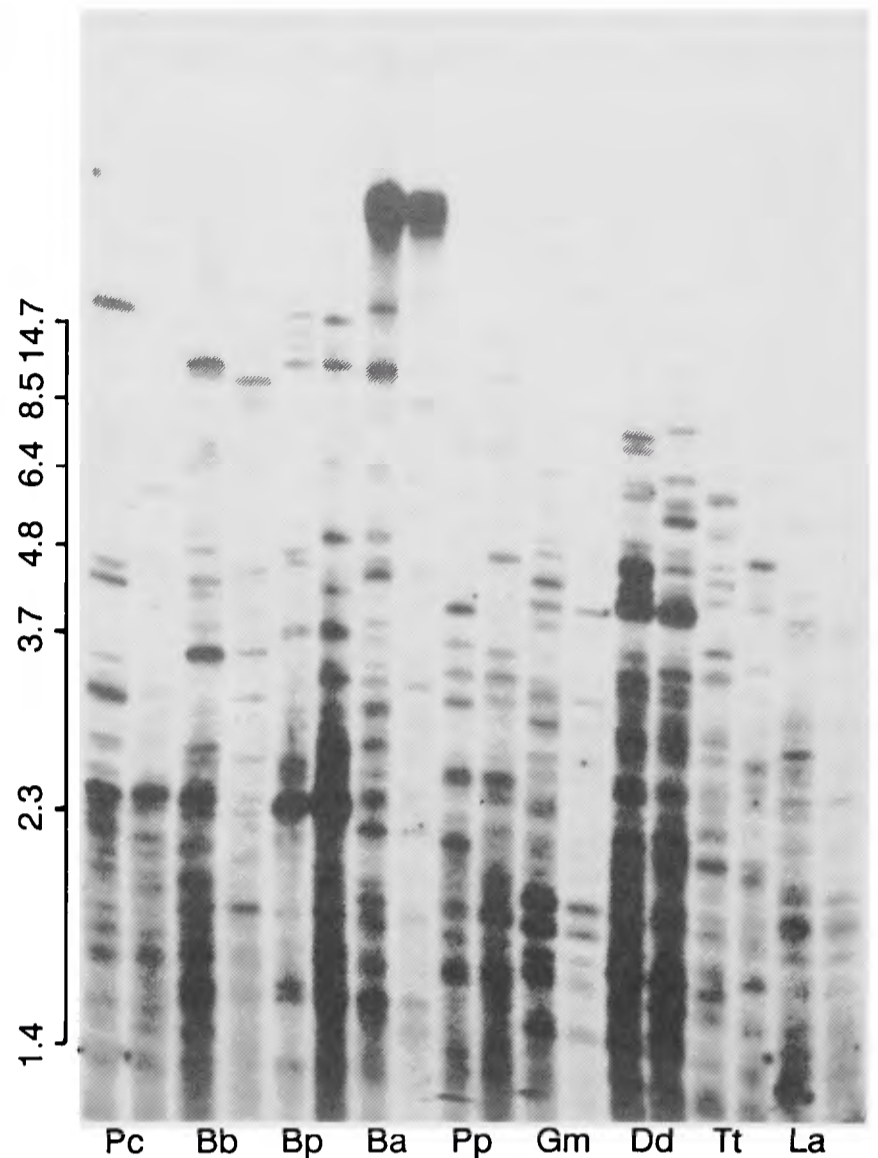

Fig. 3. Nine species of whale cut with *Alu I* and probed with 33.15. Pc - *Physeter catodon*; Bb - *Balaenoptera borealus*; Bp - *B. physalus*; Ba - *B. acuterostrata*; Pp - *Phocoena phocoena*; Gm - *Globicephala melas*; Dd - *Delphinus delphus*; Tt - *Tursiops truncatus*; La - *Laganorhynchus acutus*.

thoroughly with 70% ethanol, vacuum dried and taken up in 15µl of 2:1 TE to Tacon loading buffer (15% ficoll, 0.2% bromophenol blue, 0.5% sodium dodecyl sulphate, 0.25% xylene cyanol, 5mM ethylenediamine tetracetic acid) including approximately 1µg per ml of a suitable marker (in our case bacteriophage lambda DNA cut with the restriction enzyme *Bst EII*).

Samples were then loaded onto a long (350mm) 0.6% agarose gel and electrophoresed for 16-24hrs using TBE buffer (Maniatis *et al.*, 1982). Integral cooling of the gel by a water-based heat exchanger has allowed gels to be run at voltages as high as 175V with a concurrent increase in band resolution (Amos, own data). In the absence of cooling, gels were run at a voltage of 100V.

Following electrophoresis, the gels were stained in a solution of ethidium bromide (1µg/ml) in TBE and photographed using long wavelength ultra-violet light. To aid later transfer of high molecular weight bands, the DNA was depurinated by immersion in 3-4 volumes of 0.25M HCl for 20 mins. The gels were then rinsed with distilled water and 3-4 volumes of denaturation solution added (0.5M NaOH, 1.5M NaCl) before incubating at room temperature for 45mins.

DNA was transferred to a nylon 'Hybond' filter (Amersham) in a modification of the standard southern blotting procedure described in Maniatis *et al.* (1982). The principal modification is that the neutralisation step is omitted and 0.25M NaOH, 1.5M NaCl is substituted as the DNA transfer medium. Blotting was carried out for 2-10

hours, the filter was then washed in 2XSSC and the DNA covalently bound to the filter by baking at 80°C for one hour.

Hybridisation:Hybond filters were prehybridised in a solution containing 1XSSC, 5% PEG (polyethyleneglycol 6000), 0.5% SDS, 50µg/ml heparin and 5µg/ml wheat tRNA for 45mins. at 62°C. The radioactive probe was prepared by a standard primer extension sequencing reaction performed on single stranded M13 DNA containing the human polycore insert 33.15. We use the 'Sequenase' enzyme (*United States Biochemical*) employed under conditions specified by the manufacturer, to incorporate $\alpha^{32}\text{P}$ labelled dATP. For maximum sensitivity, the labelled insert band was isolated on a 1% low melting point agarose gel. To use the probe, the agarose slice was melted and added directly to the prehybridisation solution. Hybridisation was allowed to proceed for 8–10 hours at 62°C with gentle agitation. Filters were rinsed briefly in 2XSSC and then more stringently under identical conditions to the hybridisation, in this case 1XSSC, 0.5% SDS at 62°C. They were allowed to air-dry, wrapped in plastic film and exposed to autoradiography film with intensifying screens at -70°C for 1–3 days.

Analysis

DNA fingerprints, at their simplest level, comprise ladders of bands visualised on autoradiography film. In order for successful capture-recapture programmes to employ DNA fingerprinting it is clearly necessary for all the information encoded in these bands to be comparable between experiments and to exist in such a form that a useful database may be constructed. To facilitate comparisons this database should be readily accessed and processed by computer.

There are two major sources of inconsistencies that may hamper analysis: the characteristics of the gel which determine the differential band migrations and the precise conditions employed to detect the bands by radioactive probe hybridisation.

Of these two, the former is the most readily standardised. It has been empirically determined that the molecular weight of any given fragment is approximately inversely proportional to the log of the distance it migrates, over a broad range of DNA fragment sizes. Within the range of 1Kb to 8Kb, this relationship holds very well. Above 8Kb the relationship gets progressively worse. Fortunately most of the fragments that make up the readable portion of a DNA fingerprint lie within the range for which the approximation is close. Those that lie outside will be discussed later.

Since the graph of log migration distance against molecular weight is a straight line, it may be described by the generalised equation

$$y = mx + c$$

where m is the gradient and c is the intercept on the y -axis. For any gel, m and c may be determined by regression analysis performed on molecular weight standards run in parallel. Algebraic interpolation will now convert the measured migration distances of individual fingerprint bands into molecular weights.

Unfortunately, the parameters m and c vary with experimental conditions, particularly the distance run and the concentration of agarose in the gel. Not only can there be significant effects between gels, but also there may be

effects across any particular gel. Thus, for greatest accuracy, we now load marker fragments in every experimental lane, as described above.

After autoradiography, banding patterns are read using a sonic pen and digitiser, and migration distances are stored directly into computer files. We input all data three times and then calculate the average (estimated accuracy $\pm 0.1\text{mm}$) for the best mobility estimate in order to reduce inaccuracies. Nylon membranes are used in preference to the more traditional nitrocellulose since they are considerably more amenable to multiple probings. Each filter may thus be rehybridised to a radioactively labelled probe for the marker, generating marker bands in every lane. These bands are digitised as before. A simple regression formula may be used to calculate the graph gradient and intersect for each lane. These in turn may be applied to interpolate molecular weights from all the digitised fingerprint band migration distances. Using this method an 18 lane gel can be read in under 1 hour. The end product is a list of molecular weights for every individual which are directly comparable between gels and labs. Work already conducted by one of us (WA) surveying a population of grey seals has shown that error levels on molecular weight estimates are as low as ± 0.2 – 0.5% of the actual size. Further refinements will come when the confidence limits on these molecular weight estimates are better quantified.

Returning to the problem of bands of high molecular weight, if the migration distances of fragments of known molecular weights are plotted, it is clear that above 8–10kb the graph becomes progressively less linear. This problem may be overcome in more than one way.

The simplest solution is to compare bands in this range by eye. Since bands become increasingly rare in this size class they are usually easy to classify. Estimates of molecular weights become little more than a guess. Despite this, assignment of particular bands to an individual is generally very accurate. Current work on grey seals suggest that this method can allow the reliable classification of a large number of individuals.

A more rigorous solution is to construct a marker with additional high molecular weight bands to cover this region. With this extra information a line may be fitted over the entire experimental range. However, a linear regression is no longer adequate. Instead a polynomial can be used. When plotted on a log:log scale, the data are distinctly sigmoid, so a third order equation was selected. The correlation coefficient of such a fitted curve is extremely good. Using this method, the reliability of molecular weight estimates above 10kb was greatly enhanced, as judged by the measurement of identical bands on different gels. Directly comparable molecular weight estimates should thus be possible for all fragments. There is, however, one major drawback. A fitted polynomial will only give accurate results for gels that have run evenly. When anomalies are present it might be preferable to revert to interpolating molecular weights from immediately adjacent marker bands using a log:normal plot and a standard regression formula.

The second problem, that of variability in band detection during hybridisation, is more difficult to overcome. A fingerprint comprises a spectrum of bands detected by a radioactively labelled consensus sequence. Matching is seldom absolute. Not only will the probe 'stick' to identical sequences but also to many sequences showing only partial homology. There thus exists a complete continuum of

detection over related sequences of DNA. Sequences that match the probe completely are detected under all conditions but imperfect matches stand an increasingly greater chance of passing undetected as experimental conditions become more stringent. The precise threshold which governs where on the continuum bands cease to be detected is determined by the exact conditions under which hybridisation of the probe to the target DNA is carried out. Despite rigorous standardisation of protocols, small changes in salt concentration or temperature can still cause this threshold to shift slightly, leading to the gain or loss of bands. Such effects clearly complicate the subsequent fingerprint analysis.

This problem may be approached in several ways. First, however, it must be emphasised that it is only a small proportion of bands that lie near enough to the threshold to be affected (about 6% in humans; Jeffreys *et al.*, 1985b). One approach is simply to ignore very faint bands or those that are difficult to interpret when repeat samplings are run under standardised conditions. A more positive step, which we are investigating, is the inclusion of some form of marker DNA with a full range of band intensities so that the precise hybridisation conditions can be monitored directly. This could be constructed as a mixture of genomic DNA from two or more individuals with particularly different fingerprints, and for which large quantities of DNA are available.

RESULTS

Ten cetacean species (three mysticetes and seven odontocetes) were studied. All show patterns of variable bands when probed with the human minisatellite probe 33.15 (Jeffreys *et al.*, 1985a). The results are presented in Figs 2 and 3. One species (the fin whale, *Balaenoptera physalus*) is represented by 13 individuals (Fig. 2). Its banding pattern illustrates what seems to be a common trend for cetaceans; the distribution of band frequencies across the sample of individuals is roughly polynomial with most bands being relatively rare and a few very common. It also appears that some low molecular weight bands may be characteristic of a species. This possibility is illustrated in Fig. 2 where one sei whale (*B. borealis*) is included after fin whale number 4. The bands below the arrow at the left of the figure are clearly distinct between these two congeners. A similar pattern of consistent band differences can be seen for populations of minke whales, *B. acutorostrata* (Amos and Dover, 1990). Jeffreys *et al.* (1985b) also report a higher probability of bandsharing for smaller minisatellite fragments in humans.

If it is assumed that all co-migrating bands are identical alleles from the same minisatellite locus, the probability x that a fragment in individual A is present in individual B is related to the allele frequency q by $x = 2q - q^2$. Because some unknown (but presumably small) proportion of co-migrating bands will be derived by chance from different loci, this estimation of x is maximal. Jeffreys *et al.* (1985b) show that x varies from 0.08 at 10–20Kb to 0.27 at 4–6Kb in human DNA probed with fragment 33.15.

The 13 fin whales presented in Fig. 2 were compared for bandsharing between all individuals for 50 discernible bands from 1.5–15Kb (Table 1). Data were grouped by molecular weight because different size classes vary considerably, both for the number of bands observed and for the average variability of each band. The distribution of band occurrence frequencies is shown in Fig. 4. The mean

Table 1

DNA fragment number	Fragment size (kb)	No. of fragments/individual \pm SD	\bar{x}
1-10	7-15	2.5 \pm 1.3	0.37
10-20	3-7	2.8 \pm 1.2	0.46
20-30	2-3	3.7 \pm 1.3	0.57
30-40	1.8-2.0	3.5 \pm 1.1	0.52
40-50	1.5-1.8	3.3 \pm 1.9	0.53

probability that all fragments in an individual A are present in individual B is $0.37^{2.5} \times 0.46^{2.8} \times 0.57^{3.7} \times 0.52^{3.5} \times 0.53^{3.3} = 1.5 \times 10^{-5}$ (the multiplication of x to the power of the mean number of bands for each category, see Table 1). This is considerably greater than the same probability determined for humans (3×10^{-11}) using the same computations for bands within the range 4–20kb (Jeffreys *et al.*, 1985b). It is however, a minimal estimate for the discriminatory power of this technique, as the probability that A and B are identical (that B does not possess any additional 1.5–15kb fragments) is $< 1.5 \times 10^{-5}$. Further, a larger sample may detect more bands at lower frequencies. The use of additional probes such as 33.6 (Jeffreys *et al.*, 1985a) or M13 (Vassart *et al.*, 1987) will also reduce this probability. For humans the use of the additional probe 33.6 reduced the probability from 3×10^{-11} to 5×10^{-19} . This estimation also assumes that the individuals compared are non-relatives from a large random mating population in Hardy-Weinberg equilibrium. It is not known if these conditions hold for this sample. If not, the probability estimate will be too high.

The discriminatory power of DNA fingerprinting depends primarily on the frequency of individual fragments and the average number of variable fragments. An approximation to the probability of all bands from individual A being present in individual B can be made by comparing the allele frequency (q) averaged over all bands to the mean number of detectable variable bands. This relationship is illustrated in Fig. 5. The larger the number of rare fragments, the greater the discriminatory power. Note that above $q=0.5$, increasing the number of bands does little to improve the resolution of the technique. For the fin whale sample, average q was 0.32. All species represented in Fig. 3 show substantial variation between individuals and an average number of variable bands from 20–40. This suggests that the technique is applicable to these species as well, although a more rigorous preliminary assessment would be recommended for an intended study species.

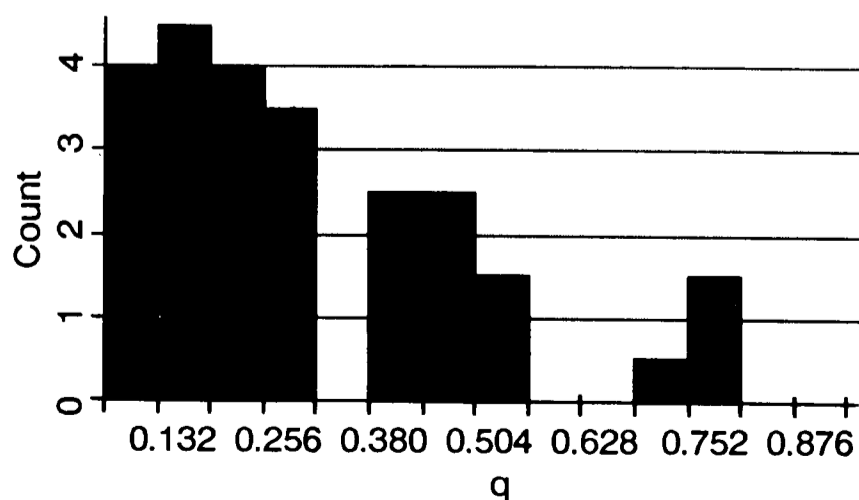

Fig. 4. Distribution of allele frequencies for 50 discernible bands in 13 fin whale samples.

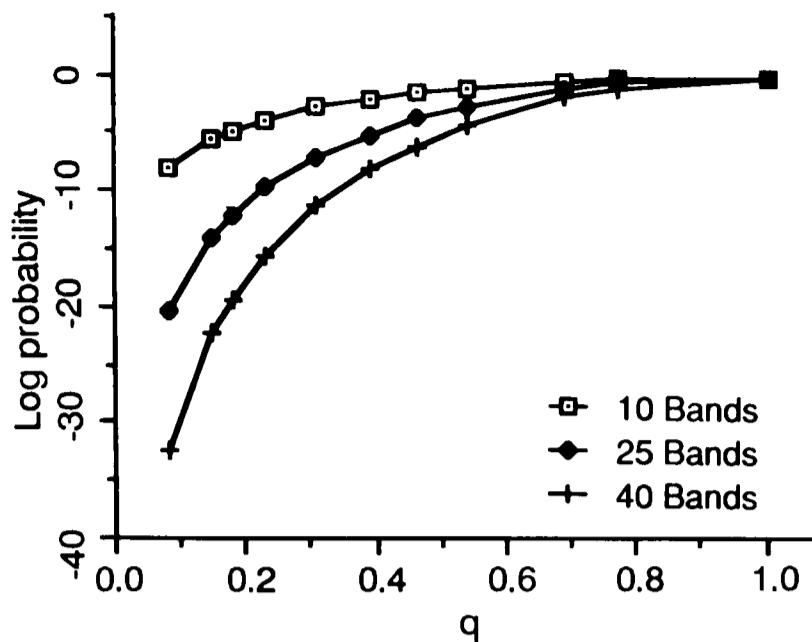

Fig. 5. Relationship between the mean allele frequency for a distribution of mini-satellite fragments (q) and the probability that all the bands represented in individual A will be present in individual B; given for 3 different values of mean number of variable bands (10, 25 and 40).

DISCUSSION

Although preliminary, these results show that DNA fingerprinting has the potential to differentiate all individuals in the current estimated world stock of fin whales. The logistics of a population survey are less clear. Various researchers have demonstrated the feasibility of biopsy sampling (e.g. Winn *et al.*, 1973; Lambertsen, 1987; Mathews *et al.*, 1988). The resulting tissue yields DNA that is both of adequate quality and sufficient quantity for DNA fingerprinting analysis (Hoelzel and Amos, 1988).

In comparison with other available techniques it is seen that all have both advantages and disadvantages. Photo-identification has the principle benefit of being minimally intrusive, an important consideration when analysing behaviour patterns. Individuals of certain species such as humpback whales (Katona, Baxter, Brazier, Kraus, Perkins and Whitehead, 1979), killer whales (Bigg, 1982) and right whales (Payne, Brazier, Dorsey, Perkins, Rowntree and Titus, 1983), can be readily identified from permanent markings but in other species, acquired characters such as scarring patterns must be updated regularly as new scars are acquired and old ones fade (e.g. minke whales – Dorsey, Stern, Hoelzel and Jacobson, 1990). In addition, individual photographs can vary enormously in their image quality and information content and behavioural biases can affect the 'catchability' of individuals or sub-classes within the population (see Hammond, 1986). For example, female humpbacks with calves appear to present their flukes less readily than males (Perkins *et al.*, 1985). A model has been devised to compensate for this effect (Rice *et al.* 1987).

In contrast to photo-identification, artificial tags provide unambiguous identification. However, the process of attachment is unavoidably intrusive, may cause mortality and may alter subsequent behaviour (and thus the likelihood of recapture). In addition, tags may be lost at an unknown rate (e.g. Buckland and Duff, 1989).

DNA fingerprinting provides both permanence and unambiguous identity. Biopsy darts are less intrusive than most artificial tags but they will always be more intrusive than photo-identification. Of course, all these methods will

suffer from general problems of applying mark-recapture techniques (see Seber, 1982; Hammond, 1986; Buckland and Duff, 1989).

In surveys involving potentially large numbers of samples it is important to incorporate computerised data-processing. DNA fingerprinting is an ideal technique for this. Results are essentially expressed in bar code notation with the potential for a binary representation of the presence or absence of bands. Computer-based interpretation of photographic data can be considerably more complex (e.g. those requiring transformational morphologies and image matching), and the simplest applications are necessarily more subjective (e.g. inputting data visually interpreted from photographs). Hiby and Lovell (1990), Mizroch, Beard and Lynde (1990) and Whitehead (1990) describe three such systems.

Finally, for any technique there must be a balance between the cost of research and the expected results. It is clear that work involving DNA analysis is both more difficult to perform and more expensive than an equivalent study relying on photographic identification. The present commercial price of DNA fingerprinting is £100 sterling per sample (*Cellmark Diagnostics*). This is a maximum price and would be comparable to one individual post-doctoral worker working in an English laboratory for one year and processing 300 samples. However, samples processed by an established laboratory which already had the technique working well could probably process upwards of 1,000 samples per year per person. This would work out at roughly £30 per sample. Furthermore, the enormous potential of DNA fingerprinting is attracting intense research interest all around the world. This will undoubtedly result in the refining of methodologies, the simplification of protocols and the general streamlining of sample processing. It is expected that this will result in both greater reliability and lower cost per sample.

In conclusion, DNA fingerprinting offers an interesting alternative to both photo-identification and artificial tagging for capture-recapture and other research programmes. The technique is relatively unintrusive, permanent, has adequate discriminatory power and produces data in ideal format for computer data-bases. However, at present, it may be financially practical only for population censuses of those species that are difficult to 'capture' photographically.

ACKNOWLEDGEMENTS

We wish to thank John Barrett, John Harwood, Greg Donovan and two anonymous reviewers for their helpful comments on the manuscript. We also thank Tasmin Majerus for technical assistance. Fin whale samples were provided by Christina Lockyer and Tim Waters. Amos was supported by a Natural Environment Research Council Fellowship.

REFERENCES

- Aguilar, A. and Nadal, J. 1984. Obtencion de biopsias hipodermicas de cetaceos en libertad. *Invest. Pesquera* 48(1):23-9.
- Amos, W., Barrett, J.A. and Dover, G.A. In prep. Breeding behaviour of pilot whales revealed by DNA fingerprinting.
- Amos, W. and Dover, G.A. 1990. The use of satellite DNA sequences in determining population differentiation in the minke whales. *Rep. int. Whal. Commn* (special issue 13).
- Amos, W. and Hoelzel, A.R. 1990. Preservation of cetacean tissue for molecular analysis. *Rep. int. Whal. Commn* (special issue 13).

- Amos, W., Whitehead, H., Ferrari, M., Ferrari, D., Payne, R. and Gordon, J.C.D. 1990. Sloughed cetacean skin for use in DNA fingerprinting. *Mar. Mammal Sci.* (in press).
- Arnason, U., Bellamy, H., Eyporrson, P., Lutley, R., Sigurjónsson, J. and Widegren, B. 1985. Conventionally stained and c-banded karyotypes of a female blue whale. *Hereditas* 102:251-3.
- Bigg, M.A. 1982. An assessment of killer whale (*Orcinus orca*) stocks off Vancouver Island, British Columbia. *Rep. int. Whal. Commn* 32:655-66.
- Buckland, S.T. and Duff, E.I. 1989. Analysis of Southern Hemisphere minke whale mark-recapture data. *Rep. int. Whal. Commn* (special issue 11):121-43.
- Burke, T. and Bruford, M.W. 1987. DNA fingerprinting in birds. *Nature, Lond.* 327:149-52.
- Chandley, A.C. and Mitchell, A.R. 1988. Hypervariable minisatellite regions are sites for crossing-over at meiosis in man. *Cytogen. Cell Gen.* 48:152-155.
- Dallas, J.F. 1988. Detection of DNA 'fingerprints' of cultivated rice by hybridization with human minisatellite DNA probe. *Proc. NAS (U.S.)* 85:6831-5.
- Dorsey, E.M., Stern, S.J., Hoelzel, A.R. and Jacobsen, J. 1990. Minke whales, *Balaenoptera acutorostrata*, from the west coast of North America: individual recognition and small-scale site fidelity. Paper SC/A88/ID21 (published in this volume).
- Elliot, R.W. 1986. A mouse 'minisatellite'. *Mouse News Letter* 74:115-17.
- Georges, M., Cochaux, P., Lequarre, A.S., Young, M.W. and Vassart, G. 1987. DNA fingerprinting in man using a mouse probe related to part of the *Drosophila* 'Per' gene. *Nucleic Acids Res.* 15:7193.
- Gill, P., Jeffreys, A.J. and Werrett, D.J. 1985. Forensic applications of DNA fingerprints. *Nature, Lond.* 318:577-9.
- Hammond, P.S. 1986. Estimating the size of naturally marked whale populations using capture-recapture techniques. *Rep. int. Whal. Commn* (special issue 8):253-82.
- Hiby, L. and Lovell, P. 1990. Computer-aided matching of natural markings: a prototype system for grey seals. Paper SC/A88/ID9 (published in this volume).
- Hoelzel, A.R. and Dover, G.A. 1989. Molecular techniques for examining genetic variation and stock identity in cetacean species. *Rep. int. Whal. Commn* (special issue 11):81-120.
- Hoelzel, A.R. and Amos, W. 1988. DNA fingerprinting and 'scientific' whaling. *Nature, Lond.* 333:305.
- International Whaling Commission. 1990. Report of the Workshop on individual recognition and the estimation of cetacean population parameters (published in this volume).
- Jeffreys, A.J., Brookfield, J.F.Y. and Semeonoff, R. 1985. Positive identification of an immigration test-case using human DNA fingerprints. *Nature, Lond.* 317:818-9.
- Jeffreys, A.J. and Morton D.B. 1987. DNA fingerprints of dogs and cats. *Anim. Gen.* 18:1-15.
- Jeffreys, A.J., Royle, N.J., Wilson, V. and Wong, Z. 1988. Spontaneous mutation rates to new length alleles at tandem - repetitive hypervariable loci in human DNA. *Nature, Lond.* 332:278-81.
- Jeffreys, A.J., Wilson, V., Kelly R., Taylor, B.A. and Bulfield, G. 1987. Mouse DNA 'fingerprints': analysis of chromosome localisation and germ-line stability of hypervariable loci in recombinant inbred strains. *Nucleic Acids Res.* 15:2823-6.
- Jeffreys, A.J., Wilson, V. and Thein, S.L. 1985a. Hypervariable 'minisatellite' regions in human DNA. *Nature, Lond.* 314:67-73.
- Jeffreys, A.J., Wilson, V. and Thein, S.L. 1985b. Individual specific 'fingerprints' of human DNA. *Nature, Lond.* 316:76-9.
- Jeffreys, A.J., Wilson, V., Thein, S.L., Weatherall, D.J. and Ponder, B.A.J. 1986. DNA 'fingerprints' and segregation analysis of multiple markers in human pedigrees. *Am. J. Hum. Genet.* 39:11-24.
- Katona, S., Baxter, B., Brazier, O., Kraus, S., Perkins, J. and Whitehead, H. 1979. Identification of humpback whales by fluke photographs. pp.33-34. In: H.E. Winn and B.L. Olla (Eds.), *Behavior of Marine Animals, Vol. 3: Cetaceans*. Plenum Press, N.Y.
- Lambertsen, R.H. 1987. A biopsy system for large whales and its use in cryogenetics. *J. Mammal.* 68:443-5.
- Maniatis, T., Fritsch, E.F. and Sambrook, J. 1982. *Molecular Cloning: a Laboratory Manual*. Cold Spring Harbour Laboratory, N.Y. i-x + 545pp.
- Mathews, E.M., Keller, S. and Weiner, D.B. 1988. A method to collect and process skin biopsies for cell culture from free-ranging grey whales (*Eschrichtius robustus*). *Mar. Mamm. Sci.* 4(1):1-12.
- Mizroch, S.A., Beard, J. and Lynde, M. 1990. Computer assisted photo-identification of humpback whales. Paper SC/A88/ID11 (published in this volume).
- Morton, D.B., Yaxley, R.E., Patel, I., Jeffreys, A.J., Howes, S.J. and Debenham, P.G. 1987. Use of DNA fingerprint analysis in identification of the sire. *Vet. Rec.* 121:592-4.
- Payne, R., Brazier, O., Dorsey, E.M., Perkins, J., Rowntree, V. and Titus, A. 1983. External features in southern right whales (*Eubalaena australis*) and their use in identifying individuals. pp. 371-45. In: R. Payne (ed.) *Communication and Behavior of Whales* AAS Selected Symposium Series 76. Westview Press, Boulder, Colorado. 643pp.
- Perkins, J.S., Balcomb, K.C. III, Nichols, G. Jr., Tilghman Hall, A., Smultea, M. and Thumser, N. 1985. Status of the West Germany humpback whale feeding aggregation, 1981-83. *Rep. int. Whal. Commn* 35:379-83.
- Rice, M., Carlson, C., Chu, K., Dolphin, W. and Whitehead, H. 1987. Are humpback population estimates being biased by sexual differences in behaviour? *Rep. int. Whal. Commn* 37:333-5.
- Ryskov, A.P., Jincharadze, A.G., Prosnjak, M.I., Ivanov, P.L. and Limborskaya, S.A. 1988. M13 phase DNA as a universal marker for DNA fingerprinting of animals, plants and microorganisms. *FEBS Letters* 233:388-392.
- Ryskov, A.P., Tokarskaya, O.N., Verbovaya, L.V., Jincharadze, A.G., Ginzburg, A.L., Zigangirova, N.A., Shubin, F.N. and Smirnov, G.B. 1988. DNA fingerprinting in microorganisms: The use of M13 DNA as a hybridization probe. *Genetika* 24:1310-1313 [In Russian].
- Schafer, R., Zischler, H. and Epplen, J.T. 1988. (CAC)₅, a very informative oligonucleotide probe for DNA fingerprinting. *Nucleic Acids Res.* 16:5196.
- Seber, G.A.F. 1982. *The Estimates of Animal Abundance and Related Parameters*. 2nd Edn. Griffin, London. 654pp.
- Vassart, G., Georges, M., Monsieur, R., Brocas, H., Lequarre, A.S. and Christophe, D. 1987. A sequence of M13 phase detects hypervariable minisatellites in human and animal DNA. *Science* 235:683-4.
- Wetton, J.H., Carter, R.E., Parkin, D.T. and Walters, D. 1987. Demographic studies of a wild house sparrow population by DNA fingerprinting. *Nature, Lond.* 327:147-9.
- Whitehead, H. 1990. Fast computer-assisted individual identification of sperm whale flukes. Paper SC/A88/ID42 (published in this volume).
- Winn, H.E., Bischoff, W.L. and Tarushi, A.G. 1973. Cytological sexing of cetacea. *Mar. Biol.* 23:343-6.
- Wong, Z., Wilson, V., Jeffreys, A.J. and Thein, S.L. 1986. Cloning a selected fragment from a human DNA 'fingerprinting': isolation of an extremely polymorphic minisatellite. *Nucleic Acid Res.* 14:4605-16.

Non-Metrical Analyses of Pelage Patterns in Demographic Studies of Harbor Seals

P.K. Yochem¹, B.S. Stewart¹, M. Mina², A. Zorin³, V. Sadovov³, and A. Yablokov²

ABSTRACT

Phenotypic variation in pelage patterns of North Pacific harbor seals has been observed and described by several researchers. We developed a classification scheme of non-metrical pelage characters (e.g. presence or absence of spots in various body areas) and tested intra- and inter-observer variability in scoring black-and-white photographs of harbor and largha seals. Observer agreement was good overall, but some observers disagreed when scoring the more subjective characters (e.g. spot density). We also compared pelage patterns of harbor seals from San Miguel, Santa Rosa and San Nicolas islands and found inter-island differences in two characters.

INTRODUCTION

The taxonomy of *Phoca vitulina* (*sensu lato*) in the North Pacific Ocean and Bering Sea has been controversial, although most recent authors have agreed about the existence of several forms or ecotypes (e.g. Belkin 1964; Burns, Fay and Fedoseev, 1984; McLaren, 1966; Naito and Nishiwaki, 1975; Shaughnessy and Fay, 1977). The controversy concerns the relationship of *Phoca largha* (the principally ice-associated 'largha' or 'spotted' seal of the Bering Sea) and *Phoca vitulina* (coastal forms of harbor seal of the eastern and western Pacific and the Aleutian Islands). Shaughnessy and Fay (1977) and Burns *et al.* (1984) concluded that the observed geographic variation in phenotypes (pelage pattern – Burns and Gol'tsev, 1984; Kelly, 1981; Shaughnessy and Fay 1977; cranial morphology – Burns *et al.* 1984; Fedoseev, 1984) and parasite faunas (Delyamure *et al.*, 1984; Shults, 1982) supported the taxonomic distinction, as sibling species, of *P. largha* and *P. vitulina*.

The specific distinction of *P. largha* from *P. vitulina* is not universally accepted, however, particularly among many Soviet scientists who treat the largha seal as a subspecies of *P. vitulina*. Further, introgression between eastern Pacific and western Pacific forms of *P. vitulina* along the Aleutian-Commander Ridge creates problems in distinguishing the proposed subspecies (*richardsi* and *stejnegeri* [= *kurilensis* = *insularis*]) and a boundary between them has not yet been unambiguously determined (e.g. Burns and Gol'tsev, 1984).

Nevertheless, pending a more comprehensive treatment, we operationally adopt here the most recent taxonomic division: *P. largha* = the ice-associated 'largha' or 'spotted' seal of the Bering Sea; *P.v. richardsi* = coastal harbor seal of the eastern Pacific; and *P.v. stejnegeri* = coastal harbor seal of the western Pacific (Burns *et al.*, 1984, Shaughnessy and Fay, 1977).

The pelage patterns of *P. largha* and *P. vitulina* are phenotypically variable and, although the patterns themselves are extremely complex, previous studies (e.g. Shaughnessy and Fay, 1977; Kelly, 1981) suggest that frequencies of various phenotypes vary geographically and

may be useful in examining the extent of genetic exchange among local colonies or populations or between sympatric forms (e.g. *P.v. richardsi* and *P.v. stejnegeri* at the Aleutian Islands). As the largha seal is regularly hunted along the eastern Soviet coast of the Bering Sea, skeletal and organ samples are available for demographic analyses. However, *P.v. stejnegeri* is evidently not common, particularly along the Asian coast, and *P.v. richardsi* is protected by US law (US Marine Mammal Protection Act, 1972) from commercial harvest, non-native subsistence killing and harassment; thus few comparative demographic samples are available for those forms. As it has not been practical (or feasible in most areas) to establish sufficiently large samples of tagged cohorts in local populations, other non-lethal methods are needed to permit comparative demographic and phenotypic studies.

We had two primary objectives in developing a simple method of reliably discriminating various non-metrical characters of pelage patterns of harbor seals: (1) the scheme should permit reproducible inter-colony and inter-population comparisons of individual, or sets of, characters; i.e. there should be little intra- or inter-observer variability in classifying the patterns of individual seals; and (2) the scheme should serve as a primary sorting step in uniquely identifying individual seals for demographic studies.

Non-metrical analyses of cranial characters have been used to discriminate populations of several species (e.g. Berry, 1969; 1974; Berry and Berry, 1967; 1972; Burns *et al.*, 1984; Burns and Goltsev, 1984; Fedoseev, 1984; Kinze, 1985). This method assumes that the incidence of phenotypes is genetically rather than environmentally controlled (Berry, 1974). Mammalian coat patterns are genetically determined (e.g. Aldensteinsson, 1970; 1974; Gill, 1976; Searle, 1968), although the mechanisms that create those patterns are poorly understood (Searle, 1968; Murray, 1981a; 1981b). Murray and Maini (1986) and Murray (1988) have recently proposed that a single pattern-formation (diffusion-reaction) model may explain most, if not all, of the observed patterns.

METHODS

Between April 1984 and October 1988, we collected and analysed photographs of harbor seal pelage patterns from the Southern California Channel Islands and the Asian Coast and of largha seals from the western Bering Sea. We

¹ Sea World Research Institute, Hubbs Marine Research Center, 1700 South Shores Road, San Diego, California, 92109, USA

² N.K. Koltzoff Institute of Developmental Biology, USSR Academy of Sciences, 26 Vavilov Str., Moscow W-334, 117808, USSR

³ VNIRO, 17, V. Krasnoselskaya, Moscow, B-140, 107140, USSR

photographed harbor seals on rookeries and hauling grounds on the Southern California Channel Islands using a hand-held or tripod-mounted 35mm camera attached to a *Celestron* C-90 spotting scope or a 600mm lens; black-and-white film (ASA 125 and ASA 400) was used. We photographed skins of harbor and largha seals at the Zoological Institute of the Academy of Sciences in Leningrad (USSR) with a hand-held 35mm camera, 28–80mm zoom lens and black-and-white film (400 ASA). Additional black-and-white photographs of largha skins from the western Bering Sea were made available to us by researchers at VNIRO (Moscow, USSR).

Preliminary studies on captive seals (Sea World Inc., San Diego) and on wild, uniquely-tagged, seals (Yochem and Stewart, unpublished data) suggest that pelage patterns are stable through juvenile and adult stages. However, because ontogenetic changes in colour patterns are known for ribbon seals (Tikhomirov, 1966) and some dolphins (Perrin, 1970; 1972) we conservatively used only photographs of adults. From those photographs and our observations of wild seals, we developed a scheme to classify pelage patterns using twelve characters in each of eight body areas (e.g. face, chest and neck, foreflipper). Four or five observers then independently scored each character from black-and-white enlargements of photographs of 59 seals from San Nicolas Island and 95 seals from San Miguel Island. Characters were retained or eliminated from the classification scheme depending on the analyses of intra- and inter-observer variability in scoring those characters. We then tested the revised scheme on a subset of photographs (lateral view) of seals from San Nicolas ($n=20$), San Miguel ($n=14$), and Santa Rosa ($n=34$) islands.

We used a Wilcoxon paired-sample test (Zar, 1984) to test the null hypothesis that replicate scorings of characters by each observer did not differ (i.e. intra-observer variability). We used a Kruskal-Wallis one way ANOVA by ranks (Zar, 1984) to test the following null hypotheses: (1) that scores for each character did not differ significantly among observers (i.e. inter-observer variability); and (2) that there were no differences among islands for each character.

After sorting seals into general categories (Fig. 1) based on character scores, we identified individual seals from unique minor spot or ring patterns, primarily on the sides



Fig. 1. The adult harbor seal (bottom) illustrates one of several major categories of pelage pattern used in this study: both spots and rings present, with spots present in all body areas (e.g. face, foreflipper, chest and neck).

of the head, neck and chest and used secondary and tertiary marks to confirm the identity of resighted (re-photographed) seals.

RESULTS AND DISCUSSION

In our preliminary investigations we found that lateral or near-lateral photographs of newly moulted animals were the least ambiguous for analysing patterns of live seals. In many cases photographs of wet seals that had not yet moulted were also acceptable depending on the extent of surface glare. As not all body areas are visible in lateral views we modified our preliminary classification scheme to include only six characters (arranged dichotomously) of the dorsal and ventrolateral body surface (presence of spots, clarity of spots, relative density of spots, complexity of spots, presence of rings, spacing of rings). Thus, each character could be evaluated independently but the assemblage of character scores uniquely identified a seal as a particular pelage type.

Observers' replicate scorings of each character did not differ significantly except for estimates of spot density by two observers (Table 1). These two observers participated in the last series of classifications only, and therefore were the least familiar with the reference photographs used to define character state values.

Table 1

Reproducibility of observer scorings of harbor seal pelage pattern characters (z =test statistic for Wilcoxon paired-sample test, p =significance level, n =sample sizes).

Observer:-	1		2		3		4	
	z	p	z	p	z	p	z	p
<i>Spots - presence</i>								
	0.000	1.000	1.040	0.300	-0.492	0.620	0.329	0.742
n_1	67		47		68		67	
n_2	67		56		64		66	
<i>Spots - clarity</i>								
	0.902	0.367	-1.633	0.102	-0.022	0.823	-0.390	0.690
n_1	37		22		38		37	
n_2	37		33		33		35	
<i>Spots - type</i>								
	0.243	0.808	0.265	0.791	-0.080	0.936	0.618	0.536
n_1	37		22		38		37	
n_2	37		33		33		35	
<i>Spots - density</i>								
	-0.665	0.505	-2.290	0.022	3.351	0.001	0.309	0.760
n_1	37		22		38		37	
n_2	37		33		33		35	
<i>Rings - presence</i>								
	0.000	1.000	-0.111	0.912	-0.940	0.350	-0.430	0.670
n_1	67		47		68		67	
n_2	67		56		64		66	
<i>Rings - spacing</i>								
	0.280	0.780	-1.130	0.190	0.330	0.740	-0.580	0.560
n_1	67		47		68		67	
n_2	67		56		64		66	

We found no differences among observers in scoring three characters (presence of spots in each field, clarity of spots and presence of rings) but the scorings did differ among observers for spot type ($p<0.01$), spot density ($p<0.05$) and spacing of rings ($p<0.04$), primarily due to variability in scoring seals from Santa Rosa Island ($P_{\text{rings}} = 0.002$) or San Miguel Island ($P_{\text{density}} = 0.049$). Since our scheme assigns discrete values to continuously varying

characters, the need for unambiguous character value references (i.e. reference photographs) is emphasised by this exercise. Assessment of density and spacing (characters whose scores varied significantly among some observers) are of course more subjective than simple yes-no determinations of presence or absence of spots or rings (two characters whose scores did not differ among observers). These differences can be minimised by supplying observers with a large number of reference photographs, showing the range of variation included in each category. In most cases where observers disagreed, their scores were within one grade or level of each other in a series of possible character values.

We found that the scores of each observer were relatively consistent in finding inter-island differences in the presence of spots in each field ($p < 0.05$ for 3 of 5 observers) and in the spacing of rings ($p < 0.05$ for 3 of 5 observers). In each case, seals from San Nicolas Island differed most from those at San Miguel and Santa Rosa Islands; they were more likely to have an absence of spots in some body areas and their rings tended to be more widely spaced. Seals from San Nicolas Island were more similar to those at Santa Rosa Island than they were to those at San Miguel Island. The direction of these differences correlates with the geographic distances among islands and may suggest directional, limited gene flow among the Channel Islands, although studies using molecular techniques are needed to test that hypothesis further.

Further fine-scale modification to improve reproducibility and application to photographs of seals from a broader geographic area are needed to determine the technique's value for discriminating among populations of harbor seals. The present scheme is useful, however, for preliminary sorting of photographs and assignment of a seal to a particular pelage type (e.g. both spots and rings present, with spots present in all body areas; Fig. 1). Such sorting makes it easier to determine whether a seal has been photographed before by reducing the number of photographs with which it must be compared. Re-identifications should also, however, be subjected to tests of intra- and inter-observer reproducibility using secondary and tertiary pelage markings to confirm the uniqueness of the primary mark. Such verification may be particularly important in relatively large populations where the probability of occurrence of two or more animals with similar patterns increases.

Identification of individuals by natural markings, especially pigmentation patterns, has been successfully used in long-term demographic and behavioural studies of birds and terrestrial mammals (e.g. Evans, 1979; Packer *et al.*, 1988; Scott, 1988) and has shown promise for long-term demographic analyses of some cetaceans (e.g. see IWC, 1990).

Although the use of pigmentation patterns of marine mammals has become popular for individual identification, fewer attempts have been made to apply it to investigate stock or population differences (e.g. Chittleborough, 1965; Evans, Yablokov and Bowles, 1982; Perrin, 1972). Our studies (here and Stewart and Yochem, 1989) suggest that pelage patterns of harbor seals and, perhaps, other pinnipeds (e.g. crabeater, Weddell, Baikal, Caspian and ringed seals) with complex, polymorphic patterns, can be used for demographic studies of local populations and for assessments of inter-population relationships.

ACKNOWLEDGEMENTS

We thank L. Popov (VNIRO, Moscow, USSR) for his support of this project, for his assistance in logistical arrangements in the Soviet Union, and for arranging for photographs of largha skins to be made. We also thank G. Klevezal, E. Smirina, L. Suchovskaja, A. Valetsky and M. Vladimitskaja (N.K. Koltzoff Institute of Developmental Biology), S. Kohl (U.S. Fish and Wildlife Service), W.E. Evans (U.S. Dept. of Commerce), R.V. Miller (NOAA, NMFS) and D.B. Kent (HMRC, SWRI) for their support of and assistance in this project. We thank O.A. Scarlato, G. Baryshnikov and A. Aristov for arranging access to specimens at the Zoological Museum of the Academy of Sciences (USSR). We also thank the Sea World, Inc. Animal Care department (San Diego, California) for their help and cooperation with studies of captive seals, R. Dow and his staff and the Commands at Point Mugu and San Nicolas Island for their assistance in the pinniped research of BSS and PKY on San Nicolas Island, W. Ehorn and his staff at the Channel Islands National Park for their assistance in studies at San Miguel Island, and the United States Coast Guard Aviation Detachment (Long Beach, California) for helicopter transport of US and Soviet Scientists to San Miguel Island in October 1987. This cooperative research was conducted under Project V.6. Marine Mammals, of the US-USSR Agreement on Cooperation in the Field of Environmental Protection. The work of PKY and BSS was partially supported by funds provided by the *Windstar Foundation* and by the *Helmsmen*.

REFERENCES

- Aldalsteinsson, S. 1970. Colour inheritance in Icelandic sheep and relation between colour, fertility, and fertilisation. *J. Agr. Res., Iceland* 2(1):3-135.
- Aldalsteinsson, S. 1974. Inheritance of the palomino colour in Icelandic horses. *J. Hered.* 65:15-20.
- Belkin, A.N. 1964. A new species of seal from the Kuril-Islands - *Phoca insularis* sp. n. *Doklad. Akad. Nauk. SSSR.* 158:1217-20.
- Berry, R.J. 1969. Non-metrical skull variation in two Scottish colonies of the grey seal. *J. Zool.* 157:11-18.
- Berry, A.C. 1974. The use of non-metrical variations of the cranium in the study of Scandinavian population movements. *Am. J. Phys. Anthropol.* 40:345-58.
- Berry, A.C. and Berry, R.J. 1967. Epigenetic variation in the human cranium. *J. Anat.* 101:361-70.
- Berry, A.C. and Berry, R.J. 1972. Origins and relationships of the ancient Egyptians. Based on a study of non-metrical variations in the skull. *J. Human Evol.* 1:199-208.
- Burns, J.J., Fay, F.H. and Fedoseev, G.A. 1984. Craniological analysis of harbor and spotted seals of the North Pacific region. U.S. Dept. Commerce, NOAA Tech. Report NMFS 12, Vol. 1 (Pinnipeds):5-16.
- Burns, J.J. and Gol'tsev, V.N. 1984. Comparative biology of harbor seals, *Phoca vitulina* Linnaeus 1758, of the Commander, Aleutian, and Pribilof Islands. U.S. Dept. Commerce, NOAA Tech. Report NMFS 12, Vol. 1 (Pinnipeds):17-24.
- Chittleborough, R.G. 1965. Dynamics of two populations of the humpback whale, *Megaptera novaeangliae* (Borowski). *Austr. J. Mar. Freshwater Res.* 16:33-128.
- Delyamure, S.L., Yurakhno, M.V., Popov, V.N., Shults, L.M. and Fay, F.H. 1984. Helminthological comparison of subpopulations of Bering Sea spotted seals, *Phoca largha* Pallas. U.S. Dept. Commerce, NOAA Tech. Report NMFS 12, Vol. 1 (Pinnipeds):61-5.
- Evans, M.E. 1979. Aspects of the life cycle of the Bewick's swans during winter. *Wildfowl* 29:118-22.
- Evans, W.E., Yablokov, A.V. and Bowles, A.E. 1982. Geographic variation in the colour pattern of killer whales (*Orcinus orca*). *Rep. int. Whal. Commn* 32:687-94.

- Fedoseev, G.A. 1984. Use of non-metrical characters of skulls of Bering sea seals in a study of the Phenotypic structure of their populations. U.S. Dept. Commerce, NOAA Tech. Report NMFS 12, Vol. 1 (Pinnipeds):49-54.
- Gill, A.E. 1976. White spotting in the California vole. *Heredity* 37:113-28.
- Kelly, B.P. 1981. Pelage polymorphism in Pacific harbor seals. *Can. J. Zool.* 59:1212-19.
- Kinze, C.C. 1985. Intraspecific variation in Baltic and North Sea harbour porpoises (*Phocoena phocoena* L., 1758), *Vidensk. Meddr dansk naturh. Foren.* 146:63-74.
- McLaren, I.A. 1966. Taxonomy of harbor seals of the western North Pacific and the evolution of certain other hair seals. *J. Mammal.* 47:466-473.
- Murray, J.D. 1981a. A pre-pattern formation mechanism for animal coat markings. *J. Theor. Biol.* 88:161-99.
- Murray, J.D. 1981b. On pattern formation mechanisms for lepidopteran wing patterns and mammalian coat patterns. *Phil. Trans. R. Soc. London, Ser. B.* 295:473-96.
- Murray, J.D. 1988. How the leopard gets its spots. *Sci. Am.* 258(3):79-87.
- Murray, J.D. and Maini, P.K. 1986. A new approach to the generation of pattern and form in embryology. *Sci. Progr.* 70(280 Part 4):539-53.
- Naito, Y. and Nishiwaki, M. 1975. Ecology and morphology of *Phoca vitulina largha* and *Phoca kurilensis* in the southern sea of Okhotsk and northeast of Hokkaido. *Rapp. P.-V. Réun. CIEM* 169:379-86.
- Packer, C., Herbst, L., Pusey, A.E., Bygott, J.D., Hanby, J.P., Cairns, S.J. and Mulder, M.B. 1988. Reproductive success of lions. pp. 368-88. In: T.H. Clutton-Brock (ed.), *Reproductive Success*. University of Chicago Press, Chicago. 538pp.
- Perrin, W.F. 1970. Colour pattern of the eastern Pacific spotted porpoise, *Stenella graffmani* Lonnberg (Cetacea, Delphinidae). *Zoologica* 54:135-42.
- Perrin, W.F. 1972. Colour patterns of spinner porpoises (*Stenella* CF. *S. longirostris*) of the eastern Pacific and Hawaii, with comments on delphinid pigmentation. *Fish. Bull., US* 70:983-1003.
- Scott, D.K. 1988. Breeding success in Bewick's swans. pp.220-36. In: T.H. Clutton-Brock (ed.), *Reproductive Success*. University of Chicago Press, Chicago. 538pp.
- Searle, A.G. 1968. *Comparative Genetics of Coat Colour in Mammals*. Logos Press, London.
- Shaughnessy, P.D. and Fay, F.H. 1977. A review of the taxonomy and nomenclature of North Pacific harbour seals. *J. Zool.* 182:385-419.
- Shults, L.M. 1982. Helminths of the spotted seal, *Phoca largha*, from the Bering Sea. *J. Wildl. Dis.* 18:59-62.
- Stewart, B.S. and Yochem, P.K. 1989. Photo-identification studies of the demography of harbor seals in the Channel Islands National Marine Sanctuary; a preliminary assessment and catalog, 1987/88. SWRI/HMRC Tech. Report 89-214.
- Tikhomirov, E.A. 1966. Development and variation of colouration in the pelage of the ribbon seal. *Izv. TINRO* 58:239-40.
- Zar, J.H. 1984. *Biostatistical Analysis*. Prentice-Hall, Inc. Englewood Cliffs, New Jersey. 2nd edition. 718pp.

Analytical Problems



Examining the Validity of Inferences Drawn from Photo-Identification Data, with Special Reference to Studies of the Killer Whale (*Orcinus orca*) in British Columbia

David Bain

Marine World Foundation, 2001 Marine World Parkway, Vallejo, CA 94589, USA (Present address)
and *Long Marine Lab., Institute of Marine Sciences, Univ. California, Santa Cruz, CA 95064, USA*

ABSTRACT

Photo-identification is a method for documenting the presence of a particular individual. Repeated photographs of individuals have been used to infer additional information, such as the sex, approximate age and home range of individuals, and the social organisation, age-sex composition and life history parameters of populations. However, inaccurate identifications, unidentified individuals and other biases are potential sources of uncertainty in these estimates. The inferences are like threads. If correct, they may be woven together to produce an elegant portrait of a species' socioecology; or, if there are errant conclusions, they may produce a hopeless tangle of contradictions.

In this paper, data from killer whales are used to illustrate the process of examining for contradictions. Data sets used include preliminary and updated results from British Columbia and Washington State, commercial whaling data, studies of captive killer whales and studies of related species. Conclusions derived from photo-identification data are examined for internal consistency and against conclusions drawn from other data sets. Problems found in the preliminary results show this method may detect contradictions, while the general consistency of the recent results suggests that interpretations will undergo only minor revisions in the future.

INTRODUCTION

Photo-identification of individuals is a method believed to provide great insights into the socioecology and population dynamics of wild animals (see IWC, 1990). However, the statistical tests of confidence often used to estimate the 'reliability' of conclusions rely on many assumptions, some of which are violated by natural populations. For example, the Peterson method for estimating population size within confidence limits assumes individuals are equally sightable (Seber, 1982). However, sighting records often show large variation in sightability between individuals (e.g., see relative numbers of encounters reported in Table 1 of Olesiuk and Bigg, 1990; and the discussion in Hammond, 1986). Thus additional testing is required to estimate uncertainty beyond statistical confidence intervals. One way to examine reliability is to derive parameters by more than one method and determine how well they agree. This paper illustrates the approach of deriving multiple estimates of a single parameter to infer reliability. It must, of course, be remembered that *all* methods of estimating parameters will have their associated assumptions and resultant biases or uncertainty (see below).

The first part of the paper will review some of the results obtained in photo-identification studies of killer whales (*Orcinus orca*) inhabiting the waters of British Columbia and Washington State. Then, a number of 'tests' will be conducted. For each, the methods for deriving parameters will be given, and the degree of concordance will be discussed. The exercise will focus on the community of killer whales resident to the northern waters of British Columbia, the one with which I am most familiar (Bain, 1988a). The paper will conclude with some general comments on the validity of the inferences drawn from photo-identification work on this population of killer whales.

Background

Bigg, Olesiuk, Ellis, Ford and Balcomb (1990) used over 40,000 photographs to document the presence of individual killer whales in British Columbia waters from 1973 to 1987.

These photographs appeared to include all the individuals resident in the area. In the course of analyzing these photographs, they noted the appearance of new calves and the disappearance of a small number of individuals from the study area. They found recurrent associations between adult females and juveniles, and suggested this information could be used to identify matrilineal (lineages of descent along female lines). The photographs also appeared useful in estimating ages of whales. Since *Orcinus* is sexually dimorphic, they have been able to determine the sex of nearly all the individuals alive at the start of their study.

Bigg *et al.* (1990) estimated ages in a variety of ways. For a whale born during the study, they used the date it was first sighted. For a whale which was still growing, they used relative sizes. They used the ages of an adult female's offspring to determine her age. They did not estimate the age of a male that was fully adult at the start of the study, except to indicate a minimum age. (For the purposes of testing ages, I estimated males' ages to be compatible with those of other family members; Bain, 1988a). The methods and assumptions used in generating these results appear in more detail in Olesiuk and Bigg (1990).

Bigg, Ellis, Ford and Balcomb (1987) and Bigg *et al.* (1990) described three communities of killer whales: the 'northern resident community' which ranges from central Vancouver Island to southeast Alaska; the 'southern resident community' which ranges from Vancouver Island to Washington State; and the 'transient community' whose range overlaps with the ranges of both resident communities. Despite overlapping ranges, members do not associate with members of the other communities, and morphological differences exist between the communities (Bain, 1988a; Baird and Stacey, 1988).

The validity of Bigg *et al.*'s (1990) interpretations of matrilineal relatedness, age, sex and patterns of dispersal, and the recognizability of all individuals, are critical for other studies on the socioecology of killer whales in British Columbia. For example, Ford (1984) concluded that patterns of similarities and differences in vocal repertoires reflected matrilineal relatedness. He speculated that clans

of killer whales descended from a single female could be identified from sounds. Waite (1988) concluded that males exhibited alloparental care only towards close kin, while female alloparental care was directed towards calves independent of relatedness. Bain (1988a) concluded that the similarity of two individuals' dorsal fin shapes could be predicted in part on the basis of matrilineal relatedness and age. These and some of the studies in the volume edited by Kirkevold and Lockard (1986) assume that Bigg *et al.*'s interpretations are correct, yet their conclusions have not been tested. The difficulty (both technical and political) in obtaining direct measures of age and relatedness of individuals in these populations prompted this effort to develop methods for 'testing' these results indirectly. The methods employed here may prove valuable in other photo-identification studies which are believed to include all individuals utilizing a study area.

Three of Bigg's (1982) results appeared surprising. First, he concluded that offspring of both sexes remained with their mothers throughout life, although dispersal of at least one sex is almost universal in birds and mammals (Greenwood, 1980). Second, birth rates appeared to be very low compared with pregnancy rates obtained from commercial data (IWC, 1982). Third, longevity appeared to be much greater than anticipated based on earlier work (see Mitchell and Baker, 1984). These conclusions will be examined in more detail below.

The 'testing' process used here is to assume that all of Bigg *et al.*'s (1990) conclusions are correct. Corollaries of their results are then derived. Population parameters such as mortality rates and recruitment rates can be calculated in more than one way and this allows different estimates of the same parameter to be compared. If some of Bigg *et al.*'s interpretations are incorrect, then contradictory results are likely to be obtained. Contradictions between these estimates might reflect broad statistical confidence intervals, bias in the data, variation through time of the population parameter or misinterpretation of the data. Consistency among the corollaries would not prove the correctness of the original interpretations, but would greatly strengthen their credibility (Ohala, 1984).

Comparative data with other species may also provide useful tests. For example, longevity has been estimated as a function of brain and body size in mammals (Sacher, 1980). Kasuya and Marsh (1984) and Marsh and Kasuya (1984) determined many population parameters of the closely related pilot whale, *Globicephala macrorhynchus*, which can be compared to those derived for killer whales. To search for contradictions, I addressed the four questions.

- (1) How reliable are the matrilineal lines generated by Bigg *et al.* (1990)?
- (2) How well do the pregnancy rates deduced by Olesiuk and Bigg (1990) agree with those obtained from commercial whaling?
- (3) How reliable are the lifespan estimates reported by Olesiuk and Bigg (1990)?
- (4) What other data would be useful for testing photo-identification results?

HOW RELIABLE ARE MATRILINES?

Bigg *et al.* (1990) used association indices and subjective assessment of behavior in the wild to estimate relatedness. In addition, they used estimated minimum ages and

reproductive status to determine which individuals were likely the mother or daughter in highly associated female-female pairs.

Preliminary derivations by this method faced several difficulties. The duration of the study was short relative to the lifespan, so that changes in association index with age were unknown. The variance in estimates due to other factors was unknown as well (Bigg pers. comm.).

To examine whether these difficulties had successfully been overcome in Bigg *et al.*'s (1990) current work, two parameters were derived from the proposed lineages and ages. First, the sex-ratio of the eldest surviving offspring (surviving meaning it lived long enough during the study to be assigned to its apparent mother) was determined for all females for which the sex of the eldest offspring was known. Fisher (1958) argued that the sex-ratio was likely to be near 1:1 and this was assumed to be the case by Olesiuk and Bigg (1990). A finding of a sex-ratio different from 1:1 might suggest misinterpretation (but see discussion below).

Second, mortality of females directly ancestral to the study population was very roughly estimated. Bigg *et al.* (1990, and pers. comm.) assigned lineages at three levels of certainty. They increased the number of assumptions made to reduce the number of separate lineages, until they could find no consistent basis for forming additional links. (Bigg *et al.* chose to be conservative and did not attempt to link all related individuals, if linking could not be done in a consistent manner). If each lineage is actually not related closely to any other lineage, then each would have a separate founding female which died prior to the study. In addition, these founding females must have been alive at the time of birth of the whales in the first generation of each proposed lineage. These two facts allow estimation of mortality in this implied population of ancestral females, which may be compared to those derived for known females. If fundamental assumptions about social organization, such as that there is no emigration or immigration across community boundaries, are correct; then a finding that too many females had died would suggest either mortality rates were higher in the past than at present, or that related lineages had not been connected. A finding that too few females had died would suggest that apparently related individuals are, in fact, unrelated.

Methods

A data base was constructed containing: the identity of each individual; its sex, if known; the mother of the individual, if known; the offspring of the individual, if any; the estimated year of birth; and the estimated year of death, if the individual had died. A program was developed to extract from this data base the population parameters discussed below.

The database contained all known offspring of a female sorted by age. Software was developed to report the number of eldest offspring which were male, female and unknown. The sex-ratio of known sex individuals was determined. This was compared to the expected 1:1 ratio. Sex-ratios were determined for an early 'provisional' lineage (Bigg pers. comm.) and the current lineage (Bigg *et al.*, 1990). The provisional lineage was believed to be inaccurate but was used to illustrate tests for internal consistency.

The lineages in Bigg *et al.* (1990) were assigned a hypothetical ancestral female. The number of lineages not shown to be related to any other was counted. The

estimated year of birth of the oldest known whale was used to obtain a conservative estimate of the time period over which hypothetical ancestral females died. The number of females that died between the 1973 and 1988 field seasons was counted to obtain an estimate of the expected number of deaths in the population per year.

Results and discussion

In the early provisional lineages, the sex-ratio of the eldest offspring appeared to be male-biased (>3:1). This was surprising since a sex ratio of 1:1 at birth followed by higher male mortality would be expected to result in most eldest surviving offspring being female. In addition, if there were really as many separate matrilineages as shown, then female mortality rates must have been much greater in the past than at present.

This suggested two corrections. First, males with association indices which were low relative to known sons were unlikely to be offspring of the females with whom they travel, and were more likely brothers or more distant relatives. Second, many females with low association indices relative to known mother-daughter pairs were probably closely related.

To determine which female in a pair was more likely to be the mother, ages of females were estimated from the ages of their more obvious offspring (see Bigg *et al.*, 1990). After combining females into and separating males out of matrilineages, a sex-ratio closer to 1:1 for first-born offspring was obtained, but it is still male biased (25:19 in Bigg *et al.*, 1990, for northern residents).

It is unclear whether this bias reflects inaccuracy in the interpretations (e.g., due to biases in age determination or incorrect determination of relationships), since it does not differ significantly from 1:1 ($p > 0.1$). In addition, the sex-ratio at birth may, in fact, be male-biased.

Most stranded neonates have been male (7:1 – table 5 in Olesiuk and Bigg, 1990). The majority of resident juveniles removed in capture operations were males (23:17 – tables 2 and 3 in Bigg, 1982). Finally, most adults that have died have been male, suggesting more males than females reach adulthood (17:5 – table 13 in Olesiuk and Bigg, 1990). Clutton-Brock and Iason (1986) reviewed the literature on sex-ratio variation in mammals and found many examples of moderately skewed sex-ratios.

Six females died in the northern resident community over a 15 year period (0.4 per year) from 1973 to 1988. There are 34 lineages shown by Bigg *et al.* (1990) for this community, in which the oldest individual has an estimated birth year of 1919. The 34 deaths represent at least 1.4 times as many deaths as expected (0.56 per year). Females who are not immediately ancestral to the lineages shown may have died, and the population was likely to have been smaller in the past than in recent years.

Both of these tests suggest that a small number of errors have been made in assigning relatedness. These are most likely to be in the form of failing to recognize adult female-adult female relations (Bain, 1988a). If so, the permanence of female-female association has been overstated in Bigg's (1982) earlier work, and the genetic relationships among a small number of females would be closer than presently recognized.

Bain (1988a) combined more lineages than Bigg *et al.* (1990) on the basis of females being sighted in the same general area on a given day, rather than on a photograph by photograph basis. If Bain's tree turns out to be more accurate than that in Bigg *et al.* (1990), it would indicate

that although association indices based on individual photographs seem to be the best approach for determining male-adult female relatedness, presence in the same general area may be a more useful measure of relatedness among adult females.

HOW WELL DO PREGNANCY RATES DERIVED FROM PHOTOIDENTIFICATION AGREE WITH THOSE DERIVED FROM COMMERCIAL WHALING?

I here define the annual pregnancy rate to be the percentage of mature females pregnant divided by the length of gestation in years, following Perrin and Reilly (1984). The estimation of pregnancy rates of killer whales by any method has proven difficult, as evidenced by the wide range of estimates, both in percentage pregnant and the gestation length (IWC, 1982). The available data for addressing pregnancy rates include commercial takes in the Antarctic (Anderson, 1982) and the North Atlantic (Christensen, 1982; 1984), interspecific comparisons (reviewed in Perrin and Reilly, 1984), gestation length in captivity (Walker, Cornell, Dahl, Czekala, Dargen, Joseph, Hsueh and Lasley, 1988) and the photo-identification data of Olesiuk and Bigg (1990). In this section, I derive new estimates of pregnancy rates from commercial whaling data and compare them to rates derived from photo-identification in different ways.

Perrin and Reilly (1984) listed some assumptions used in deriving pregnancy rates from commercial whaling data. These assumptions and the consequences of their violation are discussed below. In addition, assumptions are required to derive pregnancy rates from observed calving intervals using the photo-identification method. Since most of these assumptions have been violated, possible corrections will be discussed as well.

- (1) *There is no sampling bias caused by selectivity for females at a particular stage of the reproductive cycle.* Christensen (1982) stated that females with new calves were less likely to be taken. Since females are rarely pregnant and lactating (Mikhalev, Ivashin, Savusin and Zelenaya, 1981), the reduced take of cows with young calves violates the assumption of no selectivity. This factor would lead to an overestimate of pregnancy rate. No data are provided to judge whether there was any selectivity in the Antarctic catch.
- (2) *There is no sampling bias caused by seasonality of calving.* It is possible to correct for this when seasonality is known, or calving is distinctly seasonal (as may be the case for the Antarctic whaling data: Anderson, 1982; Perrin and Reilly, 1984). Christensen (1984) was troubled by the small number of near-term fetuses in his data. This could be interpreted as bias due to calving seasonality. Fig. 6 of Olesiuk and Bigg (1990) shows apparent peaks in calving in February-March and September-November, which correspond to months in which samples were small ($N=3$ for February-March, $N=2$ for September) or large fetuses were found (October-November) in the Norwegian sample.
- (3) *All pregnancies are detected.* Small fetuses are likely to be missed, and Christensen (1984) found a higher pregnancy rate by examining ovaries than when reports of fetuses alone were used (e.g. Jonsgård and Lyshoel, 1970). Perrin and Donovan (1984) concluded that ovarian analysis may overestimate pregnancy rate

due to difficulty in distinguishing corpora of pregnancy from other corpora. By segregating the fetuses in the Antarctic sample by year of conception, the problem of small fetuses and ovarian analysis can be avoided by analyzing only the larger year class.

Another potential correction is required on the basis of the gestation period. This is not well established for the killer whale. Estimates ranged from 11 to 16 months (Perrin and Reilly, 1984), and pregnancy rates have been estimated on the basis of 12 and 15 month gestations. However, more recent data suggest gestation is 16–17 months (Matkin and Leatherwood, 1986; Walker *et al.*, 1988; and see Nishiwaki and Handa, 1958), and no estimates are available using this correction.

Pregnancy rates may be approximated as the reciprocal of the calving interval (Perrin and Reilly, 1984). Although the interval between viable calves may be determined using photo-identification, pregnancy rates are not directly accessible to photo-identification studies. Since the apparent calving interval in cases where a calf dies before it is photographed is actually the sum of: (a) the interval between the previous surviving calf and the dead calf; and (b) the interval between the dead calf and the next surviving calf; these deaths will result in artificially long calving intervals. In addition, the intervals will only involve females of reproductive age and thus a correction for post-reproductive individuals is required.

Methods

Corrected pregnancy rates were derived for commercial whaling data as described below.

North Atlantic

The ratio of pregnant to lactating females was calculated from Table 1 and Table 2 of Christensen (1984) to determine whether the sub-sample chosen for ovarian analysis had the same composition as the general 1978–1980 catch.

Christensen (1982) reported the proportion mature for females in different length classes based on ovarian analysis. Christensen (Table 4, 1982) also reported the number of females of each length taken in 1978–1980. The numbers of females in the 15–17ft length classes were multiplied by the respective proportions of females mature in each length class and added to the number of larger females to determine the number of mature females taken (146). He reported that 56 of these females were pregnant, which yields a proportion pregnant of 38.3%.

Olesiuk and Bigg (1990) estimated variation in the proportion pregnant in British Columbia by month. Assuming seasonality of calving and pregnancy rates in the North Atlantic and North Pacific are similar, it is possible to predict the seasonally adjusted proportion pregnant that would be found in the Norwegian catch. The temporal distribution of 273 of the 342 whales taken was determined from Table 4 in Christensen, Jonsgård and Rorvik (1981; 1982). The distribution of the catch by month was used to determine a weighted average of the monthly estimates of the proportion pregnant given in Olesiuk and Bigg (1990). This value (37.5%) was compared with the value obtained above to assess their agreement. The same method was used to estimate the expected proportion pregnant in the sample subjected to ovarian analysis (Christensen, 1984), and a rate of 38.1% was obtained.

Southern Ocean

The Antarctic catch showed a bimodal length distribution. Anderson (1982) interpreted the modes as being due to conceptions from two different breeding seasons. Anderson estimated corrections based on a 15 month gestation period. These corrections are recalculated here based on a 515 day gestation period (Walker *et al.*, 1988).

The growth of fetuses was estimated using the method of Hugget and Widdas (1951) and length-growth rate regression equation determined by Kasuya (1977) for delphinids ($y = 0.001462x + 0.1622$ where y = the daily growth increment and x = the mean neonatal length in cm). They divided fetal growth into two time periods. It is assumed that growth is negligible during the first period, called t_0 . During the second period, growth is assumed to be linear, and the rate of growth is a function of size at birth. Assuming a birth length of 270cm (about 9ft), the daily growth increment was estimated at 0.57cm. This corresponds to a growth period ($t_g - t_0$) of 476 days, and a t_0 of 39 days. Fetuses would grow 186cm in the first year (in the 326 days after t_0), and approximately 208cm in the last year of gestation. Fetuses in the first year of growth range from 0 to 186cm (0 to 6ft), and fetuses in the last year of development would range in length from around 62 to 270cm (2 to 9ft). Using the length distribution in Anderson (1982), 48% were estimated to be in the first year of development, while 63% were in the last year of development (these numbers add to over 100% because gestation lasts between one and two years). This corresponds to about 69 and 90 calves, respectively, per 428 mature females. This leads to estimates of pregnancy rates of 16% based on young fetuses and 21% based on fetuses in the last year of development. Since small fetuses were more likely to be missed, I consider the larger figure to be less biased.

Photo-identification estimates

Pregnancy rates were calculated from photo-identification data as described below.

A model was developed to estimate the number of calves which die before being photographed from the distribution of apparent calving intervals. Since apparent calving intervals, x , are based on annual censuses, they are limited to having integral values. The model assumes that following the birth of a viable calf, there is a normally distributed calving interval with mean, I_v , and variance, s^2 . If this next calf should die before it is photographed, the female will give birth to additional calves at a fixed interval, I_n , until a viable calf is produced. I_n was fixed at two years, a value found in both captive and wild killer whales known to have lost a calf shortly after birth (Hoyt, 1981; Olesiuk and Bigg, pers. comm.). (A random interval could have been used here, but a realistic variance would probably be too small to detect with an annual census outside the calving season). The probability of a calf being stillborn or dying before it is photographed (m) is assumed to be independent of the fate of previous calves.

The relative probability, P , of an apparent calving interval of x years was calculated as

$$P(x) = \sum_{i=0}^N (e^{-(x-I_n)^2/2s^2}) (1-m)^i$$

where i is the number of calves that died before being photographed, N is the upper limit on this number (set in the case of the data collected by Bigg *et al.*, this volume, as values of i corresponding to 0 to 14 years; and in principle by the maximum reproductive span).

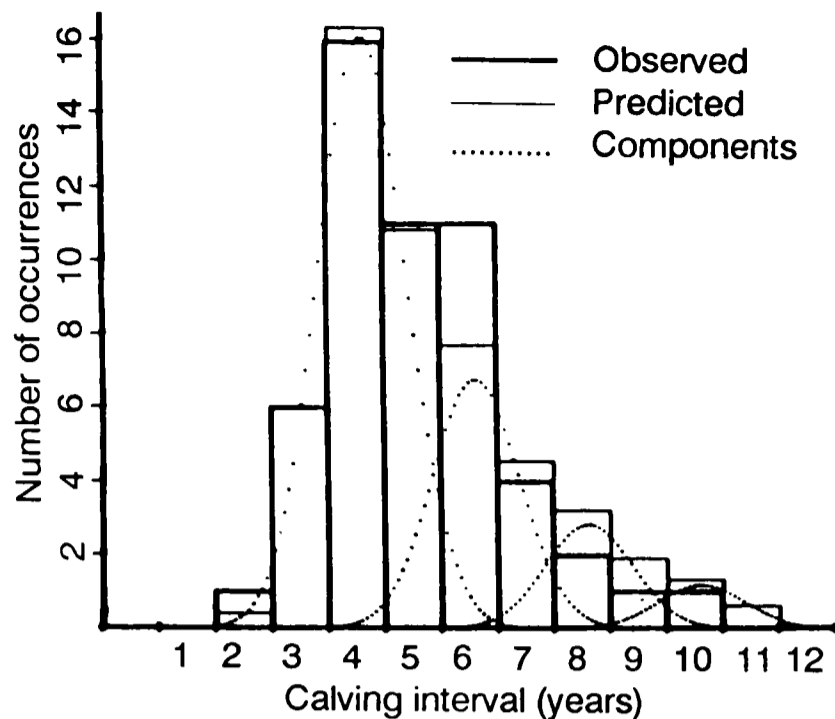

Fig. 1. Observed and Modelled Apparent Calving Intervals. Observed intervals (from Olesiuk and Bigg, 1990) are shown by the heavy line, and predicted intervals are shown by the light line. The dotted lines show the distributions of viable calves. Note that the first calf is centered at 4.1 years, and each subsequent calf appears after 2 more years. The declining magnitude with increasing intervals reflects the joint probabilities of preceding calves dying and the present calf surviving.

I_v , s and m were varied and a least-squares criterion was used to determine the combination of values producing the best fit to the distribution of apparent calving intervals provided by Olesiuk and Bigg (pers. comm.). Fig. 1 shows the observed intervals in comparison to those generated by the model. Fig. 2 shows the relative sensitivity of the goodness-of-fit to changes in calving interval and mortality rate.

The calving intervals were converted to a pregnancy rate as follows. The mean calving interval, I_m , was the average of I_v and I_n weighted by their relative probability of occurrence (0.58 and 0.42, respectively) i.e. 3.2 years. Since the maximum interval between calves of a given female was 25 years, the number of intercalving-intervals was taken as I_m divided by 25. The number of calves produced is one more than the number of intervals (8.8). This corresponds to 35% of females of reproductive age becoming pregnant each year. Since 39 of 54 adult females were considered to be of reproductive age (72%, Bain, 1988a), the proportion of adult females becoming pregnant each year is estimated at 25%. Olesiuk and Bigg (1990) obtained a similar value.

Results and discussion

Bias seems to be a problem in the Norwegian data. In Christensen's (1984) Table 1, the ratio of lactating to pregnant females is 11:56 (=0.16). In the sample used for ovarian analysis, the ratio was 10:19 (=0.34). Since the ratio of the proportion lactating to the proportion pregnant would equal the ratio of the mean duration of lactation to the mean gestation period in an unbiased sample (Perrin and Reilly, 1984), knowledge of the duration of lactation might be used to determine which sample is most representative (Heyning, 1988, suggested that lactation lasts at least six months). However, seasonality and the question of whether the proportion resting is biased would still need to be resolved.

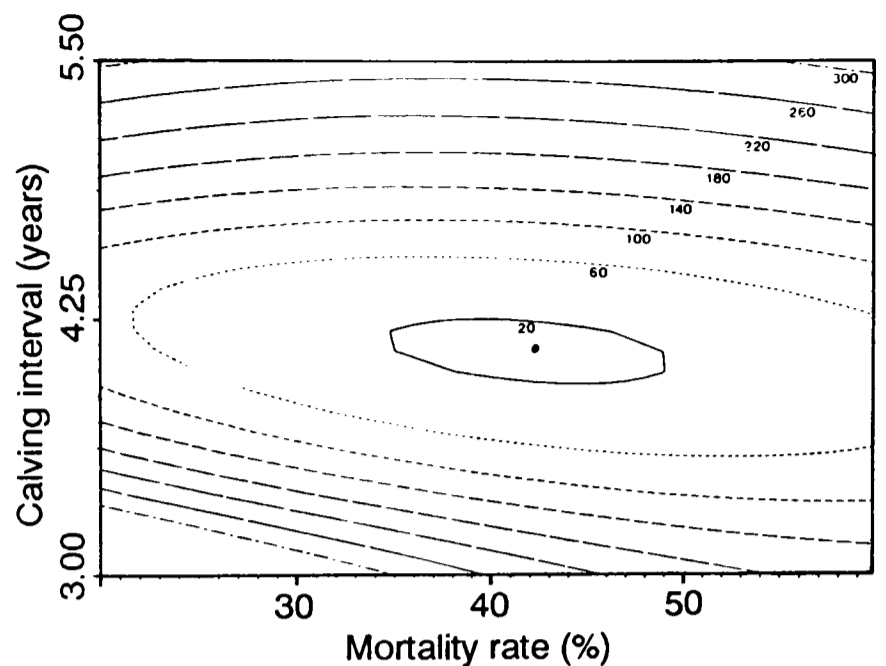

Fig. 2. Goodness of fit of observed and predicted calving intervals as a function of estimated mortality rates and calving intervals. Contours represent equal goodness of fit. The central point represents the best fit found, 14.67.

The proportion pregnant in the 1978–1980 Norwegian catch was 38.3%, against an expected value of 37.5% predicted from photo-identification. These two values agree surprisingly well. In the sample subjected to ovarian analysis, 43% of the females for which both ovaries were available were pregnant, and 37.3% of the females for which at least one ovary was analyzed were pregnant, compared to 38.1% predicted by photo-identification. Whether these actually represent agreement between the two methods depends on bias in the Norwegian catches, and the accuracy with which pregnancy was determined.

Olesiuk and Bigg (1990) estimated that 25% of mature females became pregnant each year. This number is comparable to the 21% found for the Antarctic area. Again, the quality of the agreement depends on whether the Antarctic data are biased, and whether there are any differences in the true rates for the two populations.

The improved agreement between pregnancy rates from photo-identification and commercial whaling relative to Bigg's (1982) earlier work is due primarily to the estimate of neonate mortality rate. The model developed here for estimating neonate mortality produced a best fit for northern residents at $I_v = 4.1$ years, with 95% of births falling within 2.1 years of this interval, and mortality at 42% of all calves born. Olesiuk and Bigg (1990) estimated neonate mortality rates based on the proportion of stranded killer whales which were neonates, the number of calves which were observed near birth which survived or died and an arbitrary estimate of the proportion stillborn. Their estimate was 43%, which is quite similar to the value derived here.

Although at first glance, this high estimate of neonate mortality was surprising, it is consistent with findings from other species. Sumich and Harvey (1986) estimated that 36% of gray whale calves died before reaching 49°N on their first-year northward migration. Sweeney (1977) found that 50% of captive born *Tursiops* died in the first year of life. Finally, Clutton-Brock, Albon and Guinness (1989) suggested that early termination of maternal care would be favored by natural selection over prolonged attempts to rear calves with low viability.

HOW RELIABLE ARE THE AGE ESTIMATES?

A variety of parameters related to age may be estimated to examine the reliability of age estimates. Olesiuk and Bigg (1990) estimated an age structure based on age specific disappearance rates. Alternatively, age structure can be taken directly from Bigg *et al.*'s (1990) estimated ages. Another approach is to look at the number of calves produced in a life-time and calving rates to estimate the span over which females are adult. The age structure of animals which have died could be used, although the sample is too small at this point to be useful (see Fig. 3).

The above values derived from photo-identification could be compared with related values obtained by other methods. For example, maximum longevity was calculated by Sacher (1980) based on a regression of mammalian brain and body weights. Ages based on tooth growth layer groups offer another possible comparison (Christensen, 1982), although there are difficulties with this technique for animals aged over about 20 years (Myrick, Yochem and Cornell, 1988).

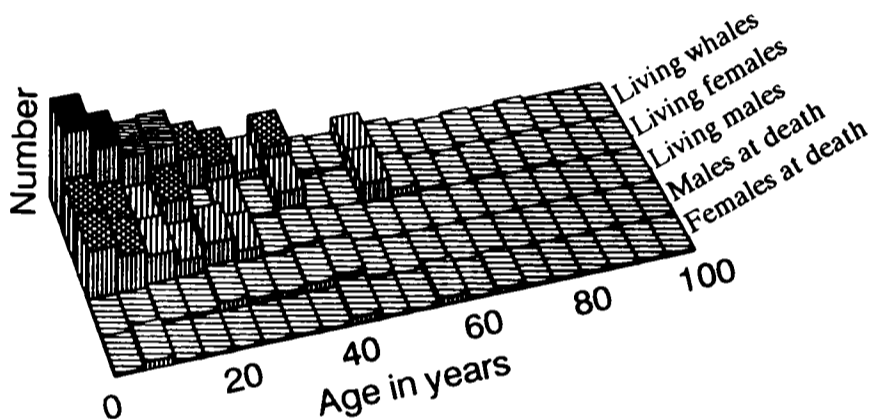

Fig. 3. Estimated age structure of the northern resident community. This histogram shows: (a) all living whales combined; (b) living females; (c) living males; (d) estimated age at death of males; (e) estimated age at death of females.

Methods

Estimates of age-related parameters such as mean life expectancy at maturity and maximum longevity were obtained from the literature.

The mean life expectancy at maturity for adult females was calculated as follows. The mean number of viable calves produced in a lifetime was estimated (see above). This was divided by the mean number of calves produced per female per year.

Results

Table 1 shows a variety of estimates of ages obtained by killer whales. Estimates for the related pilot whale are shown for comparison.

Discussion

Bigg (1982) noted that his estimate of mean life expectancy at maturity appeared to be unrealistically high. Factors contributing to that result include the broad confidence intervals resulting from the small number of deaths in his sample, and that the conversion from disappearance rate to life expectancy did not take age-specific mortality into account (Olesiuk and Bigg, 1990).

The numbers in the table represent a variety of parameters, such as mean life expectancy at different ages and maximum longevity of the two sexes. With the exceptions of the early disappearance rate estimate and the growth layer group estimate, these values appear to agree

Table 1

Lifespan estimates for the killer whale. Estimates are based on four different interpretations of photo-identification data, growth layer group data, and brain-body-weight-longevity relationships among mammals. Data for the pilot whale are shown for comparison.

Source of estimate	Estimate (yr)
Disappearance rate (Bigg, 1982)	
of adult females (at maturity)	Mean >150
of adult males (at maturity)	Mean >48
Disappearance rate (Olesiuk and Bigg, 1990, Tables 16-17 corrected for age-specific mortality rates)*	
of females reaching 0.5 years of age	Mean = 46-50
of males reaching 0.5 years of age	Mean = 26-29
Cow-years per calf x calves per lifetime + age at maturity	Mean = 47
Estimated ages	
both sexes combined (of whales reaching 0.5)	Mean = 20
females	Maximum = 81
males	Maximum = 47
Tooth rings (Christensen, 1982)	
females	Maximum = 34
males	Maximum = 32
Brain-body weight and metabolic rate (Sacher, 1980)	Maximum = 72 - 81
Pilot whale ages (Kasuya and Marsh, 1984)	
female	Mean = 20
male	Maximum = 63
	Mean = 13
	Maximum = 46

* Best estimates from photo-identification methods

fairly well. In addition, Bain (1988b) found similar mortality rates among captive killer whales at many aquaria in recent years to those obtained in the wild by the age estimation method.

The maximum estimated ages are in accord with Sacher's (1980) prediction for this species. The mean estimated age of 20 years would be an underestimate of mean life expectancy at birth, since the population has grown by about 40% over the last 15 years (Bigg *et al.*, 1990; Caughley, 1977). The mean estimated age is similar to that suggested by Kasuya and Marsh (1984) for pilot whales, so use of estimated ages and age-specific mortality rates probably have improved estimates of typical lifespans.

The estimates derived from photo-identification are in conflict with data based on growth layer groups (e.g. Christensen, 1984). This is probably due to the difficulties in reading teeth from older animals referred to earlier (Mitchell and Baker, 1980, Myrick *et al.*, 1988) although it may also reflect population differences in survivorship or errant conclusions derived from the photo-identification study.

TESTABLE PREDICTIONS

Testable predictions may be derived from the lineage produced by Bigg *et al.* (1990). For example, proposed mother-offspring relations could be tested using DNA fingerprinting techniques (Jeffreys, Wilson and Thein, 1985a;b; see review by Hoelzel and Dover, 1989). Studies of mitochondrial DNA could be used to test Ford's (1984) clan hypothesis. Age determination of teeth from stranded animals might be used to test proposed ages. These represent direct approaches which could be used in the future to test the results of mature photo-identification studies.

SUMMARY AND CONCLUSIONS

The matriline produced by photo-identification of killer whales in British Columbia appear to be largely correct. The apparent discrepancy between pregnancy rates based on commercial whaling and photo-identification may be due to correctable biases in the two methods and differences in age structure of exploited and unexploited populations. The biggest failure of photo-identification was in estimating life-span based on disappearance rates. This is probably due to statistical problems (see Sokal and Rohlf, 1981) with studies of small populations of long-lived species. However, estimating ages produced more credible results. Unfortunately, the age estimation technique relies on an apparently unique social organization in which offspring of both sexes remain with their mothers throughout life, so it is not likely to be applicable to other species. There do not seem to be any problems derived from misidentifications or incompleteness. Some biases seem correctable, such as the effect of population growth on lifespan estimates, while others are more intractable, such as neonatal mortality estimates. The population growth experienced by northern residents indicates that this population cannot be typical of the species. Additional data will test whether the 15 year record reviewed here is typical of the population, and new techniques will provide more rigorous tests of the tentative conclusions presented to date.

ACKNOWLEDGEMENTS

I would like to give special thanks to Mike Bigg of the Pacific Biological Station in Nanaimo, British Columbia, for providing unpublished data, many helpful discussions over the years, and for reviewing an earlier version of this manuscript. Peter Olesiuk provided much advice on the model for neonate mortality rates and other helpful discussion and encouragement. I also wish to thank Graeme Ellis and John Ford for helpful discussions. Ken Norris, Burney LeBoeuf and Bruce Bridgeman of the University of California at Santa Cruz reviewed earlier drafts of this manuscript, and I thank them and other colleagues at Santa Cruz for helpful discussions. Greg Donovan, Phil Hammond and two anonymous reviewers also provided useful suggestions.

REFERENCES

- Anderson, G.R.V. 1982. A re-examination of pregnancy rates and calf ratios in *Orcinus orca*. *Rep. int. Whal. Commn* 32:629-31.
- Bain, D.E. 1988a. An evaluation of evolutionary processes. PhD. Thesis. Univ. California, Santa Cruz.
- Bain, D.E. 1988b. A journey through the NMFS marine mammal inventory. *Proc. 1987 Annu. Conf. Int. Mar. Anim. Trainers Assoc.*: 103-30.
- Baird, R.W. and Stacey, P.J. 1988. Variation in saddle patch pigmentation in populations of killer whales (*Orcinus orca*) from British Columbia, Alaska, and Washington State. *Can. J. Zool.* 66:2,582-5.
- Bigg, M.A. 1982. An assessment of killer whale (*Orcinus orca*) stocks off Vancouver Island, British Columbia. *Rep. int. Whal. Commn* 32:655-66.
- Bigg, M.A., Ellis, G.M., Ford, J.K.B. and Balcomb, K.C. 1987. *Killer Whales*. Phantom Press, Nanaimo, B.C. 79pp.
- Bigg, M.A., Olesiuk, P.F., Ellis, G.M., Ford, J.K.B. and Balcomb, K.C. 1990. Social organisation and genealogy of resident killer whales (*Orcinus orca*) in the coastal waters off British Columbia and Washington State. Paper SC/A88/ID39 (published in this volume).
- Caughley, G. 1977. *Analysis of Vertebrate Populations*. Wiley and Sons, London. 234pp.
- Christensen, I. 1982. Killer whales in Norwegian coastal waters. *Rep. int. Whal. Commn* 32:633-41.
- Christensen, I. 1984. Growth and reproduction of killer whales, *Orcinus orca*, in Norwegian coastal waters. *Rep. int. Whal. Commn* (special issue 6):253-8.
- Christensen, I., Jonsgård, A. and Røvik, C.J. 1981. Catch statistics for minke whales (*B. acutorostrata*) and killer whales (*Orcinus orca*) caught by Norway in 1979. *Rep. int. Whal. Commn* 31:635-7.
- Christensen, I., Jonsgård, A. and Røvik, C.J. 1982. Catch statistics for minke whales (*Balaenoptera acutorostrata*) and killer whales (*Orcinus orca*) caught by Norway in 1980. *Rep. int. Whal. Commn* 32:487-9.
- Clutton-Brock, T.H., Albon, S.D. and Guinness, F.E. 1989. Fitness costs of gestation and lactation in wild mammals. *Nature, Lond.* 337:260-2.
- Clutton-Brock, T.H. and Iason, G.R. 1986. Sex-ratio variation in mammals. *Quart. Rev. Biol.* 61:339-74.
- Fisher, R.A. 1958. *The Genetical Theory of Natural Selection*. Dover, New York. 291pp.
- Ford, J.K.B. 1984. Call traditions and dialects of killer whales (*Orcinus orca*) in British Columbia. PhD. Thesis. Univ. British Columbia. 435pp.
- Greenwood, P.J. 1980. Mating systems, philopatry and dispersal in birds and mammals. *Anim. Behav.* 28:1,140-62.
- Hammond, P.S. 1986. Estimating the size of naturally marked whale populations using capture-recapture techniques. *Rep. int. Whal. Commn* (special issue 8):253-82.
- Heyning, J.E. 1988. Presence of solid food in a young calf killer whale (*Orcinus orca*). *Mar. Mammal Sci.* 4:68-71.
- Hoelzel, A.R. and Dover, G.A. 1989. Molecular techniques for examining genetic variation and stock identity in cetacean species. *Rep. int. Whal. Commn* (special issue 11):81-120.
- Hoyt, E. 1981. *The Whale Called Killer*. E.P. Dutton, New York, 226pp.
- Hugget, A. St. G. and Widdas, W.F. 1951. The relationship between mammalian foetal weight and conception age. *J. Physiol.* 114:306-17.
- International Whaling Commission. 1982. Report of the workshop on identity, structure and vital rates of killer whale populations, Cambridge, England, June 23-25, 1981. *Rep. int. Whal. Commn* 32:617-29.
- International Whaling Commission. 1990. Report of the Workshop on Individual Recognition and the Estimation of Cetacean Population Parameters (published in this volume).
- Jeffreys, A.J., Wilson, V. and Thein, S.L. 1985a. Hypervariable 'minisatellite' regions in human DNA. *Nature, Lond.* 314:67-73.
- Jeffreys, A.J., Wilson, V. and Thein, S.L. 1985b. Individual-specific 'fingerprints' of human DNA. *Nature, Lond.* 316:76-9.
- Jonsgård, A. and Lyshoel, P.B. 1970. A contribution to the knowledge of the killer whale *Orcinus orca* (L.). *Nytt. Mag. Zool.* 18:41-48.
- Kasuya, T. 1977. Age determination and growth of the Baird's beaked whale with a comment on the fetal growth rate. *Sci. Rep. Whales Res. Inst., Tokyo.* 24:57-79.
- Kasuya, T. and Marsh, H. 1984. Life history and reproductive biology of the short-finned pilot whale, *Globicephala macrorhynchus*, off the Pacific coast of Japan. *Rep. int. Whal. Commn* (special issue 6):259-310.
- Kirkevold, B.C. and Lockard, J.S. (Eds). 1986. *Behavioral Biology of Killer Whales*. Liss, New York. 457pp.
- Marsh, H. and Kasuya, T. 1984. Changes in the ovaries of the short-finned pilot whale, *Globicephala macrorhynchus*, with age and reproductive activity. *Rep. int. Whal. Commn* (special issue 6):311-35.
- Matkin, C.O. and Leatherwood, S. 1986. General biology of the killer whale, *Orcinus orca*: a synopsis of knowledge. pp. 35-68. In: B.C. Kirkevold and J.S. Lockard (Eds.) *Behavioral Biology of Killer Whales*. Alan R. Liss, New York. 457pp.
- Mikhalev, Yu. A., Ivashin, M.V., Savusin, V.P. and Zelenaya, F.E. 1981. The distribution and biology of killer whales in the Southern Hemisphere. *Rep. int. Whal. Commn* 31:551-66.
- Mitchell, E. and Baker, A.N. 1980. Age of reputedly old killer whale, *Orcinus orca*, 'Old Tom' from Eden, Twofold Bay, Australia. *Rep. int. Whal. Commn* (special issue 3): 143-54.
- Myrick, A.C., Yochem, P.K. and Cornell, L.H. 1988. Towards calibrating dentinal layers in captive killer whales by use of tetracycline labels. *Rit. Fisk.* 11:285-96.
- Nishiwaki, M. and Handa, C. 1958. Killer whales caught in the coastal waters off Japan for recent 10 years. *Sci. Rep. Whales Res. Inst., Tokyo* 13:85-96.

- Ohala, J.J. 1984. An ethnological perspective on common cross-language utilization of F_0 of voice. *Phonetica* 41:1-16.
- Olesiuk, P. and Bigg, M.A. 1990. Life history and population dynamics of resident killer whales (*Orcinus orca*) in coastal waters off British Columbia and Washington State. SC/A88/ID3 (published in this volume).
- Perrin, W.F. and Donovan, G.P. (eds.). 1984. Report of the workshop. *Rep. int. Whal. Commn* (special issue 6):1-24.
- Perrin, W.F. and Reilly, S.B. 1984. Reproductive parameters of dolphins and small whales of the Family Delphinidae. *Rep. int. Whal. Commn* (special issue 6):97-133.
- Sacher, G.A. 1980. The constitutional basis for longevity in the Cetacea: do whales and terrestrial mammals obey the same laws? *Rep. int. Whal. Commn* (special issue 3):209-13.
- Seber, G.A.F. 1982. *The Estimation of Animal Abundance and Related Parameters*. Charles Griffin & Co., London. 654pp.
- Sokal, R.R. and Rohlf, F.J. 1981. *Biometry*. Freeman and Co., New York. 859pp.
- Sumich, J.L. and Harvey, J.T. 1986. Juvenile mortality in gray whales (*Eschrichtius robustus*). *J. Mammal.* 67:179-82.
- Sweeney, J.C. 1977. Difficult births and neonatal health problems in small cetaceans. pp. 276-87. *In*: S.H. Ridgway and K. Benirschke (Eds.) *Breeding Dolphins: Present Status, Suggestions for the Future*. Report to the US Marine Mammal Commission #MMC 76-07.
- Waite, J.M. 1988. Alloprenatal care in killer whales (*Orcinus orca*). Master's Thesis. University of California, Santa Cruz.
- Walker, L.A., Cornell, L., Dahl, K.D., Czekala, N.M., Dargen, C.M., Joseph, B., Hsueh, A.J.W. and Lasley, B.L. 1988. Urinary concentrations of ovarian steroid hormone metabolites and bioactive follicle-stimulating hormone in killer whales (*Orcinus orca*) during ovarian cycles and pregnancy. *Biol. Repro.* 39:1013-20.

A Comparison of Photo-Identification Studies of California Coastal Bottlenose Dolphins

Larry J. Hansen

*NOAA/National Marine Fisheries Service, Southeast Fisheries Research Center,
Miami Laboratory, 75 Virginia Beach Drive, Miami, Florida 33149, USA*

R.H. Defran

*Cetacean Behavior Laboratory, Department of Psychology, San Diego State
University, San Diego, California 92182, USA*

ABSTRACT

Different resighting rates of bottlenose dolphins were obtained by the authors in separate photo-identification studies carried out in the coastal waters of north San Diego County, California. Specifically, a subset of one data set (1981–83) showed strong site fidelity to the area while the other (1984–86) contained no such evidence. In an attempt to integrate the data sets, possible methodological differences were evaluated, and the following conclusions were reached: (1) photo-identification procedures differed but both were judged equally effective in detecting resights; (2) survey effort did not contribute to resighting differences; (3) photographic efficiency was comparable for both studies. Thus, it appears that there was a real shift in the site fidelity patterns displayed by some dolphins within the study area. The El Niño event of 1982–83 occurred between the studies and probably precipitated or contributed to the apparent shift in site fidelity.

INTRODUCTION

In recent years, photographic studies have been used to enumerate various characteristics of cetacean population size, residency patterns, birth rates and other demographic features. Most of these studies have been carried out by individuals or groups working within limited geographic areas. Attempts to combine data sets from the same or adjacent populations collected by different researchers may pose problems of comparability. A necessary starting point to examine comparability is an assessment of the methods used to generate the data sets.

This paper considers a number of methodological features from two independent investigations of the Southern California population of coastal bottlenose dolphins (*Tursiops truncatus*) by the authors (Hansen 1981–83, Defran and colleagues 1984–86).

The most striking difference found between the data sets was in the resighting rates of individual animals. Some degree of site fidelity was evident in a sub-set of Hansen's data which suggested that the San Diego study area functioned as at least part of a home range for some dolphins (Hansen, 1990). In this respect the data were consistent with other studies of this species which provide evidence for year-round or seasonal home ranges (Shane, Wells and Würsig, 1986; Ballance, 1990; Shane, 1987; Wells, 1986). In contrast, Defran's data did not contain evidence for site fidelity (Defran, Kelly, Schultz, Weaver and Espinoza, in press).

An important ecological event, the El Niño of 1982–83, affected the study area (Halpern, Hayes, Leetmaa, Hansen and Philander, 1983) prior to the start of the Defran study period. Hansen (1990) and Defran *et al.*, (in press) interpreted the different resighting rates as evidence of El Niño induced changes in the distributional patterns of these dolphins, which were reported by Wells, Hansen, Baldrige, Dohl, Kelly and Defran (1990). In this paper, we compare methods of data collection and analysis between the two studies to examine the possibility that

differences in these, rather than the differences in distribution of the animals, may be responsible for the difference in the photographic resighting rate.

SUMMARY OF HANSEN'S AND DEFRAN'S METHODS AND DATA SETS

Information included in the summaries below was selected for its relevancy to an evaluation of photographic resighting rate. More comprehensive accounts are found in Hansen (1990) and Defran *et al.*, (in press).

Methods

Both Hansen and Defran used similar techniques for collecting photographs of bottlenose dolphins. The Hansen surveys were carried out from the southern to the northern end of the survey area (Fig.1) using a 4.9m outboard-powered Boston Whaler. Searching was conducted at about 22km/hr, approximately 90–180m offshore. When a group of dolphins was sighted, its size and structure were estimated and then photographs were taken from a distance of about 3–14m until it was felt that a good photograph of each dolphin had been obtained. Groups were observed and photographed for about 15–30 minutes. The photographs were taken with a 35mm Canon A-1 with a Canon 400mm f4.5 lens or a Canon 80–300mm f4.5 zoom lens; a motor drive was used at all times. Nearly all the photographs were taken with Kodachrome 64 film. The Defran surveys were almost identical but most photographs were taken with Tri-X and visual contact was maintained with the groups for longer periods (average=95 mins) in order to carry out behavioural observations as well as to photograph dolphins (Weaver, 1987).

Somewhat different methods were used for examining dorsal fin photographs. Hansen viewed photographic transparencies with a dissecting microscope and partitioned the dorsal fins into five equal sections. The fins

were then assigned a five-digit code according to the number of notches contained in the trailing edge of each section. Photographs of fins with the same or similar code were visually compared for possible matches. Defran's technique used tracings of dorsal fins made from projected negatives which were then coded according to a ratio of the distance between the two largest notches and the distance between the large bottom notch and the top of the fin (Defran, Shultz and Weller, 1990). As with Hansen's technique, photographs of fins with the same or similar codes were visually reviewed for possible matches. If a fin could not be matched with fins of the same or similar codes, both techniques required that it first be compared with all other possible matches before being declared unique.

Results of Hansen study

Between September 1981 and January 1983, 22 photographic surveys were conducted along the north San Diego County coast between Scripps Pier in the south and Oceanside in the north (Fig. 1). Fourteen of these surveys covered the entire study area (complete survey) and eight were of only a portion (partial survey). Dolphins were seen on 12 of the 14 complete surveys and on all partial surveys (91% encounter rate). A total of 37 groups of dolphins were seen and 123 individual dolphins were identified. Seventy-one (58%) of these recognisable dolphins were

seen more than once and 21 (17%) were seen 5 to 9 times. Of the later group, some were seen throughout the year while others were seen seasonally.

Results of Defran study

Between January 1984 and May 1986, 78 photographic surveys were conducted along the same coastal area surveyed by Hansen. Dolphins were seen on 25 of the 44 complete surveys and on all 34 partial surveys of the study area (77% encounter rate). A total of 61 groups of dolphins were seen and 215 individual dolphins were identified. Seventy-five (35%) of these recognisable dolphins were seen more than once and 5 (2%) were seen 5 to 7 times. Fifty-three percent of the dolphins previously identified by Hansen were photographed within the San Diego study area.

DIFFERENCES IN THE DATA SETS

Both data sets contained numerous recognisable individuals that were resighted only once (Hansen 42%, Defran 65%). However, Hansen's subset of frequently resighted animals (≥ 5 times) represented 30% of resighted dolphins and accounted for 65% of the resightings. In contrast, only 7% of Defran's animals were frequently resighted (≥ 5 times) and they accounted for only 10% of the resightings. The difference is even more pronounced if survey effort is compared; Defran had 2.4 times as many surveys with photographs ($n=48$) as did Hansen ($n=20$). Furthermore, only 11 of Hansen's frequently sighted subset ($n=21$) were subsequently photographed by Defran.

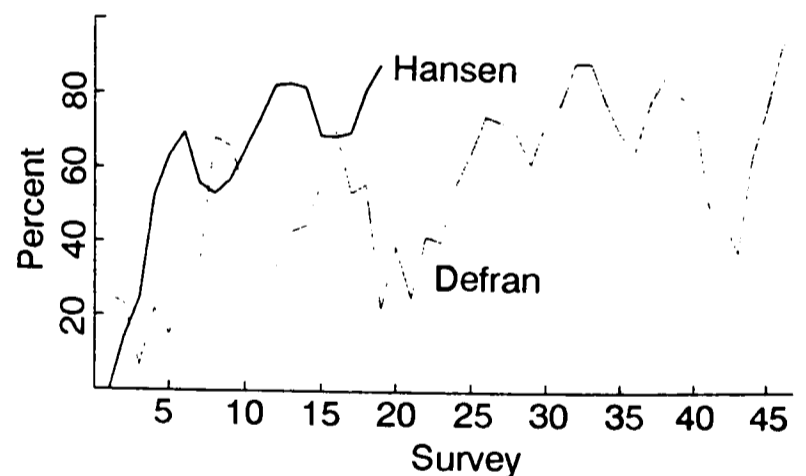

Fig. 2. Moving average of percentage of resighting rates and of new identification rates for Hansen and Defran data sets. Averages are percent resightings per survey by groups of 3 (current survey, and both adjacent surveys).

Although Hansen's overall percentage of animals resighted (58%) is considerably higher than Defran's (35%), despite the greater number of photographic encounters of the latter, the mean numbers of animals resighted *by survey* are similar (Hansen about 65%; Defran about 60%). Fig. 2 illustrates the moving average (by 3 surveys) of the number of animals resighted per survey and new sightings per survey. Both surveys show fluctuations in the number of resightings and new animals. However, whereas Hansen's data show a fairly rapid increase in resightings and decrease in new animals, Defran's data are less consistent and appear to show periodic influxes of new animals. This would of course tend to decrease Defran's overall resighting rate.

As another measure of the difference in resighting rates between the two data sets, for each individual sighted three or more times (Hansen=50, Defran=29) we derived a

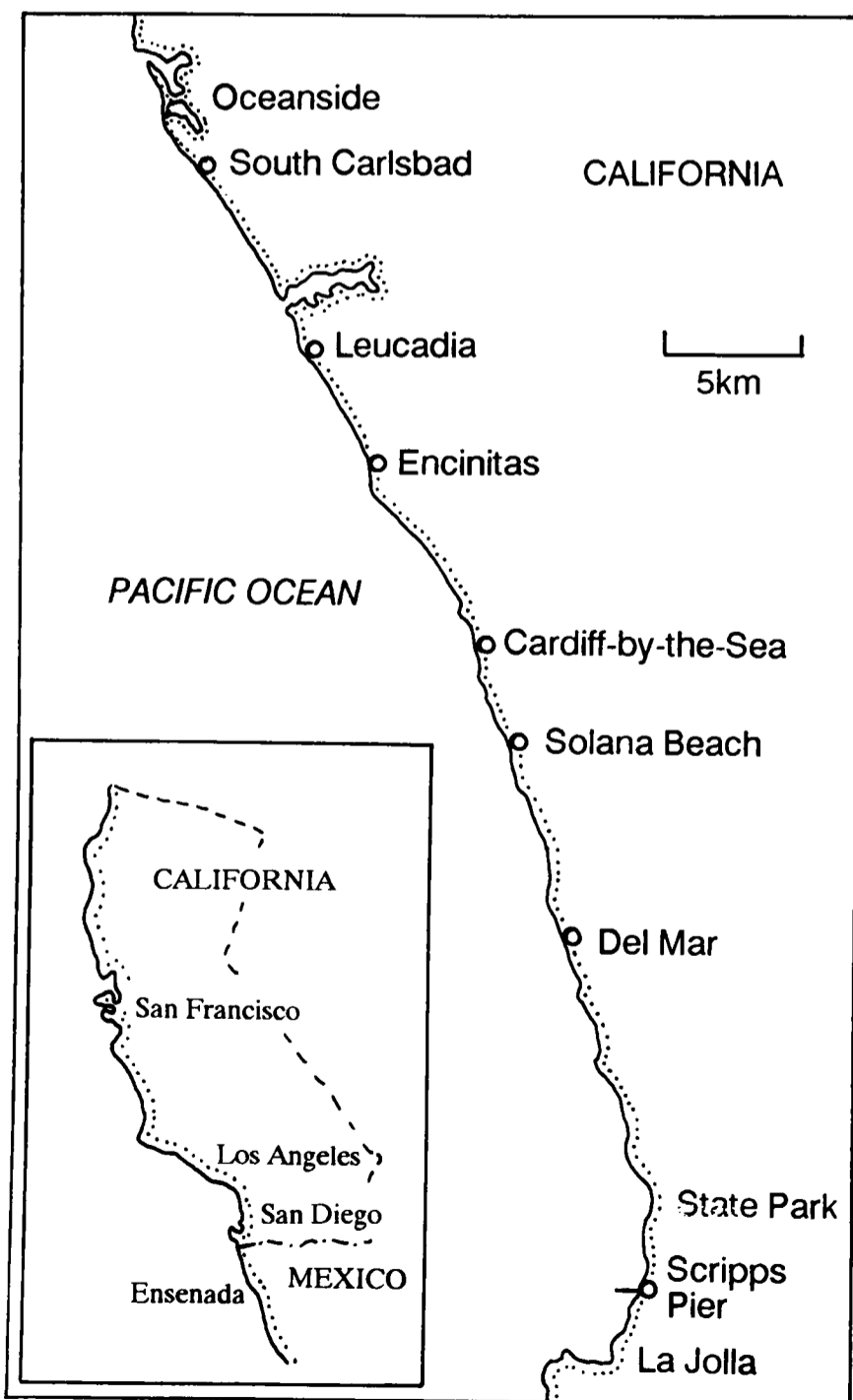

Fig. 1. Map of the San Diego Study Area. Insert is map of California and Northern Baja Mexico Peninsula.

score representing the numbers of sightings corrected for the opportunity (number of surveys) to be photographed. The mean Sighting/Opportunity (S/O) for this subset of Hansen's data set was 0.23, while for Defran's it was 0.08. A one-way between subjects ANOVA on the S/O scores was significant ($F_{(1-77)}=75.3$, $p=0.0001$).

METHODOLOGICAL COMPARISON AND EVALUATION

Survey methodology

Both investigations surveyed the same stretch of coast using similar boats and identical cameras and lenses. Photographs were collected in approximately the same manner. However, Hansen did spend less time observing dolphin groups.

The northern point of Hansen's study area extended to Oceanside Harbor (Fig. 1). However, the majority (89%) of Hansen's sightings occurred between Scripps Pier in the south and South Carlsbad State Beach in the north. South Carlsbad State Beach was designated as the northern limit of Defran's study area, which covered about 80% of Hansen's area. Could this reduced study area in Defran's investigation have resulted in missed identifications?

In fact, 16 of the 44 complete Defran surveys extended to Oceanside Harbor. This is similar to the total number of complete surveys ($n=14$) in Hansen's investigation. Analysis of sighting data from this subset of Defran's data reveals that dolphins were seen on 12 of the 16 surveys to Oceanside and as with Hansen's data, most dolphins were seen between Scripps Pier and South Carlsbad State Beach. Given that the study areas were similar in size and in the distribution of sightings, and that the effort in Defran's investigation was greater, we conclude that survey effort was not a contributing factor to the observed differences.

Photo-identification procedures

Although different techniques were used for analysing and organising dorsal fin photographs, in both studies the final decision regarding a resighting was made using an 8x eye loupe and/or a dissecting microscope. Furthermore, only clear photographs of distinctively notched fins were retained as 'recognisable dolphins'. Because the matches were ultimately made by the same method, it is reasonable to presume that any biases in finding matches were probably consistent and equal between the two techniques. Therefore, while these techniques may vary in convenience and implementation, we concluded that they were both effective, conservative and approximately equal in identifying possible resightings.

Photographic efficiency

In this section we attempt to evaluate the proportion of dolphins seen on a survey to those captured on film, to examine whether differences in 'efficiency' could have produced differences in resighting rates.

An estimate of the size of the groups photographed is necessary for estimating photographic efficiency. However, group size estimates were made differently in the two investigations. Hansen's estimate of group size (S) was based on the number of animals appearing in his photographs and was calculated by the formula:

$$S=R + u/r$$

where R = number of recognisable animals photographed, u = number of photos of unrecognisable animals and r = mean number of photos of recognisable animals.

The estimate was thus actually an estimate of the total number of animals (recognisable and unrecognisable) photographed rather than the group size. By contrast, Defran made field estimates of group size. Neither technique includes a ground-truth reference and both techniques may be vulnerable to bias, albeit of different and possibly indeterminate types.

One measure of the efficiency of obtaining photographs of a group of dolphins is the proportion of 'recognisable' animals identified to the estimated herd size. Overall, Hansen reported identifying 74% of the dolphins photographed while Defran estimated that only 41% of the dolphins seen were identified. Assuming Hansen's estimate represents the percentage of recognisable fins available, and that calves are not easily photographed, the best estimate of photographic efficiency (P) for Defran's surveys can be calculated as:

$$P=R/0.74(g - 0.095g)$$

where g = field estimate of dolphins seen and 0.095g = number of calves in the population estimated by Defran.

If the assumptions are correct, P thus represents an estimate of the number of non-calf animals identified out of those which are identifiable. The mean of these calculations for the 48 Defran surveys with photographs results in a P of 0.62. This value indicates that, particularly given Defran's greater survey effort, his data should provide a more than adequate sample of the recognisable dolphins and that photographic efficiency was probably adequate in his investigation. Hansen did make field estimates of group size, but not necessarily as thoroughly and consistently as Defran. The application of this formula to Hansen's data produces misleading results, especially since R (number of recognisable animals photographed) was greater than g for about 32% of the groups seen.

Because our methods of estimating school size differed, it was not possible to obtain directly comparable estimates of photographic efficiency. However, we have found no *a priori* or retrospective basis for concluding that photographic efficiency differed in the investigations. Furthermore, even if Defran's efficiency was lower, this should have been compensated for by the greater effort. Therefore, we believe that our two data sets are directly comparable.

COMPARISON OF ABUNDANCE ESTIMATES

In order to test the assumption that a change in the distribution patterns or an increase in abundance of the dolphins might have resulted in Defran's low rate of multiple-resightings, we compared the mark-recapture estimates obtained by Hansen (1990) with an estimate made from the Defran data set. Hansen (1990) used a variety of mark-recapture estimators, including Schnabel's method (Schnabel, 1938), which resulted in population estimates ranging from 173–240 animals. A population estimate for Defran's data was also made using Schnabel's method, which resulted in an estimate of 1,418–1,686 animals. This 6–10 fold difference in estimates supports the hypothesis that the distribution and/or abundance of dolphins changed between the two studies. That is, more animals could have been moving through the study area, and also spending less time in the area and returning to the

area less often. Defran's low resighting rate and the apparent frequent influx of new animals during Defran's study (Fig. 2) tends to support this view.

DISCUSSION

We have examined the methods used in the Hansen and Defran studies, and have concluded that while there were differences in methodologies, they were generally minor and should not have caused the observed differences in the data sets. We believe that the differences between the data sets, especially in the site fidelity patterns, the resighting rates and abundance estimates, were caused by changes in biological parameters and lend support to our view that the 1982 El Niño may have caused changes in the distribution and abundance of dolphins along the eastern north Pacific coastline including the San Diego study area. The El Niño began in the central and western Pacific in July 1982 and spread to the eastern Pacific where major effects occurred during late 1982 and 1983 (Halpren *et al.*, 1983). Hansen's study was almost complete before the El Niño affected the study area; 86% of his photographic surveys took place before November 1982. Similarly, the El Niño, but not necessarily its lasting effects, was over before Defran's investigations were initiated. The site fidelity exhibited by some of the dolphins during Hansen's study may have been disrupted or at least altered by the El Niño.

Wells *et al.*, (1990) have summarised data on central and northern California coastal bottlenose dolphin photographic, land-based and aerial survey data collected post-El Niño. A number of dolphins photographed by Hansen in San Diego were photographed much further north in the Santa Cruz area (37°N) and subsequently by others in southern California, including within the San Diego study area. Prior to the 1982-83 El Niño, coastal bottlenose dolphins have not been noted, in modern times, further north than Los Angeles, which is several hundred kilometers south of Santa Cruz. Wells *et al.* (1990) hypothesise that some dolphins inhabiting the northern portion of their Pacific coast range may use such warm-water events to exploit new areas.

The changes in abundance and distribution caused by ecological events such as El Niño may contribute to and exploit the 'behavioral flexibility' (Shane, 1987) of this species. Therefore, it appears that the timing of our investigations, and, as shown in this paper, their comparability, permitted a unique opportunity to document the shifts in abundance and distribution associated with this most recent El Niño event. We recommend that other investigators seeking to compare and integrate photo-identification data sets follow a similar

line of approach to ours, and further recommend that, in the future, consistent field methodologies be used so that observed variability can be attributed to changes in biological parameters rather than methodological differences.

ACKNOWLEDGEMENTS

Numerous people contributed to the field activities involved in both of the studies. Hansen's field studies were funded by the Southwest Fisheries Center (SWFC). In addition to support from the College of Sciences, San Diego State University, Defran's field activities were also partially supported by the SWFC. Drs. Joseph E. Powers and Gerald P. Scott of the Southeast Fisheries Center, Miami, Florida, and two anonymous reviewers reviewed and improved the manuscript. The National Marine Fisheries Service does not approve, recommend or endorse any proprietary product or proprietary material mentioned in the publication.

REFERENCES

- Ballance, L.T. 1990. Residence patterns, group organisation, and surfacing associations of bottlenose dolphins, *Tursiops truncatus*, in the Gulf of California, Mexico. pp. 267-83. In: S. Leatherwood and R. Reeves (eds) *The Bottlenose Dolphin*. Academic Press, San Diego. 653pp.
- Defran, R.H., Shultz, G.M. and Weller, D.W. 1990. A technique for the photographic identification and cataloging of dorsal fins of the bottlenose dolphin, *Tursiops truncatus*. Paper SC/A88/P4 (published in this volume).
- Defran, R.H., Kelly, D.L., Shultz, G.M., Weaver, A. Ch. and Espinoza, M.A. 1990. Occurrence and movements of the bottlenose dolphin (*Tursiops truncatus*) in the Southern California Bight. *Mar. Mammal Sci.* (in press).
- Halpren, D., Hayes, S.P., Leetmaa, A., Hansen, D.V. and Philander, S.G.H. 1983. Oceanographic observations of the 1982 warming of the tropical eastern Pacific. *Science* 221:1173-1175.
- Hansen, L.J. 1990. California coastal bottlenose dolphins. pp.403-20. In: S. Leatherwood and R. Reeves (eds) *The Bottlenose Dolphin*. Academic Press, San Diego. 653pp.
- Shane, S.H., Wells, R.S. and Würsig, B. 1986. Ecology, behavior and social organisation of the bottlenose dolphin: A review. *Mar. Mammal Sci.* 2:34-63.
- Shane, S.H. 1987. The behavioral ecology of the bottlenose dolphin. Ph.D. Dissertation. University of California, Santa Cruz. 97pp.
- Weaver, A.C. 1987. An ethogram of naturally occurring behavior of bottlenosed dolphins, (*Tursiops truncatus*), in Southern California waters. M.A. Thesis. San Diego State University, San Diego, CA 203pp.
- Wells, R.S. 1986. Structural aspects of dolphin societies. Ph.D. Dissertation. University of California, Santa Cruz. 234pp.
- Wells, R.S., Hansen, L.J., Baldrige, A.B., Dohl, T.P., Kelly, D.L. and Defran, R.H. 1990. Northward extension of the ranges of bottlenose dolphins along the California coast. pp. 421-31. In: S. Leatherwood and R. Reeves (eds) *The Bottlenose Dolphin*. Academic Press, San Diego. 653pp.

Changes in the Ventral Fluke Pattern of the Humpback Whale (*Megaptera novaeangliae*), and its Effect on Matching; Evaluation of its Significance to Photo-Identification Research

Carole A. Carlson and Charles A. Mayo

Center for Coastal Studies, Provincetown, MA 02657, USA

and Hal Whitehead

Biology Department, Dalhousie University, Halifax, NS B3H 4J1, Canada

ABSTRACT

The most distinctive individual variation in pigment patterns of the humpback whale (*Megaptera novaeangliae*) are found on the ventral surface of the flukes. Research conducted from 1978–86 on a seasonally-returning population of humpback whales of the Gulf of Maine indicates that this pattern is not stable in some individuals. Of 152 whales identified in this study, 4.6% showed a major fluke pattern change; 31.8% a moderate change; and 63.6% showed little or no change. In extreme cases of change, errors may be expected in the matching of fluke pattern photographs of young animals separated by as little as one year. Results of tests designed to evaluate the effects of such change on matching success indicate the degree of fluke change for all whales varied significantly with coloration – darker flukes showing the greatest amount of change. The most dramatic pigment change occurred during the first year of a calf's life. More matching errors were made on photographs of the same whale where moderate and major fluke changes were a factor and on different whales with all white flukes. More experienced individuals made fewer mismatches and the number of matching errors was inversely proportional to the amount of time spent on matching. The probability of an experienced matcher not making a match in the population was less than 0.01. When applying this to mark-recapture estimates using the Petersen technique, an important use of photo-identification data, the bias for the most experienced matchers was less than 1%. The bias, specific for the southern Gulf of Maine catalogue of 216 individual whales, would tend to be greater for larger catalogues.

INTRODUCTION

The method of identifying individuals by recording variations in natural marks has successfully been used to study several cetacean species, including killer whales (Bigg, 1982), gray whales (Darling, 1977), right whales (Payne, Brazier, Dorsey, Perkins, Rowntree and Titus, 1983), sperm whales (Whitehead and Gordon, 1986), blue whales (Sears, 1984), minke whales (Dorsey, 1983) and humpback whales (Katona and Kraus, 1979).

The humpback whale (*Megaptera novaeangliae*) has a number of morphological features which make it particularly easy to study. The most significant of these is the difference in pigmentation patterns on the ventral surface of the flukes. Other characteristics such as dorsal fin shape, scarification and serration of trailing edges of the flukes aid in the identification of individuals (Schevill and Backus, 1960; Katona and Whitehead, 1981; Mayo, 1982).

The fact that individuals can be identified in the field and their identities confirmed by photographs is the key to detailed studies of population size and dynamics (Herman and Antinaja, 1977; Whitehead, 1982; Whitehead, Chu, Perkins, Bryant and Nichols, 1983; Baker, Herman, Perry, Lawton, Straley, Wolman, Kaufman, Winn, Hall, Reinke and Ostman, 1986; Katona, 1986; Darling and Morowitz, 1986), seasonal return rate (Mayo, 1982; Glockner-Ferrari and Ferrari, 1984), temporal and spatial distribution (Whitehead, Harcourt, Ingham and Clark, 1980; Herman and Antinaja, 1980; Baker and Herman, 1981; Mayo, 1982; Darling and Jurasz, 1983), social organisation (Whitehead, 1983) and the calving rate (Glockner-Ferrari and Ferrari, 1984; Baker, Perry and Herman, 1987; Clapham and Mayo, 1987) of this species.

Determination of the stability of these features and their reliability for individual identification is of critical importance to many aspects of humpback whale research.

In this study we investigate the frequency and degree of change in the pigmentation of the ventral fluke pattern of individual humpback whales in the waters of the western North Atlantic. We also present the results of tests that were designed to assess the effects of such changes on the photographic matching of individuals.

METHODS

Data collection and photographic files

The information presented in this report was derived from observations at sea in the vicinity of Cape Cod, Massachusetts. The majority of the photographs of individual whales examined in this study were taken aboard the 30m commercial whalewatching vessels *Dolphin III, IV, V, VI* and *VII* and the 12m R/V *Halos* from 1978–86. During this period approximately 5,000 cruises were conducted. Each individual whale photographed was given a name based on a distinctive field mark observed on its body or flukes. This procedure was initiated as a mnemonic device to aid in data collection. File codes for computer processing were assigned to each individual using the first two letters of the name and a number.

Photographs were taken using *Pentax ME* and *MX* cameras and *Pentax* lenses ranging from 28–400mm, with skylight filters. Each camera body was equipped with a *Pentax 2–5* frame/second power winder for sequential photographs, and a recording data back for coding individual observations. *Kodak Tri-X* and *Ilford HP5* black and white film (both rated at ISO 400) was used.

Contact sheets of all negatives were printed and analysed. Each frame was labelled with the name of known individual humpbacks; previously undocumented individuals were assigned a numeric code. Clear,

well-focused photographs exhibiting the identifying marks of each individual were selected from each contact sheet to add to the established photographic data base. The Cetacean Research Program files of over 450 individually identified humpback whales were screened for examples of pigmentation changes. Many of the photographs selected were taken over a 6 year period specifically for this study.

Analysis of fluke change

The fluke patterns of individual humpback whales photographed from 1978–86 were examined for evidence of pigment change. The 152 whales photographed in more than one year were ranked in one of the following categories: (1) little to no change in pattern over sighting history; (2) moderate change in pattern (a pigment change which does not change the fluke colouration number: described below); and (3) major change in pattern (a dramatic change which does change the fluke colouration number). Photographs illustrating the three categories are given in Fig. 1.

A work sheet was prepared listing the following parameters for each individual whale: year of birth (when known); year first observed; sex when known; year first

sighted with calf (for evidence of maturity); fluke change over one year period for each year sighted; fluke colouration number (1=all white; 2=some black but less than 25% black; 3=25–75% black/25–75% white; 4=some white but less than 25% white; 5=all black); total fluke change over sighting history (ranked 1–3, as above). Fig. 2 shows examples of the categories of fluke colouration listed above.

All whales were listed by degree of fluke change as well as by sex and fluke colouration. In order to examine the significance of the relationships between sex and colouration and fluke change, and the significance of sex to fluke colouration, chi-squared contingency table tests were used.

A calf was defined as a whale whose length was judged to be half or less than that of the accompanying whale, presumed to be its mother. A calf is generally observed in close association and in behavioural synchrony with a particular adult whale. Fluke change rankings by sex (when known), fluke colouration and degree of change over time (in years) were listed for thirty-three whales first seen as calves. The relationship between age and fluke change was tested using a chi-square contingency table test.

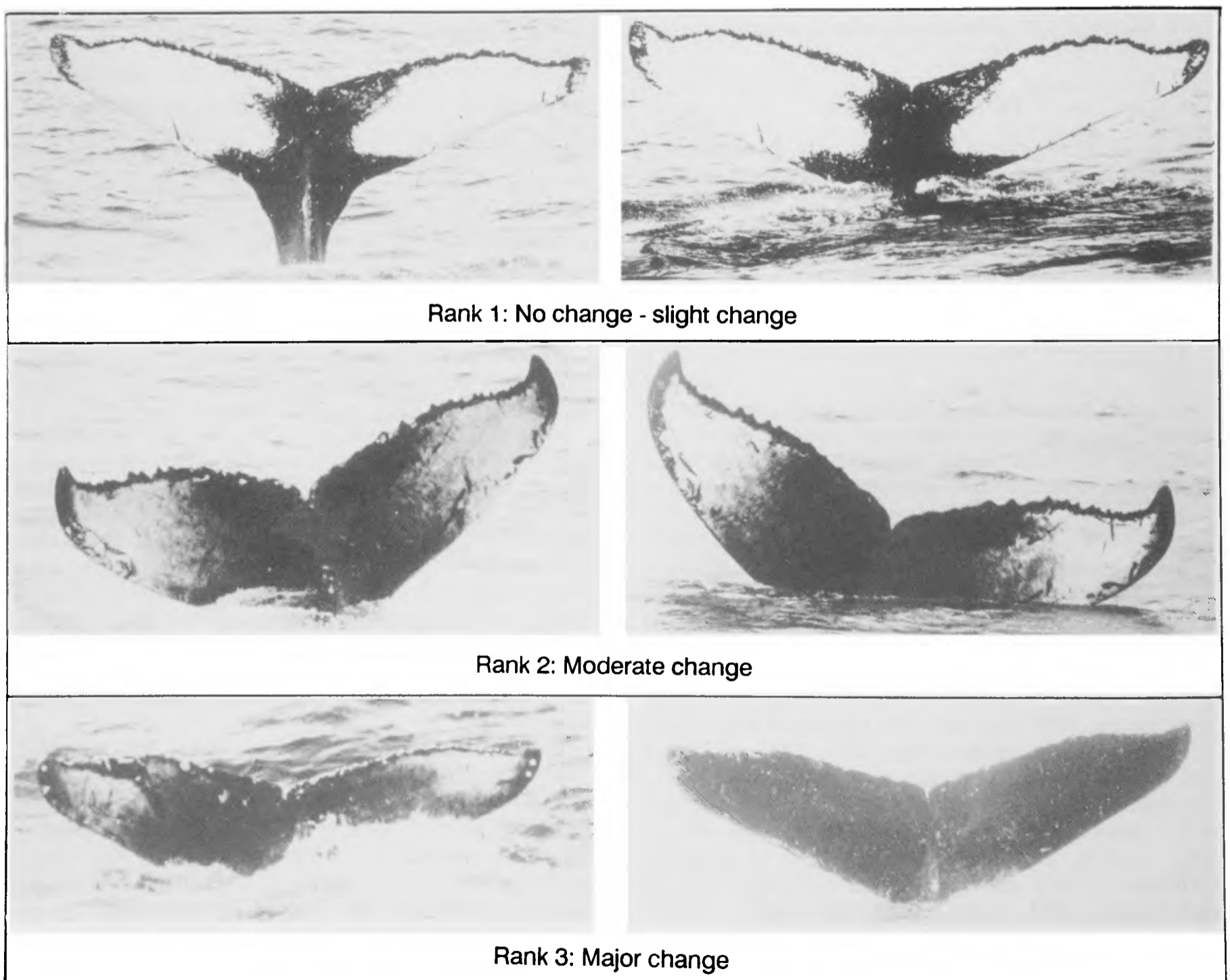

Fig. 1. Ranking of fluke change.

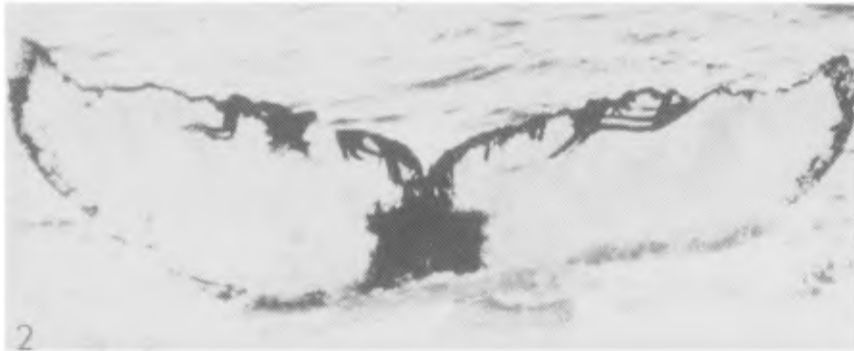
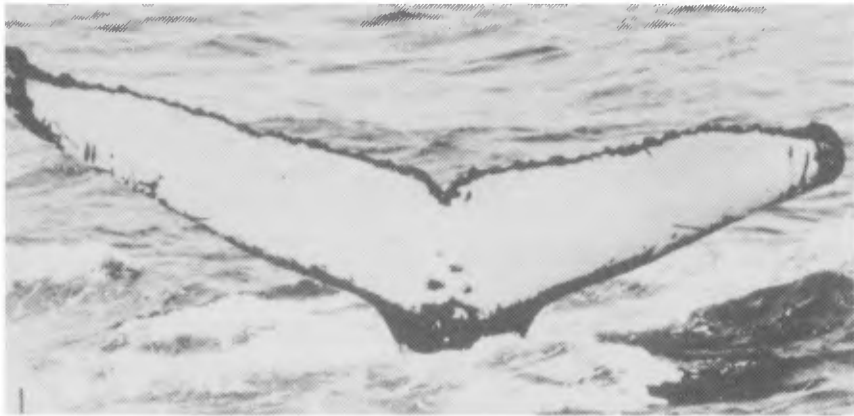

Fig. 2. Categories of fluke type.

Test to evaluate categories of fluke change

Paired photographs of the fluke patterns of 25 individual humpback whales were randomly chosen from a set of photographs of the 152 whales whose fluke patterns were ranked in the fluke change categories – nine each from categories 1 and 2 and seven from category 3.

These photographs were placed randomly on a working surface. Twenty volunteers (from the Center for Coastal Studies and Dalhousie University) were asked to rank the photo set from the individual whale whose pattern changed the least or not at all, to the individual whale whose pattern exhibited the greatest amount of change. Mean values of these assigned ranks were calculated for each individual whale, and are compared with the original ranks (assigned by Carlson).

Test to rank fluke changes of twenty-five individual humpback whales

The correlation of the ranking of paired photographs by each volunteer with the original rank (Carlson) was determined using a Spearman's Rank Correlation Coefficient test.

Matching test

In order to test the effect of fluke change on matching success, 100 paired photographs of the ventral flukes of humpback whales were compiled. The pairs included photographs of: (1) all categories and time frames of pattern changes from the same individual; (2) distinctively different individuals; (3) similar but different individuals; and (4) identical photographs.

Random numbers from 1 to 100 were generated to determine the order in which the pairs would be presented. Copies of the paired photographs were sent to 107 members of the North Atlantic Marine Mammal Association and to 30 professors and graduate students of the Biology Department at Dalhousie University. All participants were asked to determine whether the paired photographs represented the same or different individual whales. The matchers were also asked to record the time spent on the test.

One hundred and twelve (112) answer sheets were returned. These were coded for experience of matcher and time spent on matching. Each answer was given a numerical code before the data were entered into a computer. Experience, time and answer codes are defined and listed in Table 1. The number of participants by categories of experience and time spent on matching as well as the mean number of incorrect answers for all categories were calculated. The significance of time and

Table 1

Codes for categories of experience, time spent matching and answers.

Experience codes

- (1) matcher: humpback whales
- (2) matcher: other cetaceans
- (3) marine mammal researcher
- (4) other

Time spent matching codes (in minutes)

- (1)0-30 (2)31-60 (3)61-90 (4)91-120 (5)121-50 (6)151-80 (7)181-210

Answer codes

Code	Answer given	Correct	Code	Answer given	Correct
(0)	same	same	(2)	same	different
(1)	different	same	(3)	different	same

experience in relation to the degree of matching error was determined by using a chi-squared contingency table test. The number of correct and incorrect answers for each of the 100 pairs of photographs was tabulated.

Matching error: not making a match

The occurrence of matchers not making a match of two photographs of the same whale taken one year apart based upon the degree of fluke change and the experience of the matcher was calculated. This was defined as $K(i, j)$, the total number of matches not made, divided by the total number of possible matches, for fluke change category i and matcher experience j . Then, the probability of not making a match in the population of two photographs of the same whale taken one year apart is:

$$p_1(j) = \sum p(i) K(i, j)$$

where $p(i)$ is the total number of fluke changes in category i divided by the total number of all fluke changes in all categories, over one year, and the population is defined as the 152 animals used in this study.

Matching error: making an incorrect match

All 100 pairs of photographs from the matching test were placed in one of the following five categories of fluke type:

- (1) *very different*=flukes more than three pages apart in Mayo, Carlson, Clapham and Mattila's (1985) humpback whale catalogue (flukes in this catalogue were ordered from all white to all black);
- (2) *slightly different*=flukes one to three pages apart;
- (3) *black*=black flukes;
- (4) *white*=white flukes;
- (5) *black/white*=flukes with similar amounts of both black and white colouration.

The occurrence of incorrect matches for each of the five fluke type categories by experience of matchers was defined as $L(i, j)$, the total number of incorrect matches divided by the total number of paired fluke photographs, in fluke category i for matcher experience j .

A total of 216 flukes of whales of the southern Gulf of Maine from Mayo *et al.*'s (1985) humpback whale catalogue were randomly paired. The 108 randomly paired flukes were placed in one of the five categories listed above. Then the probability that a fluke photograph was wrongly matched with an incorrect partner was estimated from

$$p_2(j) = \sum q(i) L(i, j)$$

where $q(i)$ =total number of paired photographs in category i divided by the total number of paired photographs in all categories.

Bias in Petersen population estimates

The rates at which true matches were not made (probability of not making match in population, p_1) and the rate at which different whales were wrongly matched (probability of incorrect match in population, p_2) were used to estimate the bias in a Petersen estimate of abundance based on two samples taken one year apart. If M individuals are photographed in the first year and n in the second, with m common to the two years, then the expected number of matches, e , made is:

$$e = m(1-p_1) + (n-m)p_2.$$

The expected proportional bias in the Petersen population estimate is approximately given by: $(m-e)/e$. This was

estimated for each category of matcher experience for a range of values of the number of animals in the second sample (n) per reidentification (m).

RESULTS

Analysis of fluke change

The degree of fluke change for all whales (Table 2) varied significantly with colouration (chi-square=42.45, $df=8$, $p<0.001$) with more change in intermediate coloured flukes and with sex (chi-square=32.16, $df=2$, $p<0.001$) with more change in males. When fluke colouration by sex of individual whale was tested (Table 3), results indicated a significant difference between males and females with females showing generally darker flukes (chi-square=15.21, $df=3$, $p<0.005$).

Table 2

Degree of fluke change of 152 humpback whales.

Change:-	Rank 1 (little to none)	Rank 2 (moderate)	Rank 3 (major)	Total
<i>All Whales</i>	97	48	7	152
<i>Gender</i>				
Female	48	23	4	75
Male	22	20	2	44
<i>Colouration</i>				
1	4	0	0	4
2	24	10	0	34
3	53	27	1	81
4	7	8	6	21
5	12	0	0	12

Table 3

Fluke colouration (as shown in Fig. 2) listed by gender.

Coloration:	1+2	3	4	5	Total
Female	10	42	12	7	71
Male	18	26	1	1	46

The degree of fluke change of 33 calves (Table 4) varied significantly with colouration (chi-square=16.19, $df=4$, $p<0.005$); darker flukes showing the greatest amount of change. The relationship between age of individual calves and the degree of change was highly significant (chi-square=38.94, $df=6$, $p<0.001$); the most dramatic changes occurred during the first year, moderate change continued through the second year and little to no change occurred during the third and fourth year (Table 4).

Tests to evaluate categories of fluke change and rank 25 humpback whales

In the evaluation of categories of fluke change, 20 volunteers agreed on the categories of change in which the flukes of the 25 whales fell. The treatment of data using Spearman's Rank Correlation Coefficient test (Table 5) shows a high and significant correlation in the assessment of the ranked photographs between the rankers and an experienced matcher with those with more experience in photo-identification work showing generally higher correlations.

Table 4

Degree of fluke change of 33 humpback whale calves.

Change:-	Rank 1 (little to none)	Rank 2 (moderate)	Rank 3 (major)	Total
<i>All calves</i>	5	23	5	33
<i>Gender</i>				
Female	2	6	3	11
Male	2	14	2	18
<i>Colouration</i>				
1	0	0	0	0
2	1	8	0	9
3	4	13	1	18
4	0	2	4	6
5	0	0	0	0
<i>Age/Years</i>				
0-1	6	19	2	27
1-2	16	10	0	26
2-3	18	0	0	18
3-4	13	0	0	13

Table 5

Correlation of ranking by volunteers of 25 humpback whales with experienced matcher (CC).

Description of 'Ranker'	Corr. Coef.
Humpback whale researcher (ID), COA, CCS	0.9419
Intern, CCS	0.9412
Intern, CCS	0.9262
Humpback whale researcher (habitat), CCS	0.9254
Humpback whale researcher (director), CCS	0.9212
Humpback, sperm whale researcher, Dal.U.	0.9107
Fin whale researcher (ID matcher), CCS	0.8962
Admin, assistant, CCS	0.8946
Plankton researcher, Dal. U.	0.8566
Sperm whale researcher (ID), Dal. U.	0.8226
Intern, CCS	0.8123
Sea urchin researcher (pop.biol.), Dal.U.	0.7810
Biochemist, Dal.U.	0.7631
Environmental activist, Dal.U.	0.7576
Biology honours student, Dal. U.	0.7185
Fish pop. biologist, Dal. U.	0.6969
Bacteriologist, Dal.U.	0.6515
Beluga whale researcher (acoustic), Dal.U.	0.6123
Intern, CCS	0.5927
Physiologist, Dal.U.	0.5676

Matching test

The various categories of paired photographs, the number of pairs in each category and the mean number of correct answers by category are listed in Table 6. Mean scores indicate that more errors were made on pairs of photographs of the same whale where moderate and major pigment changes were a factor and on photographs of different individuals with white flukes.

Matching errors varied significantly with experience (chi-square=88.47, df=3, p<0.001) and with time spent on matching (chi-square=70.74, df=4, p<0.001) (Fig. 3). No correlation was found between the experience of the matcher and the time spent on matching. More experienced individuals made fewer mismatches and the number of matching errors (for all matchers) was inversely proportional to the amount of time spent on matching.

The occurrence of matches not being made and the probability of not making a match in the population are shown in Table 7. The probability of not making a match in

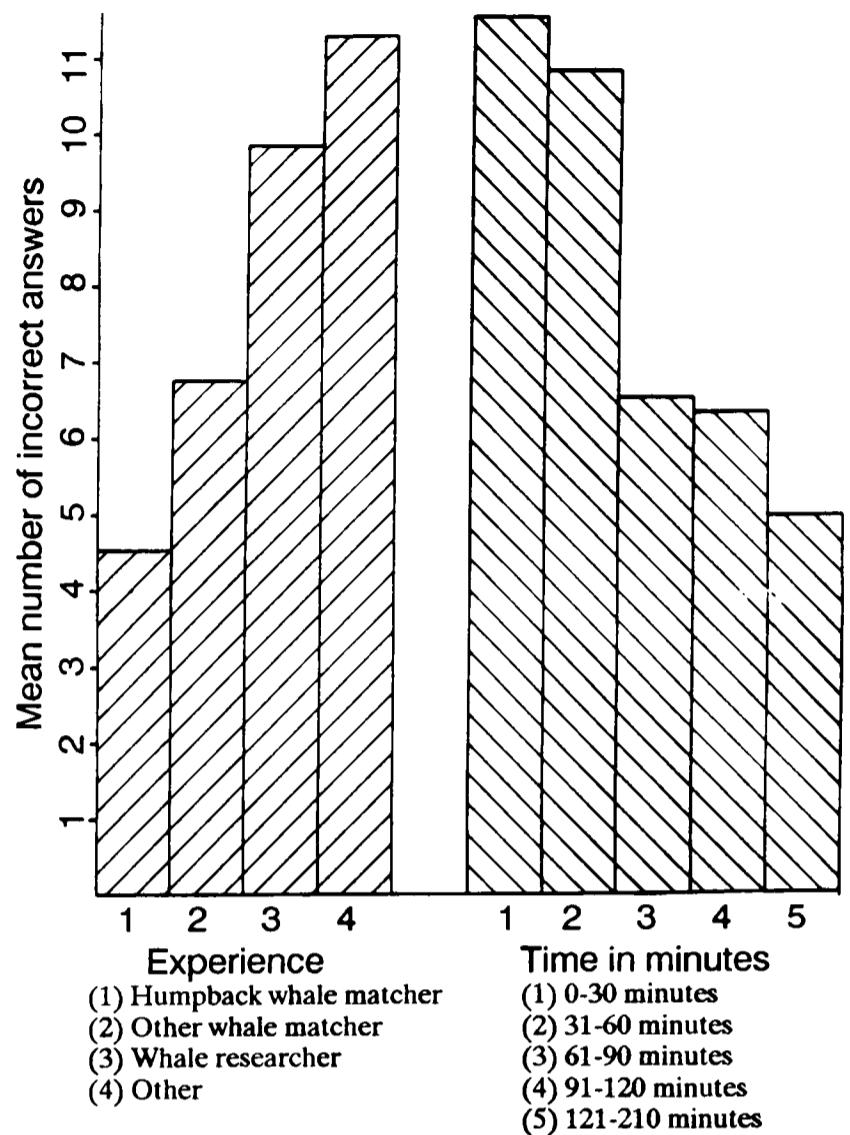

Fig. 3. Mean number of errors by experience group and time spent matching.

Table 6

Breakdown of categories of paired fluke photographs from matching test and matching success by category.

Matching fluke pair	No. of pairs	No. of correct answers	Total no. answers	Matching success
<i>Same whale</i>				
slight to no change	28	2752	3136	0.878
moderate change	31	2735	3472	0.788
major change	13	854	1456	0.587
<i>Different whale</i>				
black-white	4	372	448	0.830
black-white	5	451	560	0.805
white-white	3	259	336	0.771
b/w-b/w	16	1450	1792	0.809

the population of paired photographs is inversely proportional to the level of experience and less than 0.01 for experienced matchers. The probability of making an incorrect match in the population (matching photographs of two different individuals) is less for experienced matchers (0.005) and higher for less experienced individuals (Table 7).

Proportional bias in Petersen population estimate

Table 8 gives the approximate bias for different values of n/m and different categories of matcher experience. For the most experienced matchers, the bias is less than 1% if more than one fifth of the animals photographed the second year were also photographed the first. For less experienced matchers the situation is less optimistic. These

Table 7

Occurrence and probability of matching errors.

Experience	Change:	Rank 1	Rank 2	Rank 3	P_1
1		0.0030	0.0440	0.2175	0.0075
2		0.0033	0.0867	0.2833	0.0135
3		0.0085	0.1000	0.3407	0.0209
4		0.0097	0.1215	0.3181	0.0233

Experience	Fluke:	Rank 1	Rank 2	Rank 3	Rank 4	Rank 5	P_2
1		0.0000	0.0041	0.0178	0.0451	0.0300	0.0053
2		0.0154	0.0069	0.0000	0.0458	0.0064	0.0110
3		0.0685	0.0500	0.0981	0.1617	0.0800	0.0649
4		0.0902	0.0893	0.1168	0.2570	0.1200	0.0951

Note: p_1 and p_2 are average probabilities.

See text for the Experience, Change and Fluke categories.

Table 8

Proportional bias in Petersen population estimates by experience of matcher, for a range of values of number of animals in the second sample (n) per reidentification (m).

n/m	Category of Experience			
	1	2	3	4
1	0.0076	0.0137	0.0213	-0.239
2	0.0022	0.0025	-0.0421	-0.0670
4	-0.0083	-0.0191	-0.1418	-0.2076
8	-0.0287	-0.0597	-0.3024	-0.3911
16	-0.0672	-0.1316	-0.4879	-0.5839
32	-0.1355	-0.2467	-0.6657	-0.7452
64	-0.2461	-0.4046	-0.8027	-0.8565

estimates are specific to the southern Gulf of Maine catalogue. The bias would tend to be higher with larger catalogues.

DISCUSSION

The information presented represents a preliminary analysis of fluke pigment changes of 152 individual humpback whales. Comparisons of the representativeness of the 152 whales chosen for this study to the 216 whales in Mayo *et al.*'s (1985) southern Gulf of Maine catalogue showed no significant difference between the percentage of males and females or the percentage of whales in each fluke colouration category (Fig. 1).

The changes, while generally low in occurrence (of the 152 whales in this study, 4.6% showed a major fluke pattern change, 31.8% a moderate change and 63.6% little or no change), are representative of the southern Gulf of Maine catalogue. Matching errors associated with these changes would tend to be higher for larger populations and must be considered when applying photo-identification techniques to population studies. Also, the analysis probably underestimates the rate of failing to make matches as it is almost certainly harder to make a match with a whole catalogue than to decide whether a pair of photographs are similar.

The separation of calves from all other whales in this study indicates that 15.15% of calves showed a major change, 69.7% a moderate change and 15.15% little or no

change. Young whales with darker flukes exhibited the most dramatic change; the greatest degree of change occurring during the first two years of life. Our data indicate that particular attention in the analysis of humpback whale flukes must be paid to younger whales.

Although the probability of an experienced matcher not making a true match is less than 0.01, the probability increases when considering only calves (Tables 4 and 8). An error of this magnitude could be important if estimates of calf survival rates are obtained using photo-identification data. In some cases, the change in fluke pattern was minor between any two consecutive years while the cumulative change over several years was moderate or major. The cumulative changes represent a more serious consideration for larger catalogues or areas where the research effort is not consistent from season to season. It is therefore recommended that parameter estimates based on photographs of calves use populations that are intensively and annually studied.

The bias in the Petersen population estimate for the most experienced matcher (Table 8) would increase with the number of animals in the population and with a decrease in the percentage of animals photographed the second year that were photographed the first. Therefore, in large populations, especially in the initial stages of study, there may be a tendency to underestimate the population by matching fluke photographs of whales that are not true matches.

In summary, the ability to recognise changes in fluke patterns over time and to estimate its effects on matching through long-term studies of seasonally returning individuals lends support to the validity of the technique that has been used to identify humpback whales. With application of appropriate techniques (e.g. Katona *et al.*, 1980), the photo-identification of humpback whales will continue to provide valuable information on the distribution, migration, abundance, reproduction and social structure of this species.

ACKNOWLEDGEMENTS

The authors would like to thank Gordon Waring, Tim Smith and Tom Polachek of the National Marine Fisheries Service, Northeast Center for their helpful suggestions and comments on this study, Phil Clapham of the Center for Coastal Studies and Steve Katona of Allied Whale for critical review and suggestions on the manuscript and Harriet Corbett of Allied Whale for graphics. Thorvaldur Gunnlaugsson, Greg Donovan and Phil Hammond also made useful comments on the manuscript. We are indebted to Al and Aaron Avellar, and the captains and crew of the Dolphin Fleet, whose assistance made this study possible. This work was supported by the National Marine Fisheries Service, Northeast Center, Contract 40EANF702183 and the International Wildlife Coalition, Falmouth, MA.

REFERENCES

- Baker, C.S. and Herman, L.M. 1981. Migration and local movement of humpback whales through Hawaiian waters. *Can. J. Zool.* 59: 460-9.
- Baker, C.S., Herman, L.M., Perry, A., Lawton, W.S., Straley, J.M., Wolman, A.A., Kaufman, G.D., Winn, H.E., Hall, J.D., Reinke, J.M. and Ostman, J. 1986. Migratory movement and population structure of humpback whales (*Megaptera novaeangliae*) in the central and eastern North Pacific. *Mar Ecol. Prog. Ser.* 31: 105-119.

- Baker, S.C., Perry, A. and Herman, L.M. 1987. Reproductive histories of female humpback whales *Megaptera novaeangliae* in the North Pacific. *Mar. Ecol. Prog. Ser.* 41: 103-114.
- Bigg, M.A. 1982. An assessment of killer whales (*Orcinus orca*) stocks off Vancouver Island, British Columbia. *Rep. int. Whal. Commn* 32: 655-666.
- Clapham, P.J. and Mayo, C.A. 1987. Reproduction and recruitment of individually identified humpback whales, *Megaptera novaeangliae*, observed in Massachusetts Bay, 1975-1985. *Can. J. Zool.* 65: 2853-2863.
- Darling, J. 1977. The Vancouver Island grey whales. *Waters (J. Vancouver Aquarium)* 2(1):4-19.
- Darling, J.D. and Jurasz, C.M. 1983. Migratory destinations of North Pacific humpback whales (*Megaptera novaeangliae*). pp.359-68. In: Payne, R. (ed.) *Communication and Behavior of Whales*. Westview Press. Boulder, Colorado.
- Darling, J.D. and Morowitz, H. 1986. Census of 'Hawaiian' humpback whales (*Megaptera novaeangliae*) by individual identification. *Can. J. Zool.* 64: 105-11.
- Dorsey, E.M. 1983. Exclusive adjoining ranges in individually identified minke whales (*Balaenoptera acutorostrata*) in Washington State. *Can. J. Zool.* 61: 174-81.
- Glockner-Ferrari, D.A. and Ferrari, M.J. 1984. Reproduction in humpback whales, *Megaptera novaeangliae*, in Hawaiian waters. *Rep. int. Whal. Commn* (special issue 6): 237-42.
- Herman, L.H. and Antinaja, K.C. 1977. Humpback whales in the Hawaiian breeding waters: population and pod characteristics. *Sci. Rep. Whales Res. Inst., Tokyo* 29: 59-85.
- Katona, S.K. 1986. Biogeography of the humpback whale, *Megaptera novaeangliae*, in the North Atlantic. pp.166-71. In: A.C. Pierott-Balts, S. Vander Spoel, B.J. Zahuanec and R.K. Johnson (eds.) *Pelagic Biogeography*. UNESCO Technical Paper in Marine Science.
- Katona, S.K. and Kraus, S. 1979. Photographic identification of individual humpback whales (*Megaptera novaeangliae*): evaluation and analysis of the technique. Final report to U.S. Marine Mammal Commission.
- Katona, S.K., Harcourt, P.M., Perkins, J.K. and Kraus, S. 1980. *Humpback whales in the western North Atlantic: a catalogue of identified individuals*. 2nd ed. College of the Atlantic. Bar Harbor, Maine.
- Katona, S.K. and Whitehead, H.P. 1981. Identifying humpback whales using their natural markings. *Polar Rec.* 20(128): 439-44.
- Mayo, C.A. 1982. Observations of cetaceans: Cape Cod Bay and Stellwagen Bank, Massachusetts 1975-1979. *Mar. Mamm. Comm.*, Nat. Mar. Tech. Info. Serv.
- Mayo, C.A., Carlson, C., Clapham, P. and Mattila, D. 1985. *Humpback whales of the southern Gulf of Maine*. Center for Coastal Studies, Provincetown, MA.
- Payne, R., Brazier, O., Dorsey, E.M., Perkins, J.S., Rowntree, V. and Titus, A. 1983. External features in southern right whales (*Eubalaena australis*) and their use in identifying individuals. pp. 371-445. In: Payne, R. (ed.) *Communication and Behavior of Whales*. Westview Press. Boulder, Colorado.
- Schevill, W.E. and Backus, R.H. 1960. Daily patrol of a *Megaptera*. *J. Mammal.* 41(2): 279-81.
- Sears, R. 1984. Photo-identification of individual blue whales. *Whalewatcher (J. Amer. Cetacean Soc.)* 18(3): 10-12.
- Whitehead, H. 1982. Population of humpback whales in the Northwest Atlantic. *Rep. int. Whal. Commn* 32: 345-53.
- Whitehead, H. 1983. Structure and stability of humpback whale groups off Newfoundland. *Can. J. Zool.* 61(6): 1391-7.
- Whitehead, H., Harcourt, P., Ingham, K. and Clark, H. 1980. The migration of humpback whales past Bay de Verde Peninsula, Newfoundland during June and July, 1978. *Can. J. Zool.* 58(5): 687-92.
- Whitehead, H., Chu, K., Perkins, J.K., Bryant, P. and Nichols, G. 1983. Population size, stock identity and distribution of the humpback whales off west Greenland - Summer 1981. *Rep. int. Whal. Commn* 33: 497-501.
- Whitehead, H. and Gordon, J. 1986. Methods of obtaining data for assessing and modelling populations of sperm whales which do not depend on catches. *Rep. int. Whal. Commn* (special issue 8): 149-66.

Some Observations on Wound Healing and Persistence of Scars in *Tursiops truncatus*

C.H. Lockyer

Sea Mammal Research Unit, c/o British Antarctic Survey, High Cross, Madingley Road, Cambridge CB3 0ET, UK

R.J. Morris

Dept of Anatomy, University of Queensland, St Lucia, Brisbane, N.E. Australia 4067

ABSTRACT

Observations of wound healing from bottlenose dolphins off the coast of Britain and Australia are presented. The type of wounds monitored fall into the following categories. (1) **Superficial scratches** not penetrating the dermal skin layer which tend to heal within a few weeks and may become indiscernible within months. (2) **Superficial to deeper scratches and minor wounds** often penetrating beyond the skin to the blubber layer which can heal within a few weeks and the resultant scars diminish over time with the ingress of adjacent pigmented tissue, usually becoming indiscernible within about 5–20 months although a very few may persist indefinitely. (3) **Deeper wounds** penetrating beyond the blubber and frequently causing profuse bleeding which take five or more weeks to heal and, despite gradual shrinkage of the scars over a period of months even years, persist permanently in the form of unpigmented patches and/or indentations on the body. (4) **Major wounds** penetrating the skin, blubber and muscle, often with significant loss of tissue which can heal completely within 6–7 months but which leave scars with areas of apigmentation and body deformation. Bullets which penetrate the body but are not fatal also cause permanent indentations on the body, although there is not necessarily much apigmentation in the surrounding skin area. In general, all body areas are vulnerable to scarring although some areas are more susceptible to different types of wounding. Excluding the major injuries, scars on certain areas of the body such as the head, back, dorsal fin and tail flukes appear most likely to be useful in the reidentification of individuals.

INTRODUCTION AND METHODS

During a study to identify individual bottlenose dolphins which had come to frequent local waters around the British Isles, and thus follow their movements, we found that dolphins continue to acquire marks and scars regularly throughout their lives, some of which are temporary and others more permanent. The question was then raised as to what constituted an identification mark which could be used reliably over long periods of time; especially in the case of animals which disappeared but subsequently reappeared elsewhere some time later. The study was therefore expanded to include the monitoring of the source of acquisition of wounds, their subsequent healing and final scar permanence.

The basis of this study comprises a number of opportunistic observations on body wounds, marks and scars on several identifiable free-living bottlenose dolphins, *Tursiops truncatus*, during the period 1972–86. The observations were made by both authors in British Atlantic coastal waters as well as by Morris (see Corkeron, Morris and Bryden, 1987a;b) in the warmer waters of Moreton Bay, Queensland, Australia. The method has been to keep a photographic library of each subject dolphin, where feasible, by regularly monitoring overall body appearance of the animal both above and under water. No absolute photographic criteria have been set, except to photograph the animal, usually with 35mm colour film, using a data-back camera when available. Photographs were taken from as close a range as possible, usually 0.5–5m, and the scars were closely examined both visually and tactually whenever possible. This was possible with some of the animals off the British coast which have become quite familiar with swimmers and will allow handling. The use of sound video film, both at the surface and underwater, was also helpful on occasions.

The main objective was to follow the history of fresh wounds and their apparent causes through the stages of healing to the final scars, and then monitor the relative permanence of such scars as a guide to use in identification of individuals. Studies of this nature have been carried out experimentally with captive dolphins in treated water (Bruce-Allen and Geraci, 1985), but monitoring of animals in the natural environment is likely to indicate more realistic time scales of healing and scar permanence for the specific purpose of identification of individuals.

The idea of using natural marks and scars is not new (see the review of Würsig and Jefferson, 1990) and has been used on bottlenose dolphins with notable success (e.g. Wells and Scott, 1990). Scott, Wells and Irvine (1990) have followed changes in dorsal fin notches of Florida bottlenose dolphins over four years to monitor the permanence of these as markers for identification.

RESULTS

Experience and examination of the photographic histories of body marks and scars indicated that these scars could be broadly classified into one of four categories: superficial scratches; deeper scratches and minor wounds; deeper wounds; and major wounds.

(1) Superficial scratches

These are found on the skin and result in no obvious permanent scars. They include small nicks in the skin, caused by abrasions from contact with rocks and other objects which do not penetrate the dermis, and heal and disappear within weeks. No specific examples are presented here.

(2) Deeper scratches and minor wounds

These penetrate the skin and often the blubber tissues, and eventually disappear after 5 or more months. Several examples, which include tooth rakes from conspecifics and other species, otter claw rakes, and other damage such as small puncture wounds, acquired from more harsh physical contact with the environment, are presented here as illustrations of this type of healing process.

(a) Tooth rakes on the body

Fig. 1 demonstrates the virtual disappearance of white rake scars on the left dorsal side of the body, at the level of the pectoral flipper, in a 2.5–2.7 m juvenile male bottlenose dolphin, Simo, in British coastal waters (Lockyer and Morris, 1987; Morris and Lockyer, 1988). The rakes, clearly visible in March 1985 (Fig. 1a), were virtually indistinguishable by June 1985 (Fig. 1b). Other deeper marks in this body area were, however, still visible. Fig. 2 shows rake marks in a similar body region for an elderly 4.1 m male, Percy, in British coastal waters (Lockyer and Morris, 1985a;b; 1986). The photographs record the white rake scars present in July 1984 (Fig. 2a) becoming quite faint by November 1984 (Fig. 2b). Tooth rakes are discussed further below.

(b) Otter claw rakes

Fig. 2 shows a fresh claw scrape, believed to have been inflicted by an otter (*Lutra lutra*). It was clearly visible in July 1984 (Fig. 2a) and had become quite white by November 1984 (Fig. 2b) (Lockyer and Morris, 1985a; 1986). Unfortunately, the dolphin (Percy) disappeared at about this time, so that further monitoring of this scar was not possible.

(c) Dorsal fin scrapes

Fig. 3 documents the gradual disappearance of a bright white mark originating from a wound in summer 1984 on the right side of the dorsal fin of a juvenile male, Simo. The photographs were taken in March 1985, July 1985 and October 1985 (Figs 3a-c, respectively). The white mark which had been used as an identification mark, had virtually disappeared within about 20 months of its first

appearance (Morris and Lockyer, 1988). During the period, the fresh grey-looking tooth rakes on the right flank (Fig. 3a) in March 1985 appeared white by October 1985 (Fig. 3c). A newly acquired diagonal mark (Fig. 3b) on the dorsal fin in July had also whitened by October 1985 (Fig. 3c). This animal subsequently disappeared, but these types of scars generally disappear within 5–12 months.

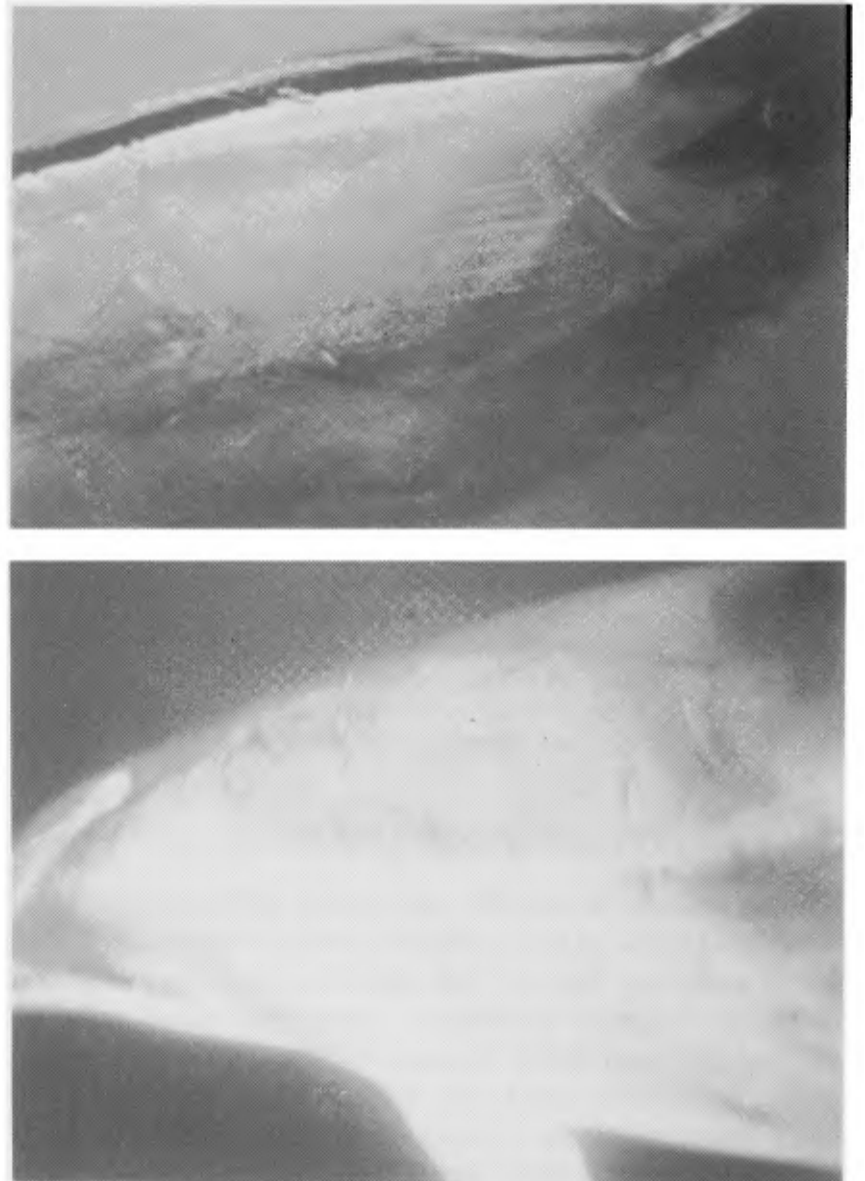

Fig. 1. Tooth rakes on Simo, a juvenile male bottlenose dolphin in British coastal waters: (a) March 1985 (b) June 1985.

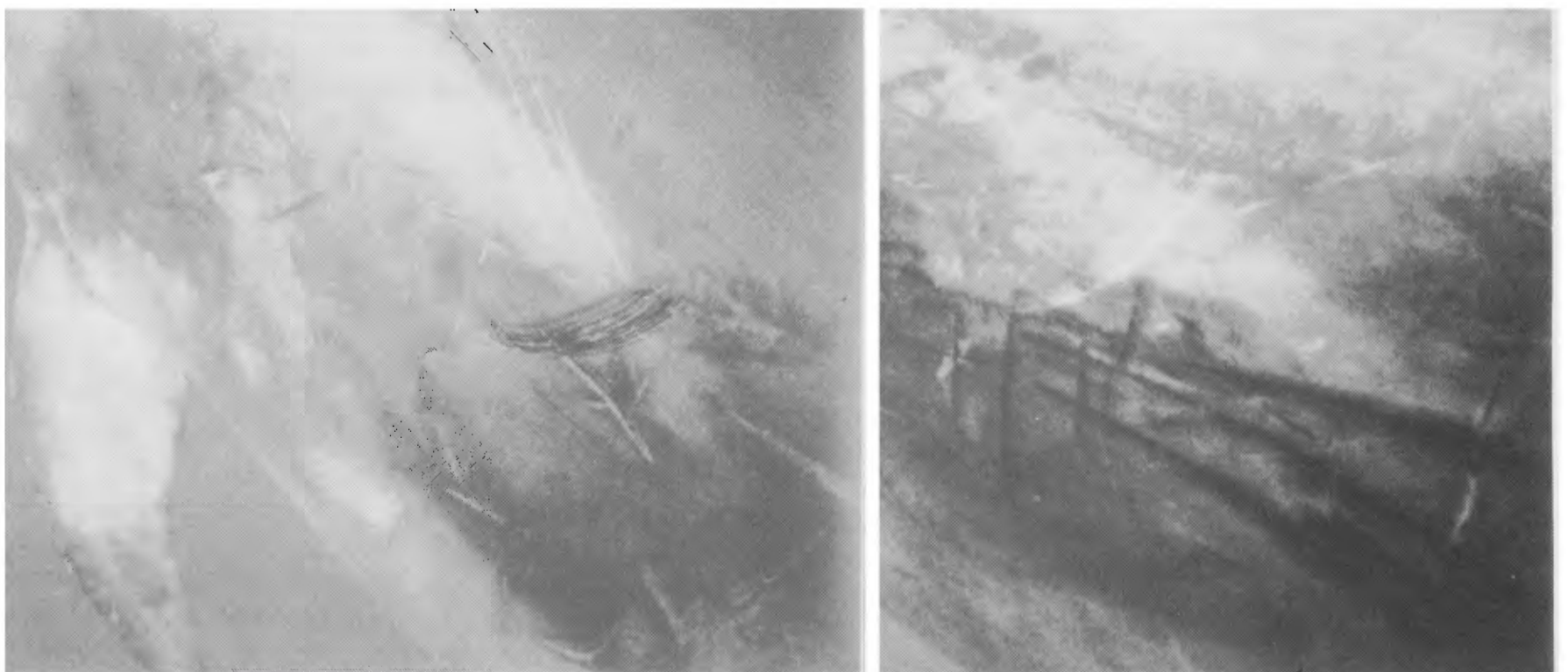

Fig. 2. Tooth rakes (upper right) and otter claw scrape (immediately below tooth rakes) on the dorsal flank of Percy, an elderly male bottlenose dolphin in British coastal waters: (a) July 1984 (b) November 1984.

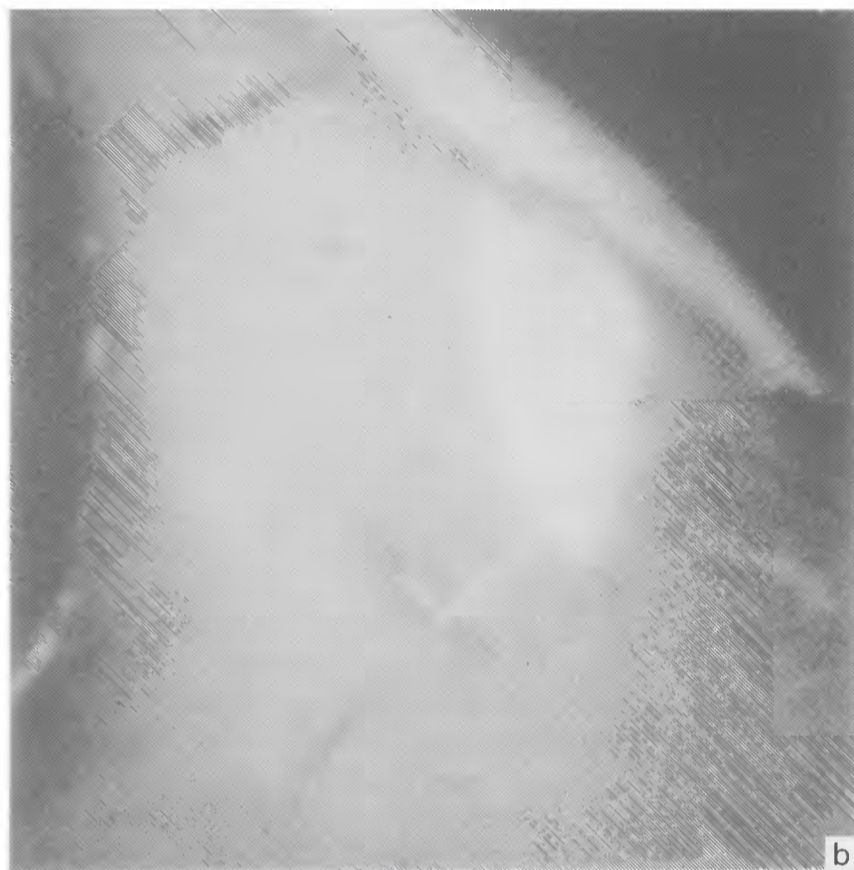
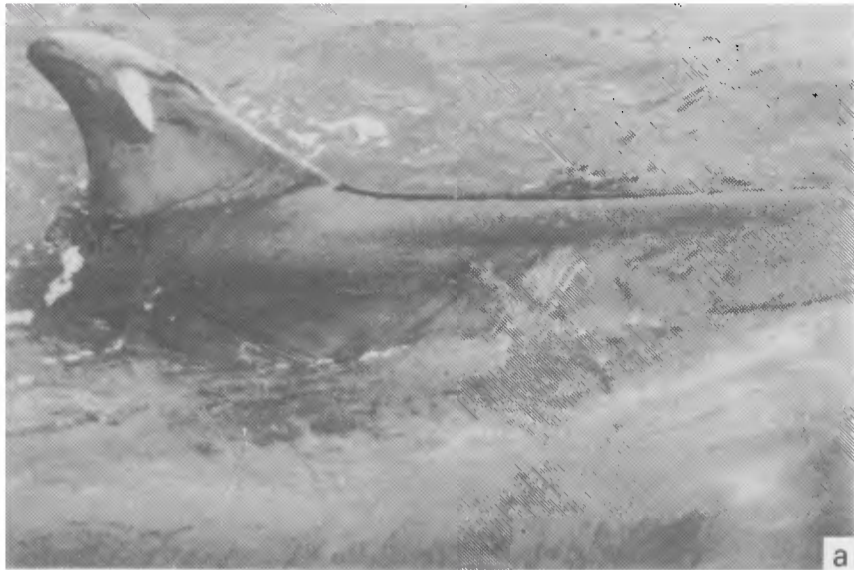

Fig. 3. Dorsal fin scars and tooth rakes on the right flank of Simo, a juvenile male bottlenose dolphin in British coastal waters: (a) March 1985 (b) July 1985 (c) October 1985.

(d) Tail fluke scrapes

Fig. 4 illustrates two scars photographed in April 1985 (Fig. 4a) and July 1985 (Fig. 4b) for Simo. One is a long white scratch at right angles to the fluke edge; the other, a small 'v'-shaped white mark on the opposite side. Although these scars were visible during this period, by October 1985, both were virtually undetectable and thus no longer useful for identification. However, another more

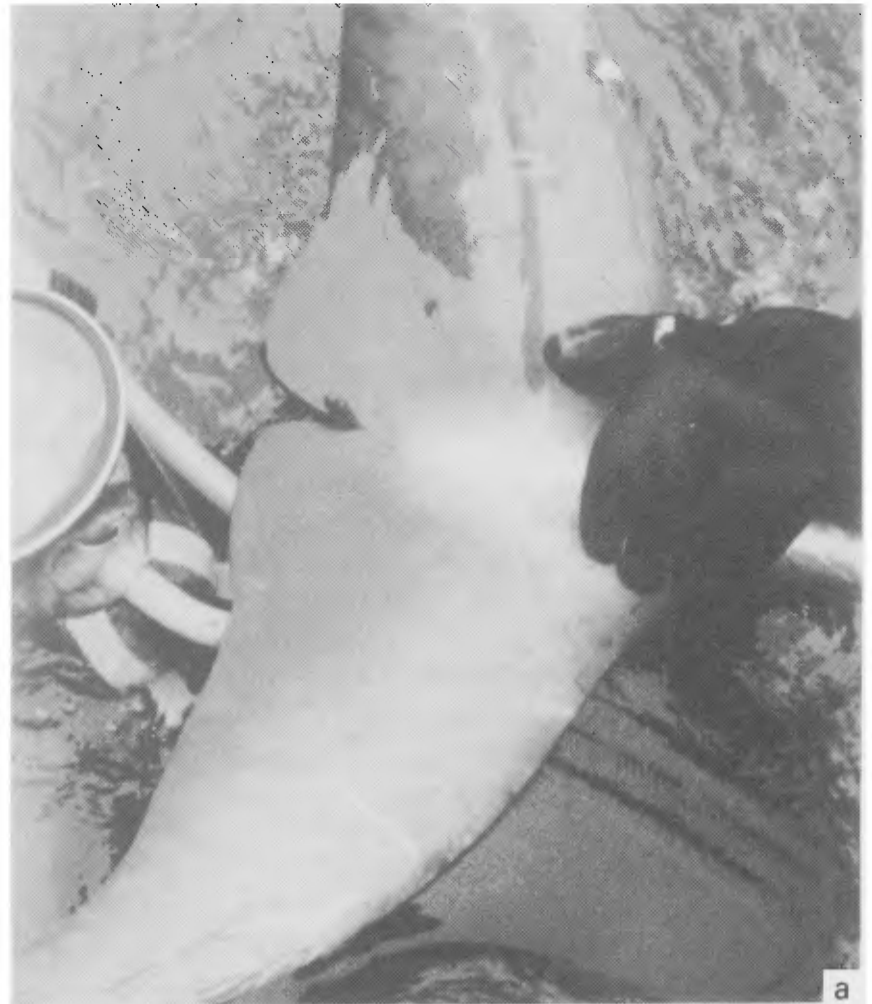

Fig. 4. Tail fluke scars on Simo, a juvenile male bottlenose dolphin in British coastal waters: (a) April 1985 (b) July 1985.

permanent scar, evident as a small nick or puncture in the leading edge of the fluke (Figs 4a,b) on the same side as the 'v'-shaped scar, was still evident in October 1985. However, the extent of the white area had diminished, and we suspect that it also would have shrunk to insignificant size within one to two years, bearing in mind the discussion below.

(e) Other scars of semi-permanent nature

Many examples of these are reported by Lockyer and Morris (1985a; 1986) for Percy. The causes include accidental hooking by fish-lines and net-entanglement, as well as scars about the mouth, caused perhaps by squid prey (Lockyer and Morris, 1985a).

(3) Deeper wounds

These penetrate the skin, blubber and muscle, and frequently cause profuse bleeding at the time they are received. They may be caused by external impact or by a long-term source of eroding infection resulting in ulceration.

(a) Collision injury

Fig. 5 demonstrates the history of a scar caused by a severe blow to the top of the head of a dolphin called Beaky, a 3.6m male, in British waters between 1972 and 1978 (Lockyer, 1978; Lockyer, Flewelling, Madgwick and Morris, 1978; Lockyer, 1990). The injury was caused by a collision with the skeg of a boat in July 1974. Fig. 5a shows the condition of the wound after about 5–6 weeks, during which time initial healing had taken place. However, severe bruising and swelling of the area were still apparent. By September 1977 (Fig. 5b) the only remaining evidence of this injury was a small bright white mark close to the blowhole. This mark was used reliably and extensively for reidentification of this animal which travelled south along the coast of the British Isles, disappearing from one location and then reappearing at another. Over four years, the southward movement of the dolphin along almost half the length of the British Isles was accurately recorded using this identifying scar (Lockyer, 1978; 1990). Other types of collision injuries which we have frequently observed, but do not demonstrate here, are those received from boat propellers, which result in deep gashes across the body, often the tail head and back. This type of injury is thought to be more specifically relevant to the more sociable dolphins which will readily approach boats and water craft and play around the underneath of the hull. Lockyer (1978) reported this as a common problem with Beaky who would play 'Russian roulette' around the moving propeller. This is rather unusual behaviour.

(b) Scars from infection

A specific example is not shown here, but Lockyer (1987) described such a scar for Beaky as a permanent identification mark. That scar was disc-shaped and



Fig. 5. Head injuries near the blowhole and bullet wound scar on the right side of the head of Beaky, an adult male bottlenose dolphin in British coastal waters: (a) summer 1974 (photograph by courtesy of Horace Dobbs) (b) September 1977.

apparent on the tip of the jaw (it just visible in Fig. 5a). It was originally caused by ulceration during 1972. This type of pocked, pitted scarring on *Tursiops* mandibles is quite common in old animals (Harrison and Ridgway, 1971).

(4) Major wounds

Such wounds penetrate the skin, blubber and underlying muscle, with frequent significant loss of body tissues and even appendages such as dorsal fins, flukes and flippers.

(a) Gunshot wounds

Fig. 5 shows the permanence of a bullet wound received by Beaky in August 1972, close to the right eye. The first photograph (Fig. 5a) was taken in summer 1974. The second, taken in autumn 1977 (Fig. 5b), shows the permanent, healed, pit-like depression. No photographs are available for the period when the wound was first received because the dolphin immediately shied away from any human contact, even at a distance (Lockyer, 1978).

(b) Predatory shark bites

Corkeron *et al.* (1987a;b) have detailed examples of major injuries for bottlenose dolphins off the coast of Queensland, Australia, with specific reference to shark attacks on identifiable individuals. Here we summarise the findings in the light of scar permanence. Corkeron *et al.* (1987a) reported that predatory shark bites which afflict over 36% of dolphins in Moreton Bay (Corkeron *et al.*, 1987b) heal substantially within a month and can heal completely within 6–7 months. The scars, however, are permanent with areas of apigmentation and body deformation. Fig. 6 demonstrates recovery from near-amputation of the caudal peduncle, an injury most likely caused by Great White (*Carcharodon carcharias*) or Tiger (*Galaeocerdo cuvieri*) sharks. Fig. 7 demonstrates an initial fresh injury from shark attack, thought to be caused by the Great White (Corkeron *et al.*, 1987b). Fig. 8 shows the completely healed bite areas on a different dolphin, with the apigmentation characteristic of this type of wound (Corkeron *et al.*, 1987a).

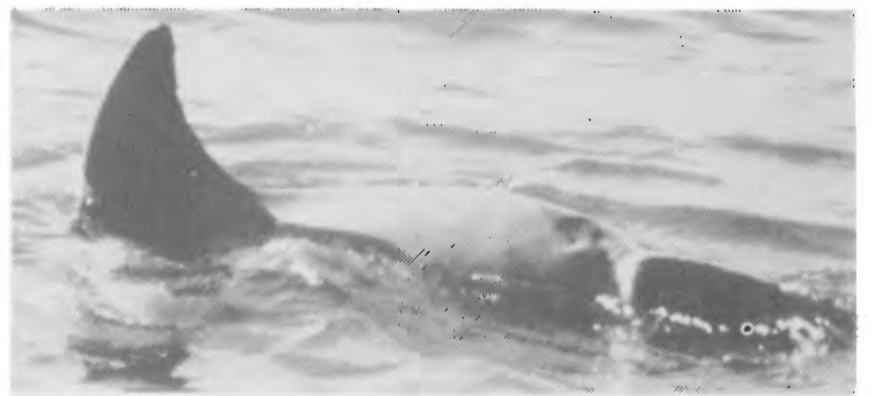

Fig. 6. Body mutilation from shark attack in bottlenose dolphin, Moreton Bay, Queensland, Australia. (Photograph by courtesy of Peter J. Corkeron.)

(c) Dorsal fin mutilations

Figs 7 and 9 demonstrate the permanent results of damage in the form of tissue loss to the dorsal fin of Moreton Bay dolphins. Such injuries, when severe, as in Fig. 7, may be caused by shark attack (Corkeron *et al.*, 1987b), but could also be caused by fighting with conspecifics and other toothed cetaceans, and in cases similar to that in Fig. 9, perhaps by harsh physical contact with the environment (e.g. boat propellers).



Fig. 7. Shark bite injury on the body and dorsal fin mutilation of bottlenose dolphin, Moreton Bay, Queensland, Australia. (Photograph by courtesy of Peter J. Corkeron.)

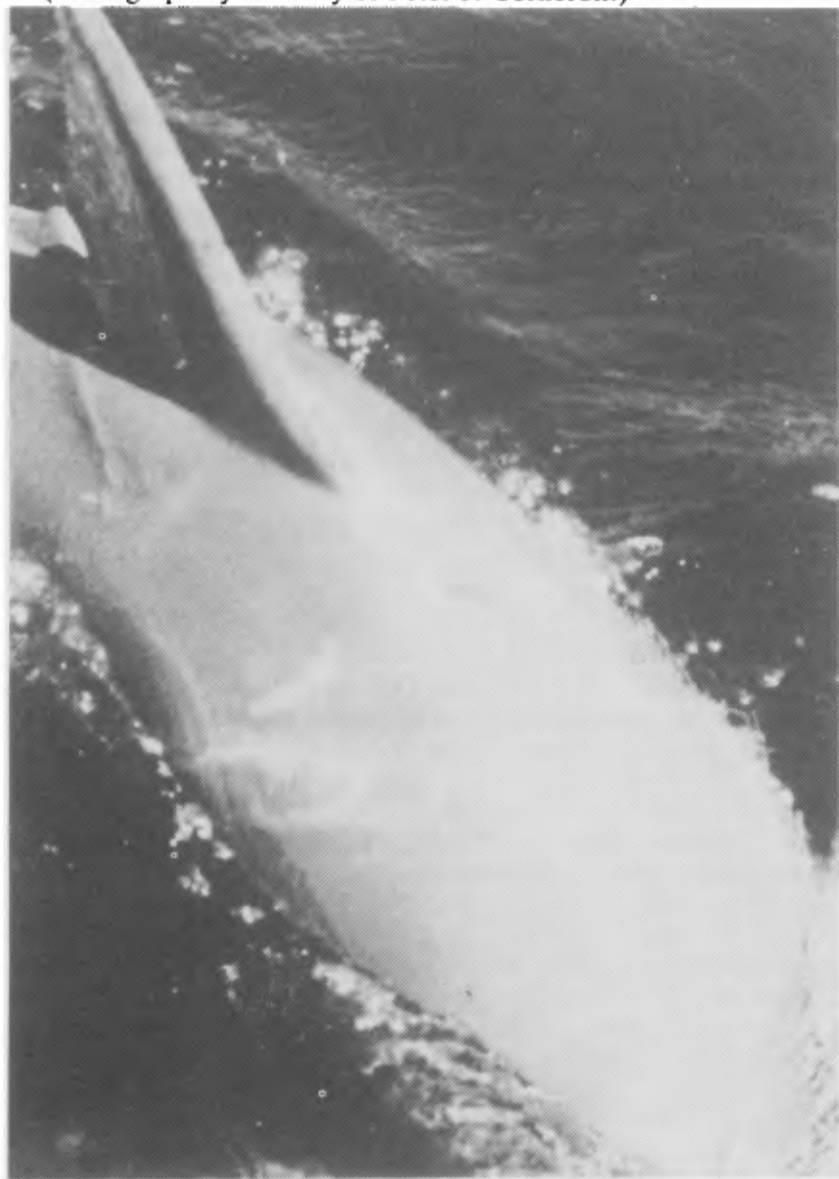

Fig. 8. Healed shark bite scars on the body of bottlenose dolphin, Moreton Bay, Queensland, Australia. (Photograph by courtesy of Peter J. Corkeron.)

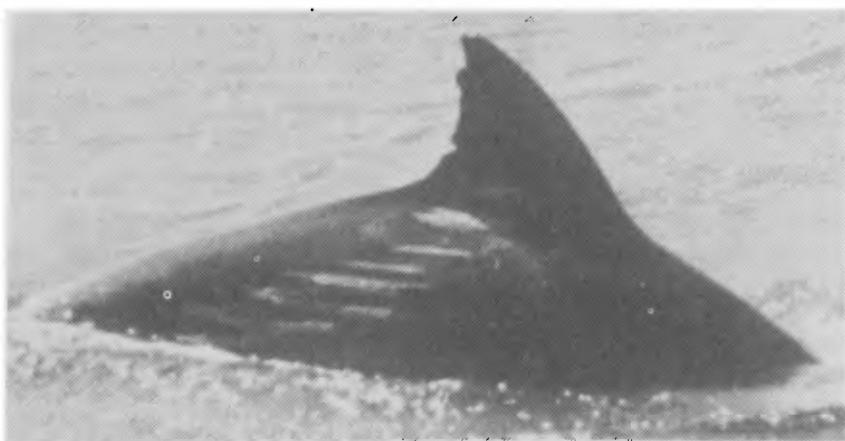

Fig. 9. Dorsal fin mutilation of bottlenose dolphin, Moreton Bay, Queensland, Australia.

DISCUSSION AND CONCLUSIONS

The results presented above are intended as a guide to some of the variety of sources of wounding, healing times and conditions of permanence of scars in bottlenose dolphins living in the wild. The bottlenose dolphin is most frequently found in inshore coastal waters, where contact with a wide variety of sources of injury can be anticipated, ranging from inanimate topographical features such as rocks and boats, to interaction with other animals in the form of conspecifics, prey and predators.

It is clear that the dolphins will constantly incur small scrapes and nicks to the skin, including tooth rakes, mainly of a superficial nature. These are not generally permanent according to our observations, and can be expected to have limited use for reidentifying individuals over periods of more than a few weeks or months. Although initial healing of wounds is rapid (only five weeks for even deep wounds), scars from some superficial wounds may remain identifiable for between 5–20 months. Würsig and Würsig (1977) observed that scratches and bites were only useful for 6–12 months for identification. Such injuries occur all over the body, but are clearly most useful for identification if appearing on the dorsal fin, head, back and even the flukes; the only body regions likely to be seen with any regularity when an animal surfaces. If such temporary markers are used for identifying individuals, continual monitoring is essential. As old scars disappear, new ones replace them almost constantly, thereby superficially altering the gross appearance of an animal which may only be visible to the observer in a favourable aspect for a limited period.

The more extensive injuries which result in mutilation and/or permanent pigmentation changes, particularly in the body regions of the back, dorsal fin, head and tail flukes, are clearly the most precise means for identifying individuals. However, except in locations such as Moreton Bay, where such incidences are commonplace, they may prove to be less helpful because of low occurrence. Even though such marks appear to be permanent, continual monitoring of individuals is still important. Recurrent shark attack is possible, resulting in new injuries, as well as acquisition of other new scars.

Skin healing mechanisms and rates at the cellular level with the study of melanocyte migration and regeneration in bottlenose dolphins have been reported by Bruce-Allen and Geraci (1985). They believed that the apparently rapid rate of healing in the dolphin integument was perhaps related to the absence of a 'scab'; this being replaced by a buffer layer of degenerating cells which protected the underlying regrowth of tissue. Dolphin dermis also contains numerous dermal papillae resulting in extensive folding of the germinal layer, causing rapid repair of the epithelium. Bruce-Allen and Geraci (1985) reported that in areas where melanocytes were not actually damaged, repigmentation eventually occurred. Thus, tooth rakes, which disappear with time, are unlikely to cause melanocyte damage. Harrison and Thurley (1974) described the melanocytes as residing deep in the epidermis giving rise to columns of pigmented cells. This may explain why deep wounds which penetrate the dermis and disrupt the melanocyte layer usually give rise to discrete areas of apigmentation. Brown, Geraci, Hicks, St Aubin and Schroeder (1983) demonstrated that the basal germinative epithelial cells of dolphins proliferated at many times faster than those of terrestrial mammals

causing dolphin skin to be relatively thick. This in itself is likely to give some measure of protection from injury, unless severe.

It is apparent that all body areas are vulnerable to injury and subsequent scarring although the susceptibility to different types varies over the body. Any body region frequently exposed at the surface during respiration is probably more likely to be helpful for identifying individuals, especially the top of the head, back and dorsal fin. The types of marks occurring in these areas are white tooth rakes, white scrape marks from contact with objects, mutilations (indentations and nicks) of the dorsal fin – most usually of the trailing edge of the fin, and variable whitish scars caused by different factors both minor and major. Of these, many of the whitish unpigmented skin areas appear not to be permanent, being mostly caused by superficial injuries. Changes to dorsal fin shape appear to be potentially most useful for long-term identification. Those types of scars which affect dorsal fin outline, have been used as a means of permanent identification of individual bottlenose dolphins by Caldwell (1955), Irvine and Wells (1972), Scott *et al.* (1990) and Würsig and Würsig (1977), amongst others, with great success. Indeed, Asper and Odell (1980) attempted to surgically cut notches into fins of bottlenose dolphins but encountered problems with bleeding. However, Bigg (1982) found that the use of such experimental techniques on killer whales, *Orcinus orca*, were successful, with the scars enduring for more than seven years and acting as permanent identifiers.

In general, the recording of as many different, natural identifying features for each individual on a regular basis is the best non-invasive method for recognition of individual bottlenose dolphins.

ACKNOWLEDGEMENTS

The authors gratefully acknowledge research grants from the Royal Society of London, the Nuffield Foundation, research facilities supplied to R.J. Morris by the University of Queensland in collaboration with Michael M. Bryden and Peter J. Corkeron, and research funding through the Marine Sciences and Technologies Grants Scheme of Australia to Michael M. Bryden. The help and field support from Margaret Klinowska in the British studies between 1985 and 1987 is gratefully acknowledged. The authors thank Aleta Hohn, Michael D. Scott and G.P. Donovan for helpful reviews of this paper.

REFERENCES

- Asper, E.D. and Odell, D.K. 1980. Bottlenose dolphin local herd monitoring: capture, marking, collection of biological data, and follow-up observations of marked animals. Hubbs-Sea World Res. Inst. Tech. Rep. No. 80-122:1-119.
- Bigg, M. 1982. An assessment of killer whale (*Orcinus orca*) stocks off Vancouver Island, British Columbia. *Rep. int. Whal. Commn* 32:655-66.
- Brown, W.R., Geraci, J.R., Hicks, B.D., St Aubin, D.J. and Schroeder, J.P. 1983. Epidermal proliferation in the bottlenose dolphin (*Tursiops truncatus*). *Can. J. Zool.* 61(7):1587-90.
- Bruce-Allen, L.J. and Geraci, J.R. 1985. Wound healing in the bottlenose dolphin (*Tursiops truncatus*). *Can. J. Fish. Aquat. Sci.* 42:216-28.
- Caldwell, D.K. 1955. Evidence of home range in the bottlenosed dolphin. *J. Mammal.* 36(2):304-5.
- Corkeron, P.J., Morris, R.J. and Bryden, M.M. 1987a. A note on the healing of large wounds in bottlenose dolphins, *Tursiops truncatus*. *Aquat. Mamm.* 13(3):96-8.
- Corkeron, P.J., Morris, R.J. and Bryden, M.M. 1987b. Interactions between bottlenose dolphins and sharks in Moreton Bay, Queensland. *Aquat. Mamm.* 13(3):109-13.
- Harrison, R.J. and Ridgway, S.H. 1971. Gonadal activity in some bottlenose dolphins (*Tursiops truncatus*). *J. Zool.* 165:355-66.
- Harrison, R.J. and Thurley, K.W. 1974. Structure of the epidermis in *Tursiops*, *Orcinus* and *Phocoena*. pp.45-71. In: R.J. Harrison (ed.) *Functional Anatomy of Marine Mammals*. Vol.2. Academic Press, New York. 366pp.
- Irvine, A.B. and Wells, R.S. 1972. Results of attempts to tag Atlantic bottlenosed dolphins (*Tursiops truncatus*). *Cetology* 13:1-5.
- Lockyer, C. 1978. The history and behaviour of a solitary wild, but sociable, bottlenose dolphin (*Tursiops truncatus*) on the west coast of England and Wales. *J. Nat. Hist.* 12:513-28.
- Lockyer, C. 1990. Review of incidents involving wild, sociable dolphins, worldwide. pp. 337-53. In: S. Leatherwood and R.R. Reeves (eds.) *The Bottlenose Dolphin*. Academic Press, San Diego. 643pp.
- Lockyer, C., Flewelling, C., Madgwick, A. and Morris, R.J. 1978. Some field observations and experiments on a bottlenosed dolphin. *Progr. Underw. Sci.* 3:177-90.
- Lockyer, C. and Morris, R.J. 1985a. Body scars of a resident, wild bottlenosed dolphin (*Tursiops truncatus*): information on certain aspects of his behaviour. *Aquat. Mamm.* 11(2):42-5.
- Lockyer, C. and Morris, R.J. 1985b. A wild but sociable dolphin off Portreath, north Cornwall. *J. Zool.* 207:605-30.
- Lockyer, C. and Morris, R.J. 1986. The history and behaviour of a wild, sociable bottlenose dolphin (*Tursiops truncatus*) off the north coast of Cornwall. *Aquat. Mamm.* 12(1):3-16.
- Lockyer, C. and Morris, R.J. 1987. Observed growth rate in a wild juvenile *Tursiops truncatus*. *Aquat. Mamm.* 13(1):27-30.
- Morris, R.J. and Lockyer, C. 1988. 22-months in the life of a juvenile bottlenose dolphin. *Aquat. Mamm.* 14(2):49-62.
- Scott, M.D., Wells, R.S. and Irvine, A.B. 1990. Tagging and marking studies on small cetaceans. pp.235-44. In: S. Leatherwood and R.R. Reeves (eds.) *The Bottlenose Dolphin*. Academic Press, San Diego. 643pp.
- Wells, R.S. and Scott, M.D. 1990. Estimating bottlenose dolphin population parameters from individual identification and capture-release techniques. Paper SC/A88/P23 (published in this volume).
- Würsig, B. and Jefferson, T.A. 1990. Methodology of photo-identification for small cetaceans. Paper SC/A88/ID13 (published in this volume).
- Würsig, B. and Würsig, M. 1977. The photographic determination of group size, composition and stability of coastal porpoises (*Tursiops truncatus*). *Science* 198:755-6.

Comparison of Abundance Estimation Techniques for the Western North Atlantic Right Whale (*Eubalaena glacialis*)

Carol Price Fairfield

Graduate School of Oceanography, University of Rhode Island, Narragansett, Rhode Island 02882, USA
Current Address: Minerals Management Service, MS 644, 381 Elden Street, Herndon, VA 22070, USA

ABSTRACT

Population abundance estimates for the right whale, *Eubalaena glacialis*, in the western North Atlantic were calculated from individual identification data collected from Nova Scotia to Florida during 1979–84. Three mark-recapture population models were used in the calculations: the original and the unbiased Jolly-Seber open population models, as well as the Bailey modified Petersen closed population models. Model assumption violations resulting from characteristics of the natural tag, and from right whale behaviour and distribution are presented, and the resulting effects on the abundance estimates are summarised and quantified when possible. The mark-recapture abundance estimates were 2–14 times more precise than estimates calculated from the same survey data using line-transect survey models. The closed population models generally yielded slightly more precise estimates than the open models. The mark-recapture abundance estimates, although precise, proved to be underestimates, as these were often less than the minimum number of whales actually identified in some years, and may be reflecting only a portion of the population. Modifications needed in currently used survey and analytical techniques are suggested.

INTRODUCTION

The severe depletion of right whales, *Eubalaena glacialis*, in the western North Atlantic (Brownell, Best and Prescott, 1986) has led to efforts in recent years to produce reliable historic and present day abundance estimates for this species to assess population trends and status.

Abundance estimates using line transect methods have been calculated for right whales from Nova Scotia to Cape Hatteras, North Carolina during 1979–81 (Winn, 1982) and in the Great South Channel (GSC) area off Cape Cod, Massachusetts in 1984 (Winn, Scott and Kenney, 1985). Large variances are associated with these estimates, making them of limited use for monitoring changes in the population size of this endangered species. Alternative methods of calculating abundance estimates are necessary.

Individual North Atlantic right whales can be identified from callosity patterns and associated whale lice (cyamids) on the rostrum (Watkins and Schevill, 1979; Price and Winn, 1982; Kraus, Moore, Price, Crone, Watkins, Winn and Prescott, 1986; Price, 1987). This paper applies mark-recapture models to right whale individual identification data collected from 1979–84 by researchers at the University of Rhode Island (Winn, 1982; Winn *et al.*, 1985; Price, 1987). Although additional individual identification data are available from other institutions along the eastern US coast, they are not included in this analysis because corresponding line transect abundance estimates could not be calculated due to the data collection methodologies employed.

Of the mark-recapture models available, the Petersen two-sample closed population model and the Jolly-Seber multiple-sample open population model recommended by Hammond (1986) and previously used in cetacean studies were used. This paper examines whether these models are applicable to the right whale data by comparison with line-transect estimates obtained from the same data and with the total number of whales individually identified.

METHODS

Data sources

Photographs and associated sighting data for right whales observed in an area extending along the eastern North American seaboard from the southern portion of Nova Scotia to Florida, were used to identify individual whales (Price, 1987). Only photographs which were of sufficient quality to illustrate extensive details of the callosity-cyamid pattern were used in this analysis.

Mark-recapture models were applied using data from two sources.

(1) *The Cetacean and Turtle Assessment Program (CeTAP) at the University of Rhode Island (URI)*. Surveys were conducted from November 1978 to January 1982, to evaluate cetacean and sea turtle distribution and abundance between Nova Scotia and Cape Hatteras shoreward of the 2000m isobath (Fig. 1). In addition to the dedicated aerial surveys which provided approximately 7.5% coverage of the study area, data were collected through a Platforms of Opportunity Program, and from species specific surveys carried out during May of 1980 and 1981 in the GSC area east and south of Cape Cod and in the autumn of 1980 and 1981 around the southern portion of Nova Scotia (Fig. 1).

(2) *Cetacean Research Programs at URI*.

These programs obtained data on right whale distribution and abundance from 1982–84 along the eastern US seaboard, with primary emphasis on the GSC area.

Abundance estimation

The CeTAP study area was divided into survey areas which could be sampled in a single day's flight. These were subdivided into three depth strata. Right whale abundance estimates were calculated for each stratum during each

area survey flight conducted from 1979–81 (Winn, 1982). The maximum line transect estimate obtained in a given year from any area was compared with mark-recapture estimates obtained during this study. The maximum estimate calculated for the GSC area in 1984 was also used. No such estimates were available for 1982 and 1983, as systematic surveys were not conducted during these years.

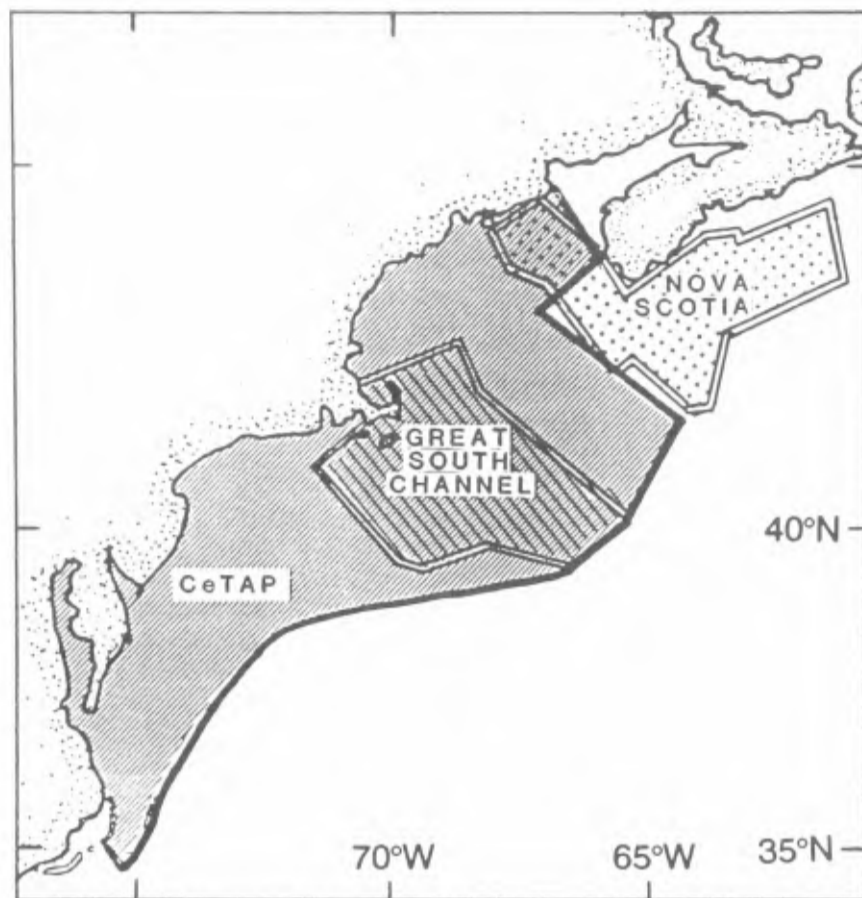

Fig. 1. The area covered by: (1) the general Cetacean and Turtle Assessment Program (CeTAP) surveys - shaded area; (2) the CeTAP and University of Rhode Island Great South Channel right whale surveys - hatched area; and (3) the CeTAP Nova Scotia right whale surveys - stippled area.

The line transect estimates were calculated using a modification of Burnham, Anderson and Laake's (1980) calculations, which corrects for number of whales in each pod and for the time that each whale spends at the surface (Winn, 1982; Winn *et al.*, 1985).

In addition, two 'minimum counts' were obtained during the study period: (1) the minimum number of right whales individually identified each year (Price, 1987); and (2) the maximum number of right whales observed in any single sighting each year (thus avoiding the problem of resightings).

A number of mark-recapture population models have been used in cetacean individual identification studies to obtain abundance estimates. The sampling during the present surveys was designed specifically for line transect sampling; consequently some violations of mark-recapture model assumptions were expected and noted. In this study, two types of models were used: (1) 'open' (which permits birth, death, immigration and emigration) – both the original Jolly-Seber model (Jolly, 1965; Seber, 1965) and the Seber and Manly (1985) modified Jolly-Seber model, which reduces the large bias introduced as a result of small sample sizes; (2) 'closed' (which does not permit birth, death, immigration or emigration) – the Bailey (1951) modified Petersen model, for sampling with replacement, as occurred in this study. Many cetacean workers have used the Chapman (1951) modified Petersen model. However, as Hammond (1986) notes, this is inappropriate for most photo-identification studies, since it assumes sampling without replacement.

Application of mark-recapture models

To reduce errors resulting from geographic variation in sampling effort and in right whale behaviour patterns, mark-recapture abundance estimates were determined for two geographic areas. In the first, data collected throughout the entire study area were included; thus the resultant estimates applied to the whole area from the Bay of Fundy/Nova Scotia region to the southern tip of Florida, extending from the coast and east to approximately the 2,000m isobath.

The second method used data collected exclusively in the GSC area, where the majority of the survey and photographic identification effort was concentrated, especially from 1982–84. The distribution of right whales along the east coast is highly clustered and concentrations of right whales have been observed in the GSC area since 1979 (Winn, 1982; Winn, Price and Sorensen, 1986). The estimates therefore only applied to the animals which entered GSC area.

Abundance estimates were calculated using two different data sets for each of these two defined geographic areas: (1) individual identification data from all dedicated and opportunistic platforms; and (2) only data from dedicated random sample surveys. The latter set was used to try to reduce the potential bias in the abundance estimate due to non-uniform mixing of whales.

The open and closed population models were applied to the two data sets for the two geographic areas, thereby resulting in twelve abundance estimates for each year. For all calculations, each calendar year constituted a sample.

RESULTS

This section presents the results of the calculations. The question of assumption violations and their effect on the estimates, and the wider question of violation of assumptions in mark-recapture studies using photo-identification data, is addressed in the Discussion.

Abundance estimates calculated by applying the mark-recapture models to the various data sets for the entire study area and the GSC area are given in Tables 1 and 2, respectively. Maximum line transect estimates (Winn *et al.*, 1985; unpublished CeTAP data) for each year (or, in one case, for the years 1979–84), calculated from the data set used in the mark-recapture analyses are included in each Table for comparison with the mark-recapture estimates. The maximum number of right whales observed in a single sighting during each year and the number of right whales individually identified each year (Price, 1987) are also included in both Tables. The coefficients of variation ($CV = \text{standard deviation} / \text{sample mean}$), included in parentheses below each estimate in Tables 1 and 2, indicate the relative precision of each estimate.

Examination of Tables 1 and 2 reveals that CVs were generally lower for the closed models, although the lowest CV for each year was similar for both model types: the most precise estimate was obtained in two different years using open models and in three different years using closed models.

For both open and closed models there was no consistent pattern in whether estimates from the full data set or the random flight data set were more precise except that in 1981, the full data set yielded more precise results for both types of model and both areas.

Table 1

Annual right whale population estimates with 95% confidence intervals. Data from the entire study area were used. MSS=maximum number seen in a single sighting. MID=number of identified whales (from Price, 1987). Max LTE=maximum line transect estimate. S&M Open=Seber and Manly open population model. J-S Open = Jolly-Seber open population model. Closed = Bailey's (1951) modified Petersen closed population model.

Year	All data						Random flight data only		
	MSS	MID	Max LTE (CV)	S&M Open (CV)	J-S Open (CV)	Closed (CV)	S&M Open (CV)	J-S Open (CV)	Closed (CV)
1979	4 ¹	10	110±315 ² (1.43)						
1980	46 ¹	44	139±254 ² (0.91)	140±163 (0.58)	222±79 (0.18)	235±264 (0.56)	81±68 (0.42)	134±155 (0.58)	185±208 (0.56)
1981	25	40	165±379 ² (1.15)	145±22 (0.08)	157±78 (0.24)	118±41 (0.17)	134±114 (0.43)	161±158 (0.49)	106±43 (0.20)
1982	8	9			98±102 (0.52)	67±30 (0.22)			
1983	15	4			3±11 (1.83)	36±46 (0.64)			
1984	21 ³	16	257±587 ³ (1.14)			54±86 (0.80)			
'79-'84		92	257±587 ³ (1.14)			116±47 (0.20)			

¹ Winn *et al.* (1981) ² Unpublished CeTAP data ³Winn *et al.* (1985)

Table 2

Annual right whale population estimates with 95% confidence intervals. Data from the GSC area only were used. MSS=maximum number seen in a single sighting. MID=number of identified whales (from Price, 1987). Max LTE=maximum line transect estimate. S&M Open=Seber and Manly open population model. J-S Open = Jolly-Seber open population model. Closed = Bailey's (1951) modified Petersen closed population model.

Year	All data						Random flight data only		
	MSS	MID	Max LTE (CV)	S&M Open (CV)	J-S Open (CV)	Closed (CV)	S&M Open (CV)	J-S Open (CV)	Closed (CV)
1979	4	5	64±192 ² (1.50)						
1980	14	13	45±54 ² (0.60)	135±204 (0.76)	14±129 (4.61)	75±266 (1.77)	153±303 (0.99)	10±58 (2.90)	55±74 (0.67)
1981	25	36	165±379 ² (1.15)	169±169 (0.50)	216±149 (0.34)	104±45 (0.22)	575±1117(0.97)	280±514 (0.92)	120±115 (0.48)
1982	8	7		52±56 (0.54)	93±92 (0.49)	72±32 (0.22)	13±13 (0.50)		
1983	15	4			3±67 (11.16)	28±44 (0.79)			
1984	21 ³	16	257±587 ³ (1.14)			51±74 (0.73)			

² Unpublished CeTAP data ³ From Winn *et al.*, 1985

Table 3

The most precise annual right whale population estimates with 95% confidence intervals and, in parentheses, CVs. GSC estimates from Table 2 and entire study area estimates from Table 1. The number of animals individually identified by all researchers along the east US coast is also given (Kraus, pers. comm.).

Year	GSC		Entire area		Number identified
	Line transect	Mark-recapture	Line transect	Mark-recapture	
1979	64±192 (1.50)		110±315 (1.43)		10
1980	45±54 (0.60)	135±204(0.76)	139±254 (0.91)	222±79 (0.18)	53
1981	165±379 (1.15)	104±45 (0.22)	165±379 (1.15)	145±22 (0.08)	83
1982		72±32 (0.22)		67±30 (0.22)	90
1983		28±44 (0.79)		36±46 (0.64)	69
1984	257±587 (1.14)	51±74 (0.73)	257±587 (1.14)	54±86 (0.80)	102

A comparison of the precision between data from the GSC area and the data from the entire study area revealed that estimates from the latter were almost always more precise. This reduced precision in the GSC area is probably a result of smaller sample sizes.

Table 3 presents, for each year, the line transect estimate and the most precise mark-recapture estimate for both the GSC area and the entire study area. The total number of whales identified by all researchers along the US east coast is also given for the entire study area for 1979–84 (Kraus, pers. comm.). From this Table, the best estimates of the number of right whales for the entire study area are 143–301 in 1980, 123–167 in 1981, 90–104 in 1982, 102–125

in 1983 and 69–82 in 1984. In the GSC area, the only estimates with CVs of less than 0.5 are 83–149 in 1981 and 40–104 in 1982. Note also that none of the line transect estimates had CVs of less than 0.6.

Comparison of the precision of the line transect estimate calculated for the CeTAP area (from Nova Scotia to Cape Hatteras) with the most precise mark-recapture estimate calculated for the entire study area used in this study (Nova Scotia to Florida), indicates that the mark-recapture estimate was five times as precise as the line-transect estimate in 1980 and 14 times as precise in 1981. A similar comparison for the GSC area indicates that although the estimates for both models types were approximately

equally precise for the 1980 data, the mark-recapture estimates were five times more precise in 1981 and approximately twice as precise in 1984.

DISCUSSION

This study has demonstrated that, for the data sets available, right whale abundance estimates obtained from mark-recapture models were more precise than those from line transect models. No line transect estimates exhibited a CV of less than 0.6, while almost all of the mark-recapture abundance estimates calculated for the entire area and almost half of those calculated for the GSC area exhibited CV values lower than this. However, it should be recognised that the aerial surveys were not designed solely to examine right whale abundance or utilized survey techniques which did not account for the clumped distribution observed for right whale; a species specific aerial survey for minke whales around the Icelandic coast gave an estimate with a CV of 0.202 (Donovan and Gunnlaugsson, 1989; Hiby, Ward and Lovell, 1989).

It should also be noted that the precision of estimates obtained using mark-recapture models may also be affected by a correlation between the estimate itself and the estimated variance, causing underestimates to appear more precise than they really are (see e.g. Hammond, 1986). Seber and Manly (1985) caution that 'the construction of suitable confidence intervals [for the unbiased estimators] needs further investigation'.

Although some of the mark-recapture estimates are relatively precise, a comparison of them with the number of whales actually identified as individuals reveals that in 1982 and 1983 the abundance was underestimated. Furthermore, at least 282 individuals have been identified along the east coast between 1979 and 1984 (Kraus, pers. comm.) and it is expected that ongoing collaborative studies will further increase this figure. The 1980 mark-recapture estimate of 143–301 whales for the entire study area is the only mark-recapture figure resulting in an abundance encompassing this cumulative number of documented individuals. The inaccuracy of the mark-recapture estimates suggests that they represent only a portion of the population occurring in the study area. This is probably due to the variability in the intensity of the survey effort in a geographical and temporal sense. For example, the inaccurate 1982 and 1983 estimates are based on individual identification of less than 10 whales in each year, all of which were in the GSC area. Application of these mark-recapture techniques to a more representative data set may reduce the inaccuracy of the resulting estimates.

Kenney, Winn and Brown (1986) used data collected on three surveys in the Great South Channel area to obtain mark-recapture estimates (95% CI) of between 71–221 (CV = 0.26) and 73–333 (CV = 0.32) whales for 23 and 30 May 1985, respectively. Only one resighting was documented during these surveys and used in these calculations, although 37 individuals were identified.

Assumption violations

Until now, no studies applying mark-recapture models to right whale individual identification data have addressed in detail the question of the violation of the models' assumptions and thus the appropriateness of the chosen model.

The effects of the inherent characteristics of this right whale data on the assumptions of the Jolly-Seber open population model and the Petersen closed population model will be examined, particularly with reference to Hammond's (1986) review of the applicability of mark-recapture techniques to the estimation of abundance of naturally marked whales.

The first consideration was whether the data used in this study fit a closed (no birth, death, immigration or emigration) or an open (these processes can occur) population mark-recapture model. The possibility of immigration and emigration occurring in this study area can not be ruled out. Although the study involved extensive coverage of those geographic regions where most recent right whale sightings have been made, additional recent and historic sightings have been recorded, primarily to the north and east of the study area. In addition, the winter breeding ground(s) of this species has (have) not been clearly established, and thus it is unknown whether it (they) were included in the study area. Winn (1982) identified wintering grounds off the Georgia and Florida coasts, which are visited by right whales observed in the northern CeTAP study area (see also Winn, 1983; Kraus, Prescott and Stone, 1984; Mead, 1986). Right whales have also been recorded in the Cape Cod Bay area during the winter months (C. Mayo, pers. comm.), with two possible births reported in this area (Watkins and Schevill, 1982). These studies suggest right whale wintering and breeding grounds that include the Georgia-Florida coasts as well as the Cape Cod Bay area. If the whales observed at some time outside the study area (i.e. north and east of the study area or in presently unknown grounds outside the study area) also spend time within the study area, they likely have the same probability of being marked when they are within the study area as do all other whales. Clearly, if they do not appear within the study area at any time, they will not be considered to be part of the population defined in this study.

Births and deaths do occur in the study area, however, the robustness of the Petersen closed population model permits its use even if the assumption of population closure is violated (Seber, 1982, p.59), but it will lead to overestimation of population size (Seber, 1982, p.73). The estimates will be positively biased by the proportion of recruitment to the average probability of survival at the time of the first sample (assuming marked and unmarked whales have the same average probability of survival), and by the inverse of the average probability of survival at the time of the second sample; the higher the recruitment rate and the lower the probability of survival, the larger this positive bias becomes (Hammond, 1986). Although mortality and recruitment rates can be calculated for use in estimation of recruitment and probability of survival using the Jolly-Seber model (Seber, 1982, p.204), the small sample size here would render the results too imprecise to be useful.

A major assumption of the Jolly-Seber model is that 'every animal in the population, whether marked or unmarked, has the same probability of being caught in the *i*th sample, given that it is alive and in the population when the sample is taken' (Seber, 1982, p.196). As Hammond (1986) points out, inherent differences in the 'catchability' of individuals is probably a feature of all mark-recapture studies, resulting in an underestimate of the population. Several factors inherent in the data used in this study may affect the catchability of right whales, including possible

geographic segregation, seasonal and possibly diurnal clustering of whales and timing of surveys, right whale social behaviour, potential response to human interactions and characteristics of the tag. Each aspect is discussed below.

Calves have not been included in the individual identification data set. For the purposes of this study, calves have been defined as whales which are less than half the length of an accompanying right whale (Goodale, 1982). The callosity-cyamid pattern of calves is often not clearly distinguishable from the smooth black epidermis of the rostrum, making identification unreliable, particularly in aerial photographs (Price, 1987). Although some can be identified, many can not and so all calves were excluded from this study. This should not violate the assumption of equal probability of marking since calves are viewed as not being 'present' in the population during their first year.

Several workers in the Southern Hemisphere have found spatial segregation of female southern right whales on the wintering grounds, with females being present in the inshore calving grounds only in the years in which they calve, usually every three years (Payne, Rowntree, Perkins, Cooke and Lankester, 1990; Best and Underhill, 1990; Bannister, 1990). Payne *et al.* also suggest that three different areas at Peninsula Valdes, Argentina are characterised by different social groups. This would of course result in a possible negative bias in the mark-recapture population estimates (Whitehead, Payne and Payne, 1986). Best and Underhill (1990) and Payne *et al.* (1990) explore ways of avoiding this problem.

Research on North Atlantic right whales has also suggested possible spatial segregation. For example, while only two calves have been documented in the waters off southern Nova Scotia (Kraus, 1985; Winn *et al.*, 1986; Kraus, pers. comm.), the majority of the right whales observed off the coast south of Cape Hatteras, North Carolina, are mother and calf pairs (Winn, 1983). Studies in the Bay of Fundy area suggest that female right whales may exhibit spatial segregation similar to that observed off Argentina (Kraus, 1985).

Winn, Goodale, Hyman, Kenney, Price and Scott (1981) have shown that right whales have a highly clustered distribution in the GSC area. This has also been observed in the areas of the Bay of Fundy, the Scotian shelf (Winn *et al.*, 1986; Kraus, 1985) and off the Georgia and Florida coast (Winn, 1983; Winn *et al.*, 1986). The negative bias in the population estimates introduced by this clustering can be eliminated by using only data collected during the dedicated aerial surveys, which were of a random sample design and alleviate the necessity for uniform mixing of whales throughout the study area. However, the sample sizes for these random surveys are small and yield wide confidence intervals, reducing the precision of the resultant estimates.

A correlation between time of day and proximity of right whales to one another has been suggested (unpublished CeTAP data), with whales forming larger, tighter aggregations during the early morning and early evening hours and dispersing throughout the day, possibly in response to diurnal variability in prey distributions or concentrations. This may introduce a negative bias in the estimates.

As Hammond (1986) points out, a negative bias in the population estimate could be introduced if some whales are consistently less available to be 'marked', although no bias results if whales missing from the sample area are a random

sample of the population. The timing of surveys within a given season could affect this, as whales would not be observed if surveys were conducted before the whales moved into the survey area. The temporal migration of whales may be variable from year to year.

A similar negative bias could also result from a negative or positive alteration in behaviour patterns in response to survey platforms. During the CeTAP aerial surveys, it was noted that right whales which were in small groups (\leq three whales) would often dive as the plane flew over, potentially making them unavailable to be 'marked'. It was difficult to assess whether this behaviour was in direct response to the aircraft, as no sudden, adverse behaviour was observed. In the majority of these instances, identification photographs were finally obtained as a result of several passes over the whale(s). Provided photographs are taken, of course, no bias is introduced. No similar behaviour was observed during the shipboard observations.

While no quantitative studies were carried out by CeTAP to determine the effect, if any, of survey platforms on the behaviour of whales, Payne, Brazier, Dorsey, Perkins, Rowntree and Titus (1983) reported that less than 2% of the southern right whales demonstrated a change in behaviour in response to the survey aircraft. The effect of human activities on right whales may vary considerably between the western North Atlantic and Argentinean waters, with learned avoidance or attraction behaviour possibly being displayed in only one of these areas.

When larger groups of whales ($>$ three) were encountered during aerial and shipboard surveys in the western North Atlantic, the whales were often engaged in very active behaviour usually focused on a central whale (Winn, 1982). This behaviour has not been documented south of Cape Hatteras, to date (H. Winn and S. Kraus, pers. comm.). While no clear alteration of this behaviour was evident as the survey platform approached, several attempts to photograph individuals were often required, as the rostrums of the whales were often obscured by other whales or water disturbances. There has been no indication that these active groups are restricted to a particular age class or sex.

Groups less than and greater than three animals were encountered throughout the study area north of Cape Hatteras, and although the observed behaviour differed between group sizes, the perseverance required to photograph individuals was comparable. Aerial surveys, with more time allocated to circling, ensured that most whales sighted had a high probability of photographic capture, rather than the assumed equal probability of capture. This reduces but does not eliminate the negative bias due to unequal capture probabilities which almost certainly exist (Hammond, 1986). Due to survey design and strategy, this perseverance for photographic documentation was, for the most part, directed at the GSC area.

Variations in the characteristics of individual animals which affect the probability of identification, whether dependent on age, sex or inherent individual variation, will cause an underestimate of the population (Hammond, 1986). This should not be confused with failure to recognise a marked animal, which will result in an overestimation.

A potential problem exists in the North Atlantic right whale where two distinct types of callosity-cyamid patterns are observed: (1) continuous patterns characterised by the

occurrence of callosity tissue from the anterior tip of the rostrum to the anterior margin of the blowholes, and; (2) discontinuous patterns in which the occurrence of the callosity tissue is not continuous along the rostrum. Discrete patches of callosity tissue of varying shapes and sizes occur between areas of smooth epidermis from the anterior tip of the rostrum to the anterior margin of the blowholes. Several studies have shown that continuous callosity-cyamid patterns are more difficult to identify initially than continuous patterns (Price, 1987; Kraus *et al.*, 1986), although Price (1987) has shown that the probability of 'recapturing' both types of callosity-cyamid patterns is approximately equal. This may result in a negatively biased population estimate, as both types of patterns may not have the same probability of being 'marked' in each sample.

Another assumption of the Jolly-Seber model is that 'every marked animal has the same probability of surviving from the i th to the $(i+1)$ th sample and of being in the population at the time of the $(i+1)$ th sample, given that it is alive and in the population immediately after its release' (Seber, 1982, p.196). The youngest whale included in this study was one year or older, and the upper age limit is much greater. The longest time between resightings in this study was seven years (Price, 1987). Hammond (1986) addresses the issue of equal probability of survival in detail. Using the most appropriate regimes of survivorship, he estimated the mean bias in the Jolly-Seber population estimates to be $\pm 3\%$ and concluded that age-dependency in cetacean mortality rates 'is not significantly strong to cause a significant bias in estimated population size as a result of violation on the assumption of equal probability of survival for all animals'.

All mark-recapture models assume that 'marked animals do not lose their marks and all marks are reported on recovery' (Seber, 1982, p.196). The question of permanence of the natural markings on right whales has been addressed by several researchers. Payne *et al.* (1983) have followed doubly-marked southern right whales over at least six years and, although minor changes in the appearance of the callosity-cyamid pattern did occur over time, these variations did not interfere with individual identification on the basis of the natural tag. Similar studies by Price (1987) and Kraus *et al.*, (1986) yielded corresponding results for adult North Atlantic right whales. Therefore, it seems reasonable to assume that a marked adult right whale will always be able to be recognised in a future sample.

It has also been assumed that all marks are reported on recovery. For this study, the quality of the photograph and angle of the animal in the photograph determined inclusion of the photograph for individual identification purposes. Inclusion was not governed by the ease of recognition of the callosity/cyamid pattern. Failure to recognise marked whales in later samples would result in an overestimate of the population size. If fewer matches are made as the number of photographs increased, it may be a function of errors in identification. This would result in population estimates which increased with time, and is a possibility in any natural identification study. The photographic sorting techniques utilised during this study (Price, 1987) were carefully developed to minimise this potential bias. Independent analyses of the individual identification data yielded a 3% error, which is small compared with other errors associated with mark-recapture estimates.

The likelihood that identical whales exist in a population was addressed by Payne *et al.*, (1983). Using a technique described by Pennycuik (1978), they estimated the number of theoretically possible callosity-cyamid patterns, based on the amount of information in the pattern of southern right whales, to be about 10^{14} . This is sufficient to render the probability of 'twins' existing as negligible.

Payne *et al.*'s (1983) assessment of the amount of information available on a callosity-cyamid pattern was limited to discontinuous patterns, which is the only type observed on southern right whales. The continuous callosity-cyamid patterns of the North Atlantic right whale offer fewer identifying features than the discontinuous callosity-cyamid patterns, as fewer descriptive callosity tissue perimeters are available. However, even if there are far fewer possible patterns available, the probability of twins is likewise negligible and would have a negligible effect on the accuracy of abundance estimates for the North Atlantic right whale.

Payne *et al.* (1983) also used a second method of investigating this question. They calculated that if 25 pairs of identical twins existed in the estimated population of 550 right whales off Peninsula Valdes, assuming a random distribution of the whales, the probability of not finding even one set of twins during the individual identification studies was 0.034. The smaller abundance estimates calculated for the North Atlantic right whale would increase this probability to some extent, resulting in an underestimate of abundance as more apparent matches would be recorded than actually exist. However, the precision of the variations in the abundance estimates of the Northern right whale appear to be affected more significantly by factors other than the likelihood of the existence of identical whales.

Overall, the most serious potential bias in mark-recapture estimates of North Atlantic right whale abundance are underestimates resulting from behavioural and distributional characteristics which affect the probability of capture. These affects can be minimised by using only randomly collected data from surveys specifically designed to increase the probability of marking (i.e. the GSC surveys). Subsequent efforts should focus on quantifying these affects of model assumption violations to increase the accuracy of resultant mark-recapture estimates.

Modification of present methodologies

Right whales have been observed to be highly concentrated in relatively well-defined areas. These include: the Great South Channel, Massachusetts Bay and Cape Cod Bay, Bay of Fundy and Southeast Scotian Shelf areas (Winn *et al.*, 1986; Winn, 1982; Kraus *et al.*, 1984). Winn *et al.*, (1986) have shown that while the location of these aggregations in the Great South Channel area is somewhat variable from year to year, such sites remain relatively consistent throughout a given spring.

Modifications to current line transect survey methodologies or the development of appropriate correction factors could address the problem of the clustered geographic distribution of right whales. The CeTAP and URI areas for which aerial line transect abundance estimates were calculated, are considerably larger than the extent of these concentrations.

More precise line transect estimates might be obtained by focusing strictly on the areas of right whale aggregations. A relatively broad area must be surveyed

initially to locate and determine the extent of such aggregations with replicate surveys to account for temporal behavioural variations. Surveys should be started soon after sunrise to take advantage of the apparently tighter morning aggregations, perhaps enhancing the sightability of right whales. The surveys should be designed to accommodate simultaneous photographic documentation of right whales, which would require an observer (and possibly a data recorder) strictly dedicated to photographing individual right whales, and a survey altitude sufficient to obtain high quality photographs. This type of sampling strategy would assist in meeting the assumptions of both the mark-recapture and the line transect models.

It has been suggested that a large percentage of the right whale population along the east coast moves through the GSC area each spring (Winn, 1982; Kraus, 1985; Price, 1987; Winn *et al.*, 1986) although the proportion has not been quantified. Based on the CeTAP and URI studies, the GSC area does not appear to represent a segregated portion of the population. Both males and whales accompanying calves (assumed to be females) have been observed in this area (Winn, 1982), although the proportion of mothers and calves is relatively small. In order to obtain abundance estimates for the entire population with limited resources, it may be pertinent to concentrate survey efforts in the GSC area.

Ongoing comparisons of right whale individual identification photographs collected by researchers throughout the entire study area will enhance our knowledge of the GSC area in several ways, including: (1) allowing the quantification of the percentage of the population which moves through the GSC area and; (2) clarifying the question of segregated use of the habitat by comparison of photographs of all whales throughout the study area which have been sexed or aged.

When monitoring and attempting to manage such a small population, both accuracy and precision are important. Given the extremely small estimated abundances of right whales in the western North Atlantic, the ability to detect small changes in population size is crucial. A fluctuation of a very small number of animals may have a significant impact on the stability of the population as a whole.

This study has demonstrated that neither the mark-recapture models presented here nor previously applied line transect models are adequate for such detailed monitoring. The use of non-intrusive, photographic mark-recapture techniques appears promising although current modelling limitations must be overcome. Violations of model assumptions need to be quantified whenever possible so that resulting estimates are more meaningful. Alternatively, more appropriate mark-recapture and line transect models need to be identified or developed. Having identified the shortcomings of current techniques, it is time to refine our approaches to more effectively address the crucial questions concerning the status of the critically endangered right whale.

ACKNOWLEDGEMENTS

Funding for data collection and analyses used in this study was supplied by the following sources: The entire Cetacean and Turtle Assessment Program, including aerial and shipboard surveys, was funded by the Bureau of Land Management from late 1978 through mid-1982; the Marine

Mammal Commission provided funding for aerial survey flights over the GSC and off the southern US, and program support at URI during 1983 and 1984; the World Wildlife Fund-US provided funding for aerial survey flights off the southern US coast and provided URI program support in 1983. W. Rossiter of the Cetacean Society International donated funds to cover URI personnel expenses during the 1983 opportunistic aerial survey flights; and the Ocean Research and Education Society (ORES) invited observers from URI to participate in the 1982 and 1983 cruises. The US Coast Guard graciously permitted observers on several Offshore Law Patrol Flights.

I am grateful to P. Hammond and H. Whitehead for their assistance with the mark-recapture statistics; to J. Heltshe and S. Katona for their perspectives on applying these mark-recapture models to these right whale data; and to R.S. Armstrong, J.L. Chamberlin, G.P. Donovan, F. Fairfield, P. Hammond, J. Loy, J. Pearce, G. Stone, G. Waring and H. Winn for their valuable comments on the various versions of this manuscript. Special thanks are owed to F. Fairfield for his help in typing earlier versions of this manuscript, for his constructive and useful ideas and for his continued support during all phases of this study.

REFERENCES

- Bannister, J. 1990. Southern right whales off western Australia. Paper SC/A88/ID17 (published in this volume).
- Bailey, N.T.J. 1951. On estimating the size of mobile populations from capture-recapture data. *Biometrika* 38:293-306.
- Best, P.B. and Underhill, L.G. 1990. Estimating population size in southern right whales, *Eubalaena australis*, using naturally marked animals. Paper SC/A88/ID16 (published in this volume).
- Brownell Jr, R.L., Best, P.B. and Prescott, J.H. (eds.) 1986. *Right Whales: Past and Present Status. Rep. int. Whal. Commn* (special issue 10). International Whaling Commission, Cambridge, UK. i-vi+298pp.
- Burnham, K.P., Anderson, D.R. and Laake, J.L. 1980. Estimation of density from line-transect sampling of biological populations. *Wildl. Monogr.* 72:1-202.
- Chapman, D.G. 1951. Some properties of the hypergeometric distribution with applications to zoological censuses. *Univ. Calif. Publ. Statist.* 1:131-60.
- Donovan, G.P. and Gunnlaugsson, T. 1989. North Atlantic Sightings Survey 1987: report of the aerial survey off Iceland. *Rep. int. Whal. Commn* 39:437-41.
- Goodale, D.R. 1982. The temporal and geographical distribution of humpback, finback and right whale calves. Appendix C. pp. 1-68. In: H.E. Winn (ed.) *A Characterization of Marine Mammals and Turtles in the Mid- And North Atlantic Areas of the US Outer Continental Shelf, Annual Report for 1980. Nat. Tech. Inf. Serv., Ref. no. PB83149906.*
- Hammond, P.S. 1986. Estimating the size of naturally marked whale populations using capture-recapture techniques. *Rep. int. Whal. Commn* (special issue 8):253-82.
- Hiby, A.R., Ward, A. and Lovell, P. 1989. Analysis of the North Atlantic Sightings Survey 1987: aerial survey results. *Rep. int. Whal. Commn* 39:447-55.
- Jolly, G.M. 1965. Explicit estimates from capture-recapture data with both death and immigration - a stochastic model. *Biometrika* 52:225-47.
- Kenney, R.D., Winn, H.E. and Brown, C.W. 1986. Aerial surveys for right whales in the Great South Channel, Spring 1985. Final Rep. to [US] Nat. Mar. Fish. Serv., Northeast Fish. Center. 48pp.
- Kraus, S.D. 1985. A Review of the Status of Right Whales (*Eubalaena glacialis*) in the Western North Atlantic With a Summary of Research and Management Needs. [US] Nat. Tech. Inf. Serv., Ref. no. PB86154143.
- Kraus, S.D., Prescott, J.H. and Stone, G.S. 1984. Right whales (*Eubalaena glacialis*) in the western North Atlantic: A summary of research conducted from 1980-1984. Rep. to [US] Nat. Mar. Fish. Serv., Northeast Fish. Center, 49pp.

- Kraus, S.D., Moore, K.E., Price, C.A., Crone, M.J., Watkins, W.A., Winn, H.E. and Prescott, J.H. 1986. The use of photographs to identify individual North Atlantic right whales (*Eubalaena glacialis*). *Rep. int. Whal. Commn* (special issue 10):145-51 .
- Mead, J.G. 1986. Twentieth-century records of right whales (*Eubalaena glacialis*) in the northwestern Atlantic Ocean. *Rep. int. Whal. Commn* (special issue 10):109-19 .
- Payne, R., Brazier, O., Dorsey, E.M., Perkins, J.S., Rowntree, V.J. and Titus, A. 1983. External features in southern right whales (*Eubalaena australis*) and their use in identifying individuals. pp. 371-445. In: R. Payne (ed.) *Communication and Behavior of Whales*. AAAS Selected Symposium 76, Westview Press, Boulder, Colorado. 643pp
- Payne, R., Rowntree, V., Perkins, J.S., Cooke, J.G. and Lankester, K. 1990. Population size, trends and reproductive parameters of right whales (*Eubalaena australis*) off Peninsula Valdes, Argentina. Paper SC/A88/ID1 (published in this volume).
- Pennycuik, C.J. 1978. Identification using natural markings. pp. 147-59. In: B. Stonehouse (ed.) *Animal Marking: Recognition Marking in Animal Research*. MacMillan Press, London.
- Price, C.A. 1987. Distribution, movements and associations of individual right whales, *Eubalaena glacialis*, in the western North Atlantic based on a natural tag. Masters Thesis, Univ. Rhode Island, Narragansett, RI.
- Price, C.A. and Winn, H.E. 1982. Development of methodology for identifying individual North Atlantic right whales, *Eubalaena glacialis*, based on bonnet patterns and other markings, with a report on preliminary results. Appendix A. pp. 1-28. In: H.E. Winn (ed.) A Characterization of Marine Mammals and Turtles in the Mid- And North Atlantic Areas of the US Outer Continental Shelf, Annual Report for 1980. [US] Nat. Tech. Inf. Serv., Ref. no. PB83149906.
- Seber, G.A.F. 1965. A note on multiple recapture census. *Biometrika* 52:249-59 .
- Seber, G.A.F. 1982. *The Estimation of Animal Abundance and Related Parameters*. 2nd Edn. Griffin, London. 645pp.
- Seber, G.A.F. and Manly, B.F. 1985. Approximately unbiased variance estimation for the Jolly-Seber mark-recapture model: population size. pp. 363-71. In: B.J.T. Morgan and P.M. North (eds.) *Lecture Notes in Statistics: Statistics in Ornithology*. Springer-Verlag, Berlin.
- Watkins, W.A. and Schevill, W.E. 1979. Aerial observations of feeding behavior in four baleen whales, *Eubalaena glacialis*, *Balaenoptera borealis*, *Megaptera novaeangliae*, *Balaenoptera physalus*. *J. Mammal.* 60:155-63 .
- Watkins, W.A. and Schevill, W.E. 1982. Observations of right whales, *Eubalaena glacialis*, in Cape Cod waters. *Fish. Bull., US* 80:875-80 .
- Whitehead, H., Payne, R. and Payne, M. 1986. Population estimate for the right whales off Peninsula Valdes, Argentina, 1971-1976. *Rep. int. Whal. Commn* (special issue 10):169-71 .
- Winn, H.E. (ed.) 1982. A Characterization of Marine Mammals and Turtles in the Mid- And North Atlantic Areas of the US Outer Continental Shelf, Final Report. [US] Nat. Tech. Inf. Serv., Ref. no. PB83215855. 586pp.
- Winn, H.E. 1983. Development of a Right Whale Sighting Network in the Southeastern US. Report No. MMC-82/05 for the US Marine Mammal Commission. [US] Nat. Tech. Inf. Serv., Ref. no. PB84240548. v+12pp.
- Winn, H.E., Goodale, D.R., Hyman, M.A.M., Kenney, R.D., Price, C.A. and Scott, G.P. 1981. Right whale sightings and the right whale minimum count. pp. 1-37. In: H.E. Winn (ed.) A Characterization of Marine Mammals and Turtles in the Mid- And North Atlantic Areas of the US Outer Continental Shelf, Annual Report for 1979. [US] Nat. Tech. Inf. Serv., Ref. no. PB81243289.
- Winn, H.E., Scott, E.A. and Kenney, R.D. 1985. Aerial Surveys for Right Whales in the Great South Channel, Spring 1984. [US] Nat. Tech. Inf. Serv., Ref. no. PB85207926.
- Winn, H.E., Price, C.A. and Sorensen, P.W. 1986. The distributional biology of the right whale (*Eubalaena glacialis*) in the western North Atlantic. *Rep. int. Whal. Commn* (special issue 10):129-38.

Photographic Catchability of Individually Identified Minke Whales (*Balaenoptera acutorostrata*) of the San Juan Islands, Washington and the Monterey Bay Area, California

S. Jonathan Stern

*Department of Biology, San Francisco State University, 1600 Holloway Avenue,
San Francisco, CA 94132, USA*

*Current Address: Department of Ornithology and Mammalogy, California Academy of Sciences,
Golden Gate Park, San Francisco, CA 94118, USA*

Eleanor M. Dorsey

Long Term Research Institute, 191 Weston Road, Lincoln, MA 01773, USA.

Current Address: Conservation Law Foundation, 3 Joy Street, Boston, MA 02108, USA

Victoria L. Case

*Department of Biology, San Francisco State University, 1600 Holloway Avenue,
San Francisco, CA 94132, USA*

ABSTRACT

Population estimates based upon mark-recapture analysis require that individuals within that population be equally catchable. Individually identified minke whales of the San Juan Islands, Washington and the Monterey Bay area, California were tested for differences in photographic catchability for the purposes of individual recognition. A catchable surfacing was one in which the angle of the whale in relation to the boat and the distance between the whale and the boat allowed the taking of broadside photographs suitable for individual recognition. Catchability was quantified in two ways. The first measure was the number of surfacings until the first catchable surfacing in an encounter. The second measure was the proportion of catchable surfacings in an encounter. These indices were compared (1) between the two areas, (2) between individuals within an area and (3) within the encounter history of an individual.

The proportion of catchable surfacings was significantly higher in the Monterey Bay area than in the San Juan Islands, a surprising result given the rougher sea conditions in the former area. In addition, fewer surfacings were required to get the first catchable surfacing with Monterey Bay whales but the difference was not statistically significant. The probable explanation for the higher catchability in the Monterey Bay area is that those whales always travelled in a predictable direction, while San Juan Island whales milled in unpredictable directions, thus making proper positioning of the boat more difficult. Within areas, there were no significant differences in catchability between individuals and only a few differences between encounters with the same individual. This suggests that the assumption of equal catchability was not violated within areas, but may have been violated between areas, which further suggests that a population estimate for these whales would be unbiased by catchability differences if the estimate was stratified by study area.

Previously identified and unidentified whales from the Monterey Bay area were compared to determine differences in sea-conditions and number of opportunities to photograph whales. Significant differences were found in sea-state, swell height, duration of encounter, mean initial sighting distance of sequences, mean number of surfacings per surfacing sequence and proportion of catchable surfacings. There were no significant differences in the initial sighting distance, number of surfacing sequences per encounter and number of surfacings until first catchable surfacing. Although differences existed, it was possible to manoeuvre the boat into a position to photograph both identified and unidentified whales. Other factors may have influenced the ability to identify individuals.

INTRODUCTION

The size of a population and other parameters can be estimated from studies in which animals are captured, individually marked and released back into the population for possible subsequent recapture (e.g. Seber, 1982). The proportion of marked individuals in a second sample provides a population estimate, the Petersen Estimator, as follows:

$$\hat{N} = n_1 n_2 / m_2$$

where: \hat{N} is the estimated number of animals in the population; n_1 is the number of animals marked in the first sample; n_2 is the number of animals captured in the second sample; and m_2 is the number of animals marked in the initial sample which are recaptured in the second sample.

Both 'open' population models such as the Jolly-Seber method (Jolly, 1965; Seber, 1965) and 'closed' population models such as the Schnabel method (Schnabel, 1938)

require that the population being studied meet a number of assumptions. Two of these assumptions are that there is an equal probability of capture of all individuals in the population and that marking does not affect the catchability of an animal (Seber, 1982).

Violation of the assumption of equal catchability may result in an over- or an underestimation of the population size. If an animal becomes more difficult to capture after the initial capture, the under-representation of this individual during the subsequent sampling will result in an overestimation of the size of the population. Capture-prone individuals, on the other hand, will be over-represented in subsequent samples, resulting in an underestimation of the size of the population.

Previous mark-recapture studies of whales used numbered metal darts, called Discovery tags, which were fired into the dorsal musculature of a whale. If a marked whale was killed during whaling activities and the tag was

recovered, the date and position of marking were compared with the date and location of killing (Buckland and Duff, 1989). More recently, photographs of distinctive external characteristics have been used to recognise individual whales (e.g. Payne, 1972; Katona, Baxter, Brazier, Kraus, Perkins and Whitehead, 1979) to allow multiple 'recaptures' of individuals.

Hammond (1986) reviewed the use of photographic identification of whales and its applicability to population estimates based upon mark-recapture analysis. He divided the process of photographic identification as a method of marking whales into three component parts, each of which has a potential for variability. Variability may be introduced by differences in: (1) the probability of sighting a whale in the area of operation; (2) the probability of taking an identification photograph of a whale once it has been detected; and (3) the probability of identifying an individual from the photographs taken.

This paper is an attempt to quantify the probability of taking an identification photograph, 'photographic catchability', in minke whales (*Balaenoptera acutorostrata*). We examine the behaviour of individual whales in relation to the research vessel, how that behaviour affects the ability to manoeuvre a vessel in such a position to take photographs adequate for photographic identification, and whether photographic catchability varies by area, individual or encounter. In addition, we compare identified and non-identified whales to explore factors affecting identifiability, including sea-conditions, which affect the ability to sight and follow whales.

METHODS

Minke whales were observed in the waters of the San Juan Islands, Washington, during August 1984 and the waters of Monterey Bay and adjacent coastal waters off central California from July-September in both 1985 and 1987 (Fig.1). The boats used for these studies were a 4.6m *Reinell* with a 60hp *Suzuki* outboard motor in the San Juan Islands and a 5.2m *Boston Whaler* with a 70hp *Johnson* outboard motor in the Monterey Bay area. There were three observers on board the boat in the San Juan Islands and one during work in Monterey.

Observers searched for whales with the boat either stopped with the engine off or slowly moving. Cues for ascertaining the presence of a whale in an area were both visual and acoustic. The visual cues included observation of the body of the whale, a splash, a 'slick' or 'footprint' of upwelled water from the tailflukes or disturbed water where a whale recently surfaced. Minke whales in these study areas generally did not have a visible blow. Acoustic cues were either the sound of the blow of the whale or the sound of a splash from a vigorous surfacing. Acoustic cues were less useful when the boat was moving and sounds were masked by the sound of the engine, when the whale was downwind of the boat or when conditions were above sea-state 3 on the Beaufort scale.

Data were gathered in a series of encounters, where an encounter was defined as a series of surfacing sequences during which one whale served as the focal animal. A surfacing sequence was defined as a series of surfacings of a whale, with consecutive surfacings less than two minutes apart. The termination of a surfacing sequence was usually signalled by an arched tailstock as the whale dived at a steeper angle for a longer dive. An encounter was terminated when the focal whale was lost, left for another

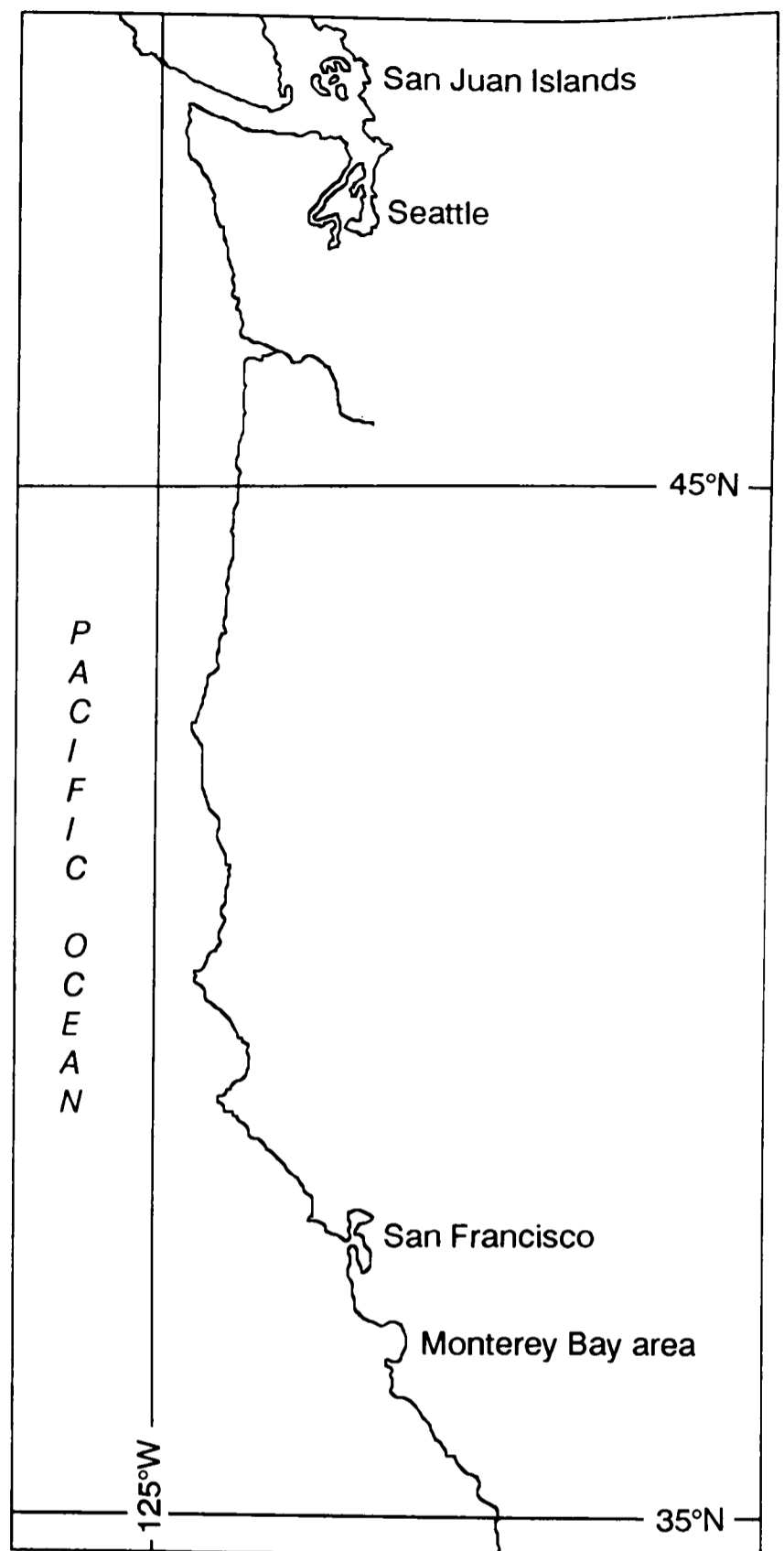

Fig. 1. Location of the two study sites along the west coast of North America.

whale or when observations were terminated. A whale was considered lost if it was not seen for fifteen minutes. Data recorded for each surfacing included time to the second, type of surfacing, direction of the whale, distance from the boat, heading of the boat relative to the whale and heading of the whale relative to the boat. Minke whales in both areas tended to be solitary, and although up to six whales were seen within a feeding area in the San Juan Islands at one time, the whales usually acted independently of one another. Two or three whales were seen swimming together, on occasion, within 2-3 body lengths. It was difficult to be certain of the identity of each whale on each surfacing on these occasions, so only observations of single whales were used for this analysis.

Whales exhibited different surfacing patterns in the two areas and this affected techniques used to locate, approach and follow the whales. Whales in the San Juan Islands used for this analysis milled about in a limited area without proceeding in a predictable direction from one surfacing sequence to the next. Under these conditions, the motor of

the boat was usually shut down during a long dive, so that audible cues could be used to detect the next surfacing. Sea-conditions in the San Juan Islands, an inland archipelago, were generally calm with a swell of less than 0.3m and a sea-state of 2 or less on the Beaufort scale.

Whales in the Monterey Bay area did not mill in a limited area. Rather, they followed the coastline within a 3.2km corridor along shore, heading parallel to shore, often at the edge of the kelp beds. The technique used in Monterey was to cruise slowly at a speed of approximately 2–3 knots. This was for three reasons. First, the whales tended to swim at this speed in a predictable direction. Second, slow cruising allowed manoeuvring to minimise the amount of time spent in the troughs of swells. Swells were generally 0.9–1.5m plus an additional 0.6–0.9m of waves (Beaufort 3–4). Since minke whales exposed no more than about 1m in height of back and dorsal fin for a period of about 3 seconds or less on a surfacing, it was possible to miss a surfacing behind a swell. The periodicity of swells varied from 5 to 20 seconds. The third reason was that since sea-state was generally at least 3 on the Beaufort scale, audible cues were rarely useful due to ambient noise caused by the wind on the surface of the water.

In either area, if a whale surfaced more than 100m from the boat, it was approached initially as fast as possible, given the sea-conditions. The boat was slowed about 50m before reaching the position of the last surfacing and the direction changed to parallel the direction of travel of the whale. The persistence of the slick or 'footprint' on the surface was often of help in determining the position of previous surfacings of the whales. The boat further slowed to no more than 3 knots when a surfacing was anticipated and the whale was photographed upon surfacing.

Single lens reflex cameras with either a 300mm telephoto or 80–200mm zoom lens were used to photograph the whales. Minke whales were identified by the broadside profile of the dorsal fin, distribution of small oval scars and swaths of pale pigmentation as described by Dorsey (1983) and by Dorsey, Stern, Hoelzel and Jacobsen (1990). Individual whales were given an identification number prefaced with an S if from the San Juan Islands or an M if from the Monterey Bay area.

Catchability was defined as the probability of positioning the research boat in such a manner that photographs suitable for individual identification could be taken. There are several factors that must be met for a suitable photograph, such as distance to the whale, heading of the whale relative to the research vessel, position of the photographer relative to the sun, stability of the platform and preparedness and skill of the photographer. The first two factors are the ones of interest when considering how the behaviour of the whale affects its catchability. The distance between the boat and whale and the angle of the whale relative to the boat were estimated by the same person (SJS) in both study areas. The distance of the whale from the boat was assigned to one of five categories: 0 to 10m, 11–25m, 25–50m, 51–100m, and greater than 100m. The mean distance in each category was used for analysis, i.e. 5m, 18m, 38m, 76m and 100m, respectively. The maximum distance between the boat and whale for a suitable photograph, given the size of the lenses used, was 50m. The heading of the whale relative to the boat was described in the following manner. A clock was imagined around the whale with 12, 3, 6 and 9 o'clock positions corresponding to the tip of the rostrum, right flank, tail flukes and left flank respectively (Fig.2). The hour of the

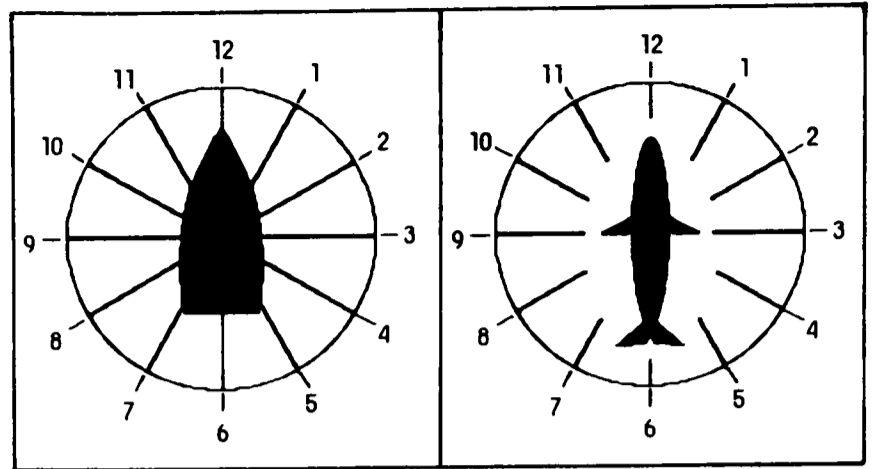

Fig. 2. The method used to determine the orientation of whales in relation to the boat. A clock is imagined around the whales with 12, 3, 6 and 9 o'clock referring to front, right, rear and left, respectively. The reading is taken off the part of the body of the whale which is in line with the observer. The whale in this figure is in the 9 o'clock orientation with respect to the boat.

clock through which the line of sight to the whale passed was recorded for each surfacing to indicate the orientation of the whale relative to the vessel. Suitable positions for taking photographs were those from the angles of 2 to 4 o'clock on the right side and 8 to 10 o'clock on the left side of the whale. Both the distance requirement and the orientation requirement had to be met for a whale to be considered catchable on a particular surfacing.

Catchability was quantified in two ways. The first measure was the number of surfacings in an encounter until the boat was first positioned for suitable photographs. The second measure was the proportion of catchable surfacings in the encounter, i.e. the number of catchable surfacings in an encounter divided by the total number of surfacings in that encounter. The proportion of catchable surfacings ranged from 0 (if no surfacings in an encounter were catchable) to 1 (if all surfacings in an encounter were catchable). Since there were at least two encounters with most individuals, mean values were used for comparisons between individual whales.

To test for differences over time in the proportion of catchable surfacings for all of the encounters with a given individual, the following test statistics were used, depending on the number of encounters. If there were 3 or more encounters with an individual, the statistic was as follows (Zar, 1984):

$$X^2 = \sum [(c_i - t_i p_i)^2 / t_i p_i q_i]$$

where: t_i = surfacings for the i th encounter; c_i = catchable surfacings for the i th encounter; $p_i = \sum (c_i / t_i)$; and $q_i = 1 - p_i$. For individuals where only 2 encounters were observed the test statistic was (Zar, 1984):

$$Z = (p_1 - p_2) / \sqrt{[(p_1 q_1 / n_1) + (p_2 q_2 / n_2)]}$$

where p and q are the same notation as above. Both of these test statistics have a chi-square distribution.

A one-way ANOVA was used to determine differences between individuals. The proportion data were arcsine transformed first since they form a binomial rather than a normal distribution (Zar, 1984). The possibility of significant trends over time in both first catchable surfacing and proportion of catchable surfacings for an individual was tested using simple linear regression.

In order to examine what factors influence success in identifying individuals, encounters with identified whales were compared to encounters with unidentified whales with respect to sea conditions and a number of variables of

the encounter. These variables were: duration of encounter, number of surfacing sequences, mean number of surfacings per sequence, proximity of initial sighting, mean boat-to-whale distance at the beginning of each sequence and the two measures of catchability – proportion of catchable surfacings and number of surfacings until first catchable surfacing. Only Monterey Bay whales were used for several reasons. First, sea-state and swell height were more variable in the Monterey Bay area than in the San Juan Islands. Second, in Monterey Bay, encounters always ended by losing the whale, while in the San Juan Islands, whales were sometimes left to approach and follow other whales in the area or left for other reasons, thus biases potentially affecting identification success were present.

Third, whales in Monterey consistently swam parallel to the shore, so there was no potential bias due to differences in swimming behaviour.

To further examine the role of sea conditions, the effect of sea state on the above encounter variables was tested for using simple linear regression for all identified and unidentified whales in Monterey Bay.

RESULTS

A total of 755 surfacings of six known individuals from 39 encounters were analysed for San Juan Islands whales. The whales were categorised as catchable on 251 of these surfacings based upon the criteria discussed earlier. The

Table 1

Summary of the data for each whale by encounter. The initial letter (S = San Juan Islands, M = Monterey Bay) denotes the area. The number to the left of the decimal place indicates the individual whale and the number to the right of the decimal place indicates the encounter for that whale.

Encounter	First catchable surfacing	Proportion of catchable surfacings	Total no. of surfacings	Encounter	First catchable surfacing	Proportion of catchable surfacings	Total no. of surfacings
S 2.1	5	0.18	11	M 1.1	2	0.40	35
S 2.2	4	0.17	29	M 3.1	4	0.36	11
S 2.3	2	0.64	11	M 3.2	3	0.59	17
S 2.4	4	0.17	12	M 3.3	5	0.75	51
S 2.5	6	0.19	16	M 3.4	1	0.67	51
S 2.6	4	0.49	43	M 3.5	3	0.43	21
S 2.7	2	0.54	13	M 3.6	1	0.55	11
S 2.8	5	0.25	8	Mean	2.83	0.56	27.0
Mean	4	0.33	17.88				
S 3.1	3	0.45	11	M 4.1	1	0.43	7
S 3.2	5	0.17	12	M 4.2	10	0.33	21
S 3.3	3	0.13	8	Mean	5.5	0.38	14.0
S 3.4	1	0.47	17	M 5.1	4	0.38	8
Mean	3	0.31	12.0	M 5.2	4	0.27	15
S 13.1	3	0.30	71	M 5.3	3	0.27	15
S 13.2	3	0.83	6	M 5.4	1	0.75	4
Mean	3	0.57	38.5	M 5.5	1	0.83	6
S 16.1	4	0.27	30	Mean	2.6	0.50	9.6
S 16.2	4	0.38	16	M 6.1	1	0.53	15
Mean	4	0.33	23.0	M 6.2	1	0.61	18
S 26.1	6	0.24	50	M 6.3	2	0.67	51
S 26.2	11	0.32	79	M 6.4	1	0.25	8
S 26.3	2	0.40	15	Mean	1.25	0.52	23.0
S 26.4	4	0.33	21	M 7.1	3	0.40	5
S 26.5	1	0.44	9	M 7.2	2	0.56	9
S 26.6	3	0.50	4	Mean	2.5	0.48	7.0
S 26.7	2	0.17	12	M 9.1	1	0.83	6
S 26.8	2	0.57	7	M 9.2	5	0.43	23
S 26.9	1	0.71	7	M 9.3	2	0.50	4
Mean	3.56	0.41	22.67	M 9.4	2	0.50	2
S 28.1	3	0.34	38	Mean	2.5	0.57	8.75
S 28.2	2	0.41	63	M11.1	4	0.54	26
S 28.3	2	0.50	4	M15.1	3	0.38	23
S 28.4	4	0.20	25	M16.1	3	0.57	7
S 28.5	3	0.40	5	M17.1	3	0.63	8
S 28.6	1	0.25	4	M17.2	4	0.67	22
S 28.7	3	0.57	7	Mean	3.5	0.65	15.0
S 28.8	7	0.24	17				
S 28.9	2	0.38	8				
S 28.10	3	0.30	20				
S 28.11	2	0.20	20				
S 28.12	4	0.29	7				
S 28.13	4	0.40	10				
S 28.14	6	0.22	9				
Mean	3.29	0.34	16.63				

mean number of surfacings per encounter was 19.4 ± 18.6 with a range of 4 to 79. The number of surfacings analysed for identified whales in Monterey Bay area was 500 from 11 individual whales in 29 encounters. Whales were catchable on 270 of these surfacings. The mean number of surfacings per encounter was 17.2 ± 14.1 with a range of 2 to 51. The data for all encounters of all individuals are presented in Table 1. The success of identifying whales once sighted was about 80% for both study areas (Dorsey *et al.*, 1990).

Comparison between areas

About three surfacings were required for a whale to be catchable for the first time in an encounter. The mean number of surfacings before the first catchable surfacing was higher for San Juan Island whales than Monterey Bay whales ($3.5 \pm SD 1.95$ and $2.8 \pm SD 2.76$, respectively), but the difference was not statistically significant ($F=2.38$; 67 df; $p=0.128$).

Encounters with whales in the Monterey Bay area had a significantly higher proportion of catchable surfacings than encounters with whales in the San Juan Islands (51.9% vs 35.2%, respectively) ($F=15.3$; 67 df; $p < 0.0002$). For both of these comparisons between the areas, only identified whales were considered.

Comparison between whales within an area

Individual whales did not exhibit significant differences in the number of surfacings until the first catchable surfacing in either the San Juan Islands ($F=0.221$; 38 df; $p=0.951$) or in Monterey Bay ($F=0.688$; 28 df; $p=0.723$). There were also no significant differences in the proportion of catchable surfacings between whales in the San Juan Islands ($F=1.06$; 38 df; $p=0.402$) or in Monterey Bay ($F=0.361$; 28 df; $p=0.948$).

Catchability of an individual over time

Most individuals did not show a significant change over time in either measure of catchability. Of the eight whales encountered three or more times, only two exhibited significant trends in the number of surfacings until first catchable surfacing. In both cases (whales S26 and M5, $p < 0.05$ for each), there was a negative trend. Of the 13 whales encountered twice or more, only three showed a significantly unequal proportion of catchable surfacings between encounters (whales S2 and S13, $p < 0.01$, and whale M6, $p < 0.025$). However, these changes did not constitute any consistent trends over time.

Identified vs Unidentified whales in Monterey Bay

Thirty one encounters with identified whales were compared with thirteen encounters with unidentified whales in the Monterey Bay area to examine the extent to which various encounter variables and sea conditions related to the success in identifying individuals. With one exception, identified and non-identified whales differed with respect to the examined factors (Table 2). Identified whales were observed in seas with significantly lower sea state and swell height than non-identified whales, and identified whales had significantly longer encounters with a higher proportion of catchable surfacings, more surfacings per sequence and closer surfacings at the start of each sequence. In addition, the first sighting in the encounter was nearer to the boat and there were more surfacing sequences per encounter for identified whales, but these latter two differences were not statistically significant.

Table 2
Comparison of identified and unidentified whales.

Factor	Identified whales n = 31		Unidentified whales n = 13		p
	Mean	SD	Mean	SD	
Mean number of surfacings per sequence	3.49	(1.27)	2.08	(0.95)	$p < 0.001^1$
Sea state (Beaufort scale)	2.45	(0.93)	3.15	(0.80)	$p < 0.01^2$
Distance at start of each sequence (m)	50.77	(14.56)	67.20	(22.21)	$p < 0.01^2$
Proportion of catchable surfacings ³	46.14 0.519	(9.87)	29.71 0.246	(30.37)	$p < 0.02^1$
Duration of encounter (min)	31.16	(28.67)	12.00	(13.4)	$p < 0.03^1$
Swell height (ft)	2.90	(1.42)	3.85	(1.28)	$p < 0.05^1$
Number of surfacing sequences per encounter	5.10	(4.34)	2.62	(2.33)	$p > 0.05^1$
First sighting distance (m)	56.52	(26.42)	70.17	(28.22)	$p > 0.1^2$
Number of sightings until first catchable surfacing	2.76	(1.90)	2.77	(2.98)	$p > 0.95^1$

¹ From one-way ANOVA.

² From Mann-Whitney U test.

³ Proportion data were arcsine transformed before one-way ANOVA. Reported means and standard deviations have been reconverted to untransformed values.

Only the number of surfacings until the first catchable surfacing did not differ for identified and non-identified whales.

Among identified whales in Monterey Bay, only two variables showed significant trends according to sea state: duration of encounter ($p < 0.03$) and first sighting distance ($p < 0.001$) both decreased as sea state increased. The number of surfacing sequences per encounter, which is probably positively correlated with duration of encounter, tended to decrease as well with increasing sea state ($p=0.08$). No clear trends with sea state appeared for any of the other variables examined (mean number of surfacings per sequence, mean distance at the start of each sequence, proportion of catchable surfacings, and number of surfacings to first catchable surfacing). Among unidentified whales in Monterey Bay, none of the seven encounter variables examined showed any trend with sea state.

DISCUSSION

The greatest source of error in mark and recapture analyses has been attributed to unequal catchability (Caughley, 1977). The undetected violation of this assumption can bias the estimation of the size of a population. However, models exist which allow for spatial or temporal variation, different probabilities of capture over time for an individual animal and different

probabilities for different individual animals. The analysis becomes more complex as two or three sources are considered at once. Therefore, it is important to determine the sources of heterogeneity to be able to choose appropriate models (Otis *et al.*, 1978).

In this study, photographic catchability of minke whales differed significantly between the two study areas when measured by proportion of catchable surfacings. Within each area, however, the assumption of equal catchability appeared to hold reasonably well, since there were no significant differences among individuals in either measure of catchability, and only a few significant differences among encounters with the same individual. These results suggest that population estimates could be made, assuming equal catchability, as long as a separate estimate was made for each study area. Other observations of these whales reported by Dorsey *et al.* (1990), however, reveal a strong pattern of spatial segregation within each area that might require, for population estimates assuming equal catchability, a further stratification of the data into two sub-areas in the Monterey Bay area and three sub-areas in the San Juan Islands.

The greater catchability of whales in the Monterey Bay area is a surprising result, given the rougher sea-conditions due to its exposed location. It would appear that the straight-line swimming behaviour, which made it possible to predict the approximate location of subsequent surfacings, more than compensated for the rough seas. Whales in the San Juan Islands were occasionally observed while travelling in a predictable direction and were very easy to photograph at those times but data necessary for the quantification of catchability were not collected during any of those encounters.

Age-related differences in catchability have been noted for some species such as the humpback whale, *Megaptera novaeangliae* (Perkins, Balcomb, Nichols, Hall, Smultea and Thurmsen, 1985). In their study, the angle of presentation of the flukes was less in younger animals which meant that there was a differential probability of identification from photographs. Young minke whales have been reported to be curious about slow-moving or stationary boats (Mitchell, 1974) and such curiosity might be expected to increase the photographic catchability of young minke whales.

Our single encounter with a curious young minke whale, however, shows that the opposite can be the case. M15 was identified only once and swam under the boat much of the time, thus allowing a length estimate by comparison with landmarks on the boat. It was about 4.3m in length, similar to the sizes reported for recently weaned calves from the Southern Hemisphere: 4.42m – Williamson (1975); 4.57m – IWC (1979); and 4.88m – Lockyer (1979). This was the only reliable estimate of age of any whale in either study area. The majority of the time the whale was underwater, it was swimming on its side, under the boat, at a depth of 1.5m. In order to surface, the whale would veer away from the boat, presenting an angle unsuitable for an identification photograph. Thus the whale was very difficult to 'catch' photographically in spite of its proximity to the boat.

It is likely that the mean number of surfacings required for first catchable surfacing was as low as it was (3.5 in the San Juan Islands and 2.8 in the Monterey Bay area) for two reasons in addition to the speed, manoeuvrability and fast acceleration of the research vessels. First, the potential sighting range from the research craft was low, because the

whales generally did not have a visible blow and the height of the eyes of the observer above the water was only about 2m, so whales were generally close to the boat when first sighted thereby reducing time needed for pursuit. It is probable that from a taller platform, minke whales could have been spotted from a greater distance so that the number of surfacings to first catchable surfacing would have increased accordingly. Second, searching was conducted in areas where whales tended to concentrate – a shallow bank in the San Juan Islands and a strip about 3km wide along the shore near Monterey Bay, again increasing the likelihood of a surfacing close to the boat.

In the comparison of identified and non-identified whales in the Monterey Bay area, it is noteworthy that only one of our two measures of photographic catchability showed a significant difference – the proportion of catchable surfacings. The fact that the other measure – the number of surfacings to first catchable surfacing – was identical for identified and non-identified whales raises the possibility that this measure of catchability is not a useful one, given that the first sighting distance was similar in both cases. On average, 25% of the surfacings of unidentified whales were at a suitable distance and angle for an identification photograph. Because the duration of the encounter, distance at the start of the encounter, distance at the start of each sequence and mean number of surfacings per sequence were significantly different between identified and non-identified whales, there were fewer overall opportunities to photograph the unidentified whales. We have not analysed further the reason for the failure to identify these whales, i.e. whether photographs were not taken, or were taken but were inadequate in some way.

The three highly significant differences between identified and non-identified whales were the mean number of surfacings per surfacing sequence, mean distance at the start of each sequence and sea-state. Since neither of the first two factors showed any clear trend with sea-state, it is possible that differences in behaviour were partly responsible for the instances when whales were not successfully identified.

The data presented here were taken from a study for which the mean goal was not to make population estimates, but rather to describe the behaviour and occurrence of individual whales. We have not in fact calculated population estimates for either study area because the total number of animals identified was low in each area (30 in the San Juan Islands, 17 in the Monterey Bay area) and the resighting rate was relatively high, especially in the San Juan Islands (see Dorsey *et al.*, 1990). Because of this, we believe that we have identified most of the available population in each area. We have performed the analysis presented here, however, as an exercise to quantify and test the assumptions of equal catchability in mark-recapture studies. Of course, in the end, what can cause a bias in mark-recapture population studies is not simply how difficult it is to photograph an animal, but whether or not the degree of difficulty leads the researcher to abandon the attempt.

ACKNOWLEDGEMENTS

We would like to thank the Friday Harbour Laboratories of the University of Washington for logistical support and the National Geographic Society for funding for work conducted in the San Juan Islands. Rus Hoelzel kindly

donated the use of his boat. Tamara Osipoff and Ray Fowler assisted in the field. The Department of Biology at San Francisco State University and Hopkins Marine Station of Stanford University provided invaluable logistical support for the field work conducted in Monterey Bay. The US Coast Guard Group Monterey provided dock space as well other logistical support. Alan Baldrige of Hopkins Marine Station was also very helpful to the work conducted in the Monterey Bay area. Eric Carlson helped with computer programming. SJS would like to thank Dr. Hal Markowitz, his thesis advisor. We would also like to thank Dr. Ralph Larson and two anonymous reviewers for their helpful suggestions and comments on the manuscript.

REFERENCES

- Buckland, S.T. and Duff, E.I. 1989. Analysis of Southern Hemisphere minke whale mark-recovery data. *Rep. int. Whal. Commn* (special issue 11): 121-43.
- Caughley, G. 1977. *Analysis of Vertebrate Populations*. Wiley and Sons, New York.
- Dorsey, E.M. 1983. Exclusive adjoining ranges in individually identified minke whales (*Balaenoptera acutorostrata*) in Washington State. *Can. J. Zool.* 61(1): 174-81.
- Dorsey, E.M., Stern, S.J., Hoelzel, A.R., and Jacobsen, J. 1990. Minke whales (*Balaenoptera acutorostrata*), from the west coast of North America: individual recognition and small-scale site fidelity. Paper SC/A88/ID21 (published in this volume).
- Hammond, P.S. 1986. Estimating size of naturally marked whale populations using capture-recapture techniques. *Rep. int. Whal. Commn* (special issue 8):253-82.
- International Whaling Commission. 1979. Report of the Special Meeting on Southern Hemisphere Minke Whales, Seattle, 1978. *Rep. int. Whal. Commn* 29: 349-58.
- Jolly, G.M. 1965. Explicit estimates from capture-recapture data with both death and immigration - a stochastic model. *Biometrika* 52: 225-47.
- Katona, S., Baxter, B., Brazier, O., Kraus, S., Perkins, J. and Whitehead, H. 1979. Identification of humpback whales by fluke photographs. pp. 33-44. In: H.E. Winn and B.L. Olla (eds), *Behavior of Marine Animals. Vol. 3. Cetaceans*. Plenum Press, N.Y.
- Lockyer, C. 1979. Review (in minke whales) of the weight/length relationship and the Antarctic catch biomass and a discussion of the implications of imposing a body length limitation of the catch. *Rep. int. Whal. Commn* 29: 396-74.
- Mitchell, E.D. 1974. Present status of northwest Atlantic fin and other whale stocks. pp. 419. In: W.E. Schevill (ed.). *The Whale Problem: A Status Report*. Harvard Univ. Press, Cambridge, MA. 419pp.
- Otis, D.L., Burnham, K.P., White, G.C. and Anderson, D.R. 1978. Statistical inference from capture data on closed animal populations. *Wildl. Monogr.* 62:1-135.
- Payne, R.S. 1972. Swimming with Patagonia's right whales. *Natl. Geogr.* 142: 576-87.
- Perkins, J.S., Balcomb, K.S., Nichols, G., Hall, A.T., Smultea, M. and Thurmer, N. 1985. Status of the West Greenland humpback whale feeding aggregation, 1981-1983. *Rep. int. Whal. Commn* 35: 379-83.
- Schnabel, Z.E. 1938. The estimation of the total fish population of a lake. *Am. Math. Monogr.* 45: 348-52.
- Seber, G.A.F. 1965. A note on the multiple recapture census. *Biometrika* 52: 249-59.
- Seber, G.A.F. 1982. *The Estimation of Animal Abundance and Related Parameters*. Griffin, London. 2nd Edition, 654pp.
- Williamson, G.R. 1975. Minke whales off Brazil. *Sci. Rep. Whales Res. Inst., Tokyo.* 27:37-59.
- Zar, J.H. 1984. *Biostatistical Analysis*. 2nd Ed. Prentice-Hall, New Jersey. 716pp.

Heterogeneity in the Gulf of Maine? Estimating Humpback Whale Population Size when Capture Probabilities are not Equal

P.S. Hammond

*Sea Mammal Research Unit, Natural Environment Research Council, c/o British Antarctic Survey,
High Cross, Madingley Road, Cambridge, CB3 0ET, UK.*

ABSTRACT

The problem, common in capture-recapture studies, of capture probabilities being unequal as a result of inherent individual variability (heterogeneity) is reviewed and addressed using the Gulf of Maine humpback whale photo-identification data. A method of identifying and addressing heterogeneity in capture-recapture data, presented by Cormack (1985), is applied to these data. Results show that Cormack's method identifies heterogeneity in the data and that this can be accounted for to produce a better estimate of population size. The most likely reason for the estimated increase in the size of the Gulf of Maine humpback population during the last 10 years is identified as a combination of site specificity and increasing coverage of the area, which has resulted in an effective reduction in heterogeneity.

INTRODUCTION

Of the population parameters which can be estimated from individual recognition data, population size has received the most attention. There are two reasons for this. One is that the number of animals in a population is often the first piece of information researchers (and managers) would like to have. It is a fundamental descriptor of the population. The other is that abundance is superficially the easiest population parameter to estimate from such data. What could be simpler than calculating a Petersen estimate for two seasons of photo-identification data? The indirect answer is, of course, that although population size may be easy to calculate, the value of the results of such calculations depends crucially upon how well the assumptions of the applied model are met.

Hammond (1986) has reviewed the estimation of cetacean population size using individual recognition data and devoted several pages to possible violations of the central assumption that, within any one sampling occasion, all animals should have an equal probability of capture. He also recognised that, in practice, unequal catchability was likely to be a fact of life in all photo-identification studies of whales. This paper reviews the underlying reasons for this and describes in more detail how one major problem, namely heterogeneity of capture probabilities, can be identified and addressed.

UNEQUAL PROBABILITY OF CAPTURE

The basic capture-recapture models, the Petersen, Schnabel and Jolly-Seber models (see e.g. Begon, 1979; Seber, 1982; Hammond, 1986), make the assumption that at any one sampling occasion all animals have an equal chance of being captured. There are a number of reasons why this may not be the case.

Capture probabilities are likely to vary from one sampling occasion to another but the basic models allow for this. What these general models do not allow is for the catchability of an individual to vary from sample to sample. In the extreme case animals may be absent from the sample area on one or more occasions. This is known as temporary

emigration. In the field, temporary emigration could manifest itself not only by animals being physically absent but also by a combination of site specificity within the sample area and a limitation of sampling effort. Closed population models do not allow emigration of any kind. Open population models, such as the Jolly-Seber, treat emigration in the same way as death, i.e. when an animal emigrates it has gone forever. Temporary emigration can be accounted for only if independent data exist to assess its effects or if the pattern of presence/absence can be explicitly modelled (e.g. Best and Underhill, 1990).

Probability of capture may be a function of a biological characteristic of the animal, such as age or sex. Perkins, Balcomb, Nichols, Hall, Smultea and Thumser (1985) showed that different age groups of humpback whales off West Greenland exhibited different fluking behaviour which affected the probability of obtaining a usable photograph. Models have been proposed which allow catchability to vary with age (e.g. Pollock, 1981; Stokes, 1984) but they require that all animals can be placed with certainty into the correct age class. Such models are unlikely to be useful in studies of whales because sampled animals cannot be aged unless they were first seen as calves.

Probability of capture could also vary in response to the process of capture and marking. These responses occur, for example, in studies of small mammals where animals become 'trap-happy' or 'trap-shy' and Otis, Burnham, White and Anderson (1978) have presented models which allow catchability to vary depending upon whether or not an individual had previously been captured. This situation is unlikely to occur in photo-identification studies of whales, however, because of the nature of 'capturing' the animals.

Perhaps the most important way in which catchability can vary is as a result of inherent individual differences in behaviour. This individual variation is often referred to as heterogeneity. There is no doubt that heterogeneity is common in capture-recapture studies. Roff (1973) found that in over 40 studies where catchability was investigated, less than a quarter indicated equal catchability to be the case. Furthermore, the tests used had little power to reject

the null hypothesis of equal catchability. In a novel capture-recapture experiment on taxicabs in Edinburgh, Carothers (1973a) found that the standard test for heterogeneity failed to reject the null hypothesis of equal catchability although a more powerful test (possible because the total number of taxicabs was known) showed that heterogeneity was present.

Heterogeneity in capture-recapture data causes a negative bias in estimates of population size. To demonstrate this, take an extreme example. Let all the whales in a population have the same probability of being captured, except one group which is always seen and another group which is never seen. The group which is never seen will simply not be included in the population estimate which will therefore be an underestimate. The group seen on every sampling occasion will cause the proportion of marked animals in the sample to be overestimated which also leads to an underestimate in population size. Carothers' (1973a) experiment found the number of taxis to be underestimated by up to 30%. Even when a sampling scheme devised to ensure equal probability of capture was implemented, population size was still underestimated by up to 15%. There is no doubt that heterogeneity has a significant effect upon estimates of population size.

Simulation studies by Gilbert (1973) and Carothers (1973b) corroborate this and also show that the magnitude of the negative bias is related to the coefficient of variation of mean capture probability. That is, the greater the range of capture probabilities, the greater the negative bias in population estimates. There is no suitable estimator of population size from open population models when capture probabilities are allowed to vary as a result of heterogeneity (Pollock, 1975). Otis *et al.*, (1978) have presented an estimator for closed populations but it is unreliable if a large proportion of animals have a very low probability of capture; a common occurrence in capture-recapture data for whales. This means that it is important to look at ways in which the effects of heterogeneity and the heterogeneity itself can be reduced.

IDENTIFYING HETEROGENEITY AND MINIMISING ITS EFFECTS

One way to identify heterogeneity is to investigate the pattern of residual differences between the observed and predicted number of animals with each capture history plotted against the number of times the animals were seen, as suggested by Cormack (1985). A capture history is simply a record of when an animal was and was not seen during the course of the study. For example, in a six sample experiment, an animal could be seen in the first sample, seen in the second sample, not seen in the third, fourth and fifth samples and then seen again in the sixth. There may be several animals with this capture history. Capture-recapture models find the set of parameters which cause the number of animals with each capture history predicted by the model to resemble most closely the observed numbers. The residual difference between the predicted and observed number indicates how well the model has performed for any particular capture history. If the capture histories are grouped together according to how many times the animals were seen, we can look at how well the model performed in predicting the number of animals seen a given number of times.

If capture probabilities are equal at any one sampling occasion the model should perform equally well for all capture histories, regardless of how many times the animals were seen. If heterogeneity is present so that some animals always have a greater than average chance of being seen, we may expect the observed data to reveal more animals seen many times than predicted by a model which assumes equal catchability. Similarly, there will be some animals which always have a lower than average chance of being seen and we may expect to observe more animals seen only once or a few times than predicted by the model. In both these cases, for each capture history, we would expect the residual difference between the number of animals observed and that predicted to be positive. To balance this effect, we would expect capture histories with animals seen an intermediate number of times to have fewer animals observed than predicted by the model and consequently to have negative residuals. So, if the residuals for each capture history are plotted on a graph with capture histories grouped by the number of times the animals were seen, we would expect to see a characteristic 'U' shape (Cormack, 1985). This pattern need not be symmetrical. For example, if heterogeneity is primarily a result of one group of animals having a higher capture probability than all the others, the pattern of residuals will be more like a 'J' shape.

To investigate this, I have used data for North Atlantic humpback whales presented by Katona and Beard (1990), and a computer program written by Cormack (1985) for use with the statistical package GLIM (McCullagh and Nelder, 1983). To demonstrate the effect of equal capture probabilities I fitted the Jolly-Seber model to the data from the Gulf of St Lawrence collected in the period 1982-85. There were 116 individual animals identified with 28 seen more than once. Fig. 1 shows the residual difference between the observed and predicted number of animals with each capture history plotted against the number of times the animals were seen, as described above. The pattern shows that there were neither more animals than expected seen one or four times, nor less than expected seen two or three times.

To demonstrate the effects of heterogeneity, I fitted the Jolly-Seber model to the data from the Gulf of Maine, collected in the period 1979-86. These data comprise 464 different individuals, many of which have been seen more

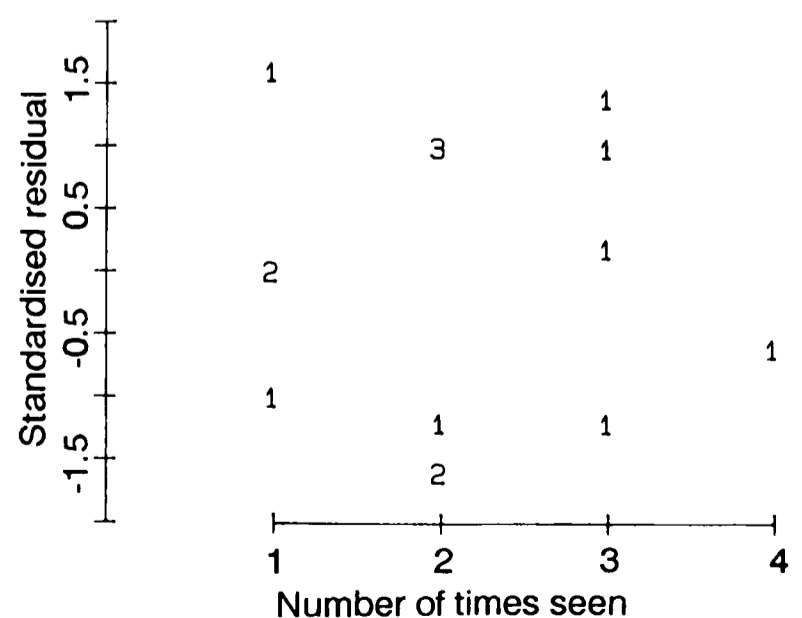

Fig. 1. Residual difference between and predicted number of animals for each capture history plotted against the number of times the animals were seen for Gulf of St Lawrence humpback whales, 1982-85. Points labelled '1', '2', '3', etc represent one, two, three, etc capture histories.

than once and 18 of which have been seen in all eight years. Fig. 2 shows the residuals plotted against number of times seen. The 'U' shape of the plot is largely a result of the unexpectedly high number of animals seen every year; many more than the two animals predicted by the model.

Such heterogeneity will cause an underestimate in population size as described above. This adverse effect can be reduced if we consider the animals seen every year as a special group and fit the model without the data for these animals so that it will not affect the model fit to the rest of the data. The resulting estimates can then be added to the difference between the observed number seen every year and the number seen every year as predicted by the model to obtain revised population estimates. We should see an improved model fit, increased estimates, and the residual plot should lose at least some of its 'U' shape. When this was done with the Gulf of Maine humpback data, the model fit did improve, the estimates did increase, and the 'U' shape in the residual plot was much reduced. These results are discussed in more detail below. The revised estimates are clearly an improvement, but could they be improved further by excluding from the model fit data for animals seen seven out of eight years as well?

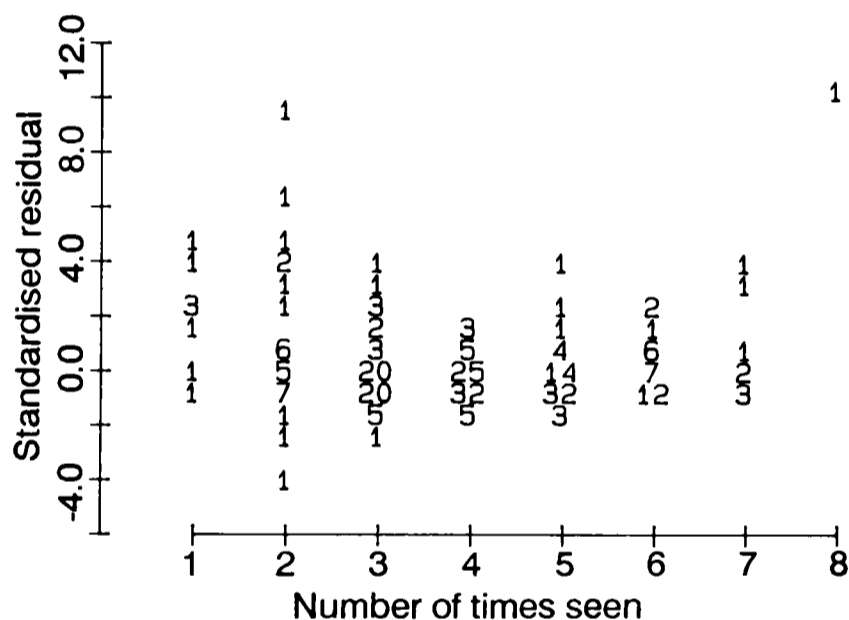

Fig. 2. As Fig. 1 for Gulf of Maine humpback whales, 1979-86.

Before we address that question, we must consider the justification for removing data for the purposes of fitting the model. Animals seen every year may be considered a special case, for example, because they inhabit an area which always receives high sampling effort or perhaps because they persistently exhibit some convenient behavioural characteristic and are therefore always captured. Claiming that animals seen on all but one occasion should also be included in this special group requires further justification. If we assume that this group does not have a capture probability of one but something a little less than one then most but not all individuals will be seen at each sample. The capture histories of our special group will therefore be distributed with many being seen every time, a smaller proportion seen all but one time, an even smaller proportion seen all but twice, etc. Removing data for capture histories with animals seen all but one year can then be justified on the grounds that any animals with these capture histories are part of the special group. This logic could be further extended to exclude animals seen all but twice, etc, but this leads to a progressively higher chance that 'ordinary' animals will be excluded.

To demonstrate this, consider a closed population of 500 animals. Of these, 50 have a probability of capture of 0.9 (the 'special' group), and the remaining 450 have a capture

Table 1

Number of animals in each of two groups which we would expect to see once, twice, etc., by the end of the study.

Number of animals	Capture probability	Number of times seen								Total
		1	2	3	4	5	6	7	8	
50	0.9	0	0	0	0	2	7	19	22	50
450	0.25	120	140	93	39	10	2	0	0	404

probability of 0.25. In an eight sample experiment with the standard assumptions for a closed population model being met, Table 1 gives the number of animals in each of these two groups which we would expect to see once, twice, etc., at the end of the study.

Table 1 shows that, in this case, removal of capture histories for animals seen 8, 7 and perhaps even 6 times would be acceptable in trying to reduce the effects of heterogeneity. In practice, of course, we do not know the number of groups, their size or average capture probabilities, or even if there are groups at all rather than a gradual cline in capture probabilities over the whole population. How, then, do we decide when to stop omitting data from the model fit? The change in the shape of the residual plot and the increase in the estimates of population size could be used as qualitative measures; that is, when the 'U' shape disappears from the residual plot and/or the estimates stop increasing it is time to stop excluding data.

Qualitative measures, however, are by their nature difficult to use as objective rules. A more useful measure is likely to be a quantitative one such as how well the model fits the data. Cormack's (1985) model measures fit as a deviance from the true model which theoretically approximates a chi-squared distribution. If one model is a special case of another more general one, the difference in deviance, with the appropriate difference in degrees of freedom, can be used to test if the more specialised model is significantly better than the general one. As Cormack (1985) described, there are problems with using tests which assume the chi-squared distribution on data sets with large numbers of zero cells; capture-recapture data are often like this, especially if average probability of capture is low or there are many sampling occasions. However, there is consensus that the approximation to a chi-squared distribution for the difference in deviance between two models, as above, will be much better satisfied than that for the deviance of a single model (Cormack, 1985). So, we could use whether or not there is a significant improvement in model fit as a rule for when to stop removing data from the fitting procedure.

Table 2 shows the result of successively removing capture histories for animals seen 8, 7, 6 and 5 times on the fit of the Jolly-Seber model to the Gulf of Maine humpback data. Estimates of population size increased successively, except in a few cases. The difference in deviance between models was highly significant as animals seen in 8 years, 8 and 7 years, and 8, 7 and 6 years were successively omitted from the model fit, but there was no significant difference when animals seen 8, 7, 6 and 5 years were excluded. Fig. 3 shows the residual plots from the four applications of the model. Clearly, it would be difficult to decide when to stop omitting data based only on the population estimates and residual plots, but the measure of model fit gives us an objective stopping rule.

Table 2

Jolly-Seber population estimates for Gulf of Maine humpback whales. Model fit is given as deviance (as calculated by Cormack, 1985) which approximates to a Chi-squared distribution. Whether or not a given model is significantly better than the immediately preceding one is measured by the difference in deviance between models. (i) = All data; (ii) = Capture histories for animals seen in 8 years excluded from model fit; (iii) = Capture histories for animals seen in 8 and 7 years excluded; (iv) = Capture histories for animals seen in 8, 7, and 6 years excluded; (v) = Capture histories for animals seen in 8, 7, 6, and 5 years excluded. * = Not significant at 5% level.

Model	Population estimates						Model		Difference between models		
	1980	1981	1982	1983	1984	1985	Dev.	df	Dev.	df	Signif.
(i)	171	172	213	241	280	335	347.2	235			
									55.4	1	P<0.001
(ii)	194	177	218	246	283	341	291.8	234			
									36.6	8	P<0.001
(iii)	180	184	224	251	286	349	255.2	226			
									65.1	28	P<0.001
(iv)	171	182	249	265	289	345	190.1	198			
									61.1	56	NS at 5% lev.*
(v)	165	232	276	287	305	372	129.0	143			

DISCUSSION

The method outlined above is a useful tool for the biologist who wishes to do more than merely apply a standard model with scant regard for the validity of its assumptions. It allows investigation of the crucial model assumption that capture probabilities are equal for all animals at each

sampling occasion. Furthermore, it allows the dexterous biologist to arrive at a set of population estimates which he/she believes are the best available.

What it does not do is provide an estimate of the variance of these estimates. Cormack (1985) deliberately avoided including the calculation of estimates of variance in his program because he considered the value of such estimates questionable. Another problem is that when we exclude data from the model fit we are treating the observed number of animals with these capture histories as an absolute count with no variability instead of their being estimated by the model with associated variance. As more data are excluded from the model fit, the variance, should it be calculated, would be more and more underestimated. I have avoided this problem by ignoring it, but if estimates of population size calculated by excluding data from the model fit are to be considered as best estimates, it needs to be addressed.

One further point of interest arises from the pattern of population estimates for Gulf of Maine humpbacks presented in Table 2. Regardless of which model is chosen, there is an upward trend with time equivalent to an annual rate of increase of about 14%. Three possible explanations for this increase are: (i) the population size in the area has increased; (ii) natural markings have changed with time resulting in 'marks' being lost; (iii) sampling effort and efficiency increased in such a way that each year previously unavailable animals were sampled. Population size may well have increased but is unlikely to have done so at a rate of 14% per annum unless immigration were also involved. Natural markings on humpback flukes have been shown to change with time (Carlson, Mayo and Whitehead, 1990)

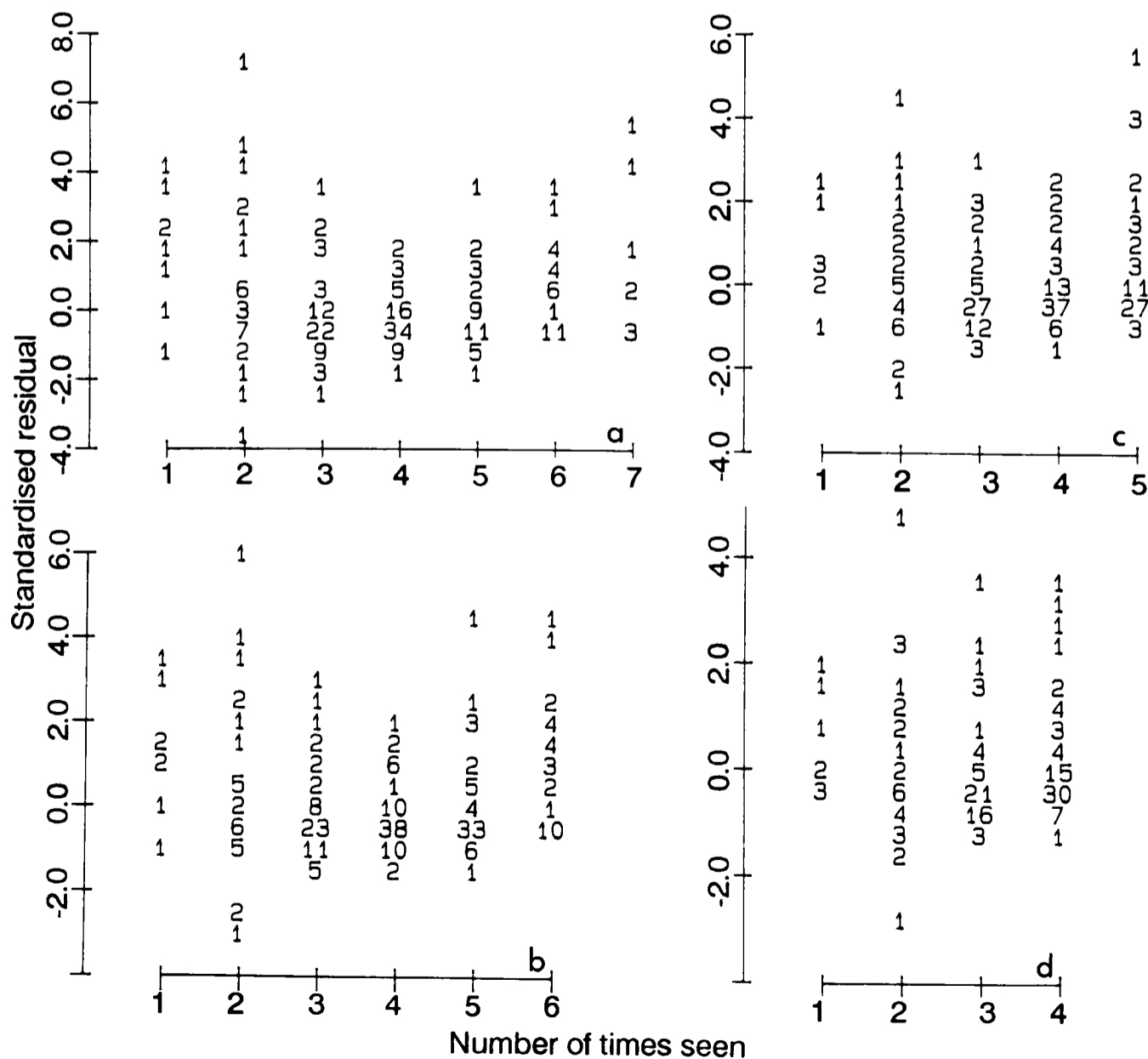

Fig. 3. As Fig. 2. (a) animals seen in 8 years excluded from the model fit, (b) animals seen in 8 and 7 years excluded, (c) animals seen in 8, 7 and 6 years excluded, (d) animals seen in 8, 7, 6 and 5 years excluded.

but not in a way which could account for such an increase. In addition, independent Petersen estimates of population size calculated from pairs of years show the same trend (Katona and Beard, 1990) which could not be a result of mark loss.

The third explanation seems most plausible. Humpback whales in the Gulf of Maine are known to prefer certain areas and sampling effort certainly increased from 1979 to 1986 covering a progressively wider area (P.J. Clapham, pers. comm.). Additional evidence comes from an examination of the survival rate and birth estimates from the Jolly-Seber model. Buckland (1989) has estimated survival rates to range between 0.92 and 0.97 per annum with no trend. Estimates of births, however, were 0, 25, 78, 43, 41 and 88 for 1980–1985 from model (iv) in Table 1, and were similar for all models. Clearly, it is new animals included in the population estimates rather than increased survival which has caused the increase apparent in Table 1. It is unlikely that all these 'births' were calves; they are more likely to be new animals sampled for the first time as the area sampled expanded. If this is indeed what has happened, it can be viewed as a progressive reduction of heterogeneity in the data as more and more animals became available to be sampled.

ACKNOWLEDGEMENTS

I am grateful to Steve Katona and Judy Beard at the College of the Atlantic for making the humpback data available to me. I also thank the Center for Coastal Studies, Provincetown, Mass.; Cetacean Research Unit, Gloucester, Mass.; Atlantic Center for Cetacean Research, Gloucester, Mass.; New England Aquarium, Boston, Mass.; New England Whale Watch, Newburyport, Mass.; Arundel Cruises, Kennebunkport, Maine; Maine Whale Watch, Northeast Harbor, Maine and Brier Island Ocean Study, Westport, Nova Scotia for their important contributions to the Gulf of Maine data collection and the Mingan Islands Cetacean Study, Sept Illes, Quebec for collecting most of the data in the Gulf of St Lawrence. I am also grateful to Greg Donovan for fruitful discussion of material presented in this paper, and to two anonymous referees for their comments.

REFERENCES

- Begon, M. 1979. *Investigating Animal Abundance – capture-recapture for biologists*. Edward Arnold, London. 97pp.
- Best, P.B. and Underhill, L.G. 1990. Estimating population size in southern right whales (*Eubalaena australis*) using naturally marked animals. Paper SC/A88/ID16 (published in this volume).
- Buckland, S.T. 1990. Estimation of survival rates from sightings of individually identifiable whales. Paper SC/A88/ID5 (published in this volume).
- Carlson, C.A., Mayo, C.A. and Whitehead, H. 1989. Changes in the ventral fluke patterns of individually identified humpback whales (*Megaptera novaeangliae*) and its effects on matching: evaluation of its significance to photo-identification research. Paper SC/A88/ID35 (published in this volume).
- Carothers, A.D. 1973a. Capture-recapture methods applied to a population with known parameters. *J. Anim. Ecol.* 42:125–46.
- Carothers, A.D. 1973b. The effects of unequal catchability on Jolly-Seber estimates. *Biometrics* 29:79–100.
- Cormack, R.M. 1985. Examples of the use of GLIM to analyse capture-recapture studies. pp. 243–73. In: B.J.T. Morgan and P.M. North (eds) *Statistics in Ornithology, Lecture Notes in Statistics 29* Springer-Verlag, Berlin.
- Gilbert, R.O. 1973. Approximations in the bias in the Jolly-Seber capture-recapture model. *Biometrics* 29:501–26.
- Hammond, P.S. 1986. Estimating the size of naturally marked whale populations using capture-recapture techniques. *Rep. int. Whal. Commn* (special issue 8):253–82.
- Katona, S.K. and Beard, J.A. 1990. Population size, migrations, and substock structure of the humpback whale (*Megaptera novaeangliae*) in the western North Atlantic Ocean. Paper SC/A88/ID3 (published in this volume).
- McCullagh, P. and Nelder, J.A. 1983. *Generalised Linear Models*. Chapman and Hall, London.
- Otis, D.L., Burnham, K.P., White, G.C. and Anderson, D.R. 1978. Statistical inference from capture data on closed animal populations. *Wildl. Monogr.* 62:1–135.
- Perkins, J.S., Balcomb, K.C., Nichols, G., Hall, A.T., Smultea, M. and Thumser, N. 1985. Status of the West Greenland humpback whale feeding aggregation, 1981–1983. *Rep. int. Whal. Commn* 35:379–83.
- Pollock, K.H. 1975. A K-sample tag-recapture model allowing for unequal survival and catchability. *Biometrika* 62:577–83.
- Pollock, K.H. 1981. Capture-recapture models allowing for age-dependent survival and capture rates. *Biometrics* 37:521–9.
- Roff, D.A. 1973. An examination of some statistical tests used in the analysis of mark-recapture data. *Oecologia* 12:35–54.
- Seber, G.A.F. 1982. *The Estimation of Animal Abundance and Related Parameters*. 2nd Edn. Griffin, London. 654pp.
- Stokes, S.L. 1984. The Jolly-Seber method applied to age stratified population. *J. Wildl. Manage.* 48:1053–9.

A Note on Problems in Estimating the Number of Blue Whales in the Gulf of St Lawrence from Photo-Identification Data

Philip Hammond

*Sea Mammal Research Unit, c/o British Antarctic Survey, High Cross,
Madingley Road, Cambridge, CB3 0ET, UK*

Richard Sears and Martine Bérubé

Mingan Island Cetacean Study, 285 Green Street, St Lambert, Quebec, Canada J4P 1T3

ABSTRACT

Capture-recapture techniques were applied to blue whale photo-identification data from the Gulf of St Lawrence, Canada to investigate whether the number of whales in the area could be estimated. The results were not consistent from year to year. This was judged to be a result of not being able to sample, in its entirety, a nomadic population in a large area. This has the same effect as if animals are temporarily absent and therefore unavailable to be sampled in one or more years. The highest estimate obtained was smaller than the total number of identified individuals.

INTRODUCTION

Sears, Williamson, Wenzel, Bérubé, Gendron and Jones (1990) have summarised photo-identification studies of blue whales carried out in the Gulf of St Lawrence since 1979. Blue whales are present in the Gulf from early April until December, with a peak in abundance from August to October. They are found regularly along the north shore, where they range widely during the feeding season, rarely spending more than about ten days in any particular area. Recently, blue whales identified in the Gulf of St Lawrence have been resighted in the Gulf of Maine (Wenzel, Mattila and Clapham, 1988) and off West Greenland (Larsen, pers. comm.) demonstrating that whales seen in the Gulf of St Lawrence are not limited to feeding only in that area.

There are now sufficient data from the Gulf of St Lawrence to allow exploratory analyses using capture-recapture methods to try to estimate the number of whales occurring in the area. This is the first time that such an exercise has been attempted for blue whales. Some of the general problems likely to be encountered in applying these techniques to natural markings data are discussed in Hammond (1986).

capture histories. Further restricting the data to minimise this problem has to be balanced with the loss of information which such a restriction imposes.

Of the 202 individuals identified in the period 1980/81-88, 71 (35%) were seen in more than one year (Table 1). Only 52 of the 255 possible capture histories were represented.

Table 1

Summary of blue whale photo-identification data from the Gulf of St Lawrence, 1980/81 - 1988.

Year	Number of whales seen	Number (%) newly identified that year	No. seen only in that year
1980/81	34	34 (100%)	15
1982	21	15 (71%)	5
1983	37	20 (54%)	11
1984	52	35 (67%)	20
1985	88	58 (66%)	49
1986	20	4 (20%)	2
1987	34	13 (39%)	7
1988	51	22 (42%)	22
Total	202		

DATA AND ANALYSIS

Data

Sears *et al.* (1990) have described the collection, cataloguing and matching of the photographic data and summarised the results. The data from 1980/81 to 1988 were used in our analyses. The years 1980 and 1981 were combined both because of the small sample sizes and to limit the number of sampling occasions to eight. Cormack (1985) recommends limiting the number of sampling occasions in order to avoid a large number of unrepresented capture histories in sparse data sets. When this occurs, observed data are a poor approximation to theoretical distributions assumed by the models and goodness-of-fit tests are not useful. The Gulf of St Lawrence data are sparse and even with eight sampling occasions there is a high proportion of unrepresented

Capture-recapture analyses

For the analyses, the data were arranged into a set of capture histories describing whether or not each whale was seen in each year. For a study with x sampling occasions there are $2^x - 1$ possible capture histories. This set of capture histories form the basic data for analysis. We do not, of course, know how many whales were present but never seen; estimating this number is the object of the exercise.

There are several convenient computer programs available to analyse capture-recapture data; this removes need to examine the details of model formulation (e.g. see IWC, 1990). We have chosen to use the log-linear model described by Cormack (1985) within the intended framework of the GLIM statistical package (McCullagh and Nelder, 1983). Cormack's model is ideal for primarily investigative analyses such as ours. Its features include: (i) selection of a variety of models including the standard Jolly-Seber open population model; and (ii) the ability to

investigate the presence of heterogeneity of capture probabilities through examination of residuals and possibly to account for this by assigning zero weight to sets of observations in the fitting of the model (see Hammond, 1990, for a detailed example of this for Gulf of Maine humpback whales).

A priori, we would expect an open population model to be the most appropriate for the data under investigation here because the study period covers several years, and births and deaths must be assumed to be occurring.

RESULTS AND DISCUSSION

When the standard Jolly-Seber open population model was fitted to the data, births were predicted to be negative between 1982 and 1983 and between 1985 and 1986. When the model parameters were constrained so as not to allow this, the results in Table 2 were obtained. The results are not consistent from year to year: the estimated number of animals ranges from 75 to 193 (even 193 is lower than the total number of identified whales); estimates of survival rate range from 0.45 to 0.93; and estimates of the number of births range from 0 to 75. It is highly improbable that these biological parameters are actually changing in this way.

Table 2

Results from fitting the Jolly-Seber model to blue whale data from the Gulf of St Lawrence. Births between years 1982 and 1983 and the years 1985 and 1986 were constrained to zero. N=estimated number of animals; S=estimated proportion surviving to that year; B=estimated number of births into that year

Year	N	S	B
1982	88	0.75	0
1983	75	0.86	0
1984	126	0.76	69
1985	193	0.93	75
1986	86	0.45	0
1987	87	0.83	18

A common problem in capture-recapture studies is that of unequal capture probabilities due to inherent differences among individual animals – ‘heterogeneity’. This may be a problem with the Gulf of St Lawrence data. In his analysis of humpback whale photo-identification data from the Gulf of Maine, Hammond (1990) appeared to successfully account for heterogeneity by treating animals seen every (or almost every) year in the data set as a separate ‘population’. This approach was unsuccessful when attempted with the Gulf of St Lawrence blue whale data and the inconsistency in the results remained.

It is more likely that the problems in obtaining consistent estimates are a result of temporary emigration. The relationship between whales which feed in the Gulf of St Lawrence and those seen elsewhere is unclear. About one-third of the individuals so far identified consistently return to the Gulf but there are others which have been seen in other feeding areas (see above). Within the Gulf, blue whales seem to move around considerably, groups of animals spending time in one area before leaving for another, presumably following or in search of prey. When combined with restrictions on the distribution of sampling effort in the large study area, this could readily result in not all animals being equally available for sampling on each occasion. The effect is variation in capture probabilities which cannot be modelled without additional independent information.

Examination of the data and results corroborates this theory. A comparison of Tables 1 and 2 reveals a high correlation between the number of whales identified and the population estimate in each year ($r^2=0.94$). This strongly suggests that not all animals are available to be sampled each year. Furthermore, a high proportion of the animals seen in 1984 and 1985, years when sampling effort was extended along the entire North Shore for the first time, had not been seen before. This translated into a high number of ‘births’ in those two years. Conversely, in 1986, a year when few whales were seen, only 20% of the whales had not been seen before; this translated into ‘births’ having to be constrained to zero and a ‘survival’ of only 0.45 from 1985 to 1986. Sampling from 1984 to 1988 was more extensive and more consistent than in earlier years (Sears *et al.*, 1990). However, when analyses were restricted to data from these years only, only a marginal improvement in the consistency of the results was achieved.

In summary, the inconsistent results can be explained as being caused by a combination of the distribution of the animals themselves and sampling effort within the study area. The variability in the estimates from year to year is a result of an inability to sample representatively from year to year. The question then becomes – what is a representative sample? As photo-identification of blue whales increases in areas outside the Gulf of St Lawrence, it may become apparent that the whales which visit the Gulf are a variable component of a larger population in the northwest Atlantic. In this proves to be true, it may never be possible to obtain a representative sample from the Gulf of St Lawrence alone. In this case, to obtain a valid estimate of the number of blue whales in the northwest Atlantic, the long-term goal must be to identify other feeding areas and to sample blue whales photographically throughout the northwest Atlantic.

ACKNOWLEDGEMENT

We would like to thank Greg Donovan for fruitful discussion of the material presented in this paper and for his comments on the manuscript.

REFERENCES

- Buckland, S.T. 1990. Estimation of survival rates from sightings of individually identifiable whales. Paper SC/A88/ID5 (published in this volume).
- Cormack, R.M. 1985. Examples of the use of GLIM to analyse capture-recapture studies. In: *Statistics in Ornithology* B.J.T. Morgan and P.M. North (eds.) *Lecture Notes in Statistics* 29:243–73. Springer-Verlag, Berlin.
- Hammond, P.S. 1986. Estimating the size of naturally marked whale populations using capture-recapture techniques. *Rep. int. Whal. Commn* (special issue 8):253–82.
- Hammond, P.S. 1990. Heterogeneity in the Gulf of Maine? Estimating humpback whale population size when capture probabilities are not equal. Paper SC/A88/ID4 (published in this volume).
- International Whaling Commission. 1990. Report of the Workshop on Individual Recognition and Cetacean Population Parameters (published in this volume).
- McCullagh, P. and Nelder, J.A. 1983. *Generalized Linear Models*. Chapman and Hall, London.
- Sears, R., Williamson, J.M., Wenzel, F.W., Bérubé, M., Gendron, D. and Jones, P. Photographic identification of the blue whale (*Balaenoptera musculus*) in the Gulf of St Lawrence, Canada. Paper SC/A88/ID23 (published in this volume).
- Wenzel, F., Mattila, D.K. and Clapham, P.J. 1988. *Balaenoptera musculus* in the Gulf of Maine. *Mar. Mammal Sci.* 4:172–5.

A Note on the Problem of False Positives in the Use of Natural Marking Data for Abundance Estimation

Thorvaldur Gunnlaugsson and Jóhann Sigurjónsson

*Marine Research Institute, Programme for Whale Research, P.O. Box 1390,
Skúlagata 4, 121 Reykjavík, Iceland*

ABSTRACT

Examinations of possible bias in population estimates obtained from mark-recapture analyses have tended to ignore or underestimate the problem of false positives i.e. where two separate photographs of two different individuals are erroneously matched. This paper examines this question and concludes that false positives are a potentially serious problem for population estimation, particularly for large populations of less easily identifiable species.

INTRODUCTION

The recognition of individual whales from photographs of natural markings has been used in studies of several species of whales in recent years (see summary in IWC, 1990).

For estimating abundance, the method works well when the markings are relatively easy to distinguish and the population is small (in the hundreds), such as in the Vancouver Island/State of Washington killer whales (Olesiuk and Bigg, 1990; Bigg, Olesiuk, Ellis, Ford and Balcomb, 1990), where the entire population has been photographically documented. In the southern right whale populations, where a major proportion of the stocks are photo-identified, the method has also been applied with success (Whitehead, Payne and Payne, 1986; Payne, Rowntree, Perkins, Cooke and Lankester, 1990; Best and Underhill, 1990). The largest population of whales where extensive mark-recapture schemes of photo-identified animals have been conducted is that of humpback whales in the North Atlantic (Katona and Beard, 1990). Hammond (1986) reviewed and analysed the theoretical and practical aspects of applying capture-recapture techniques for estimating the size of naturally marked whale populations. He explored several potential problems in the use of natural markings, some of which also occur with traditional (Discovery-type) whale marking (see Buckland and Duff, 1989). Problems encountered using traditional marking techniques include misfirings, marking mortality, mark loss and incomplete mark returns. With natural marking techniques, some of these problems are absent and others are more likely to be quantifiable because of the possibility of repeated recaptures. The above problems all cause too few marks to be returned. In this paper this is termed the recapture of false negatives i.e. positives are missing from the sample.

Another major problem in both traditional and natural marking is the heterogeneity in markability of the animals (Hammond, 1986; 1990). This arises out of accessibility to the area in question, whether the animals are easily detectable and/or easy to approach for marking (photographing). In particular with natural markings, an additional source of error is in the judgement of the photographs, which is needed before the whale can be considered marked.

There is, however, a further type of error exclusive to natural marking techniques. This occurs when too many marks are returned, i.e. when two separate photographs of

two different individuals are erroneously matched. These errors will be termed here false positives. Such errors are also possible with DNA fingerprinting, although the probability may prove extremely small, at least in species like the fin whale, where in theory the error rate should not exceed one in a million (Amos and Hoelzel, 1990; Spilliaert, Pálsdóttir and Arnason, 1989).

Although the problem of false positives has been briefly mentioned in the photo-identification literature (e.g. Payne, Brazier, Dorsey, Perkins, Rowntree and Titus, 1983; 1990; Hammond, 1986; Carlson, Mayo and Whitehead, 1990; Perry, Baker and Herman, 1990), it has not been analysed sufficiently nor has it even been identified as a problem of any major importance. The present paper considers how false positives can seriously affect estimates of population size based on natural marking data, and discusses the subsequent limitations of using the technique.

THE PROBLEM IN ABUNDANCE ESTIMATION

The false negative error is likely to grow linearly with the number of true matches in the sample. A similar number of matches is needed for a big and small stock to achieve a certain relative precision. With an efficient identification system that does not suffer from fatigue (this would increase the rate of errors due to failures to find matches as the sample becomes larger), a false negative error level of, say 1%, would result in a 1% bias in the population estimate, whatever the size.

In the case of false positives, however, an error can be made each time two photographs of different whales are compared. The number of comparisons needed grows with the square of the sample size, S , which is of fundamental importance in understanding the nature of the problem. If this false positive error rate, P , is assumed uniformly distributed, the result is an upper bound for the Petersen estimator of population size, N , which is equal to the inverse of the error rate:

$$N = S_1 S_2 / [M + P(S_1 - M)(S_2 - M)] < 1/p,$$

where M is the number of true matches between the samples S_1 and S_2 .

That is, if the false positive error rate is 1/1,000, the theoretical upper bound of the estimate will be 1,000 animals, whatever the size of the population. This does not mean that the estimate may not exceed 1,000 in practice, since there will always be individuals which are more distinguishable than others, so the assumption of a uniform distribution of errors is clearly not correct. Estimates of abundance from individual years have in some cases been found to be consistently lower than the accumulated number of identified animals (e.g. Fairfield, 1990). Heterogeneity in mark-recapture has been suggested as the cause, but false positive errors with a non-uniform distribution are another possibility.

To take the other extreme in error distribution (i.e. a non-uniform distribution of errors), let us assume that 3.16% of the individuals of the population are all indistinguishable and will always result in error matchings, the rest being correctly matched. Comparing two photographs at random, the false positives would be 0.0316 squared or 1/1,000 as before. However, as all the like individuals would be considered a single individual and would only ever produce a single false match, the problem would decrease with increasing sample size. In this extreme case the error is very sensitive to the way the data are handled. Comparing many small samples and combining the results causes a greater problem. In this case these errors, as well as the bias introduced by heterogeneity in markability (see e.g. Hammond, 1986; 1990), can be reduced by e.g. eliminating individuals which are repeatedly matched.

Presumably, there are human errors in sampling and data handling which are uniformly distributed but the true matching errors depend on the pattern variability. The inheritance of colour patterns in mammals is in many cases well understood (Adalsteinsson, 1970; Adalsteinsson, Sigurjónsson and Jónsson, 1979). Also the development of the patterns can be explained by relatively simple diffusion models (Murray, 1988). The principal patterns appear to be under the control of genes at a few loci with a few alleles. The patterns can thus be widely different, but intermediate forms or combinations are not expected. The bulk of the population is likely to be centred around the phenotypes of the most common allele combinations. The probability of error also depends on how many photographs of the animal are available, the quality of the photographs and in general, conditions during photographing. In the case of fin whales, Agler *et al.* (1990) conclude that several photographs may be needed for safe identification.

The real world probably lies somewhere in between the two extreme cases of uniform error probability and all the errors due to an indistinguishable group of individuals. For a simplified demonstration of a case between the extremes, let us assume that within each of the 100 most common phenotypes, 0.316% of the population is lumped and indistinguishable. This constitutes 31.6% combined. Assume the remaining 68% are never wrongly matched. The false positive error rate is then 0.00316 squared times 100 or as before 1/1,000, but in this case sample sizes in the hundreds are needed before the numbers of multiple recaptures of like individuals become detectably out of proportion. Furthermore, such deviations would most likely be masked by larger deviations due to heterogeneity in mark-recapture. The number of identifiable individuals can, however, grow to 68% of the population size, whatever its size.

DISCUSSION AND CONCLUSIONS

It should be noticed that the problem of false positives discussed above is different from the existence of identical twins in a population (see Payne *et al.*, 1983). If the frequency of identical twins is 1%, the population estimate will be downward biased, but only by 1% as 1% of the individuals would not be distinguished from their identical twins. This error is independent of population or sample size. Payne *et al.* (1983) attempted to calculate the total number of different possible combinations of the features used for photo-identification of right whales. Such an approach is, however, not useful in addressing the problem of false positives, because no matter how many distinguishable individuals might exist or actually do exist, there can be lumps of individuals which are hard to distinguish, and photographs (or series of photographs) which appear good but are in fact insufficient.

Payne *et al.*'s (1983) second approach was to estimate the likelihood of detecting indistinguishable individuals from other marks or auxiliary information. This is directly relevant to the present problem, but the question is what happens when the matcher finds photographs of very similar individuals, which he knows cannot be the same. He may reject one of the photographs as too poor or he may choose to include in the catalogue other photographs which might be available and show better some distinguishable features. There will then be no clue to the problem in the catalogue, simply because the matcher is trying to do a good job. The matcher might also include both photographs in the catalogue and distinguish the individuals by some finer details than would ordinarily be taken into account. In that case, this piece of information on the problem is in the catalogue and could be tested by independent matchers. In all other cases, only the best photograph of what could be a group of similar whales is included in the catalogue. Matching errors can therefore not be tested within existing catalogues, but only by comparison between catalogues from isolated areas. If the distribution of phenotypes in both areas is similar, the lumps of phenotypes would still be under-represented in the catalogues. When the distribution of phenotypes is dissimilar in the catalogues (areas), the error will also be underestimated because the lumps will not coincide.

As noted above, only the problem of false negatives (failure to match) has been seriously addressed by earlier authors, and then as a potential source of upward bias in the resulting population estimate. The false positive error has on the other hand, mostly been ignored or commented to be minor, as matchers have tried to be cautious in using poor photographs and making only clear matches. The importance of this error has remained unaddressed. A part of the reason may be that the early photo-identification work was carried out on small populations of whales, where this kind of error can be ignored.

Carlson *et al.* (1990) made an interesting examination of the possible error rate in matching of humpback whale fluke photos, with special reference to the possible effects of disappearance of markings with age and the experience of the person conducting the matching work. Both factors seemed to affect the results, but most striking was the actual false positive error rate of 0.005 for experienced matchers. This error rate of 1/200 is astonishingly high. Their test consisted of pairs of single photographs, but frequently there may be alternative photographs available to the matcher. It may also be easier to judge photographs by comparing each to a well organized catalogue than just

in isolation as was done in the test. Other factors need to be looked into before any firm conclusions about the actual error rates can be made. The upper limit for North Atlantic humpback whales from photo-identification work is 8,122 ($5,505 \pm 2,617$, Katona and Beard, 1990), which contradicts the high rate given by Carlson *et al.* (1990). It seems evident, however, that when considering large stocks or stocks exceeding several thousand animals, when an error rate of one in a few thousands is not unrealistic, that the false positive errors can easily become critical in judgement of the size of the stock. If one only considers, for example, the human errors in handling and labelling of samples (or photographs) during field work or while processing in the laboratory, we are faced with at least some small rate of errors that may be at the level of one out of a number which does not exceed the number of individuals in the largest stocks. In this regard 'contamination' of samples has been mentioned as a problem that needs to be specifically addressed in genetic research (IWC, in press; Kitchin, Szotyori, Fromholz and Almond, 1990); it may be similarly relevant here.

The problem of false positives in whale marking has been greatly understated within the scientific community. False positive errors have the potential to cause biases in some of the current work on stock estimation, even though this has mostly been limited to small populations and species with good patterns for recognition. It is important that analyses and tests be performed in order to quantify the potential errors.

Joyce and Dorsey (1990) examined the feasibility of using the photo-identification technique for minke whales in the Southern Hemisphere and concluded that although minke whales can be identified, obtaining precise estimates of population size is probably not feasible with the present capture efficiency and available resources. For estimating survival rates from natural markings in Antarctic minke whales, Buckland (1990) concluded that a marking programme would have to continue for many years at a high level (perhaps of the order of 0.2 of the population each year or higher). It therefore seems unlikely that natural marking data can replace age data from catches in large stocks (although use of age data also has some problems). To these difficulties the potential problems of false positives discussed above must be added. In discussion of methods other than using data from catches for the study of whale populations, it is therefore important to consider the possible waste of effort and resources for stock estimation of the poorly identifiable and often numerous species, like fin and minke whales.

ACKNOWLEDGEMENT

Our sincere thanks to G.P. Donovan and P.S. Hammond for their critical comments on the manuscript and for useful suggestions for the final draft.

REFERENCES

- Adalsteinsson, S. 1970. Colour inheritance in Icelandic sheep and relation between colour, fertility and fertilization. *J. Agric. Res. Icel.* 2: 3-135.
- Adalsteinsson, S., Sigurjónsson, Th. and Jónsson, G. 1979. Variation in colour gene frequencies among Icelandic cats. *Carnivore Genetics Newsletter* 3(10): 359-72.
- Agler, B.A., Beard, J.A., Bowman, R.S., Corbett, H.D., Frohock, S.E., Hewvermale, M.P., Katona, S.K., Sadove, S.S. and Seipt, I.E. 1990. Finback whale, *Balaenoptera physalus*, photographic identification: methodology and preliminary results from the western North Atlantic. Paper SC/A88/ID20 (published in this volume).
- Amos, B. and Hoelzel, R.A. 1990. DNA fingerprinting cetacean biopsy samples for individual identification. Paper SC/A88/ID29 (published in this volume).
- Best, P.B. and Underhill, L.G. 1990. Estimating population size in southern right whales *Eubalaena australis* using naturally marked animals. Paper SC/A88/ID16 (published in this volume).
- Bigg, M.A., Olesiuk, P.F., Ellis, G.M., Ford, J.K.B. and Balcomb, K.C. 1990. Social organisation and genealogy of resident killer whales (*Orcinus orca*) in coastal waters off British Columbia and Washington State. Paper SC/A88/ID39 (published in this volume).
- Buckland, S.T. 1990. Estimation of survival rates from sightings of individually identifiable whales. Paper SC/A88/ID5 (published in this volume).
- Buckland, S.T. and Duff, E.I. 1989. Analysis of the Southern Hemisphere minke whale mark-recovery data. *Rep. int. Whal. Commn* (special issue 11): 121-43.
- Carlson, C.A., Mayo, C.A. and Whitehead, H. 1990. Changes in the ventral fluke pattern of the humpback whale, *Megaptera novaeangliae*, and its affect on matching: evaluation of its significance to photo-identification research. Paper SC/A88/ID45 (published in this volume).
- Fairfield, C.P. 1990. Right whale abundance estimation, with emphasis on *Eubalaena glacialis* in the western North Pacific. Paper SC/A88/ID45 (published in this volume).
- Hammond, P.S. 1986. Estimating the size of naturally marked whale populations using capture-recapture techniques. *Rep. int. Whal. Commn* (special issue 8):253-82.
- Hammond, P.S. 1990. Heterogeneity in the Gulf of Maine? Estimating humpback whale population size when capture probabilities are not equal. Paper SC/A88/ID4 (published in this volume).
- International Whaling Commission. 1990. Report of the Workshop on Individual Recognition and the Estimation of Cetacean Population Parameters. (Published in this volume).
- International Whaling Commission. In press. Report of the Workshop on the Genetic Analysis of Cetacean Populations. *Rep. int. Whal. Commn* (special issue 13).
- Joyce, G.G. and Dorsey, E.M. 1990. A feasibility study on the use of photo-identification techniques for Southern Hemisphere minke whale stock assessment. Paper SC/A88/ID43 (published in this volume).
- Katona, S.K. and Beard, J.A. 1990. Population size, migrations and feeding aggregations of the humpback whale, *Megaptera novaeangliae*, in the western North Atlantic Ocean. Paper SC/A88/ID2 (published in this volume).
- Kitchin, P.A., Szotyori, Z., Fromholz, C. and Almond, N. 1990. Avoidance of false positives. *Nature* 344:201.
- Murray, J.D. 1988. How the leopard gets its spots. *Scientific American* 258(3):62.
- Olesiuk, P. and Bigg, M.A. 1990. Life history and population dynamics of resident killer whales (*Orcinus orca*) in coastal waters off British Columbia and Washington State. Paper SC/A88/ID3 (published in this volume).
- Payne, R., Brazier, O., Dorsey, E.M., Perkins, J.S., Rowntree, V. and Titus, A. 1983. External features in southern right whales (*Eubalaena australis*) and their use in identifying individuals. pp. 371-445. In: R. Payne (ed.) *Communication and Behavior of Whales* AAAS Selected Symposia Series 76. Westview Press, Boulder, Colorado. 643pp.
- Payne, R., Rowntree, V., Perkins, J.S., Cooke, J.G. and Lankester, K. 1990. Population size trends and reproductive parameters of right whales (*Eubalaena australis*) off Peninsula Valdes, Argentina. Paper SC/A88/ID1 (published in this volume).
- Perry, A., Baker, C.S. and Herman, L.M. 1990. Population characteristics of individually identified humpback whales in the central and eastern North Pacific: a summary and critique. Paper SC/A88/ID25 (published in this volume).
- Spilliaert, R., Pálsdóttir, 'A. and 'Arnason, A. 1989. DNA fingerprinting in two species of baleen whales: fin (*Balaenoptera physalus*) and sei whales (*B. borealis*) using a human hypervariable region probe, Globin 3'HVR. Paper SC/S89/Gen19 presented to the IWC Scientific Committee Genetic Workshop, September 1989, 10pp.
- Whitehead, H., Payne, R. and Payne, M. 1986. Population estimate for right whales off Peninsula Valdes, Argentina, 1971-1976. *Rep. int. Whal. Commn* (special issue 10): 169-71.



Population Parameters,
Dynamics and Behaviour

Estimation of Survival Rates from Sightings of Individually Identifiable Whales

S.T. Buckland

*Scottish Agricultural Statistics Service, Aberdeen Unit, Macaulay Land
Use Research Institute, Craigiebuckler, Aberdeen AB9 2QJ, Scotland*

ABSTRACT

Estimation of survival rates from repeated sightings of individually identifiable whales is considered, with particular reference to bias as a result of heterogeneity in the probabilities of sighting between animals. The natural markings data on Atlantic humpback whales are used to illustrate the approach, and the annual survival rate of the Gulf of Maine stock is estimated to be 0.951, with standard error 0.010 and 95% confidence interval (0.929, 0.969).

INTRODUCTION

The development of methods to individually identify live whales allows the use of statistical models that potentially estimate population sizes and survival rates more reliably than those that have been applied to dead recovery data from marking programmes. For a discussion of the models used and the problems that arise when marks are fired into animals, some of which are subsequently recovered by the whaling operation, see for example Buckland and Duff (1989). Hammond (1986) provides a useful review of the problems associated with natural markings data, and of how to estimate population size from them. We consider here only the specific problem of estimating survival rates, and one possible solution to it.

METHODOLOGY

The Jolly-Seber model (Jolly, 1965; Seber, 1965) allows estimation of the following parameters.

N_i = number of whales in the population just before sample i , $i=1, \dots, s$.

M_i = number of identified whales in the population just before sample i .

ϕ_i = probability that a whale survives from sample i to $i+1$.

B_i = number of whales recruited to the population between samples i and $i+1$.

p_i = probability that a given whale is identified during sample i .

The likelihood function for this model is rather complex, and may be found for example in Seber (1982, p.198). For the model to be valid, we assume:

- (1) Every living whale, whether identified previously or not, has the same probability p_i of being identified in the i^{th} sample.
- (2) Every whale has the same probability ϕ_i of surviving from sample i to sample $i+1$.
- (3) Whales are correctly identified.
- (4) Identified whales are independent of each other. For example, if one whale is identified in sample i , this should not affect the probability that any other is identified.
- (5) Sampling time is negligible.

For the natural markings data, possible violations of the first assumption have the greatest potential impact on survival estimation. The assumption implies that whales should not transfer from the stock or population being sampled to another, unless such transfers are random, and the probability that a whale is in the population at one sampling occasion is independent of whether it was present at the previous sampling occasion. Permanent emigration is allowed only if 'survival' means that the animal neither dies nor emigrates. Similarly, we can allow immigration if we do not wish to distinguish between births and immigration. Non-random temporary emigration is problematic, and may be regarded as a violation of assumption (1) above.

Hammond (1986) considers each assumption, and in particular, discusses problems associated with the first in detail. Here, we adopt the philosophy that natural markings data will inevitably violate the assumption of equal probability of sighting for all whales, and develop a method by which survival estimates most subject to bias are deleted. We use 'sighting' here to mean that a whale is seen and individually identified (for example from a photograph).

Carothers (1979) developed a method for quantifying the effect of heterogeneous probabilities of sighting, and hence, estimating survival. Buckland (1982) analysed the same data, but chose to delete estimates most affected by bias. This led to higher estimated survival rates, suggesting that the method of Carothers may not be completely successful in removing bias. We therefore adopt the latter approach, which was developed for analysis of ornithological data sets.

The sightings data may be divided into 'cohorts', where cohort j is defined to be all whales first identified in year j . We then utilise all subsequent resightings of whales belonging to that cohort. Ideally, a cohort should consist of whales all of the same age, so that age-specific survival rates may be estimated. In practice, cohorts consist of a mixture of unknown age animals. This does not rule out the ability to assess whether animals at older ages exhibit higher or lower survival rates, because every animal in a cohort, as defined above, is known to age one year for every year that passes. However, the survival rate at a specific age cannot be estimated; instead, 'age-specific' estimates become estimates of survival at a given number of years after first identification.

Since there can be no new whales entering a cohort once it has been defined, we adopt a special case of the Jolly-Seber model for which there is no birth or immigration. The number of previously identified whales of the cohort seen in a given year will be equal to the total number of whales from that cohort seen in that year for every year except the first; applying the standard Jolly-Seber model to such data automatically yields the estimates for the model without recruitment. Seber (1982, pp.214-7) describes a similar circumstance, in which not all animals within a cohort are identified in the first sample. Hence, using his notation and adapting his equations (which were first derived by Cormack, 1964), we obtain: s = number of samples; M_1 = initial number of whales identified - this defines the cohort; $m_i = R_i$ = number of whales from the cohort seen during sample i , $i=2, \dots, s$; r_i = number of whales seen both during sample i and again subsequently; z_i = number of whales not seen in sample i but seen again subsequently;

$$\begin{aligned}\hat{M}_i &= m_i(1+z_i/r_i), \quad i=2, \dots, s-1; \\ \hat{\phi}_i &= \hat{M}_{i+1}/\hat{M}_i, \quad i=2, \dots, s-2, \quad \text{with } \hat{\phi}_1 = \hat{M}_2/M_1; \\ \hat{p}_i &= m_i/\hat{M}_i, \quad i=2, \dots, s-1, \quad \text{with } p_1 = 1.0.\end{aligned}$$

For sparse data, or when probability of survival is close to unity (as for whales), estimated probabilities of survival may exceed unity, or be infinite or undefined. We avoid these problems by using the modified Jolly-Seber model of Buckland (1980), for which estimators do not exist in closed form. Computer programs are available from the author.

Having analysed each cohort of whales separately, estimates may be combined across cohorts. We can do this in two ways; combining either by date or by years from first identification. Buckland (1982) showed that estimated survival of a given cohort from the year in which they were first identified to the first year of resightings may be seriously biased in the presence of heterogeneity in the probabilities of sighting, as may the final few estimates before recording ends. He demonstrated this by carrying out simulations with varying degrees of heterogeneity for which the true survival rate was constant, and noted that the pattern of apparent variation in survival estimates was similar to that observed in real data sets. If estimated survival for the first year of each cohort is discarded, and the remaining estimates combined by date, estimates towards the end of the sequence of survival estimates, corresponding to the last few years of recording, will be smaller than earlier estimates in the presence of heterogeneity. If we can assume that survival is constant over time, we can use this sequence (perhaps in the form of a plot of estimated log proportion surviving against date) to assess the number of estimates towards the end of the sequence that are seriously affected by bias. This number of estimates should then be deleted from the end of the sequence for each individual cohort. The remaining estimates may then be combined by years from first identification. More details of this approach are given by Buckland (1982).

Having combined estimates across cohorts, we may wish to obtain a single estimate of survival rate. If it is not reasonable to assume that survival rates are independent of age (at least from the age at which whales are first identified), a straight arithmetic or geometric mean of the estimates of survival might be used, although estimation may be poor if some of the individual estimates are based

on very small sample sizes, and it is unclear what the average survival would represent. Given sufficient data on known-age animals, the age-specific survival rates should be used in their own right, and not averaged. If a plot of log proportion surviving against years from first identification shows no indication that survival rates are dependent on age, we may take a weighted average of the survival estimates. I suggest using the arithmetic mean, with the weight for the survival estimate j years after first identification being equal to the estimated number of identified whales still alive after that length of time. Although this weighting is *ad hoc*, it reflects the likely reliability of estimates better than would sample size for example, since the estimate corresponding to a sample of small size will be relatively reliable if sample sizes are large either side of it, both because data from these larger samples affect the unmodified Jolly-Seber survival estimate and because the modified estimate further utilises information from other sample sizes. Further, it may be argued that 'average' survival should reflect age structure, which the above weights do, although imperfectly. Alternatively, weights could be set equal to the reciprocal of the variances of the modified estimates, generated using the bootstrap, as indicated below. If the survival rates were known, the geometric mean of survival rates would be a more appropriate measure of average survival than the arithmetic mean. However, when they are estimated, the choice is less clear, and Cormack (pers. comm.) prefers the arithmetic mean, which we adopt here. The two methods usually yield almost identical estimates in practice. 'Average' survival is not necessarily very meaningful if survival is strongly dependent on age. If 500 of 1,000 animals survive a single year, and none survive the second, average survival could be estimated as $(0.5+0.0)/2 = 0.25$, or as $(1,000 \times 0.5 + 500 \times 0.0)/1500 = 0.33$, or as $(0.5 \times 0.0)^{0.5} = 0.0$ (the geometric mean), or in several other ways. For the concept to be useful, we require that survival is independent of age, or is only weakly dependent on age, in which case alternative methods yield similar estimates.

Once the estimation procedure has been set up on a computer, it is simple to obtain bootstrap standard errors and confidence intervals for parameter estimates. Use of the parametric bootstrap in this context is described by Buckland (1980). We prefer the nonparametric bootstrap, in which sampling with replacement from the observed capture histories is carried out. This technique is described fully by Buckland and Garthwaite (in press.).

Other approaches can be developed. For example, the methods of Sandland and Kirkwood (1981) provide maximum likelihood estimation when either probability of survival or probability of identification or both are assumed constant. Their models are special cases of the reduced parameter models of Jolly (1982), for which births do not occur, as for the cohorts defined above. The models have been taken further by J. Clobert and J.D. Lebreton, for example to incorporate covariates that might correlate with survival rates (Clobert and Lebreton, 1985), and if heterogeneity in the probabilities of identification can be adequately addressed, this method promises to be superior to that presented here.

ANALYSES OF HUMPBACK WHALE DATA

Numerous photographs exist of North Atlantic humpback flukes, taken by many different people in various breeding and feeding grounds. Many result from opportunistic or 'casual' encounters with animals, while others arise out of

Table 1

Sample size (n_i), number previously identified (m_i), number seen during sample i and again later (r_i) and number not seen during sample i but seen both before and after (z_i) for Gulf of Maine humpback whales, 1978-83.

Year	n_i	m_i	r_i	z_i
76	37	0	28	0
77	20	6	19	22
78	26	8	23	33
79	62	24	60	32
80	125	60	110	32
81	119	93	106	49
82	150	108	132	47
83	160	118	140	61
84	224	166	175	35
85	268	186	140	24
86	243	164	0	0

Table 2

Sample size (n_i), number previously identified (m_i), number seen during sample i and again later (r_i) and number not seen during sample i but seen both before and after (z_i) for Newfoundland/Labrador humpback whales, 1978-83.

Year	n_i	m_i	r_i	z_i
78	268	0	63	0
79	484	40	82	23
80	260	61	38	44
81	52	14	6	68
82	208	34	28	40
83	264	68	0	0

organised research activities. S. Katona (College of the Atlantic, Bar Harbor, Maine, USA) has gathered a large number of these photographs together at one site, so that individual whales may be identified and monitored from the natural markings on their flukes. The resulting mark-recapture data from the Gulf of Maine (1976-86) and the Newfoundland/Labrador area (1978-83) are summarised in Tables 1 and 2 respectively. Corresponding estimates under the modified Jolly-Seber model are given in Tables 3 and 4. \hat{M} is the estimated number of whales in the relevant stock that have been identified before a given year and are still alive, \hat{N} is the estimated stock size in that year, \hat{B} is the estimated number of recruits between that year and the next, $\hat{\phi}$ is the estimated probability of survival between that year and the next, and \hat{p} is the estimated probability that a whale will be identified in that year. Table 3 shows plausible estimates of survival, although the first and last estimates are low. The geometric mean of the estimates is 0.919 with standard error 0.012. The corresponding 95% confidence interval for mean survival is (0.893, 0.939). However, estimated stock size shows an implausible rate of increase during 1977-85, correlating with an estimated increase in the probability of sighting. Table 4 shows stable estimation of stock size, but survival estimates are low; the geometric mean is only 0.679 (standard error 0.044) for these estimates, and the 95% confidence interval for the mean survival rate is (0.591, 0.760). It seems clear that the violation of at least one assumption is generating substantial bias in the estimates.

If we now apply the analysis of cohorts described above to the Gulf of Maine data, using all sightings during

Table 3

Modified Jolly-Seber estimates for the Gulf of Maine humpback data, 1976-86.

Year	\hat{M}	\hat{N}	\hat{B}	$\hat{\phi}$	\hat{p}
76				0.806 (0.080)	
77	30 (6)	99 (32)	43 (31)	1.000 (0.025)	0.201 (0.072)
78	44 (7)	142 (29)	16 (25)	0.929 (0.046)	0.182 (0.052)
79	57 (8)	148 (21)	50 (20)	1.000 (0.011)	0.418 (0.062)
80	95 (9)	199 (16)	6 (8)	0.923 (0.028)	0.629 (0.049)
81	148 (11)	189 (13)	49 (11)	0.928 (0.029)	0.628 (0.044)
82	161 (11)	224 (15)	48 (11)	0.923 (0.028)	0.669 (0.040)
83	188 (11)	255 (14)	51 (11)	0.918 (0.028)	0.629 (0.037)
84	211 (11)	284 (14)	89 (13)	0.863 (0.038)	0.788 (0.031)
85	232 (13)	334 (16)			0.802 (0.035)

Table 4

Modified Jolly-Seber estimates for the Newfoundland/Labrador humpback data, 1978-83.

Year	\hat{M}	\hat{N}	\hat{B}	$\hat{\phi}$	\hat{p}
78				0.656 (0.110)	
79	176 (31)	2127 (440)	303 (255)	0.589 (0.105)	0.228 (0.052)
80	365 (66)	1556 (320)	539 (523)	1.000 (0.130)	0.167 (0.032)
81	564 (85)	2096 (625)	873 (511)	0.550 (0.145)	0.025 (0.009)
82	331 (76)	2026 (571)			0.103 (0.027)

Table 5

Estimated number of surviving whales in each cohort for the Gulf of Maine humpback data. The first number in each sequence is the number of whales originally comprising the cohort.

Cohort	Year									
	76	77	78	79	80	81	82	83	84	85
1976	37	28.4	28.4	28.4	28.4	28.4	25.6	23.5	23.5	19.4
1977		14	13.4	13.4	13.4	12.8	11.3	11.3	10.3	9.0
1978			18	15.0	15.0	15.0	15.0	13.3	12.0	11.0
1979				38	36.7	34.6	31.2	30.0	30.0	30.0
1980					65	55.5	53.1	50.3	47.5	41.2
1981						26	22.5	21.2	21.2	21.2
1982							42	36.6	28.5	27.3
1983								42	33.3	26.1
1984									58	40.6

1976-86, and placing each identified whale into a cohort according to which year in this period it was first identified, the estimates of Table 5 are obtained. These estimates may be summed across cohorts, either by summing estimates corresponding to the same year (Table 6) or by summing estimates corresponding to the same number of years after first identification (Table 7). The estimates of survival for a given year in Table 6 are found by dividing the entry in column (2) for the following year by that in column (1) for the same year. For example, $\hat{\phi}_{80} = 90.8/93.5 = 0.971$. The final estimate of $\hat{\phi}$ in Table 6 is smaller than the rest, indicating that it may be biased downwards through heterogeneous probabilities of sighting. There is little evidence of bias in the remaining estimates. (Note that the estimates equal to unity are based on small numbers of identified whales). Hence, I have chosen here to delete a single estimate from the end of each cohort, to reduce the

Table 6

Estimates of Table 5 combined by date. Column sums from Table 5, excluding the initial number marked, are shown in column (1), while column (2) also excludes the first estimate for each cohort. The entry for year i in column (3) is the ratio of the column (2) entry for year $i+1$ to the column (1) entry for year i .

Year	Estimated number identified		$\hat{\phi}$ (3)
	(1)	(2)	
77	28.4		1.000
78	41.8	28.4	1.000
79	56.8	41.8	1.000
80	93.5	56.8	0.971
81	146.3	90.8	0.930
82	158.6	136.1	0.944
83	186.3	149.6	0.929
84	206.3	173.0	0.897
85		185.2	

effects of heterogeneity. The resulting estimates of survival, after combining by years after first identification, are given in column (3) of Table 7. Shown in column (4) of Table 7 are the 'unadjusted' estimates of survival; if the last estimate of each cohort is retained, and if in addition we estimate probability of survival between first identification and the following year, the estimates in the final column of Table 7 are obtained. The first estimate of this sequence, $\hat{\phi}_0 = 0.830$, is calculated as $(28.4+13.4+\dots+40.6)/(37+14+\dots+58) = 282.0/340$ (see Table 5), where 340 is the total number of whales identified in the Gulf of Maine during 1976-84. It is estimated from relatively large sample sizes, and yet is substantially lower than all the other estimates except the last. This is good evidence of the presence of heterogeneity in the probabilities of sighting, and suggests that we need to take account of the effect in these data.

In Table 8, we show estimates of mean annual survival for humpback whales in the Gulf of Maine. The arithmetic mean, weighted by the values in the second column of Table 7, as recommended earlier, was used. When none of the potentially biased estimates are deleted, the first estimate is obtained. If just the first survival estimate from each cohort is discounted, the second estimate is obtained.

Table 7

Estimates of Table 5 combined by years after first marking. Diagonal sums from Table 5, excluding the final two estimates of each cohort, are shown in column (1), while column (2) only excludes the last estimate for each cohort. The entry for year i in column (3) is the ratio of the column (2) entry for year $i+1$ over the column (1) entry for year i . The estimates of column (4) were obtained assuming that there is no heterogeneity in the probability of identification.

Years after first marking	Estimated number identified		$\hat{\phi}$ (3)	$\hat{\phi}$ (unadjust.) (4)
	(1)	(2)		
0				0.830
1	208.1		0.933	0.912
2	165.6	194.1	0.963	0.962
3	138.3	159.4	0.968	0.972
4	86.3	133.8	0.962	0.928
5	53.0	83.0	0.921	0.950
6	36.8	48.8	0.918	0.918
7	23.5	33.8	1.000	0.962
8		23.5		0.826

Table 8

Estimated annual probability of survival, humpback whales, Gulf of Maine data, 1976-86.

Bias adjustment	$\hat{\phi}$	(95% CI)	SE
None	0.909	(0.889, 0.930)	0.011
1st estimate deleted	0.939	(0.918, 0.957)	0.010
1st and last deleted	0.951	(0.929, 0.969)	0.010

If we also discard the last estimate of each cohort, the third estimate is obtained, which, in the light of the above results, we consider to be the least biased estimate. Hence, we estimate annual survival at 0.951, with 95% confidence interval (0.929, 0.969).

If estimates are deleted as above, to reduce the effects of heterogeneity, but age-independent survival is not assumed, the bias-adjusted estimates of ϕ from Table 7 may be used to plot a survival curve. Since the estimate of survival corresponding to the year following first identification is subject to bias, we start the estimated curve at one year after first identification. In Fig. 1, we show this curve, and confidence 'bands' for the curve, which are found by generating a percentile bootstrap confidence interval for the proportion surviving to each successive year. The proportions in the figure are plotted on a logarithmic scale, so that if survival is constant, the curve should be approximately linear. The early points in the figure are estimated from considerably more data than the later points, and bearing this in mind, there seems little evidence against the assumption of constant survival.

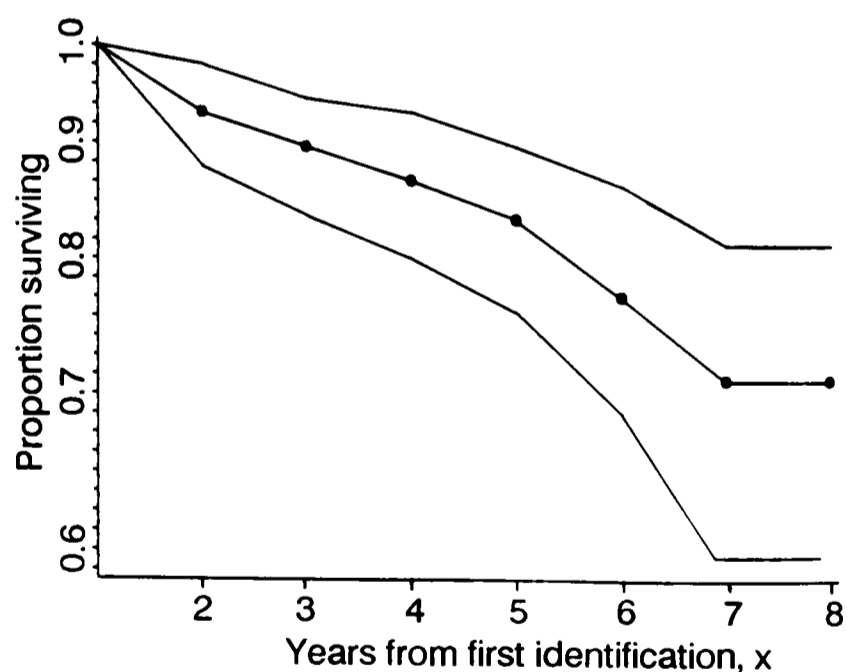

Fig. 1. Estimated proportion of a cohort surviving x years after first identification, conditional on having survived the first year, Gulf of Maine humpback data, 1976-86. Also shown is a 95% confidence 'band'.

If we attempt similar analyses on the Newfoundland/Labrador data, problems arise. Table 9 shows that estimated survival can be very low; the 1978 cohort shows an estimated reduction from about 140 animals to 25 between 1980 and 1981, and of just 38 animals in the 1981 cohort, only two are estimated to have survived until 1982. Table 4 shows that the estimated probability of sighting an animal in 1981 was very low, and the 1982 probability was lower than during 1978-80.

Table 9

Estimated number of surviving whales in each cohort for the Newfoundland/Labrador humpback data. The first number in each sequence is the number of whales originally comprising the cohort.

Cohort	Year				
	78	79	80	81	82
1978	268	142.5	142.5	25.7	25.7
1979		444	198.5	198.5	170.0
1980			199	115.0	108.0
1981				38	2.0

Hence, low effort in the later years appears to have exaggerated the effects of heterogeneity in the sighting probabilities. There was an organised sightings programme during 1978–80 in this area, and further work was carried out in 1982, but in a different part of the area (H. Whitehead, pers. comm.). After 1980, heterogeneity is therefore a major concern for these data, and non-random mixing of the whales in the area leads to underestimation of survival. The sequence of years is too short to allow estimation after deletion of the highly biased estimates. If analyses are carried out regardless, Table 10 is obtained, which is equivalent to Table 8 for the Gulf of Maine data. If the first and last estimate of each cohort are deleted, the annual survival rate is estimated to be 0.758, with 95% confidence interval (0.601, 0.956). We might expect this to be an underestimate, although the confidence interval spans most of the corresponding interval for the Gulf of Maine data. (Note that the second survival estimate in Table 10 exceeds the third, yet the upper confidence limit is smaller. This is a reflection of the odd distribution the estimates can exhibit when samples are small and heterogeneous, and a warning against using point estimate \pm two standard errors as an approximate confidence interval.)

Table 10

Estimated annual probability of survival, humpback whales, Newfoundland/Labrador data, 1978–83.

Bias adjustment	$\hat{\phi}$	(95% CI)	SE
None	0.637	(0.528, 0.768)	0.060
1st estimate deleted	0.815	(0.577, 0.903)	0.088
1st and last deleted	0.758	(0.601, 0.956)	0.077

DISCUSSION

Given that some whales are more easily identified than others, because they either possess distinctive markings or are more approachable or more easily photographed, it is not reasonable to expect researchers to ensure that all whales have the same probability of sighting in a given season in natural markings programmes. Confounded with these difficulties are the problems of defining the population that is being studied. Whales that remain in the study area for some time have a higher probability of identification than whales that visit the area only briefly. The Gulf of Maine humpback data show that estimation of survival rates at least is still possible in these circumstances.

However, the Newfoundland/Labrador data, which is the second most complete set of natural markings data for the Atlantic humpbacks, illustrates that it is not sufficient to have an intensive programme for only a few years. For reliable survival estimation, we require both that probability of identifying a whale present in a study area in a given year is high (perhaps of the order of 0.2 or higher, given the above analyses), and that the programme continues at this level of effort for many years – ideally at least ten. If the population size is large, a smaller probability of sighting might be acceptable, although many years of effort would still be necessary. The methods of this paper show how to reduce the effects of unequal probability of identification. However, if the sequence of years for which data are available is short, or if probability of identification is highly heterogeneous, serious underestimation of survival rates may still occur.

The requirements for estimating population size are different; the necessity for a long sequence of data is then less critical, but the assumption that the population is not subject to non-random temporary emigration is more critical. Hammond (1986) discusses this circumstance fully, and we do not consider it here.

ACKNOWLEDGEMENTS

I am grateful to Dr S. Katona and his group at the College of the Atlantic, Bar Harbor, Maine, for making the humpback data available for experimental analyses, and to the many enthusiasts and researchers who contributed to and collated the photographic database. Dr P. Hammond encouraged me to consider the problem and to attempt analyses of the data. I would also like to thank Dr J. Cooke, who reviewed the manuscript at very short notice, and Dr D. DeMaster and a second referee, both of whom provided constructive and helpful comments.

REFERENCES

- Buckland, S.T. 1980. A modified analysis of the Jolly-Seber capture-recapture model. *Biometrics* 36: 419–35.
- Buckland, S.T. 1982. A mark-recapture survival analysis. *J. Anim. Ecol.* 51: 833–47.
- Buckland, S.T. and Duff, E.I. 1989. Analysis of the Southern Hemisphere minke whale mark-recovery data. *Rep. int. Whal. Commn* (special issue 11):121–43.
- Buckland, S.T. and Garthwaite, P.H. in press. Quantifying precision of mark-recapture estimates using the bootstrap and related methods. *Biometrics*.
- Carothers, A.D. 1979. Quantifying unequal catchability and its effect on survival estimates in an actual population. *J. Anim. Ecol.* 48: 863–9.
- Clobert, J. and Lebreton, J.D. 1985. Dépendence de facteurs de milieu dans les estimations de taux de survie par capture-recapture. *Biometrics* 41: 1,031–7.
- Cormack, R.M. 1964. Estimates of survival from the sighting of marked animals. *Biometrika* 51:429–38.
- Hammond, P.S. 1986. Estimating the size of naturally marked whale populations using capture-recapture techniques. *Rep. int. Whal. Commn* (special issue 8): 253–82.
- Jolly, G.M. 1965. Explicit estimates from capture-recapture data with both death and immigration – stochastic model. *Biometrika* 52: 225–47.
- Jolly, G.M. 1982. Mark-recapture models with parameters constant in time. *Biometrics* 38: 301–21.
- Sandland, R.L. and Kirkwood, G.P. 1981. Estimation of survival in marked populations with possibly dependent sighting probabilities. *Biometrika* 68: 531–41.
- Seber, G.A.F. 1965. A note on the multiple recapture census. *Biometrika* 52: 249–59.
- Seber, G.A.F. 1982. *The Estimation of Animal Abundance and Related Parameters*. 2nd edn. Griffin, London.

A Birth-Interval Model for Estimating Cetacean Reproductive Rates from Resighting Data

Jay Barlow

*US National Marine Fisheries Service, Southwest Fisheries Center,
PO Box 271, La Jolla, California 92038, USA*

ABSTRACT

Three approaches are examined for estimating reproductive rates from data on multiple resighting of distinctly marked animals. The three approaches correspond to parameter estimation for three population growth models. Two of the approaches, parameter estimation for the Leslie matrix and geometric series models, are based only on known-aged individuals. A third approach, the birth-interval model, is developed making fuller use of available information. The birth-interval approach uses only known-aged individuals to estimate the first-birth ogive and uses all females with previous births to estimate the probabilities associated with various birth intervals. A Monte Carlo simulation is used to examine the bias and precision of the three methods given the quantity of data that is usually available in a multiple resighting study. All three approaches appear capable of giving unbiased estimates of population growth rate. The variance associated with such estimates is greatest for the Leslie model, less for the geometric series model and least for the birth-interval model.

INTRODUCTION

The number of repeated sightings of individually-identified cetaceans continues to increase. Many examples, including both large whales and delphinids, are discussed in this volume. Some studies will soon have 20 years of continuous data including records of thousands of sightings of identified individuals from particular populations. In many cases, the presence or absence of a calf is noted when observations are made. Thus, these sighting records include potentially valuable information on cetacean reproduction. In this paper, I examine methods for calculating reproductive rates from repeated sightings of known individuals.

The more obvious approaches used to estimate reproductive rate from resighting data tend to be biased. For example, one approach is to calculate the average number of mature females that give birth in a given year. Typically, the only measure of maturity is the presence of a calf in close proximity to the female. If the first observation of a particular cow with a calf were included in calculating an average birth rate for the population, that rate would be biased upwards. If the first observation were excluded, average birth rate would be biased downwards. A second approach is to calculate an average calving interval. Typically, these estimates are also biased. Mean calving interval is affected by a downward bias because one cannot expect to observe calving intervals that terminate after the study period. Mean calving interval is affected by an upward bias because some birth events will be missed (assuming some cows are not seen every year). The intent of this paper is to develop methods for estimating reproductive rates that are robust and unbiased.

I examine three methods for estimating reproductive rates from resighting data. (For this work, resighting data is defined as records of repeated sightings of distinctly marked individuals for which the presence or absence of a calf is unambiguously noted.) The first method is based on estimating the reproductive parameters of a Leslie matrix model. The second is based on estimating parameters for a geometric series model. Both use information collected

only from known-aged individuals. Because most individuals in a resighting study will not be of known age, these methods do not utilise all sources of information and might, therefore, be expected to be relatively imprecise. If parameters are correctly estimated, both are unbiased. I also present a third method which more fully utilises available information. This new approach (termed the birth-interval model) is compared to the other two approaches with respect to bias and precision.

METHODS

Reproductive rates have no clear meaning outside of the specific model to which they apply. There is no single definition of *the* reproductive rate of a population. Although one can invent statistics that are measures of reproductive output, it is difficult to judge bias or precision in the estimation of reproductive rate except in the context of a particular model. Methods for estimating reproductive parameters of three population growth models are presented below. The accurate estimation of population growth rate is the basis of measuring bias and precision. Bias and precision are evaluated using Monte Carlo simulations.

For all three models, it is assumed that mean survival rates of mature and immature individuals can be estimated from the same resighting data (Buckland, 1990).

Leslie matrix model

The Leslie matrix model is commonly used to model growth in age-structured populations. Details of the model are presented by Leslie (1945) and in most texts on population biology (e.g. Keyfitz, 1977; Pielou, 1977). In brief, the model is based on an age-structured projection matrix. When a vector of age specific population size is multiplied by this matrix, the result is the predicted vector of age-specific abundances one time unit later. Typically only females are modelled; however, because sex may not be known for the majority of individuals in a resighting study, I model males and females combined.

Table 1

Parameters used to construct the three population growth models considered here. Parameters subscripted with x or t are vectors.

Model	Parameters	Definition
Leslie Matrix	p_x	Survival rate of age-class x
	f_x^x	Fecundity rate of age-class x
Geometric Series	α	First sexually mature age class
	l	Survival from birth to age class
	\bar{p}	Mean survival rate of mature age classes
	m	Mean fecundity rate of mature age classes
Birth-Interval	p_x	Survival rate of age-class x
	β_x^x	Fecundity rate of age-class x for females without prior births
	γ_t	Mean fecundity at t time periods after a previous birth

The non-zero elements of the Leslie matrix include age-specific survival rates (in the first sub-diagonal) and age-specific fecundity rates (in the first row) (Table 1). The survival rates represent the probability of surviving from the beginning of one age class to the beginning of the next. The fecundity rate represents the expected number of offspring produced per individual of a given age at time t and which survive until one time unit later, at time $t+1$. The components of fecundity thus include reproductive rates and survival rates (the mother must survive from some arbitrary census time to parturition time and the offspring must survive from birth to the next census time).

I use here a formulation of the Leslie model that assumes census immediately after parturition. Thus, the only significant component of survival in the fecundity term is the survival of the mother from census to parturition. Let the first age class be called age class 1 and include individuals which are essentially newborns (remembering that births occurred immediately before census). This convention conforms to a formulation recommended by Goodman (1982).

Fecundity rates can be estimated from resighting data using known-aged individuals. I assume that cows and calves are observed together shortly after parturition. A crude birth rate, b_x , at age x is calculated as the number of calves observed with presumed mothers of age x , divided by all individuals (males and females) of age x . The fecundity rate, f_x , is then estimated as the product of the survival rate of females at a given age and the crude birth rate of the next age class:

$$f_x = p_x b_{x+1} \quad (1)$$

The population growth rate, e^r , is estimated as the one real-number solution to the discrete-time formulation of Lotka's equation

$$\sum_{x=1}^{\infty} (e^r)^{-x} l_x f_x = 1 \quad (2)$$

where $l_x = \prod_{i=1}^{x-1} p_i$ = survivorship from birth to age x

(Goodman, 1982). This rate is equivalent to the dominant Eigen value of the Leslie matrix.

Geometric series model

The geometric series model can be thought of as a collapsed form of the Leslie model. The model is named after an arithmetic identity that allows considerable

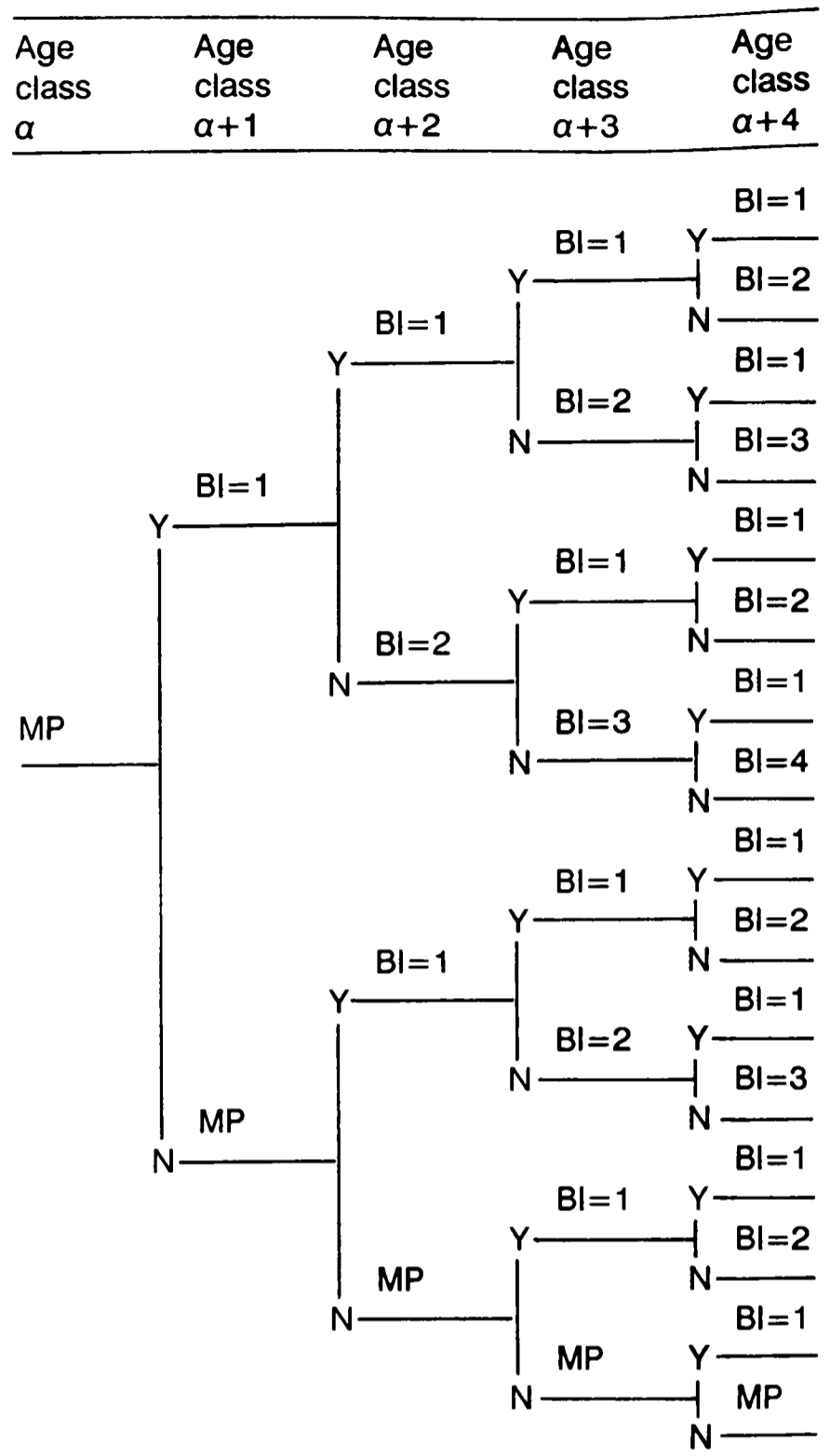

Fig. 1. Illustration of the Markovian method used to estimate Leslie matrix fecundity parameters from first-birth and birth-interval probabilities. Each node represents a decision point. At each node, the probability of having a calf, Y, or not having a calf, N, is given by either the first-birth probability, MP, for that age class (if no prior birth) or the birth-interval probability corresponding to the time, t , since the previous birth ($BI=t$). The probability of reaching each node is the product of all probabilities leading up to that node. The probability of giving birth for each age class is the sum of the probabilities of all nodes which result in a birth in that age class.

simplification in estimating population growth rates. The number of parameters is reduced to 4 (Table 1): the age at sexual maturation, α ; the survivorship from birth to that age, l_α ; the mean survival rate of mature animals, p ; and the mean fecundity rate of mature animals, m . Goodman (1984) provides a more detailed description of this model. Given the parameters for a Leslie model, it is possible to derive the parameters for the geometric series model. Typically, however, parameters are estimated independently of the Leslie model, and, because fewer parameters are needed, the geometric series model may perform better when sample size is limited. The population growth rate, e^r , is estimated as the solution to the equation

$$e^{r\alpha} - p \cdot e^{r(\alpha-1)} - m \cdot l_\alpha = 0 \quad (3)$$

(Goodman, 1984).

Again, the reproductive parameters of this model can be estimated from resighting data using known-aged individuals. The age at sexual maturation is simply one less than the age class of the youngest individual known to have given birth. The mean crude birth rate is the total number of calves born to known-aged individuals divided by the total number of known-aged individuals in age classes greater than or equal to the age of sexual maturation. The mean fecundity rate is estimated as this mean crude birth rate multiplied by the mean survival rate of mature females.

Birth-interval model

A third model, the birth-interval model, is developed here specifically to deal with the problems encountered using resighting data to estimate birth rates. The reproductive terms include two vectors (Table 1). The first vector, β_x , gives the probability that an individual of age x which has not given birth previously will give birth at age $x+1$. The second vector, γ_t , gives the probability of giving birth t years following the preceding birth. The first-birth probabilities, β_x , are estimated only from known-aged individuals. The birth-interval probabilities, γ_t , are estimated from all individuals which have given birth previously. Given estimates for these two sets of probabilities, the fecundity terms of a Leslie matrix can be estimated using Markov probability chains (Fig. 1). At this stage, population growth rates can be estimated as described above for the Leslie matrix.

First-birth and birth-interval probability vectors are estimated using iterative maximum-likelihood procedures. Birth-interval probabilities are estimated first. Calves are defined as young-of-the-year. An individual which is seen with a calf in one year can be classified in subsequent years as being in one of three states: (1) seen with a different calf; (2) seen without a calf; or (3) not seen at all. This information can be tabulated as given in Table 2. The probability, $Pr(t,j)$, of being in state j (of the three states given above) at time t after the birth of a calf can be calculated given estimates of the birth-interval probabilities (described above), the probability of being seen in a given year, and the mean survival rate. The likelihood of obtaining the aggregate sample is the product of the likelihoods of each individual observation. The likelihood function is thus

$$L = \prod_{t=1}^{\infty} \prod_{j=1}^3 (Pr(t,j))^{n(t,j)} \quad (4)$$

where

t = time since previously seen with calf,

j = observation state at time t and

$n(t,j)$ = number of individuals observed in state j at time t .

Table 2

Examples of the data used to estimate birth-interval probabilities. Values represent the number of individuals seen with a calf, seen without a calf, or not seen, as a function of time since a previous calf.

	Time since previous birth							.	.	.
	0	1	2	3	4	5	6			
No. with calf	195	76	70	70	68	60	61	.	.	.
No. without calf		23	30	25	22	34	24	.	.	.
Not seen		96	95	100	105	101	110	.	.	.

The probability of being seen in a subsequent year is assumed to decrease each year at a rate equal to one minus the mean survival rate. Furthermore, it is assumed that the mean survival rate and the probability of being seen have been estimated using standard mark-recapture techniques. The iterative approach to maximum likelihood proceeds as follows. First, a 'guess' is made for the birth-interval probabilities and the likelihood of the observed aggregate sample is calculated. Next, small changes are made to the estimates of birth-interval probabilities and the likelihood function is re-evaluated. This procedure is repeated until the values are found for birth-interval probabilities that maximise the likelihood function. In practice, I used the simplex algorithm to maximise the natural logarithm of the likelihood function. To reduce the number of parameters estimated, $Pr(t,j)$ was assumed to be constant for all t greater than three.

Table 3

Examples of data used to estimate first-birth probabilities. Values represent the number of known-aged individuals seen with or without a calf as a function of their age. The first reproductive age class is denoted as α .

	Age class								.	.	.
	1	2	.	.	.	α	$\alpha+1$	$\alpha+2$			
No. with calf	0	0	.	.	.	11	50	28	.	.	.
No. without calf	517	424	.	.	.	112	48	42	.	.	.

A similar approach was used to estimate first-birth probabilities. For each year they are observed, known-aged individuals can be classified in one of two states: (1) seen with a calf; or (2) seen without a calf. This information can be tabulated as given in Table 3. The probability of an individual of age x being with a calf, $Pr(x,1)$, is given by the crude birth rate, b_x . The probability of being without a calf, $Pr(x,2)$, is given as the complement of this rate, $1 - b_x$. The likelihood of observing an aggregate sample is the product of likelihoods of each individual observation. The likelihood function is thus

$$L = \prod_{x=1}^{\infty} \prod_{j=1}^2 (Pr(x,j))^{n(x,j)} \quad (5)$$

where

x = age of individual

j = observation state at age x

$n(x,j)$ = number of individuals observed in state j at age x .

Again, an iterative approach was used to find the maximum likelihood values for first-birth probabilities. First, a 'guess' is made for the probabilities of having a first calf at each age. These first-birth probabilities and the birth-interval probabilities estimated earlier are used to calculate the expected crude birth rates. The likelihood of the observed aggregate sample is calculated. Next, small changes are made to the estimates of first-birth probabilities and the likelihood function is re-evaluated. This procedure is repeated until the values are found for first-birth probabilities that maximise the likelihood function. Again the simplex algorithm was used to maximise the natural logarithm of the likelihood function. To reduce the number of parameters estimated for this study, $Pr(x,j)$ was assumed to be constant for all x greater than $\alpha+2$.

Monte Carlo simulations

Computer simulations were used to test the bias and precision of the birth-interval model relative to the more familiar Leslie and geometric series models. Simulations used full demographic stochasticity in which transition probabilities (birth or death) were applied to individuals. Initially a sample of n individuals was drawn from a population with known first-birth and birth-interval probabilities and known survival rates. The age distribution of the sample was drawn randomly with respect to the stable age distribution of that population. For each individual, the simulation program had variables to indicate age and sex and, for females, time since the previous birth. This initial population was then projected t time units into the future. At each time step, the probability of dying was evaluated for each individual. At each time step, the probability of having an offspring survive until the next time step was evaluated for each female. New births were distributed randomly among males and females.

A simulation of the process of sighting individuals was superimposed on this stochastic population projection. All individuals were assumed to have the same probability of being seen. At each time step, each individual was randomly assigned as being seen or not being seen based on this probability. A new calf was classified as being seen if its mother was seen. Individuals were classified as known-aged only if they were seen as calves.

Population growth rates were estimated using simulated sightings data collected over t years and using the Leslie, geometric series and birth-interval models. This process was repeated for 40 iterations, and the mean and variance in the resulting population growth rates were calculated for each of the three models.

Conditions for the simulations were designed to cover a feasible range of study conditions. The length of the simulated studies, t , ranged from 10 to 20 years. Values for the simulated population size, n , ranged from 100 to 200 individuals. Values for the probability of being seen ranged

Table 4

Survival rates, birth-interval probabilities, first-birth probabilities, and Leslie matrix fecundities used in simulations to yield a growth rate of 0.998. Fecundities were calculated from the other three vectors using Markovian probability chains.

Time/Age	Birth-interval probabilities	First-birth probabilities	Survival rates	Fecundity rates
1	0.75	0.00	0.66	0.00
2	0.90	0.00	0.74	0.00
3	0.90	0.00	0.80	0.00
4	0.90	0.00	0.84	0.04
5	0.90	0.10	0.88	0.23
6	0.90	0.50	0.91	0.37
7	0.90	0.90	0.93	0.36
8	0.90	0.95	0.94	0.37
9	0.90	1.00	0.95	0.37
10	0.90	1.00	0.95	0.37
11	0.90	1.00	0.95	0.37
12	0.90	1.00	0.94	0.37
13	0.90	1.00	0.92	0.36
14	0.90	1.00	0.89	0.35
15	0.90	1.00	0.86	0.34
16	0.90	1.00	0.80	0.31
17	0.90	1.00	0.73	0.29
18	0.90	1.00	0.63	0.25
19	0.90	1.00	0.51	0.20
20	0.90	1.00	0.00	0.00

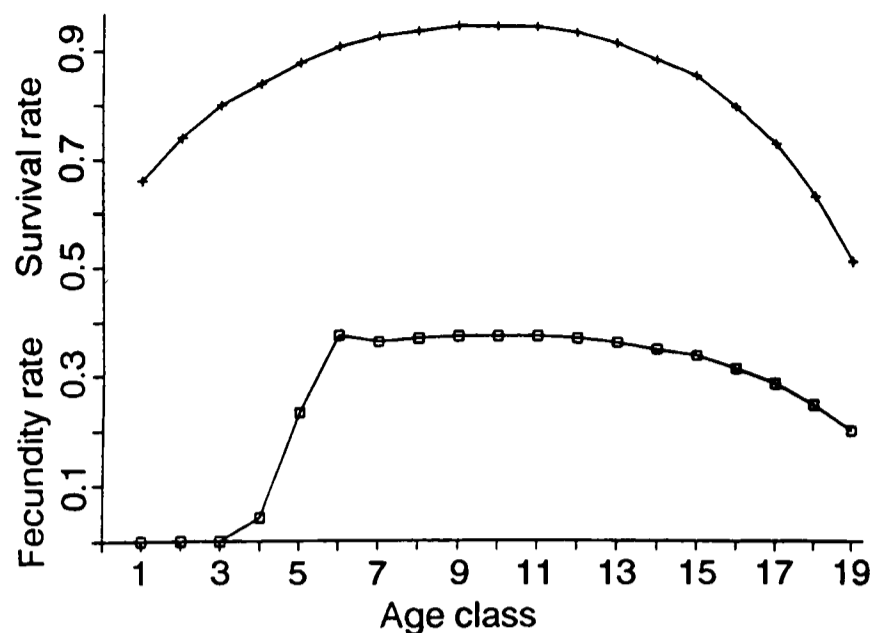

Fig. 2. Fecundity rates and survival rates used in simulation studies. Fecundity rates are as defined by first-birth and birth-interval probabilities (Table 4) and result in a population growth rate of 0.998. It is assumed that the survival rate of age-class 20 is zero.

Table 5

Survival rates, birth-interval probabilities, first-birth probabilities, and Leslie matrix fecundities used in simulations to yield a growth rate of 1.025. Fecundities were calculated from the other three vectors using Markovian probability chains.

Time/Age	Birth-interval probabilities	First-birth probabilities	Survival rates	Fecundity rates
1	0.90	0.00	0.66	0.00
2	1.00	0.00	0.74	0.00
3	1.00	0.00	0.80	0.04
4	1.00	0.10	0.84	0.23
5	1.00	0.50	0.88	0.40
6	1.00	0.90	0.91	0.41
7	1.00	0.95	0.93	0.42
8	1.00	1.00	0.94	0.43
9	1.00	1.00	0.95	0.43
10	1.00	1.00	0.95	0.43
11	1.00	1.00	0.95	0.43
12	1.00	1.00	0.94	0.43
13	1.00	1.00	0.92	0.42
14	1.00	1.00	0.89	0.40
15	1.00	1.00	0.86	0.39
16	1.00	1.00	0.80	0.36
17	1.00	1.00	0.73	0.33
18	1.00	1.00	0.63	0.29
19	1.00	1.00	0.51	0.23
20	1.00	1.00	0.00	0.00

from 0.5 to 1.0. Birth-interval and first-birth probabilities and survival rates were chosen to be representative of a stable population of a marine mammal with a lifespan of approximately 20 years (Table 4, Fig. 2). Variations on this life table included increasing birth rates to yield a population growth rate, e^r , of 1.025 (Table 5), and increasing birth and survival rates to yield a population growth rate of 1.062 (Table 6).

RESULTS

The mean population growth rates estimated from simulations are given in Table 7 for each of the three models. The expected population growth rate (based on the underlying survival and fecundity schedules) and the realised mean growth rates of the populations are also given. Standard errors in the estimation of population growth rates are given in Table 8 for each of the three models.

Table 6

Survival rates, birth-interval probabilities, first-birth probabilities, and Leslie matrix fecundities used in simulations to yield a growth rate of 1.062. Fecundities were calculated from the other three vectors using Markovian probability chains.

Time/Age	Birth-interval probabilities	First-birth probabilities	Survival rates	Fecundity rates
1	0.90	0.00	0.75	0.00
2	1.00	0.00	0.80	0.00
3	1.00	0.00	0.85	0.04
4	1.00	0.10	0.87	0.23
5	1.00	0.50	0.89	0.40
6	1.00	0.90	0.91	0.41
7	1.00	0.95	0.93	0.42
8	1.00	1.00	0.94	0.43
9	1.00	1.00	0.95	0.43
10	1.00	1.00	0.95	0.43
11	1.00	1.00	0.95	0.43
12	1.00	1.00	0.94	0.43
13	1.00	1.00	0.92	0.42
14	1.00	1.00	0.89	0.40
15	1.00	1.00	0.86	0.39
16	1.00	1.00	0.80	0.36
17	1.00	1.00	0.73	0.33
18	1.00	1.00	0.63	0.29
19	1.00	1.00	0.51	0.23
20	1.00	1.00	0.00	0.00

Table 7

Population growth rates estimated from Monte Carlo simulations based on three methods for estimating birth rates. Expected growth rates were determined by the underlying survival and birth rates.

Expected growth rate	Prob. being seen	Study period	Sample size	Realized growth rate	Birth-interval model	Leslie matrix model	Geometric series model
0.998	0.5	10	100	1.003	0.992	1.009	0.997
		20	200	0.995	0.994	0.989	0.993
	1.0	10	100	0.997	0.993	0.984	0.979
		20	200	0.997	0.997	0.993	0.995
1.025	0.5	20	200	1.024	1.023	1.024	1.030
	1.0	20	200	1.023	1.025	1.028	1.032
1.062	0.5	20	200	1.054	1.059	1.061	1.062
	1.0	20	200	1.054	1.060	1.063	1.063

In general, biases in the estimation of population growth rates are small for all three models. Mean growth rates from each of the three models (Table 7) differ from the mean realised growth rates by less than the standard error of the estimates (Table 8).

The precision of the three models in estimating population growth rates shows a consistent order. The standard errors for the birth-interval model are consistently lower than those for the geometric series model, which are lower than those of the Leslie matrix model (Table 8). All methods perform better with higher population growth rates. This improved performance is probably a result of greater sample size (although all simulations started with the same population size, a growing population would have more simulated sightings over the course of the study).

Because the simulation study was stochastic, the realised growth rates did not exactly equal the growth rate characteristic of the underlying life table (Table 7). Deviations from the expected growth rates were small, however, indicating no systematic biases in the

Table 8

Standard errors of population growth rates estimated from Monte Carlo simulations based on three methods for estimating birth rates. Expected growth rates were determined by the underlying survival and birth rates.

Expected growth rate	Prob. being seen	Study period	Sample size	Realized growth rate	Birth-interval model	Leslie matrix model	Geometric series model
0.998	0.5	10	100	0.017	0.024	0.034	0.027
		20	200	0.010	0.009	0.020	0.015
	1.0	10	100	0.017	0.019	0.039	0.024
		20	200	0.009	0.004	0.015	0.010
1.025	0.5	20	200	0.008	0.004	0.017	0.015
	1.0	20	200	0.010	0.002	0.010	0.008
1.062	0.5	20	200	0.008	0.006	0.014	0.013
	1.0	20	200	0.008	0.003	0.008	0.007

construction of the simulation model. It is interesting to note that the standard error of estimated growth rates from the birth-interval model is, in most cases, smaller than the standard error of the realised population growth rate.

DISCUSSION

The purpose of this paper was to test the relative bias and precision of three methods for estimating reproductive rates from individual resighting data. The simulation study was not intended to estimate accurately the precision that should be expected in the application of these methods to data collected in the field. Survival rates were assumed to be known in the simulation and would have to be estimated if these methods were applied to field data. Simulations did, however, cover a range of sample sizes and study durations that are attainable or have been attained in field studies.

Leslie matrix model

The assumptions of the Leslie matrix model are the least restrictive of the three models considered here. The primary assumption (common to all three models) is that the sample of individuals that are sighted is representative of the population being studied. Estimation of reproductive rates for the Leslie model does not require any implicit assumptions about the age distribution of the population. This advantage may be outweighed by the restrictive numbers of known-aged individuals available for the estimation of reproductive rates. Ages that are greater than the study period will not be represented at all. Given the longevity of cetaceans, very long-term studies may be necessary in order to estimate accurately fecundities for all age classes using the Leslie model.

Geometric series model

The geometric series model shares a common weakness with the Leslie model; birth rates for both are based on small samples of known-aged individuals. Furthermore, when estimating mean birth rate for the geometric series model there is an explicit assumption that the population has a stable age distribution. If, after maturation, birth rates change appreciably with age and if the age distribution is not stable, the estimation of asymptotic population growth rate will be biased. This bias may be small, however, and the lower variance of the geometric series model would make it preferable to the Leslie model in most applications.

Birth-interval model

In estimating birth-interval probabilities, it is assumed that the sample has a stable age distribution. If not, and if birth-interval probabilities change with age, the resulting estimate of population growth rate will be biased. In addition to this assumption (which was the same for the geometric series model) there is the additional assumption that the probability of being seen is the same for all individuals. Based on previous field studies, this is almost certainly not true. Although the mean probability of being seen may be estimated very accurately, individual heterogeneity in sighting probability can lead to serious biases. (This is separate from the assumption that the probability of being seen is independent of the presence of a calf, an assumption that was common to all methods.) Additional work is needed to determine whether sighting heterogeneity would bias the estimation of birth-interval probabilities. If this bias is present, it is probably small. The birth-interval model is still likely to be the best approach for estimating reproductive rates from resighting data.

Simulation studies

The simulation studies here do not account for all sources of error and imprecision that are likely to be encountered in estimating growth rates from field data. First (and probably most importantly), I assumed that survival rates were known. Because I wanted to measure the accuracy in estimating reproductive rates, I did not want to add this additional source of random error. Methods for estimating age-specific survival rates from resighting data have not been examined in depth. It is likely that some method of estimating an aggregate survival rate for all age classes (Buckland, 1990) may have to be incorporated into the models presented here. If age-specific rates are not available, estimates of population growth rates may be sensitive to departures from a stable age distribution.

These simulation studies may also have overestimated the number of known-aged individuals that could be obtained in any field study. I assumed that any individual seen as a calf could later be identified as a known-aged individual. It is likely that many young animals have no distinguishing marks and thus would not be recognised as adults. This would affect all three models, but would affect the Leslie and geometric series models more because they are entirely dependent on known-aged individuals.

No attempt was made to analyse the effect of deviations from a stable age distribution on the estimation of population growth rate. Such deviations would affect each model differently. Also, changes in reproductive rates with age were not explicitly modelled. The number of permutations needed to simulate these effects is overwhelming and beyond the scope of this work. Because the Leslie model has fewer assumptions, it would be less affected than would the other models. Whether this advantage would outweigh the disadvantages of this method would depend on the specific application.

Future research

Methods for estimating reproductive rates for each of the three models could benefit from additional studies. For the Leslie model, it is likely that precision can be increased if

age groups are lumped into larger age categories. This is especially true for the older age classes for which the sample of known-aged individuals is very small. As age classes are combined, however, the assumption of a stable age distribution becomes important. Simulation studies could be used to examine the trade-offs between greater precision and violations of this assumption.

For the geometric series model, it may be possible to use individuals of known-minimum-age to augment the sample of known-aged individuals in calculating the mean crude birth rates and mean survival rates. This approach could, however, lead to biases. By adding individuals whose minimum age is greater than the age at sexual maturation, the sample may be weighted towards older mature animals. This would introduce a bias if birth rates or survival rates change appreciably with age. [Mean birth rates and survival rates should be estimated as an average of age-specific rates that are weighted by the actual number of individuals in each age class (Goodman, 1984)]. This latter source of bias should be balanced, however, against the likelihood that older individuals would not be represented in the sample at all unless known-minimum-aged individuals are included. This approach deserves further consideration.

For the birth-interval model, the largest problem (alluded to above) is likely to be heterogeneity in the probability of resighting individuals. This problem should be examined using simulation studies.

For all three approaches, simulation studies should be extended to include the estimation of survival rates. Only then could a realistic appraisal be made of the standard error of estimating population growth rates from resighting data. Based on the results presented here, the component of error due to the estimation of reproductive rates is small. The possibilities of estimating population growth rates from resighting data should be viewed with considerable optimism.

ACKNOWLEDGEMENTS

I thank P. Hammond for originally suggesting that I should present this material at the IWC symposium. Helpful suggestions and comments were made by D. Goodman and B. Taylor. Drafts of this manuscript were reviewed by L. Ballance, D. DeMaster, D. Goodman, R. Holt, A. Jackson and two anonymous reviewers.

REFERENCES

- Buckland, S.T. 1990. Estimation of survival rates from sightings of individually identifiable whales. Paper SC/A88/ID5 (published in this volume).
- Goodman, D. 1982. Optimal life histories, optimal notation, and the value of reproductive value. *Am. Nat.* 119(6):803-23.
- Goodman, D. 1984. Statistics of reproductive rate estimates, and their implications for population projection. *Rep. int. Whal. Commn* (special issue 6):161-73.
- Keyfitz, N. 1977. *Introduction to the Mathematics of Populations with Revisions*. Addison-Wesley Publ. Inc., Reading, Mass. 490pp.
- Leslie, P.H. 1945. On the use of matrices in certain population mathematics. *Biometrika* 33:183-212.
- Pielou, E.C. 1977. *Mathematical Ecology*. John Wiley & Sons, New York. 385pp.

Reproduction in the Humpback Whale (*Megaptera novaeangliae*) in Hawaiian Waters, 1975–1988: the Life History, Reproductive Rates and Behavior of Known Individuals Identified through Surface and Underwater Photography

Deborah A. Glockner-Ferrari and Mark J. Ferrari

Center for Whale Studies, PO Box 1539, Lahaina, Maui, HI 96767, USA
and Wildlife Conservation International, New York Zoological Society, Bronx, NY 10460, USA

ABSTRACT

Humpback whales were studied in the waters off the west coast of Maui, Hawaii during the period 1975–88 using photographic techniques. Using surface and underwater photographs of body pattern characteristics, 584 adults and 268 calves were identified. Using photographs of the undersurface of the flukes, 210 adults and 2 calves were identified. Resighting histories were compiled for 69 individuals. Intervals between first and last sightings ranged from 1–13 years. One known male, observed in ten different years over a 13 year interval, was estimated to be a minimum of either 18 or 23 years of age (depending on certain assumptions) when last sighted. Of 34 resighted mothers, 31 produced more than one calf: 1 had seven calves, 1 had six calves, 2 had four calves, 6 had three calves and 21 had two calves. Maximum calving intervals were 1 year (n=7), 2 years (n=17), 3 years (n=8), 4 years (n=9), 5 years (n=5), 6 years (n=1), 7 years (n=1) and 9 years (n=2). Of the calves, 52.9% were males and 47.1% females. One male calf was later resighted at 6, 7 and 10 years of age. Evidence suggests that this individual reached sexual maturity by age seven. A decrease in the occurrence of mothers and calves in nearshore waters off the west coast of Maui, Hawaii during the 1977–88 study period was demonstrated.

INTRODUCTION

Photographic techniques have been successfully applied in recent years by numerous researchers to study living whales in their natural environment. The humpback whale, (*Megaptera novaeangliae*) a species whose worldwide population may number less than 10% of its pre-exploitation size (Allen, 1980), has been the focus of many such studies.

During the 1970s, several workers (e.g. Kraus and Katona, 1977; Katona, Baxter, Brazer, Kraus, Perkins and Whitehead, 1979) demonstrated that individual humpback whales in the North Atlantic could be identified from photographs of the pigment patterns on the ventral surface of their flukes and the shapes of their dorsal fins.

Meanwhile, in the North Pacific, in 1968, Jurasz and Jurasz (1978) had begun to identify individual humpback whales off Southeast Alaska in the same way. Researchers in the North Pacific have since widely employed these and other photo-identification techniques to identify individual humpback whales and observe their behavior (e.g. Herman and Antinoya, 1977; Glockner, 1978; 1983; Tyack, 1981; Darling, Gibson and Silber, 1983; Glockner-Ferrari, 1982; Glockner and Venus, 1983; Baker and Herman, 1984; Glockner-Ferrari and Ferrari, 1984; 1985; Mobley and Herman, 1985; von Ziegesar and Matkin, 1985; 1986; Darling and Morowitz, 1986; Cabbage, Calambokidis, Stieger, Balcomb and Bloedel, 1990; Flores, 1987; Urban and Aguayo, 1987), to determine reproductive rates (e.g. Glockner-Ferrari and Ferrari, 1984; 1985; Baker, Perry and Herman, 1987; Straley, 1990), to record humpback vocalisation and song (e.g. Payne, 1982; Payne, Tyack and Payne, 1983; Silber, 1986) and to establish migratory patterns (Baker and Herman, 1981; Darling and Jurasz, 1983; Baker *et al.* 1985, 1986; Darling and McSweeney, 1985).

The waters surrounding the Hawaiian Islands provide one of the major wintering grounds for humpback whales in the North Pacific (Dawbin, 1966; Rice, 1974, 1978; Herman and Antinoya, 1977; Wolman and Jurasz, 1977; Rice and Wolman, 1978). The relative accessibility and clarity of these warm waters also provide a unique natural laboratory in which to study living humpback whales, not only from above the surface of the water but also below it.

Our research has differed from that of others in that it focuses on observing individual animals and their behavior over prolonged periods from above and below the surface of the water. Following pilot studies in 1975 and 1976, Glockner and Venus (1983) began an intensive study in 1977 of the biology and behavior of humpback whales in the waters off the west coast of Maui, Hawaii. Initially, efforts were focused on the photographic identification and sexing of mothers, calves and escort whales (Glockner, 1978; 1983; Glockner and Venus, 1983). Subsequently, individually recognisable whales were resighted and their behavior and reproductive status recorded over successive years. The project evolved into a long-term study of the social roles and life histories of individual whales and the reproductive cycle of sexually mature females (Glockner-Ferrari and Ferrari, 1984; 1985).

In this paper, we present the results of our study from 1975–88, on the resighting histories of individual whales, the reproductive rates of sexually mature females, the sex ratio of calves, the growth of a calf to maturity and the changing distribution of mothers and calves from the west coast of Maui.

METHODS

Field study

Our study area consisted of approximately 350km² in the waters of the Auau Channel, extending along the west

coast of Maui, northward to Kekaa Point, southward to McGregor Point, and westward towards Lanai (Fig. 1). Following pilot studies conducted in 1975 and 1976, we have spent an average of 59.5 days (SE 7.63) at sea each year during the period 1977–88 in the months of January through May, observing humpback whales (Table 1). Prior to 1980, we used small inflatable boats, ranging from 2.7m to 3.2m in length, as a platform from which to observe the whales, launched from the West Maui coast near to where we had sighted whales from shore (Glockner and Venus, 1983; Glockner-Ferrari and Ferrari, 1985). The study area consisted of waters usually within two miles of the West Maui coastline from Kekaa Point to McGregor Point, but occasionally calm seas permitted coverage to four miles offshore. On four days in 1979, one of us (DGF) accompanied J. Darling in a 5.2m Boston Whaler, extending the area covered to Lanai.

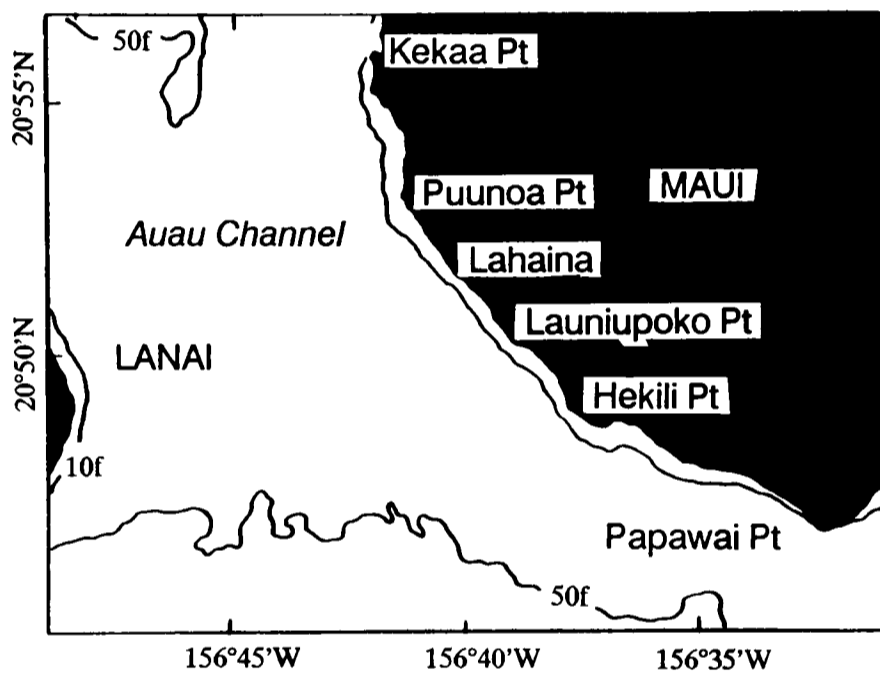

Fig. 1. Map of study area.

Table 1

Number of days spent on ocean observing whales, 1977–88.

	Jan	Feb	Mar	Apr	May	Total
1988	7	20	23	15	6	71
1987	8	15	17	20	5	65
1986	6	10	25	17	6	64
1985		19	18	20	6	63
1984	1	18	24	19	1	63
1983		15	16	14	5	50
1982		13	19	16	11	59
1981		11	18	16		45
1980	9	17	14	22		62
1979	9	10	19	11	1	50
1978	13	17	13	14		57
1977	9	17	14	19	6	65
Total	62	182	220	203	47	714
Ave Days/Yr	5.2	15.2	18.3	16.9	3.9	59.5

In 1980, the use of a larger inflatable *Zodiac* enabled us to extend the waters covered. The larger study area included the nearshore waters studied during the previous years. The coastal waters were surveyed daily from various lookout points along the west coast of Maui for the

presence of whales, prior to launching the inflatable from Mala Wharf on the north side of Puunooa Point each day conditions permitted. In 1981 and thereafter, we observed whales from a 4.7m *Zodiac* MkIII GR inflatable boat powered by a *Johnson* 35hp or 30hp outboard motor.

Our efforts were biased primarily towards observing and photographing mothers and calves, although individuals and groups of whales not containing mothers and calves were also photographed. Since sampling was not random, our data do not reflect the sexual or group composition of the population.

If we did not initially sight from shore any groups containing a mother and calf, we would usually travel in nearshore waters southward towards Hekili Point. If winds and seas allowed, we would continue south toward McGregor point, then head offshore and back towards Lanai. Occasionally, the pattern of travel was reversed. Exact searches were not defined.

In 1981, we established a CB radio communications network with vessels and shore observers that provided us with sighting information throughout all portions of our study area. The vessels operated 2.5–4.0hr whalewatching tours, often searching the West Maui coastal waters and regularly returning to Lahaina harbor to reload passengers. Some of the vessels also conducted snorkeling and diving tours along the West Maui coastline. Sighting coverage of nearshore waters was extensive. By 1986, our path of travel was often determined after reviewing the sighting information we received from the communications network and our own shore observations.

Throughout the 1975–88 period, upon approaching a group of whales, we would observe them from the surface at a distance of approximately 50–100m. Depending upon their behavior, we would gradually approach closer, photographing the whales from the surface and then slowly enter the water with snorkeling equipment and cameras to take underwater photographs. The geographic locations of whales sighted were determined by visually approximating their distances from the West Maui shoreline.

In addition to the long-term study conducted in Hawaiian waters, we conducted a pilot study in the waters off Southeast Alaska from 1–8 September 1987. Surface photographs of individual whales were taken from aboard a 15.2m motor vessel, the *C'est Si' Bon*, and a 5.5m *Zodiac* inflatable.

Each year, we progressively upgraded the type of camera equipment used. A *Kodak* Instamatic 126, a *Nikon* FE, and two *Nikon* F2 camera bodies with motor drives coupled with 105mm, 180mm, 200mm, 300mm and 50–300mm zoom lenses were used to take still photographs. Three *Nikonos* II camera bodies, a *Nikonos* III body and a *Nikonos* V body with 28mm, 20mm and 15mm lenses were used for underwater photography. Motion footage was obtained with a *GAF* super 8 movie camera and a *Bolex* 16mm movie camera with an *Angenieux* 12–120mm zoom lens, a *Kodak* super 8 movie camera in an underwater housing, and a *Kodak* K-100 16mm movie camera with a 10mm *Kern-Switar* lens in an underwater housing. *Kodachrome* 64 35mm color film, *Professional Kodachrome* 200 35mm color film, *KMA* 464 super 8 movie film, and *Kodak* negative stock 7291 16mm movie film were used.

During the period 1975–88, we took over 62,900 surface and underwater photographs to identify individual humpback whales and over 750m of super 8 motion film and 6,100m of 16mm motion film to record their behavior.

Data analysis

The photographs and field notes obtained throughout the study period were studied in detail for identification of individual humpback whales. Photographing the whales from both the surface and underwater, we use a combination of several morphological features to confirm their identification, including the pigment patterns of the flippers, throat grooves, abdomen, flanks, and flukes, the shape of the dorsal fin, and the spatial-numerical pattern of the lip grooves; morphological features (e.g. presence of lobe following genital slit) were also used to identify sex (e.g. Glockner, 1978; Glockner and Venus, 1983; Glockner-Ferrari and Ferrari, 1985; 1987). We applied the term 'body pattern identification' to this photo-identification technique. As we expanded our project, we also concentrated on obtaining surface photographs of the dorsal fins and flukes of whales that we were not able to photograph underwater. Emphasis has so far been placed on the analysis of underwater photographs. We have only partially analysed our data from the period 1986-88. Only photographs of females with calves and photographs of males that were recognised upon sight have been analysed thus far for this period.

Photographs of the undersurface of flukes of individual whales have been analysed only for the 1984-85 field seasons. To facilitate analysis, black and white negatives and prints were made from the color transparencies. Three identification catalogues were produced, one containing black and white photographs depicting the various body patterns of individual whales, one containing black and white photographs depicting the pigment pattern of the undersurface of the flukes, and one containing color transparencies of each whale that we identified. Prints depicting the undersurface of the flukes of individual humpbacks were submitted to the National Marine Mammal Laboratory's computerised photo-identification system for the North Pacific (Mizroch, Beard and Lynde, 1990).

A reference number was assigned to each whale identified through body pattern photo-identification and through fluke photographs. Whales identified by both body pattern and fluke photo-identification were cross-referenced. Using a classification system developed in 1977, we categorised each identified whale according to the pigmentation pattern on its flippers, flukes and flanks, the spatial-numerical pattern of its lip grooves and its sex. For the purpose of tallying individual identifications, whales were classified as either calves or adults.

All photographs were reviewed for resightings of individual whales. The total number of individual whales was determined and the number of mothers and calves was tallied. All resightings of individuals were recorded. Photographs of resighted females were examined to determine how often each female was accompanied by a new calf.

The geographic locations of mothers and calves sighted were recorded and compared throughout the years. Changes were noted in the distribution of mothers and calves in nearshore waters. The term mother-calf 'set' is used in referring to sightings of mothers and calves. We define a mother-calf set as any group containing a mother and a calf, including mother-calf pairs, mother-calf-escort trios and any multiple member groups containing a mother and calf.

RESULTS

Individual identification

Identifications

Through detailed comparisons of slides depicting body pattern characteristics taken during 1975-88 in Hawaiian waters, a total of 584 adults and 268 calves have thus far been identified. Through analysis of slides showing only fluke pigment patterns taken in 1984 and 1985, 210 adults and 2 calves have been identified. Of these, 28 adults and

Table 2

Summary of new identifications and resightings of whales identified by body pattern photographs. The number of new identifications each year are indicated to the left of the diagonal line. Parentheses () indicate calves or whales that were previously seen as calves. The numbers preceding the parentheses do not include the numbers of calves indicted by the parentheses. The last column gives the total number of unique individuals resighted from the initial year of identification. NOTE: The year 1976 is omitted from the table as no identifications have been made from photographs thus far analysed.

Initial year of identification	Number of individual whales resighted from previous years													No. of unique individuals
	1975	1977	1978	1979	1980	1981	1982	1983	1984	1985	1986	1987	1988	
1975	2	2	2	1	0	1	0	1	1	1	1	1	1	2
1977		55 (14)	2	2	4	4	3	1	0	2	2	2	1	10
1978			33 (18)	1 (2)	3 (1)	1	1	1	1 (1)	1 (1)	0	1	(1)	9 (3)
1979				38 (18)	2	5	3	1	5	4	4	1	3	11
1980					61 (15)	2	2	0	0	2	2	0	2	6
1981						70 (21)	0	1	1	2	0	0	1	5
1982							61 (21)	5	1	1	0	0	2	6
1983								84 (21)	1	1	1	1	1	3
1984									57 (22)	2	0	1	2	5
1985										51 (23)	2	2	2	5
1986											13 (20)	1	3	3
1987												27 (32)	1	1
1988													32 (43)	
Total number of individuals resighted, 1975-88: 66(3)														
Cumulative sum of unique individuals	2	57 (14)	90 (32)	128 (50)	189 (65)	259 (86)	320 (107)	404 (128)	461 (150)	512 (173)	525 (193)	552 (225)	584 (268)	

both calves were also identified by body pattern photographs. The remaining 182 adults identified by fluke photographs may of course include individuals identified by body pattern characteristics. Seventy-nine individuals were identified by fluke photographs from the waters of Southeast Alaska in September 1987.

Resightings

Of the 584 adults identified by body pattern characteristics, 66 (11.3%) were sighted in two or more years (Table 2). Of the 268 calves similarly identified, only 3 (1.1%) were reidentified in one or more years following their birth.

Of a total of 69 resighted whales, 34 were known mothers. Two known mothers were observed in seven different years, 2 in five years, 3 in four years, 3 in three years and 24 in two years. The intervals between first and last sightings of these females ranged from one to eleven years (mean 4.9 years, SE 2.82).

Of the 35 resighted whales not observed as mothers, the sex of 21 was determined; 18 were males, 3 were females. Of the remaining 14 individuals, 12 were probable males based on their social roles as either escorts, challengers to an escort and/or singers (Tyack and Whitehead (1983) suggest that singing is a strategy used by humpback whales for gaining access to females). Of these 30 known or presumed males, 17 were observed in two years, 7 in three years, 4 in four years, 1 in six years and 1 in ten different years (Table 3). The intervals between first and last sightings of these individuals ranged from 1–13 years (mean 4.4 years, SE 3.03).

Whale 1601, a known male first seen in 1975, has been observed in ten different years over a thirteen year interval. He was first observed in a large active group of whales involved in aggressive competition with other males, vying for position of escort to a female. Numerous scars covered his body and chunks of flesh were missing from his dorsal fin, flippers and the trailing edge of his flukes, an indicator of his likely previous presence in other active groups and a sign of probable sexual maturity. He was large and similar in size to the other active group members, appearing to be physically mature. We most recently sighted this individual during 1988: on 1 March escorting a female with a calf; and on 26 March in the center of a group of whales actively engaged in an aggressive encounter.

Through examination of corpses of male humpback whales taken off the coast of Australia, Chittleborough (1959; 1965) suggested that the majority of males attain sexual maturity at five years of age and physical maturity at ten years of age. Therefore, whale 1601 was probably at least 5 to 10 years old in 1975 and at least 18 to 23 years old, when last sighted in 1988. Chittleborough's determination of age is based on his belief that four laminae (two growth layer groups) in the earplug of a humpback whale constitute an annual growth layer. Clapham and Mayo's (1987a) observations of two known-age female humpback whales in the North Atlantic that attained sexual maturity at four and six years of age, respectively, support Chittleborough's age determination data. However, Lockyer (1984) reports that others believe only two laminae occur per year. If the latter assumption is correct, Chittleborough's data would suggest that male humpbacks attain sexual maturity at 10 years of age and physical maturity at 20 years. Whale 1601, when most recently observed in 1988, would then have been a minimum of either 23 or 33 years of age.

Table 3

Resightings of individuals other than known mothers identified by body pattern photographs. * indicates individual was photographed in Hawaii in the year specified. * A indicates individual was photographed in Alaska.

Whale	Sex	75	77	78	79	80	81	82	83	84	85	86	87	88
1015	M	*	*	*	*									
1601	M	*	*	*			*		*	*	*	*	*	*
1013			*				*		*					
1417	M		*			*	*							
1016			*		*									
1602	M		*			*								
2005	M			*				*						
2405				*			*							
2601				*		*								
1508				*						*				
1006C8				*	*	*								
2206C8	M		*						*	*			*	
2218C8	F			*	*									
3010	M		*			*			*	*			*A	*
3412	M			*					*	*	*			
3005	M			*		*								
3416				*	*									*
5035					*	*	*							
4020	M				*	*	*				*			
4056					*							*		*
5403						*	*	*						
5051	M					*				*				
5620	M					*				*				
6010	M							*	*					*
6064								*	*					
6020	M							*	*					
6032								*	*					
7026	M							*	*	*			*	
7028	M							*				*		
9025	M							*		*				
9017								*	*					
9018								*	*				*A	*
9301	F							*	*					
11234	F										*	*	*	
11408	M											*	*	

Resightings between Alaska and Hawaii

Of the 79 individuals we photographed in Alaska in September 1987, six had been previously sighted in Hawaii. Whale 3010, a known male characterised by a large white scar on its back anterior to the dorsal fin, and whale 9018, a known singer and probable male, were observed in Hawaiian waters over nine and three year intervals respectively. Both were photographed in Alaska within a two day period and within approximately 7km of each other. The following winter, we resighted both whales in the same location off West Maui on separate days.

Reproductive cycle

Calving intervals of known mothers

Of 34 known mothers that have been identified in two or more years during our study period, 31 have produced more than one calf: 1 had seven calves, 1 had six calves, 2 had four calves, 6 had three calves and 21 had two calves, totalling 81 calves.

A total of 87 sightings of these 31 mothers have produced information on 50 calving intervals (Table 4). Determination of a calving interval, defined as the interval in years between the observed calves of a female (Clapham

Table 4

Calving intervals of known mothers sighted in two or more years. C denotes that the female was photographed with a calf in the specified year. Y denotes that the female was accompanied by her yearling Y* denotes that a "yearling-size" whale accompanied the female. It is unknown if this whale was the female's offspring. * denotes that the female was sighted, but that neither a calf nor a yearling were present.

Whale	77	78	79	80	81	82	83	84	85	86	87	88	I (yrs)
2210	*	C		C	C				C		C	C	10
1006	*	C	Y			C			C				7
1205	C					C				C	C		10
1210	C				Y*								
1213	C			C		C							5
1214	C									C			9
2203		C		C									2
2204		C					C						5
2209		C									C		9
2212		C		C									2
2218		C	Y										
3201			C						C				6
3204			C					C					5
3205			C		C				C				6
3208			C	C	C	C		C		C		C	9
3210			C		C	C							3
3006			*		C			C	*	C			5
3214			C			C				C			7
4201				C	C								1
4204				C		C				C		C	8
4212				C					C				5
5207					C		C						2
5216					C							C	7
6204						C	*	C				C	6
6217						C			C				3
7221							C					C	5
8209								C				C	4
8212								C				C	4
8221								C			C		3
9001									*	C			
9210									C		C		2
9217									C			C	3
10206										C		C	2
10219										C		C	2

I = Interval in years between first and last sightings with a calf

and Mayo, 1987b; Baker, Perry, and Herman, 1987), is dependent upon the continuous resighting of a female in years between calving. Our resighting histories of known mothers are often not continuous. Thus, we calculated the following maximum calving intervals, the maximum number of years possible between calving: 1 year (n=7), 2 years (n=17), 3 years (n=8), 4 years (n=9), 5 years (n=5), 6 years (n=1), 7 years (n=1), and 9 years (n=2).

The continuous resighting history of six females yielded nine observed calving intervals: seven of one year and two of two years. The mean calving interval was 1.2 years (SE 0.44).

Four known females have had a one year reproductive cycle in which postpartum ovulation occurred with conception. A close examination of the reproductive history of these females shows that they have produced two, four, six and seven calves respectively. The intervals between first and last observed calving ranged from nine to ten years, for three of the four females.

Two females, 6204 and 3006, had a known two year reproductive cycle. These females were observed in the year between calving. In this alternate year, one was accompanied by a male escort and the other was observed in an active group of whales, fighting to become her escort.

Eleven additional females have produced calves at intervals no greater than two years. These females were not sighted in the alternate year between calving. It is unknown if they produced a calf in this alternate year.

Case histories of females known to have bred in consecutive years

Case 1: Whale 3208 has been photographed in seven different years, each year with a new calf. She was not seen in 1983, 1985 or 1987 and so it is unknown if she had a calf in any of these years. She produced five female calves (1979, 1981, 1982, 1984, 1988) and two males (1980, 1986).

During the nine years of observations she was sighted on twelve occasions, each time accompanied by a male escort, or an escort and several challengers. In 1988, she was first seen on 1 April with her calf accompanied by a male escort and a minimum of eight other whales battling to displace him. Whale 6010 succeeded, and became her new escort. This whale had been previously sighted in two other years, each time as an escort to other females. Thirteen days later on 14 April, we sighted whale 3208 and her calf slowly travelling to an area where she stopped to rest. She was accompanied by a new male escort, whale 11408. This male had not been present on 1 April, but had been sighted in 1987 with another mother and calf.

Case 2: Whale 2210, easily recognised by a distinctive white scarring pattern on her black flippers, produced calves two years in succession in 1980 and 1981, and again in 1987 and 1988. She was also seen with a calf in 1978 and 1985.

Case 3: Whale 1205 was first observed with a calf in 1977. We did not see her again until five years later in 1982, at which time she again had a calf. We next observed her four years later in 1986 with a calf and in the following year, 1987, with another calf.

Case 4: Whale 4201 was observed in only two years, 1981 and 1982, each year with a new calf.

Sex ratio of calves

During the 1977-85 period, we were able to determine the sex of 87 calves, 52.9% (46) were males and 47.1% (41) were females. This figure corresponds very closely to that obtained by Glockner (1983) through totalling 2,128 foetuses examined by Chittleborough (1958) in Australia, Omura (1953) in the Antarctic, and Matthews (1937) in South Georgia and Natal; 52.1% of the foetuses were male, 47.9% were females. Of 50 calves observed *in situ* in the North Atlantic in Massachusetts Bay, 56% were males, 44% were female (Clapham and Mayo, 1987b).

Growth of a calf to maturity

We initially photographed whale 2206C8 as a calf on 27 February 1978. This male calf had a distinctive v-shaped cut on the dorsal ridge of its peduncle, posterior to the dorsal fin. Six years later, in February 1984, we photographed a whale with a similar v-shaped cut in an active group of whales. It appeared smaller than the other animals, and usually surfaced on the periphery of the group. We obtained surface photographs of its fin and v-shaped cut. The following year, on 27 April, we resighted this whale and photographed it from both above and below the surface of the water. It was a male with three lip grooves on the right side of its lower jaw and the same pattern as calf 2206C8. These characteristics, along with the shape of its dorsal fin and v-shaped cut, lead us to believe that this individual is indeed whale 2206C8.

Assuming this is correct, whale 2206C8 was observed headlunging in an active group trio, while escorting a female, at seven years of age. Headlunging behavior in active groups is usually performed by the dominant male escort (Glockner-Ferrari and Ferrari, 1985; Tyack and Whitehead, 1983; Baker and Herman, 1984). Although it is difficult to determine if a male humpback has reached maturity, the behavior and role of whale 2206C8 as a dominant escort would indicate that he was most likely sexually mature by age seven. This would support Chittleborough's (1959; 1965) age determination data.

Whale 2206C8 was most recently observed on 14 April 1988, alone. He still appeared small. At ten years of age and presumably still not physically mature, he was singing.

Observations of resighted females without calves

Only three known females that have been observed in more than one year have never been seen with a calf. Two of the three were apparent subadults. Female 2218C8 was sighted as a calf and as a yearling accompanied by her mother. The other, female 9301, was assumed to be a juvenile at her initial sighting as she appeared small in size relative to an adult companion. Whale 9301 was resighted the year following her initial sighting.

The third female, whale 11234, was initially sighted in 1986 accompanied by an active group of whales. Glockner-Ferrari and Ferrari (1985) have demonstrated that the occurrence of active groups leads to pair formation and eventually mating. She was seen the following year with a male escort, but not with a calf, as might have been expected if her presence in the active group the previous year had resulted in copulation and successful conception. She was resighted three times in 1988, again without a calf; once accompanied by an active group of males and twice by a single male escort.

There are several possible reasons why whale 11234 may have not produced a calf by 1988. Clapham and Mayo (1987a) reported that North Atlantic females attained sexual maturity at no later than four and six years of age; we do not know the age of whale 11234 and so perhaps she was sexually immature in 1986 and 1987.

Lockyer (1984) reported the occurrence of aberrations in the fetuses of nearly all Mysticetes and mentions the rare occurrence of hermaphrodite whales, and so whale 11234 may be hermaphroditic or have other sexual dysfunctions. A close examination of photographs of her genital region revealed the presence of a hemispherical lobe, found only in females. However, the genital slit appeared to be situated in the position normal for males. The photographs also revealed an unusual occurrence of protrusions along the genital wall.

Her pigmentation pattern was also uncommon. The underside of the throat grooves and abdomen were extensively white and the white pigmentation extended upwards along the flanks. This pattern was classified as 'type 2' by Lillie (1915) for Southern Hemisphere humpbacks. Nishiwaki (1959) found that in the North Pacific, only 1.4% of humpback whales taken in Ryukyuan waters had this pigmentation pattern. We previously reported observing only one other whale with this type of pigmentation (Glockner and Venus, 1983; Glockner-Ferrari and Ferrari, 1984; 1985). Observations of whale 11234 in future years may reveal if it is capable of normal reproduction.

Distribution of mothers and calves

Distance from shore

During the period 1977-79, Glockner and Venus (1983) reported that the majority of mothers and calves sighted were found resting in shallow waters, often just beyond the surfline within the ten-fathom curve, a distance of approximately 0.4km from shore. Glockner-Ferrari and Ferrari (1985) analysed the numbers of mother-calf sets that were sighted and found a sharp decline in the percentage of mothers and calves photographed in these nearshore waters since the 1977-79 period. In the present study, we have reanalysed the data and included the total number of sightings. We again found a significant decrease in the numbers and percentage of mother-calf sightings in nearshore waters following the 1977-79 period (Fig. 2).

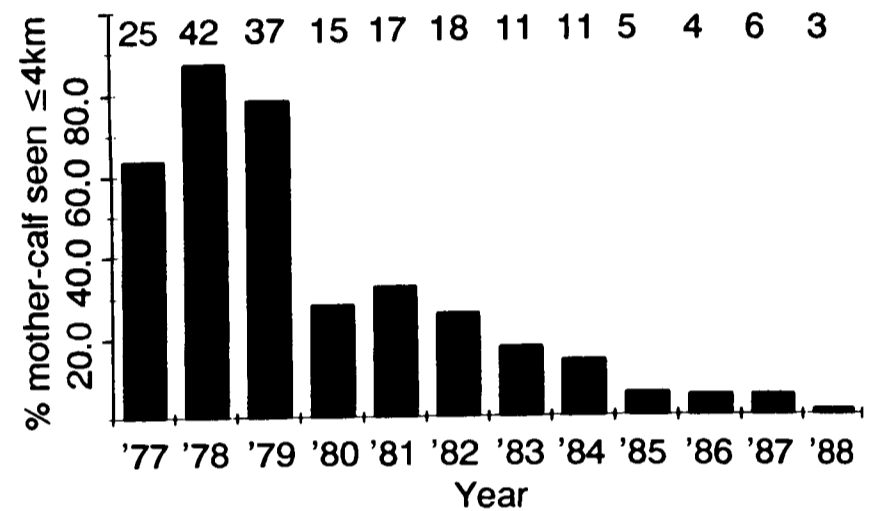

Fig. 2. Distribution of mothers and calves in nearshore waters off West Maui, 1977-88. Sample size (along the top), is the number of mother-calf sets sighted each year within 0.4km of shore.

In 1980, only 28.3% (15 of 53 sightings) of mother-calf sets were observed within 0.4km of shore. During that year, agricultural runoff from heavy winter storms created a dense mudline in nearshore waters, which the whales seemed to avoid (Glockner-Ferrari and Ferrari, 1985). However, in 1981, the percentage of sightings of mothers and calves in nearshore waters remained low and it has continued to decrease each year thereafter. By 1988, only 1.5% (3 of 203 sightings) of mothers and calves were observed in waters within 0.4km of shore (Table 5).

Table 5

Percentage of mothers and calves sighted in nearshore waters off West Maui, 1977-88.

Year	Total			Within 0.4km of shore		
	hr	M-C	%S/hr	M-C	%S/hr	%M-C/hr
1977	174	39	22.4	25	14.4	64.1
1978	150	48	32.0	42	28.0	87.5
1979	134	47	35.1	37	27.6	78.7
1980	291	53	18.2	15	5.2	28.3
1981	228	52	22.8	17	7.5	32.7
1982	251	69	27.3	18	7.2	26.1
1983	233	63	27.0	11	4.7	17.5
1984	283	78	27.6	11	3.9	14.1
1985	282	88	31.2	5	1.8	5.7
1986	307	79	25.7	4	1.3	5.1
1987	339	117	34.5	6	1.8	5.1
1988	395	203	51.4	3	0.8	1.5

hr=no. of ocean hrs of observation; M-C=no. of mother-calf sightings; %S[M-C]/hr=%sightings [mother-calf sightings] per hr of observation

DISCUSSION

Identification

The use of photographic techniques in our long-term study of humpback whales has proven extremely effective in identifying individual whales, compiling their life histories, and understanding their behavior, social roles and reproductive cycle. The use of underwater photography has enabled us to record several morphological characteristics, including the sex, to confirm the identification of an individual whale, and thus increase our ability to reconfirm its identification at a later sighting. The combined use of both surface and underwater photography has increased the number of individual whales we were able to identify. Conducting the study annually over a long-term period has enabled us to successfully compile resighting histories for 69 individuals.

Reproductive cycle

From an analysis of ovary and mammary gland data from humpback whales taken by the whaling industry in the South Indian Ocean, Matthews (1937) suggested that the majority of females breed once every two years and a minority breed twice every three years. From similar data from Western Australian whaling stations, Chittleborough (1958) reported that the majority of females breed once every two years, stating that postpartum ovulation with conception is probably not frequent in this species.

Our 1975–88 benign study has shown that known females produced calves at both one and two year intervals. Maximum calving intervals ranged from one to nine years. However, an unexpectedly high percentage of one year calving intervals was observed; 14% (7 of 50 calving intervals) were one year, 34% (17 of 50 maximum calving intervals) were no greater than 2 years. Since our resighting histories of known females are not always continuous, a one year calving interval probably occurs at an even greater frequency than demonstrated.

In the North Atlantic, Clapham and Mayo (1987b) reported a mean calving interval for humpback whales observed in Massachusetts Bay of 2.4 years. Only 3.5% (1 of 28) of their observed calving intervals were one year.

Frequent occurrence of a one year reproductive cycle in females sighted in Hawaiian waters could indicate that the population is increasing. However, the recruitment rate of a population is dependent not only on the reproductive rate, but also on the survival rate of the calves and the age at which they reach sexual maturity (Allen, 1974). A one year reproductive cycle in which postpartum ovulation occurs with conception might be the result of the loss of a calf.

Herman and Antinaja (1977) reported that only 9.1% and 9.6% of the whales they observed in 1976 during aerial surveys of Hawaiian waters were calves, and suggested that the birth rate for the population was low. Baker *et al.*, (1987) estimated a calving rate of 0.58 for females in Hawaiian waters but suggested that it was inflated by sighting biases. They estimated a rate of 0.37 for females sighted in Alaskan waters, or a calving interval of 2.7 years for females whose calves have survived their first six months of life.

Unless a calf is resighted with its mother, reconfirming its identification in following years is difficult because its pigment patterns darken with age (Glockner and Venus, 1983; Carlson, Mayo and Whitehead, 1990). Thus far, we have confirmed the identification of only three calves in

years subsequent to their birth. As yet, we have not been able to confirm the identification in a subsequent year of any of the calves produced on a one year reproductive cycle. The appearance and behavior of each of the seven calves produced by whale 3208 suggested that they were normal, healthy individuals, often exhibiting very playful behavior. Present work comparing photographs of known mothers identified on the winter grounds with those seen on the summer feeding grounds could lead to vital information on calf survivorship (IWC, 1989 pp.110, 116).

Distribution

Our 1977–88 distribution data demonstrated a decline in the numbers of mothers and calves inhabiting nearshore waters off the west coast of Maui. During this same time, an increase has occurred in vessel traffic and high-speed 'thrill craft' operations, such as parasailing and jet ski activities, in these same nearshore waters (Glockner-Ferrari and Ferrari, 1985).

During 1987, Glockner-Ferrari, Ferrari, and McSweeney (1987) reported an increase in the numbers of sick, injured, and stranded calves and juveniles in Hawaiian waters. Baker, Herman, Bays and Bauer, (1983) reported a significant change in respiratory behavior of humpback whales in response to vessel proximity and speed. Bauer and Herman (1986), found that vessels can significantly affect whale behavior from as far away as 500m to 1000m.

Increase in human activities in nearshore waters may be adversely affecting the distribution and behavior of mothers and calves, which could possibly result in a decrease in the survival rate of calves and the rate of recruitment to the mature population. Continued monitoring of the population on its breeding grounds in Hawaiian waters is essential. Use and further development of benign techniques to provide information that will aid in management decisions to ensure the survival of the species is necessary. Future studies should be directed towards determining the survival rates of calves and their recruitment rate to the mature population and towards determining the causes of any adverse effects upon the population.

ACKNOWLEDGEMENTS

We would like to express our sincerest thanks to Wildlife Conservation International of the New York Zoological Society and Hawaiian Airlines, whose long-term support has enabled us to conduct our field studies. We would like to thank the National Marine Mammal Laboratory, the National Marine Fisheries Service Western Pacific Program Office and the Marine Mammal Commission for their assistance in the data analysis. We would also like to thank the American Cetacean Society, Los Angeles Chapter, the Connecticut Cetacean Society, the International Wildlife Coalition, World Wildlife Fund, the Cousteau Society, Whale-Aid Hawaii, and the San Francisco Examiner for their support. We are especially grateful to the International Whaling Commission for making it possible for us to attend the Symposium on the Use of Non-Lethal Techniques, Especially Photo-Identification Techniques, to Estimate Cetacean Population Parameters.

We would especially like to thank Dr. Roger Payne who inspired our study of living whales. We are especially grateful to Wilfred and Elrita Glockner who so generously

gave us their support from the very beginning. We would like to thank Harold, Dorothy, and Lisa Ferrari, Randy and Gail Puckett, Phil Clapham, Doris Lang, Gordon Firestein, Mike Phillips, John Altberg, Barry and Irene McPhee, Jane Rogers, Tom Layton, Evan and Mary Lloyd, Barbara Baciagalupi, Chuck and Connie Sutherland, Jim Luckey, Greg Johnston, Kieran Burke, Jim and Midge McGann, Pieter Folkens, Doug and Lori Wylie, Al Withnow, Alex Ortiz, Nancy and Hamilton Harris, Joe Brignole, Rocky Thies, and all the whalewatch captains and crew who gave us their support. We would like to thank the San Francisco Foundation, the Wallace Alexander Gerbode Foundation, Ocean Riders, Inc., Dolphin Galleries, American Hawaii Cruises, Nikon Professional Services, Kodak Professional Photography Division, SeaQuest Inc., Johnson Outboards, Alpha Photo, O'Neill Inc., Soarus Technologies, Maui Toyota, the Lahaina Restoration Foundation, Zodiac of North America, Globe Gears and Couplings, and Headquarters Company. We would like to thank all the members of Center for Whale Studies for generously giving us their support.

We would especially like to thank Sally Mizroch of the National Marine Mammal Laboratory for all of her advice and suggestions. We offer a very special thank you to Dr. Steven L. Swartz and James E. Scarff for so generously taking the time to review this manuscript and offer their suggestions.

REFERENCES

- Allen, K.R. 1974. Recruitment to whale stocks. pp. 352-358. In: Schevill, W.E. (ed.), *The Whale Problem: a Status Report*. Harvard University Press, Cambridge, 419pp.
- Allen, K.R. 1980. *Conservation and Management of Whales*. University of Washington, Seattle. 107pp.
- Baker, S.C. and Herman, L.H. 1981. Migration and local movement of humpback whales, *Megaptera novaeangliae*, through Hawaiian waters. *Can. J. Zool.* 59:460-69.
- Baker, S.C. and Herman, L.H. 1984. Aggressive behavior between humpback whales, *Megaptera novaeangliae*, wintering in Hawaiian waters. *Can. J. Zool.* 62:1922-37.
- Baker, S.C., Herman, L.H., Bays, B.G. and Bauer, G. 1983. The impact of vessel traffic on the behavior of humpback whales in Southeast Alaska: 1982 season. Contract Rep. NMFS National Marine Mammal Laboratory, Seattle.
- Baker, S.C., Herman, L.H., Perry, A., Lawton, W.S., Straley, J.M. and Straley, J.H. 1985. Population characteristics and migration of summer and late-season humpback whales (*Megaptera novaeangliae*) in Southeastern Alaska. *Mar. Mamm. Sci.* 1(4):304-23.
- Baker, S.C., Herman, L.H., Perry, A., Lawton, W.S., Straley, J.M., Wolman, A.A., Kaufman, G.D., Winn, H.E., Hall, J.D., Reinke, J.M. and Ostman, J. 1986. Migratory movement and population structure of humpback whales (*Megaptera novaeangliae*) in the Central and Eastern North Pacific. *Mar. Ecol. Prog. Ser.* 31:105-19.
- Baker, S.C., Perry, A. and Herman, L.H. 1987. Reproductive histories of female humpback whales *Megaptera novaeangliae* in the North Pacific. *Mar. Ecol. Prog. Ser.* 41:103-14.
- Balcomb, K.C. and Nichols, G. 1978. Western North Atlantic humpback whales. *Rep. int. Whal. Commn* 28:159-64.
- Bauer, G.B. and Herman, L.H. 1986. Effects of vessel traffic on the behavior of humpback whales in Hawaii. Contract Rep. NMFS Western Pacific Program Office, Honolulu.
- Carlson, C.A., Mayo, C.A. and Whitehead, H. 1990. Changes in the ventral fluke pattern of the humpback whale, *Megaptera novaeangliae*, and its affect on matching: evaluation of its significance to photo-identification research. Paper SC/A88/ID35 (published in this volume).
- Chittleborough, R.G. 1958. The breeding cycle of the female humpback whale, *Megaptera nodosa* (Bonnaterre). *Aust. J. Mar. Freshw. Res.* 6:3-29.
- Chittleborough, R.G. 1959. Determination of age in the humpback whale, *Megaptera nodosa* (Bonnaterre). *Aust. J. Mar. Freshw. Res.* 10:125-43.
- Chittleborough, R.G. 1965. Dynamics of two populations of the humpback whale, *Megaptera novaeangliae*, (Borowski). *Aust. J. Mar. Freshw. Res.* 16:33-128.
- Clapham, P.J. and Mayo, C.A. 1987a. The attainment of sexual maturity in two female humpback whales. *Mar. Mamm. Sci.* 3(3):279-83.
- Clapham, P.J. and Mayo, C.A. 1987b. Reproduction and recruitment of individually identified humpback whales, *Megaptera novaeangliae*, observed in Massachusetts Bay, 1979-1985. *Can. J. Zool.* 65:2853-2863.
- Cabbage, J.C., Calambokidis, J., Stieger, G.H., Balcomb, K.B. and Bloedel, P. 1990. Photo-identification of humpback whales, *Megaptera novaeangliae*, in the Gulf of the Farallones, California, with an analysis of potential sources of sample bias. Paper SC/A88/ID36 (published in this volume).
- Darling, J.D., Gibson, K.M. and Silber, G.J. 1983. Observation on the abundance and behavior of humpback whales, *Megaptera novaeangliae*, off West Maui, Hawaii, 1977-79. pp. 210-22. In: R. Payne (ed.) *Communication and Behavior of Whales* AAAS Selected Symposia Series. Westview Press, Boulder. 643pp.
- Darling, J.D. and Jurasz, C.M. 1983. Migratory destinations of North Pacific humpback whales, *Megaptera novaeangliae* pp. 359-68. In: R. Payne (ed.) *Communication and Behavior of Whales* AAAS Selected Symposia Series. Westview Press, Boulder. 643pp.
- Darling, J.D. and McSweeney, D.J. 1985. Observation on the migration of North Pacific humpback whales (*Megaptera novaeangliae*) *Can. J. Zool.* 63:308-14.
- Darling, J.D. and Morowitz, H. 1986. Census of "Hawaiian" humpback whales (*Megaptera novaeangliae*) by individual identification. *Can. J. Zool.* 64:105-11.
- Dawbin, W.H. 1966. The seasonal migratory cycle of humpback whales. pp. 145-70. In: K. Norris (ed.) *Whales, Dolphins, and Porpoises*. University of California Press, Berkeley. 789pp.
- Flores, C.M. 1987. Fotoidentificacion Del Rocual Jorobado, *Megaptera novaeangliae* (Borowski, 1781), En Las Aguas Adyacentes a Isla Isable, Nay. (Cetacea: *Balaenopteridae*). Tesis Profesional. Universidad Nacional Autonoma de Mexico. 107pp.
- Gambell, R. 1976. World whale stocks. *Mammal Rev.* 6(1):41-53.
- Glockner, D.A. 1978. The humpback whale, *Megaptera novaeangliae*, Underwater with mothers and calves. *Waters: (J. Vancouver Aquar.)* 3:19-25.
- Glockner, D.A. 1983. Determining the sex of humpback whales, *Megaptera novaeangliae*, in their natural environment. pp. 447-64. In: R. Payne (ed.) *Communication and Behavior of Whales* AAAS Selected Symposia Series, Westview Press, Boulder. 643pp.
- Glockner, D.A. and Venus, S.C. 1983. Identification, growth rate, and behavior of humpback whale, *Megaptera novaeangliae*, cows and calves in the waters off Maui, Hawaii, 1977-79. pp. 223-58. In: R. Payne (ed.) *Communication and Behavior of Whales* AAAS Selected Symposia Series, Westview Press, Boulder. 643pp.
- Glockner-Ferrari, D.A. 1982. Photographic identification of humpback whales, *Megaptera novaeangliae*. *Whalewatcher: (J. Amer. Cet. Soc.)* 16:9-11.
- Glockner-Ferrari, D.A. and Ferrari, M.J. 1984. Reproduction in humpback whales, *Megaptera novaeangliae*, in Hawaiian waters. *Rep. int. Whal. Commn* (special issue 6): 237-42.
- Glockner-Ferrari, D.A. and Ferrari, M.J. 1985. Individual identification, behavior, reproduction, and distribution of humpback whales, *Megaptera novaeangliae* in Hawaii. *Rep. Mar. Mamm. Commn.* NTIS PB85-200772. 36pp.
- Glockner-Ferrari, D.A. and Ferrari, M.J. 1987. Identification, Reproduction, and Distribution of Humpback Whales in Hawaiian Waters, 1984 and 1985. Contract Rep., NMFS National Marine Mammal Lab, Seattle. 33pp.
- Glockner-Ferrari, D.A., Ferrari, M.J. and McSweeney, D.J. 1987. Occurrence of abnormalities, injuries and strandings of humpback whales in Hawaiian waters. Presented to the Seventh Conference on the Biology of Marine Mammals, Miami, December 1987 (unpublished).
- Herman, L.M. and Antinaja, R.C. 1977. Humpback whales in the Hawaiian breeding waters: Population and pod characteristics. *Sci. Rep. Whales Res. Inst., Tokyo* 29:59-85.
- International Whaling Commission. 1989. Report of the Scientific Committee. *Rep. int. Whal. Commn* 39:33-64.
- Jurasz, C.M. and Jurasz, V.P. 1978. Humpback whales in Southeastern Alaska. *Alaska Geo.* 5(4):116-27.

- Katona, S., Baxter, S., Brazer, O., Kraus, S., Perkins, J. and Whitehead, H. 1979. Identification of humpback whales by fluke photographs. In: H.E. Winn and B.L. Olla (eds.) *Behavior of Marine Animals – Current Perspectives in Research, Vol. 3 Cetaceans*. Plenum Press, New York.
- Kraus, S. and Katona, S. 1977. *Humpback Whales in the Western North Atlantic – A Catalogue of Identified Individuals*. College of the Atlantic, Bar Harbor, Maine. 26pp.
- Lillie, D.G. 1915. Cetacea. British Antarctic (Terra Nova) Expedition, 1910. *Natl. History Rep., Zool.* 1:85–124.
- Lockyer, C. 1984. Review of baleen whale (Mysticeti) reproduction and implications for management. *Rep. int. Whal. Commn* (special issue 6):27–50.
- Matthews, L.H. 1937. The humpback whale, *Megaptera nodosa*. *Discovery Rep.* 17:7–92 + 1 plate.
- Mizroch, S., Beard, J. and Lynde, M. 1990. Computer assisted photo-identification of humpback whales. Paper SC/A88/ID11 (published in this volume).
- Mobley, Jr., J.R. and Herman, L.H. 1985. Transience of social affiliations among humpback whales (*Megaptera novaeangliae*) on the Hawaiian wintering grounds. *Can. J. Zool.* 63:762–72.
- Nishiwaki, M. 1959. Humpback whales in Ryukyuan waters. *Sci. Rep. Whales Res. Inst., Tokyo* 14:49–87.
- Omura, H. 1953. Biological study on humpback whales in the Antarctic whaling Areas IV and V. *Sci. Rep. Whales Res. Inst.* 8:81–102.
- Payne, K., Tyack, P. and Payne, R. 1983. Progressive changes in the songs of humpback whales, (*Megaptera novaeangliae*): A detailed analysis of two seasons in Hawaii. pp. 9–57. In: R. Payne (ed.) *Communication and Behavior of Whales*. AAAS Symposia Series, Westview Press, Boulder. 643pp.
- Payne, R. 1982. New light on singing whales. *Nat. Geog.* 161:463–77.
- Rice, D.W. 1974. Whales and whale research in the eastern North Pacific. pp. 170–95. In: W.E. Schevill (ed.) *The Whale Problem: A Status Report*. Harvard University Press, Cambridge. 419pp.
- Rice, D.W. 1978. The humpback whale in the North Pacific: Distribution, exploitation and numbers. pp. 29–44. In K.S. Norris and R.R. Reeves (eds.) Report on a Workshop on Problems related to Humpback Whales, (*Megaptera novaeangliae*), in Hawaii. Final Rep. U.S. Mar. Mam. Commn. U.S. Dept. Commer., NTIS PB-280–274. 90pp.
- Rice, D.W. and Wolman, A.A. 1978. Humpback whale census in Hawaiian waters – February 1977. pp. 45–53. In K.S. Norris and R.R. Reeves (eds.) Report on a Workshop on problems related to humpback whales, (*Megaptera novaeangliae*), in Hawaii. Final Rep. U.S. Mar. Mam. Commn. U.S. Dept. Commer., NTIS PB-280–794. 90pp.
- Silber, G.K. 1986. Non-song Phonations and Associated Surface Behavior of the Hawaiian Humpback Whales, *Megaptera novaeangliae*. Thesis. San Jose State University. 58pp.
- Straley, J.M. 1990. Fall and winter occurrence of humpback whales, *Megaptera novaeangliae*, in southeastern Alaska. Paper SC/A88/ID26 (published in this volume).
- Tyack, P. 1981. Interactions between singing Hawaiian humpback whales and conspecifics nearby. *Behav. Ecol. Sociobiol.* 8:105–16.
- Tyack, P. and Whitehead, H. 1983. Male competition in large groups of wintering humpback whales. *Behavior.* 83:132–154.
- Urban, J.R. and Aguayo, A.L. 1987. Spatial and seasonal distribution of the humpback whale, *Megaptera novaeangliae*, in the Mexican Pacific. *Mar. Mamm. Sci.* 3(4):333–44.
- von Ziegesar, O. and Matkin, C.O. 1985. A catalogue of humpback whales in Prince William Sound, Alaska, identified by fluke photographs between the years 1977 and 1984. Contract Rep. No. 41 USC 252. NMFS National Marine Mammal Lab, Seattle.
- von Ziegesar, O. and Matkin, C.O. 1986. Humpback Whales in Prince William Sound in 1985. Contract Rep. No. 41 USC 252. NMFS National Marine Mammal Lab, Seattle.
- Wolman, A.A. and Jurasz, C.M. 1977. Humpback whales in Hawaii: Vessel census, 1976. *Mar. Fish. Rev.* 39:1–5.

Reproduction of Humpback Whales (*Megaptera novaeangliae*) Observed in the Gulf of Maine

Phillip J. Clapham and Charles A. Mayo

Cetacean Research Program, Center for Coastal Studies, PO Box 1036, Provincetown, Mass. 02657, USA

ABSTRACT

A high level of effort in the Gulf of Maine between the years 1979 and 1987 has produced detailed resighting histories of individual humpback whales, *Megaptera novaeangliae*, allowing us to conduct a study of reproduction in this population. The crude birth rate during this period ranged from 0.045 to 0.103 (mean=0.079), with no significant year-to-year variation. An alternative measure gave a mean reproductive rate of 0.41 calves per mature female per year. Sixty-five females were observed with a total of 120 calves. Thirty-one females were observed with more than one calf during the study. Observed calving intervals were: 1 year (n=2), 2 years (n=36), 3 years (n=14), 4 years (n=2) and 5 years (n=1); 52 of the 55 intervals involved complete resighting histories between years of known calving. Five calves born during the study period were observed with calves of their own in later years. Data from these whales, and from other mothers whose age can be estimated, suggest that the majority of females attain sexual maturity by the age of six. Of 94 calves born prior to 1987, 72 (76.6%) were resighted in at least one year after separation from their mothers, providing further support for the belief that the composition of a humpback whale feeding stock is determined matrilineally. Eleven of a possible 13 calves were observed to the age of 6 years and may therefore have survived to breeding age. Two others were probably lost to entanglements in commercial fishing gear, which may represent a significant source of mortality in this population. The value of using variation in the shape, size and scarring of the dorsal fin to identify individuals is discussed.

INTRODUCTION

Long-term studies based upon the identification of individual animals can be well-suited to investigations of the reproductive biology of a species. This is particularly true of the humpback whale (*Megaptera novaeangliae*), a migratory species which returns every spring from tropical calving grounds to specific high-latitude feeding areas (Baker, Herman, Perry, Lawton, Straley and Straley, 1985; Clapham and Mayo, 1987a). In the Gulf of Maine, this characteristic of regional fidelity, combined with intensive survey effort over the last decade, has allowed us to construct detailed resighting histories of many individual whales, thus facilitating a variety of long-term studies.

Clapham and Mayo (1987a) summarised observations of the reproduction and recruitment of individually-identified humpback whales from the Gulf of Maine population, made between the years 1979 and 1985. In this paper, those data are combined with data from 1986 and 1987. We also summarise information on the age at attainment of sexual maturity of female humpback whales from the region.

METHODS

The data analysed here came from a total of 5,979 cruises made between 1979 and 1987. The majority (97.3%) of these were four-hour cruises made by 30m commercial whalewatching vessels operating daily from Provincetown, Massachusetts between April and October each year. Additional cruises of varying duration were made year-round using the 12m diesel-powered research vessel *Halos* or the 14m auxiliary ketch R/V *Sirius*. The majority of observations were made in the region of Massachusetts Bay, an area that includes Stellwagen Bank and Cape Cod Bay (Fig. 1). Beginning in 1984, additional data were gathered during occasional cruises to other locations in the southern Gulf of Maine; these included the Provincetown Slope (the region of sloping bottom east of Cape Cod, Massachusetts) and the Great South Channel (41°00'N,

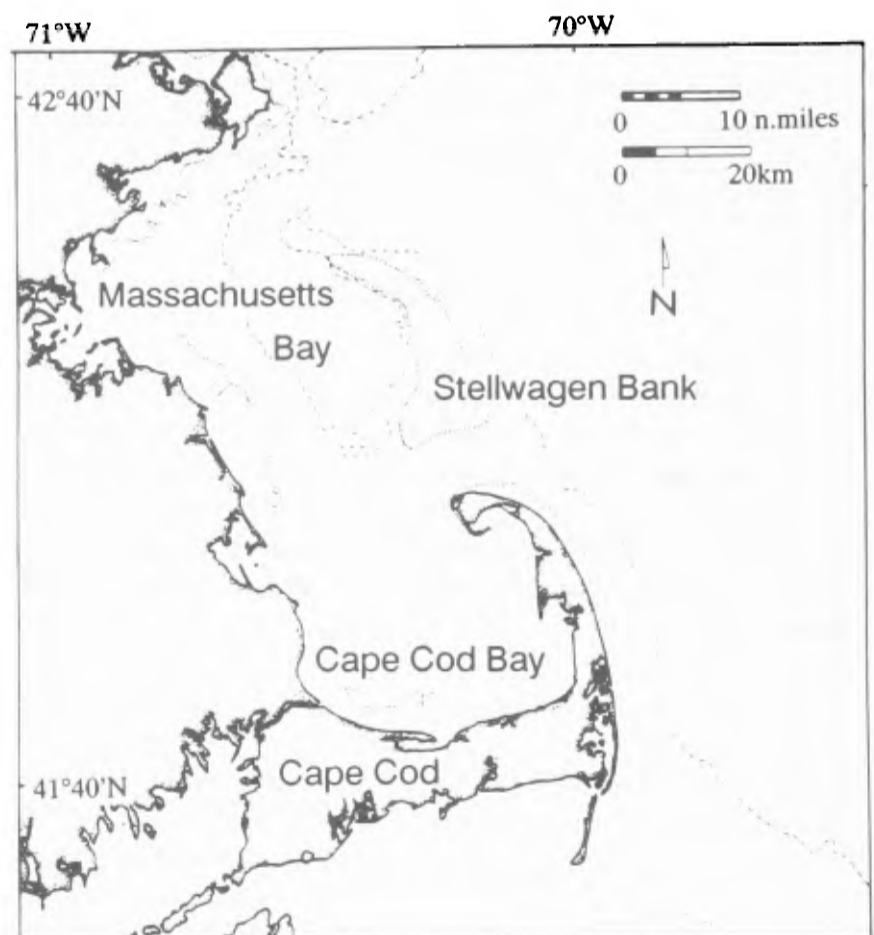

Fig. 1. Main study area.

69°10'W). Details of general effort and of the Massachusetts Bay study area are given in Clapham and Mayo (1987a).

Whales were photographed using a 35mm camera equipped with a 200mm, 300mm or 400mm lens, power winder and databack; black and white film rated at ISO 400 was used. Individual whales were identified from variations in ventral fluke pattern (Katona, Harcourt, Perkins and Kraus, 1980), and variation in the shape, size and scarring of the dorsal fin (Mayo, 1982). This latter method was particularly useful in completing sighting histories where fluke photographs were not available.

Each whale was given a name (based upon distinctive markings), and was assigned a catalogue number by the North Atlantic Humpback Whale Catalogue at the College of the Atlantic, Bar Harbor, Maine (Katona *et al.*, 1980). Only sightings documented with photographs were used in this report.

Reproductive rates

(i) *Crude birth rate* is defined here as T_c/T_i , where T_c is the total number of calves observed in a given year, and T_i is the total number of individual whales of all classes (including calves) observed in the same year. Only individuals observed by us in our study area were included in the calculations; sightings in the Gulf of Maine by other observers were not included. However, sightings of known whales observed by colleagues were used to fill gaps in individual resighting histories to permit a more complete assessment of the other two measures of reproduction.

(ii) *Calves per mature female per year* was calculated by dividing the number of calves observed in a year by the number of known mature females observed in that year. In order to include only mature animals in this calculation, we have excluded observations of females in years prior to the year of their first known pregnancy.

(iii) *Calving interval* is the interval, in years, between successive calves of an individually-identified female.

(iv) *Age at first reproduction* is, for the purposes of this study, the age at which a known female is observed with her first calf in our study area; it is possible that a female may have previously given birth but lost her calf prior to reaching the study area. Assuming a 12 month gestation period (Lockyer, 1984), the *age at attainment of sexual maturity* is assumed to be one year less.

RESULTS

Reproductive rates

From 1979 to 1987, we observed 65 individually-identified mature females with a total of 120 calves. The observed crude birth rate (Table 1) varied from a low of 0.045 in 1981 to a high of 0.103 in 1983. The mean of the nine annual values was 0.079 (SD=0.020), with no significant year-to-year differences observed (chi-square=4.067, df=8).

Table 1

Number of individuals observed (T_i), number of calves observed (T_c) and crude birth rate (T_c/T_i) for the period 1979–1987.

Year	T_i	T_c	T_c/T_i	Year	T_i	T_c	T_c/T_i
1979	51	5	0.098	1984	195	12	0.062
1980	60	4	0.067	1985	230	20	0.087
1981	89	4	0.045	1986	224	20	0.089
1982	138	9	0.065	1987	216	21	0.097
1983	116	12	0.103				

Table 2

Number of calves per mature female per year during the study period (mean=0.41, SD=0.078).

Year	1979	1980	1981	1982	1983	1984	1985	1986	1987
Rate	0.50	0.40	0.24	0.38	0.45	0.36	0.45	0.39	0.48

	1979	1980	1981	1982	1983	1984	1985	1986	1987
EQUUS	●	○	●	○		●		○	
FEATHER	●	○	●	○	○			●	○
FRINGE	●	○	○	●	○	●	○	●	
ISTAR	●	○	●	○	○	●	○	●	○
PEGASUS	●	○	○	●	○	○	●	○	●
FALCO	○	●	○	○	○	●	○	●	○
NURSE	○	●	○	○	●	○	●	○	○
SALT	○	●	○	○	●	○	●	○	●
SILVER	○	●	○	○	●	○	●	○	○
SINISTRA	○	○	●	○	●	○	○	●	○
CARDHU			○	●	○	○	●	○	●
CAT'S PAW			○	●	○	●	○	○	○
FLAG			○	●		○	●	○	●
JANUS			○	●	○	●	○	●	○
MARS	○	○	○	●	○	●	●	○	●
PEPPER		○	○	●	○	○	○	●	○
TRINE			○	●	○	●	○	●	
EBONY			○	○	●	○	○	●	●
FIVE-J		○	○	○	●	○	○	●	○
IVORY	○	○	○	○	●	○	●	○	●
OLYMPIA	○	○	○	○	●	○	●	○	●
RUNE		○	○	○	●	○	●	○	○
VEIL			○	○	●	○	●	○	●
WARRIOR	○	○		○	○	●	○	●	○
ORBIT	○	○	○	○	○	●	○	●	○
HORIZON			○			●	○	○	●
ARROW		○	○	○	○	○	●	○	●
POINT	○	○	○	○	○	○	●	○	●
SERGEANT				○	○	○	●	○	●
ALTIP	○	○	○	○	○	○	●	○	●
SOD	○	○	○	○	○	○	●	○	●

○ OBSERVED
● OBSERVED WITH FIRST-YEAR CALF

Fig. 2. Sighting and reproductive histories of female humpbacks observed with more than one calf during the study period.

An analysis of the resighting and reproductive histories of individual females yielded an annual reproductive rate of from 0.24 to 0.5 calves per mature female per year (Table 2).

Thirty-one mature females were observed to give birth to more than one calf during the study period, providing information on a total of 55 calving intervals (Fig. 2). The observed intervals were: 1 year (n=2), 2 years (n=36), 3 years (n=14), 4 years (n=2) and 5 years (n=1). The mean interval was 2.35 years (SD=0.70). Three of the 55 intervals involved resighting histories which were incomplete between years of known calving (two intervals of 3 years and one interval of 5 years). The resighting histories of females who were observed with only one calf during this study are shown in Fig. 3.

Attainment of sexual maturity in females

Table 3 summarises the resighting and reproductive histories of the individual females discussed in this section. Between 1985 and 1987, five known age females returned to the study area with their first observed calves; two of

Table 3

Resighting and reproductive histories of female humpbacks who attained sexual maturity during this study.

Name	Cat.#	First seen	Year born	First calf	Age at sexual maturity (y)
Beltane	0214	1980	1980	1985	not more than 4
Ibis	0215	1979	1979	1986	not more than 6
Talon	0305	1981	1981	1987	not more than 5
Scylla	0331	1981	1981	1987	not more than 5
Streamer	0323	1982	1982	1987	not more than 4
Orbit	0167	1979	?	1984	minimum of 5
Lightning	0236	1978	?	1985	minimum of 7
Altiplana	0272	1979	?	1985	minimum of 6
Sod	0163	1979	?	1985	minimum of 6
Point	0231	1979	?	1985	minimum of 6
Midnight	0199	1979	?	1986	minimum of 7
Scratch	0148	1979	?	1986	minimum of 7
Liner	0263	1981	?	1986	minimum of 5

	1979	1980	1981	1982	1983	1984	1985	1986	1987
SPOON	○	○	○	○	●	○	○	○	○
EIDER					●	○			
SOLO					●				
BINOC		○	○	○	○	●	○	○	
COLUMBIA		○	○	○	○	●	○	○	○
ABRAXUS	○	○	○	○	○	○	○	○	○
LIGHTNING	○	○	○	○	○	○	●		○
CIRRUS			○	○		○	●	○	○
BELTANE		⊗	○	○	○	○	○	○	○
SCRATCH	○	○	○	○	○	○	○	○	○
BUCKSHOT	○		○	○		○	○	○	○
IBIS	⊗	○	○	○	○	○	○	○	○
LINER			○	○	○	○	○	○	○
LYNX				○				○	○
MIDNIGHT	○	○	○	○	○	○	○	○	○
MOTH					○	○	○	○	○
NEBULA				○				○	
PETREL								○	○
PHOENIX				○			○	○	○
SICKLE	○		○	○	○	○	○	○	○
SCYLLA			⊗	○	○	○	○	○	○
TALON			⊗	○	○	○	○	○	○
TRIDENT				⊗	○	○	○	○	○
LACE		○		○	○	○	○		○
LOON							○	○	○
STAFF						○		○	○
STAR				○	○		○	○	○
W						○			○
NIMBUS							○	○	○
GLO						○	○	○	○
MICA						○			○

○ OBSERVED
● OBSERVED WITH CALF
⊗ YEAR OF BIRTH

Fig. 3. Sighting and reproductive histories of female humpbacks observed with only one calf during the study period.

these were reported by Clapham and Mayo (1987b). All five mothers had been observed as first-year calves in previous years, and all were resighted repeatedly every year thereafter.

The average age at attainment of sexual maturity (ASM) of the thirteen female humpback whales in Table 3 was 5.54 years. However, as eight of the figures given above are minimum values, it is likely that the true mean age at sexual maturity of these whales is greater than this.

Return and recruitment of calves

Of the 94 calves born prior to 1987, 72 (76.6%) were observed to return to the area in at least one year after separation from their mothers. One calf born in 1986 was still associated with its mother in 1987.

For this report, we have assumed that the ASM in humpback whales is 6 years. This is based upon data from Table 3 and on the assumption that males and females reach maturity within the same range of ages (Chittleborough, 1965; Lockyer, 1984). If this is correct, calves born prior to 1982 would have reached maturity by the last year of the study period. Of the 13 whales in this category, 11 (84.6%) were observed to the age of at least 6

years. Two others were known to have been involved in entanglements in commercial fishing gear (one at age 2, the other at age 4) and may not have survived.

DISCUSSION

Reproductive rates

This population has apparently been relatively stable in terms of both crude birth rate and in calves per mature female per year, with no marked year-to-year differences. The range of rates is broadly similar to that reported for humpback whales elsewhere (Chittleborough, 1965; Herman and Antinoya, 1977; Whitehead, 1982; Baker, Perry and Herman, 1987).

Our sample size of calving intervals is now sufficiently large, and the resighting histories that accompany them sufficiently complete, to permit us to assess with some confidence the calving interval. Clearly, females reproduce most commonly every two years; this concurs with the results of other long-term studies (Glockner-Ferrari and Ferrari, 1990; Baker *et al.*, 1987) and with whaling catch data (e.g. Matthews, 1937; Chittleborough, 1965). If we assume that some calves die prior to arrival in our study area, the observed mean calving interval of 2.35 years can be regarded as a somewhat conservative estimate of this measure of reproduction. The observation of a single five-year interval may be misleading, since the individual in question was not observed for two years between its years of known calving. Given the pattern observed in other females, it is likely that this whale gave birth to a calf in the intervening years, which would result in two intervals of two and three years instead of a single interval of five. However, another whale with a more complete resighting history was resighted every year for four years after her first calf, with no second calf observed. This may represent a longer calving interval than the average; alternatively, a calf might have been born but not have survived.

In late 1987 and early 1988, a mass mortality of humpbacks occurred in this area: fifteen individuals (including a number of those included in this report) are known to have died during a period of seven weeks, and it is likely that the actual death toll was much higher. The cause appears to have been saxitoxin poisoning associated with ingestion of mackerel (*Scomber scombrus*) (Geraci,

Anderson, Timperi, St. Aubin, Early, Prescott and Mayo, 1989). The effect that this mortality will have on this population's future dynamics is unknown. However, if sampling effort remains high, analyses to estimate survivorship for each year (Buckland, 1990) will enable mortality for 1987/88 to be estimated.

Attainment of sexual maturity in females

A number of observers have used data from whaling operations to estimate the average age at sexual maturity (ASM) in female humpback whales. Examination of the ovaries together with an age estimate derived from earplug growth layer groups (GLGs; one dark and one pale lamina), provides a range of calculated values. For such studies the ASM is in fact the mean age at first ovulation; it is not always possible to determine if conception and successful calving took place. For this reason one might expect ASMs using this method to be lower than those from photo-identification data. Late-maturing animals may be under-represented using either method. However, estimates of ASM from ovary/earplug data depend critically on knowing the number of GLGs laid down annually in the earplug. Chittleborough (1959; 1960; 1965) believed that two GLGs were laid down each year; from this, and from examination of 1,603 females, he estimated that most (70%) females attained sexual maturity at four or five years of age. Using the same criteria, Nishiwaki (1959) obtained a value of five years for 108 females taken off the Ryukyu Islands in the North Pacific. However, by comparison with species such as the fin whale, for which better calibration data are available, most researchers believed that one GLG was laid down annually. On this basis, the mean ASM for female humpback whales has been generally believed to be between eight and twelve years (summarised in Lockyer, 1984). Until recently, no data were available from living humpback whales on the attainment of sexual maturity. The first recorded observations of third generation calves were reported by Clapham and Mayo (1987b).

In order to examine this question further, we re-estimated the mean ASM from our data, making three different assumptions about the age of the eight of our thirteen whales for which we did not know the age. Assuming them all to be 1, 2 or 3 years of age at first sighting, results in mean ASM values of 5.54, 6.15 and 6.77 years respectively. While it is difficult to estimate length (and hence age) at sea, we believe that at least three of the eight were probably yearlings when first seen, based on a comparison with known yearlings and on changes in fluke patterns which are most likely to occur in the first two years of life (Carlson, Mayo and Whitehead, 1990). Thus, the estimate of 6.77 years at least seems too high. However other factors may serve to inflate or reduce the ASM: some of the 13 females may have matured earlier than our data suggest, but did not conceive or lost their calf before reaching the study area; two other females, not included in the Table were never seen with calves – their year of first sighting suggests that if they reached maturity, it was at ages of at least seven and nine years.

Overall, these data contradict the prevailing hypothesis (Lockyer, 1984) that most female humpback whales attain sexual maturity at between eight and twelve years. Rather, they confirm Chittleborough's (1959; 1965) belief that the majority of females reach maturity by the age of six and that two GLGs are laid down annually in the earplugs of humpback whales.

Return and recruitment of calves

The consistently high frequency with which calves return to the study area after separation from their mothers provides continuing strong support for the belief that the composition of a humpback whale feeding stock is determined matrilineally (Mayo and Clapham, 1983; Baker, Herman, Perry, Lawton, Straley, Wolman, Kaufman, Winn, Hall, Reinke and Ostman, 1986; Clapham and Mayo, 1987a). The percentage of calves observed to our assumed ASM of six years is consistent with that reported for the same population from a shorter study period (Clapham and Mayo, 1987a) and supports our earlier suggestion that a calf surviving its first year of life is likely to be recruited into the breeding population. The sample size is still too small for conclusions to be drawn with confidence, and the mass mortality noted above will confound the issue further. The fact that at least two whales from this group were involved in entanglements (and were not seen thereafter) suggests that entrapments may represent a significant cause of mortality in this population. That Gulf of Maine humpbacks may be frequently involved in entanglements is supported by the percentage (7%) of surviving humpbacks from this area that exhibit entanglement-related scars (J. Ray, pers. comm.).

Individual identification techniques

The data presented here further confirm the value of techniques for the identification of individuals based upon natural markings. We have found that variation in the shape, size and scarring of the dorsal fin is almost equally as useful as the widely-used ventral fluke pattern in identifying individuals over long periods. However, our coverage of the study area is extremely intensive, with trips conducted on a daily basis for seven months of the year, and less regular coverage at other times. As a result, it is not uncommon for us to observe individuals frequently during a season (some whales have been seen on up to 83 separate days). This technique can provide a great deal of information about individuals, as well as a valuable means of detecting the changes in ventral fluke pattern that occur in a small percentage of young animals (Carlson, Mayo and Whitehead, 1990). Use of a recording databack (allowing direct placement of date or coded information onto the negative) and/or descriptive field notes is essential to ensure that the dorsal fin and fluke pattern of an individual are correctly associated during subsequent analysis of photographs.

ACKNOWLEDGEMENTS

The authors thank Brier Island Ocean Study, College of the Atlantic, the Gloucester Cetacean Research Unit, and the numerous other contributors to the North Atlantic Humpback Whale Catalogue for providing supplemental sighting data on certain individual whales. We are also indebted to Lisa Baraff, Carole Carlson and Sharon Pittman for assistance with data management, to Janet Biondi and Harriet Corbett for graphics assistance, and to Christina Lockyer and Roger Payne for their advice concerning certain sections of the manuscript. This study was funded in part by the National Marine Fisheries Service (Northeast Fisheries Center) under contract number 50-EANF-6-00059. Additional support from the International Wildlife Coalition, the World Wildlife Fund (US), the Phipps Florida Foundation and the Seth Sprague Charitable Trust is gratefully acknowledged.

REFERENCES

- Baker, C.S., Herman, L.M., Perry, A., Lawton, W.S., Straley, J.M. and Straley, J.H. 1985. Population characteristics and migration of summer and late season humpback whales (*Megaptera novaeangliae*) in southeastern Alaska. *Mar. Mamm. Sci.* 1(4):304-23.
- Baker, C.S., Herman, L.M., Perry, A., Lawton, W.S., Straley, J.M., Wolman, A.A., Kaufman, G.D., Winn, H.E., Hall, J.D., Reinke, J.M. and Ostman, J. 1986. Migratory movement and population structure of humpback whales (*Megaptera novaeangliae*) in the central and eastern North Pacific. *Mar. Ecol. Prog. Ser.* 31:105-19.
- Baker, C.S., Perry, A. and Herman, L.M. 1987. Reproductive histories of female humpback whales (*Megaptera novaeangliae*) in the North Pacific. *Mar. Ecol. Prog. Ser.* 41:103-114.
- Buckland, S.T. 1990. Estimation of survival rates from sightings of individually identifiable whales. Paper SC/A88/ID5 (published in this volume).
- Carlson, C.A., Mayo, C.A. and Whitehead, H. 1990. Changes in the ventral fluke pattern of the humpback whale (*Megaptera novaeangliae*) and its affect on matching: evaluation of its significance to photo-identification research. Paper SC/A88/ID35 (published in this volume).
- Chittleborough, R.G. 1959. Determination of age in the humpback whale, *Megaptera nodosa* (Bonnaterre). *Aust. J. Mar. Freshw. Res.* 10(2):125-43.
- Chittleborough, R.G. 1960. Marked humpback whale of known age. *Nature* 187:164.
- Chittleborough, R.G. 1965. Dynamics of two populations of the humpback whale, *Megaptera novaeangliae* (Borowski). *Aust. J. Mar. Freshw. Res.* 16:33-128.
- Clapham, P.J. and Mayo, C.A. 1987a. Reproduction and recruitment of individually-identified humpback whales, *Megaptera novaeangliae*, observed in Massachusetts Bay, 1979-1985. *Can. J. Zool.* 65(12):2853-63.
- Clapham, P.J. and Mayo, C.A. 1987b. The attainment of sexual maturity in two female humpback whales. *Mar. Mamm. Sci.* 3(3):279-83.
- Geraci, J.R., Anderson, D.M., Timperi, R.J., St. Aubin, D.J., Early, G.A., Prescott, J.H. and Mayo, C.A. 1989. Humpback whales (*Megaptera novaeangliae*) fatally poisoned by dinoflagellate toxins. *Can. J. Fish. Aquat. Sci.* 46(11):1895-8.
- Glockner, D.A. 1983. Determining the sex of humpback whales (*Megaptera novaeangliae*) in their natural environment. pp. 447-64. In: R.S. Payne (ed.) *Behavior and Communication of Whales*. AAAS Selected Symposium No. 76, Boulder, Co. 643pp.
- Glockner-Ferrari, D.A. and Ferrari, M. 1990. Reproduction in the humpback whale, *Megaptera novaeangliae*, in Hawaiian waters, 1975-1988: The life history, reproductive rates, and behaviour of known individuals identified through surface and underwater photography. Paper SC/A88/ID30 (published in this volume).
- Herman, L.M. and Antinaja, R.C. 1977. Humpback whales in Hawaiian breeding waters: population and pod characteristics. *Sci. Rep. Whales Res. Inst., Tokyo* 29:59-85.
- Katona, S.K., Harcourt, P.M., Perkins, J.S. and Kraus, S.D. 1980. Humpback whales: a catalogue of individuals identified in the western North Atlantic Ocean by means of fluke photographs. College of the Atlantic, Bar Harbor, Maine.
- Lockyer, C.L. 1984. Review of baleen whale (Mysticeti) reproduction and implications for management. *Rep. int. Whal. Commn* (special issue 6):27-48.
- Mathews, L.H. 1937. The humpback whale, *Megaptera nodosa*. *Discovery Rep.* 17:7-92.
- Mayo, C.A. 1982. Observations of cetaceans: Cape Cod Bay and Stellwagen Bank Massachusetts 1975-1979, NTIS, Report MMC-80/07, Springfield, VA.
- Mayo, C.A. and Clapham, P.J. 1983. Observations of humpback whale mother-calf pairs on Stellwagen Bank, Massachusetts: 1979-1983. Abstract from the Fifth Biennial Conference on the Biology of Marine Mammals, Boston, Massachusetts.
- Nishiwaki, M. 1959. Humpback whales in Ryukyuan waters. *Sci. Rep. Whales Res. Inst., Tokyo* 14:49-87.
- Whitehead, H. 1982. Populations of humpback whales in the Northwest Atlantic. *Rep. int. Whal. Commn* 32:345-53.

The Reproductive Cycle in Gray Whales Based on Photographic Resightings of Females on the Breeding Grounds from 1977–82

Mary Lou Jones

Cetacean Research Associates, 4610 43rd Street, NW, Washington, DC 20016, USA

ABSTRACT

Gray whales (*Eschrichtius robustus*) with distinctive natural markings were systematically photographed in San Ignacio Lagoon, Mexico from 1977 to 1982. In this paper, information is presented on breeding cycles for individually known females, including the range of values observed for length of calving interval and the relative frequencies of different length calving intervals (expressed in years). About 6,000 photographs were taken and 562 different gray whales were identified. Among these were 55 sexually mature females that were followed through 2 to 6 seasons on their winter breeding grounds; they produced a total of 115 calves over the 6-year period.

The length of time between the birth of consecutive calves was documented for 42 cows. Calving intervals ranged from 1–4 years, but were predominantly 2 years (1 calf every other year). The observed intervals were: 1 year (n=1), 2 years (n=48), 3 years (n=6) and 4 years (n=5). The mean length of the calving interval, or breeding cycle, for the population from 1977–82, was estimated as 2.11 (SD=0.403) years.

INTRODUCTION

Knowledge of the periodicity of calving, or the duration of the reproductive cycle, is useful information in fishery biology for predicting birth rate, population growth and recruitment, and hence production (Lockyer, 1984). For the eastern Pacific stock of gray whale (*Eschrichtius robustus*) life history data for the estimation of vital rates are available from two fisheries: a series of gray whales examined from the Soviet subsistence fishery in the waters of Chukotka Peninsula (reviewed in Tomilin, 1957; Zimushko, 1969; Yablokov and Bogoslovskaya, 1984; Blokhin, 1984; 1985; 1986; 1987) and a series collected off the California coast for US scientific research (Rice and Wolman, 1971). In both samples, estimates of reproductive rates come from examination of ovarian and other morphological data. Although these studies provide the best information available, sampling bias in terms of both selecting the animals taken in the fishery and selecting which of the animals taken are to be examined, makes it difficult to determine how representative the data are of the population as a whole.

Several questions remain unresolved from the examination of the catch data. One of these is the minimum biologically possible calving interval, important for the estimation of the maximum rate of increase of a population (Reilly, 1984). While it is generally agreed that the most common cycle is two years between calves (e.g. Rice and Wolman, 1971; Blokhin, 1984a and c) there is some disagreement over the extent to which a one-year cycle can occur. Zimushko (1969) reported examining seven simultaneously pregnant and lactating females but did not state how many females he had examined. Yablokov and Bogoslovskaya (1984) stated that between 1965–68 'about 20% of such females were encountered' but do not report 20% of what. Rice and Wolman (1971) however proposed that the potential for post-partum pregnancy was being or had been genetically eliminated from the stock. Recent reports on the Soviet harvest (e.g. Blokhin, 1984b; 1985; 1986; 1987) have not recorded simultaneously pregnant and lactating females. It should be noted, however, that in addition to the sampling bias

referred to earlier, the representativeness of the catch is further confounded because cows accompanied by calves (essentially, lactating females) are protected under International Whaling Commission regulations. The catch data also provide little information on the range and frequency of calving intervals and whether this varies with time. Yablokov and Bogoslovskaya (1984) hypothesise that pregnancy rate decreases with age, while Blokhin (1984a) believes it does not.

The annual migration of the eastern Pacific stock of gray whales between its northern feeding grounds in the Bering and Chukchi Seas and its southern breeding grounds off California, the Baja Peninsula and mainland Mexico makes it especially well suited to study by means of photo-identification. Members of this population travel close to shore during their migrations and breed near shore and in coastal lagoons. In the breeding areas, the likelihood of observing a large number of whales from year to year is very good, which makes the task of assessing reproductive parameters, like calving interval, relatively easy, albeit time consuming.

One of the distinguishing features of gray whales is their mottled gray skin, due to both natural pigmentation and extensive scarring from dead barnacles. The darkness of the background and the extent of light blocking vary in each whale and can serve as a visual tag, of which no two are alike. Research by Hatler and Darling (1974) and Darling (1984), who were the first to study gray whales using individual photo-identification techniques, has shown that the longevity of markings is at least 11 years, and that the technique can be reliably used as a basis for long-term studies of this species.

This paper presents some of the findings of a six-year photo-identification study of live, free-ranging gray whales on their breeding grounds in San Ignacio Lagoon, Baja California, Mexico (Jones and Swartz, 1985). From 1977 through 1982, mature females were identified and their reproductive histories were documented in an effort to further clarify and verify the existent knowledge on breeding cycles and other aspects of their life history. Data on periodicity of calving were analyzed with three goals in mind: (1) to determine the range of values for length of the

breeding cycle; (2) to ascertain the relative frequencies of the different intervals; and (3) to discover whether the length of the breeding cycle for individual females was constant or variable over time.

METHODS

Study site

San Ignacio Lagoon, on the Pacific coast of Baja California, Mexico, is an estuary on the extremely arid and barren Desierto De Vizcaino (Fig. 1). Opening off the wide bight of Bahía de Ballenas at $26^{\circ}45'N$, the lagoon is about 32km long, and from 1.8 to 6.5km wide. The shoreline is composed of areas of sand beach, rock-shell conglomerate and mangrove marshes. The interior has a basin at its head and a system of channels (cut by the tidal currents) separated by shoals, many of which are exposed at low tide. Much of the lagoon is shallow. Extensive intertidal sand and mud flats along the shore restrict whales to more central locations. Although the lagoon's surface area is 152km^2 , only about 87km^2 (57%) is deep enough ($>2\text{m}$) for whales.

San Ignacio Lagoon, which supports the second largest number of gray whales was selected as the study site because it is the least developed of all the major breeding lagoons, facilitating studies of 'normal' whale behavior.

Study design

It was not feasible to photograph every whale in every season because up to 500 or 600 whales occupied the lagoon at any one time during the peak of the season (Jones and Swartz, 1986). To reduce the number of photographs to be analysed, it was decided to photograph selectively only those whales bearing obvious marks which were visible to the naked-eye at moderate ranges for observers in small boats. It was assumed that all whales had an equal opportunity of being encountered, and that the animals with obvious marks were a representative sample of the population. Analysing the data using capture-recapture methods to estimate population size was not an objective of the study.

To identify gray whales, photographs were taken of the dorsal ridge, back (preferably close to the middle of the back) or anterior portion of the peduncle. The dorsal ridge was preferred since it was the most prominent and easily observed portion of a surfacing whale and was consistently visible each time the whale surfaced. If the left and right sides of the whale had distinctive marks, photographs of both sides were obtained (when possible) to prevent counting the animal as two whales. Individuals with unique features such as a broken back or peduncle, deformed or missing flukes and wounds were also photographed. Fluke patterns generally could not be used for identification because whales in San Ignacio Lagoon rarely raised their flukes above the water's surface when diving, as they do on the northern range and during migration.

Whales were photographed with *Ektachrome* 200 film, using 35mm single-lens reflex cameras with motor-drives and 70–210mm or 100–300mm zoom telephoto lenses. To minimize parallax and angular distortion, photographs were taken directly perpendicular to the longitudinal axis of the whale, with the sun behind the camera; where possible a sequence of photographs taken at slightly different angles (ahead and behind) were taken to allow a choice of the most useful angle for identification.

The general procedure for obtaining photographs was as follows. Prior to approaching a whale, its breathing pattern was timed and its behavior noted. A slow approach was made, preferably from behind and to the side of the whale. It was followed through several dive sequences until several identifying photographs were taken. If the whale showed evasive behavior, the approach was discontinued. Otherwise the approach continued to within 30m whenever possible.

Sighting data recorded included date, time of day, location, behavior and presence of a calf. An effort was made to determine the sex of animals, but the sex could be determined only for females with calves or in the rare case of matching a ventral view of a whale with a dorsal view of the same animal.

Photographs (slides) were classified chronologically according to type and size of the mark, the side or sides of the whale depicted and the location of the mark on the body (ordered from anterior to posterior). A catalog was then compiled which contained a clear picture and an information file on each whale.

Field work began in late December or early January and continued until early April of each year from 1977 through 1982. Whales were systematically photographed on two days per week (separated by a 4–5 day interval) from a 4.7m outboard-powered boat. Generally, weather permitting, a roundtrip traverse of the lagoon was made along a mid-lagoon transect from the breaker line near the

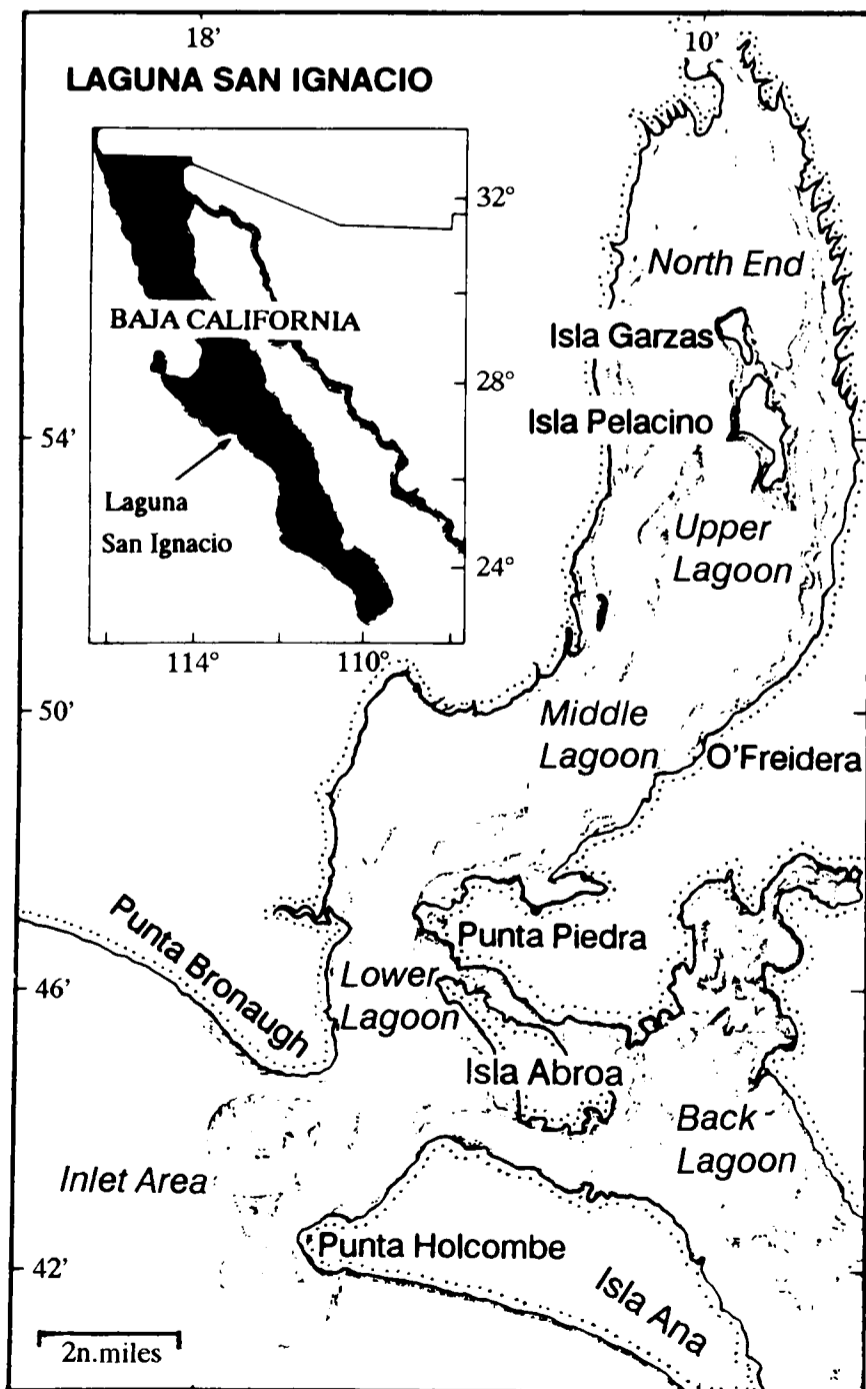

Fig. 1. San Ignacio Lagoon, Baja California Sur, Mexico.

inlet, north to the head of the lagoon; diversions were made to photograph whales as they were encountered. This provided a minimum of four opportunities per week to identify additional individuals, and to resight whales encountered earlier in a given season or seasons. The photo-identification study was one task in a multi-task research program on gray whales, human activities and the ecosystem in San Ignacio Lagoon (Swartz and Jones, 1981; Jones and Swartz, 1986; Swartz, 1986). Additional photographs were taken opportunistically two days per week during vessel surveys (to census the number of whales) and two days per week during shore-based surveys from an observation tower (to record whale behavior). During the six-year study, a total of 1,710 hours of photographic field work was conducted; the annual level of photo-identification effort was approximately constant at about 285 hours (Table 1).

Table 1

Summary of six-year photo-identification effort at San Ignacio Lagoon.

	Year						Total
	1977	1978	1979	1980	1981	1982	
No. photos taken	1,100	500 ¹	1,044	1,080	1,150	1,200	6,074
No. gray whales identified	87	72	128	85	66	124	562
No. resighted in previous years	0	11	20	29	30	42	132
No. resighted in other years	17	26	31	34	29	42	179

¹ In 1978, 50% of the photographs were lost due to a processing malfunction.

RESULTS

Whale identifications and re-sightings

From 1977 to 1982, 562 gray whales were identified in San Ignacio Lagoon. Of these, 55 mature females were photographed among years: 13 were photographed in 2 years, 8 in 3 years, 8 in 4 years, 16 in 5 years and 10 in all 6 years.

The reproductive histories collected for the 55 females during the study revealed: 1 female gave birth to 4 calves in a 6-year period; 16 females each had 3 calves in a 5 or 6-year period; 25 females each had 2 calves in a 3 or 4-year period; and 13 females had 1 calf in a 2-year period. The sum of the number of years from the first to the last sighting of these known whales was 223 and the total number of calves observed was 115.

All of the births were of a single calf; no twins were observed. Although at least one set of twins has been found *in utero* in the gray whale (Blokhin, 1987), there is no evidence of mature delivery of these young.

None of the females observed in this study exhibited long lasting or overlapping maternal care for successive offspring. All calves were young-of-the-year. This corroborates other observations that gray whale calves are dependent upon lactating mothers only until weaning occurs. Bogoslovskaya (1986), in her review of the social behavior of gray whales on their northern feeding grounds off Chukotka and Koryaka between 1977 and 1983, stated that:

ID no.	1977	1978	1979	1980	1981	1982
77F01	●	○	●	○	●	○
77F02	●	○	○	●	○	●
77F03	●	○	○	●	○	●
77F04	●	○	●	○	●	○
77F05	○	○	○	●	○	●
77F06	●	○	○	●	○	●
77F07	●		●	○		●
77F08	●		●	●		●
77F09	●	○	●		●	○
77F10	●		●		●	
77F11	●	○	●			●
77F12	●	○	●	○		
77F13	●				●	
77F14	●		●		●	
78F01		●		●		●
78F02		●		●		●
78F03		●				●
78F04		●				●
78F05		●			●	○
78F06		●			○	●
78F07		○	●		●	○
78F08		●		●		●
78F09		○		●		●
78F10		●		●		●
78F11		●	○	○	○	●
78F12		●		●		●
78F13		●		●		●
79F01			●		●	○
79F02			○	●		●
79F03			○	●	○	●
79F04			●	○	●	
79F05			●		●	○
79F06			●		●	○
79F07			●		●	○
79F08			○	●		●
79F09			●	○	●	○
80F01				●		●
80F02				●	○	●
80F03				●	○	●
80F04				●	○	●
80F05				●	○	●
80F06				●	○	●

Fig. 2. Reproductive histories of the 42 female gray whales observed with two or more calves during the study period in San Ignacio Lagoon. Solid circles indicate years females were observed with a different calf, open circles represent years they were seen without a calf and blank spaces indicate years they were not seen at all.

'In July and August, the calves generally leave their mothers and assemble together in certain areas. Some mothers remain with their calves for much longer periods, usually if the calf is weak (either through ill health or if it was born late in the season).'

Calving interval

The calving interval, as defined here, is the period of time (given in years) between the birth of successive calves. Barlow (1990) discussed different ways of estimating calving interval. The time span between calvings was

recorded for 42 cows, which gave birth to a total of 102 calves during the study, providing information on a total of 60 calving intervals (Fig. 2). Periodicity of calving ranged from annual (1 case) to a 4-year period between calves (1 case), but was predominately biennial (80%) (Table 2). The observed intervals (and frequencies) were: 1 year ($n=1$), 2 years ($n=48$), 3 years ($n=6$) and 4 years ($n=5$).

The average length of the calving interval, or breeding cycle, for the female population during the six-year period was $2.25 \pm \text{SD } 0.628$ years. One bias inherent in this estimation, however, is that some of the longer calving intervals may represent animals that had an undetected calf in the interim. In particular, this estimate may be biased upward by the four females in the sample that had a calf in the first and fifth years of a 5-year period (apparent 4-year calving interval), but for which no data are available for the presence or absence of a calf in the third year because they were not seen in that year. Considering that 80% of all the calving intervals lasted two years, and because annual breeding appears to be rare (1 case in 223 female years), this suggests that the four cows did produce a calf during the third year resulting in two biennial cycles, rather than one 4-year cycle. Using this assumption as one way of correcting for the biased representation of longer intervals results in a revised mean calving interval of $2.11 \pm \text{SD } 0.403$ years ($n=64$, Table 2).

Of the 42 sexually mature females sampled on the winter grounds, 30 (71.4%) animals exhibited only a two-year breeding cycle, 1 (2.4%) was on a three-year cycle, 5 (11.9%) were on an apparent four-year cycle, 5 (11.9%) were on a variable two/three-year cycle and 1 (2.4%) female was on a variable one/two-year cycle. As explained previously, 4 of the 5 females on an apparent four-year cycle were possibly on a shorter breeding cycle, hence the value may be as low as 1 (2.4%) for this category (Table 3).

The one female that produced a calf in two successive years probably lost her first calf shortly after its birth. This cow was seen early in the season with her first calf, and was photographed without a calf later in the season. She was then seen again with a calf the next year. This suggests that the postpartum ovulation with conception possibly resulted because of the loss of the calf.

Table 2

Frequency distribution of the calving intervals documented for mature female gray whales photographed in San Ignacio Lagoon from 1977 through 1982.

Length of calving interval ¹ (in years)	Frequency		Proportion	
	$n = 60$	$(n = 64)^2$	$n = 60$	$(n = 64)$
1	1	(1)	0.017	(0.016)
2	48	(56)	0.800	(0.875)
3	6	(6)	0.100	(0.093)
4	5	(1)	0.083	(0.016)
Mean	2.25	(2.11)		
Standard Deviation	0.628	(0.403)		

¹ Calving interval is defined as the time between births of consecutive calves. Calving intervals longer than the study period will not be represented at all.

² Assumes that 4 of the 5 females that had a calf in the first and fifth years of a 5-year period (apparent 4-year calving interval) produced a calf during the third year that went undetected. In this case, two consecutive biennial cycles, rather than one 4-year cycle, would be indicated for each female, thus increasing the number of intervals from 60 to 64 (see text).

Table 3

Summary of the reproductive histories of 42 female gray whales showing length of the breeding cycle for individuals observed from 1977 through 1982.

Length of breeding cycle (in years)	No. females	Proportion
2	30 (34) ²	0.714 (0.809)
3	1	0.024
4	5 (1)	0.119 (0.024)
1 & 2 ¹	1	0.024
2 & 3	5	0.119

¹ Variable cycle (some females had cycles of different lengths).

² Assumes that 4 of the 5 cows that had a calf in the first and fifth years of a 5-year period (apparent 4-year calving interval) produced a calf during the third year that went undetected. In this case, two consecutive biennial cycles, rather than one 4-year cycle, would be indicated for each cow, thus increasing the number of females with 2-year cycles from 30 to 34, and decreasing the number of females with 4-year cycles from 5 to 1 (see text).

DISCUSSION

The most common breeding pattern observed during our study period was a biennial cycle. This is consistent with previous reports. It is important to note, however, that there was considerable individual variation in calving interval. One female was found to breed annually (see below) while from 8 to 11 others reproduced after two or more resting years between calves. This agrees with Zimushko's (1969) finding that some females rest more than one year between calves. The apparent flexibility in reproductive cycle may be dependent upon a female's age, general health and nutritive condition. The occurrence of longer calving intervals (2, 3 and 4 years) could also be indicative of some cows having missed pregnancies or having failed to carry pregnancies to term. Missed pregnancies indicate either a failure to ovulate, or a failure to conceive following ovulation (Rice and Wolman, 1971).

Further data are needed to address the question of whether calving interval is a function of age. Sociobiological research on the pattern of age-specific fecundity for large wild mammals supports Blokhin's (1984) view that pregnancy rate does not increase with age; findings suggest that

'if experience improves reproductive performance, young individuals reproduce at a lower rate than fully mature individuals. If not, reproductive rate is relatively constant for all age groups until senescence set in' (Wittenberger, 1981).

To verify the existence and/or pattern of age-specific fecundity in gray whales, long-term behavioral studies of identified females of known age will be needed.

Our results indicate that annual pregnancy can occur but that postpartum ovulation in females which have not lost a calf is probably not a regular occurrence in this species. This contrasts with the Yablokov and Bogoslovskaya's (1984) report of 'about 20%' between 1965-8, but is in accord with recent reports from the harvest (Blokhin, 1984-7). However, the question of protection of whales accompanied by calves, and the possibility that the percentage of occurrence of annual breeders may decrease as a population approaches carrying capacity, makes resolution of the apparent inconsistency difficult. Due to

the limited sample size of this study additional research is needed to address this question adequately. As noted by Rice (1983):

'even with the gestation period longer than 365 days, a female could still bear a calf two years in succession, but in the second year the reproductive cycle would be somewhat delayed. Successive annual pregnancies could not be repeated very long, however, because the reproductive cycle would soon get out of phase with the annual cycle.'

Closing remarks

Although gray whales are perhaps the best studied of all baleen whales, much research is still needed to describe fully their life history, population dynamics and social structure. The photographic identification data collected during this six-year study provide a foundation for further studies.

The eastern Pacific stock is relatively easy to study in this regard. The confined breeding area, with consistent presence of a large number of whales during the winter and the clement weather conditions in the breeding lagoons readily permit photo-identification work; there is a very good chance of resighting many known gray whales from year to year. The importance of *continuous* long term photo-identification studies to obtain information on biological parameters has been recognised (IWC, 1990). It is important that such studies on this stock begin again before the value of the present study is lost. A program to obtain photographs of the Soviet catch of gray whales for comparison with animals individually identified elsewhere has been discussed (IWC, 1987, p.113). Comparison of the biological material from this catch with photographic histories obtained from individually known animals on the breeding grounds provides a unique opportunity to calibrate some of the reproductive parameters previously derived solely from the study of harvested whales.

ACKNOWLEDGEMENTS

I would especially like to thank Steven Swartz, my co-investigator for the multi-tasked research program on gray whales in San Ignacio Lagoon, for his assistance and advice in all phases of this work. Special thanks are extended to field assistants: M. Bursk, G. Dana, M. Symons, B. Reitherman, J. Sumich, D. Miller, J. Essley and D. Miller. Logistical support was provided by B. Mathers, M. Symons, R. Jones, M. Bursk, Fisherman's Landing and H & M Landing (San Diego, CA). I wish to acknowledge the late Raymond Gilmore, Laura Hubbs and Carl Hubbs for graciously sharing their knowledge of gray whales and for their enthusiastic support of this research. I also thank Jim Darling for his generous advice on photographic techniques for identifying gray whales during the early development of the study.

Research was conducted under Permit No. 163 issued by the US Department of Commerce (NOAA/NMFS). Thanks are offered to E.P. Jaime, J.C. Fraiser, A. Yanez, A. Lopez, W. O'Campo, P.M. Sanchez and L.A. Fleischer for handling the permit requests in Mexico. Scientific research in Mexico was authorized under permits No. 14203 (1977), No. 12-459-498 (1978), No. 920 (1979), No. 10919 (1980), No. 10455 (1981) and No. 4048 (1982) issued by the Secretaria de Pesca, Direccion General de Regulacion Pesquera de Mexico.

The work was funded by: World Wildlife Fund, National Geographic Society, International Union for Conservation of Nature, US Marine Mammal Commission,

International Whaling Commission, American Cetacean Society, National Marine Mammal Laboratory (NOAA/NMFS), Hubbs Research Institute, San Diego Natural History Museum and Cetacean Research Associates.

Comments from Steven Swartz, two anonymous reviewers and the editors greatly improved the manuscript. Special thanks are offered to Sally Mizroch whose assistance and cooperation facilitated the preparation of this paper.

REFERENCES

- Barlow, J. 1990. A birth-interval model for estimating reproductive rates from resighting data. Paper SC/A88/ID6 (published in this volume).
- Blokhin, S.A. 1984a. Investigations of gray whales taken in the Chukchi coastal waters, U.S.S.R. pp. 487-509. In: M.L. Jones, S.L. Swartz and S. Leatherwood (eds) *The Gray Whale, Eschrichtius robustus*. Academic Press, Inc., Orlando, Florida. i-xxiv + 600pp.
- Blokhin, S.A. 1984b. Investigation of gray whales taken off Chukotka in 1982. *Rep. int. Whal. Commn* 24:461-3.
- Blokhin, S.A. 1984c. Some aspects of reproduction in the California-Chukchi stock of gray whales. *Rep. int. Whal. Commn* 34:457-9.
- Blokhin, S.A. 1985. Investigation of gray whales taken off Chukotka in 1982. *Rep. int. Whal. Commn* 35:371-4.
- Blokhin, S.A. 1986. Investigations of gray whales taken off Chukotka in 1984. *Rep. int. Whal. Commn* 36:287-90.
- Blokhin, S.A. 1987. Investigations of gray whales taken off Chukotka in 1985. *Rep. int. Whal. Commn* 37:337-9.
- Blokhin, S.A. and Vladimirov, V.L. 1983. Investigation of gray whales taken off Chukotka in 1981. *Rep. int. Whal. Commn* 33:553-5.
- Bogoslovskaya, L.S. 1986. On the social behavior of gray whales off Chukotka and Koryaka. *Rep. int. Whal. Commn* (special issue 8):243-51.
- Darling, J.D. 1984. Gray whales off Vancouver Island, British Columbia. pp. 265-80. In: M.L. Jones, S.L. Swartz and S. Leatherwood (eds) *The Gray Whale, Eschrichtius robustus*. Academic Press, Inc., Orlando, Florida. i-xxiv + 600pp.
- Hatler, D.F. and Darling, J.D. 1974. Recent observations of the gray whale in British Columbia. *Can. Field Nat.* 88:449-59.
- International Whaling Commission. 1987. Report of the Scientific Committee. *Rep. int. Whal. Commn* 37:28-145.
- Jones, M.L. and Swartz, S.L. 1985. Photographic identification study of gray whale reproduction, distribution, and duration of stay in San Ignacio Lagoon, and inter-lagoon movements in Baja California. Presented to the Sixth Conference on the Biology of Marine Mammals, Vancouver, Canada, November 1985 (unpublished).
- Jones, M.L. and Swartz, S.L. 1986. Demography and phenology of gray whales and evaluation of human activities in Laguna San Ignacio, Baja California Sur, Mexico: 1978-1982. U.S. Mar. Mamm. Commn, Rep. No. MM2324713-8. 69pp. Available from: NTIS, Springfield, VA: PB86-219078.
- Lockyer, C. 1984. Review of baleen whale (mysticeti) reproduction and implications for management. *Rep. int. Whal. Commn* (special issue 6): 27-50.
- Reilly, S.B. 1984. Observed and maximum rates of increase in gray whales, *Eschrichtius robustus*. *Rep. int. Whal. Commn* (special issue 6): 389-99.
- Rice, D.W. 1983. Gestation period and fetal growth of the gray whale. *Rep. int. Whal. Commn* 33:539-43.
- Rice, D.W. and Wolman, A.A. 1971. Life history and ecology of the gray whale (*Eschrichtius robustus*). *Amer. Soc. Mammal., Spec. Publ.* 3:1-142.
- Swartz, S.L. and Jones, M.L. 1981. Demographic studies and habitat assessment of gray whales, *Eschrichtius robustus*, in Laguna San Ignacio, Baja California Sur, Mexico. U.S. Mar. Mamm. Commn, Rep. No. MM2079219-4. 56pp. Available from: NTIS, Springfield, VA: PB86-219078.

- Swartz, S.L. 1986. Demography, migrations, and behavior of gray whales *Eschrichtius robustus* (Lilljeborg, 1861) in San Ignacio Lagoon, Baja California, Sur, Mexico and in their winter range. Ph.D. Dissertation. University of California, Santa Cruz, California. 85pp.
- Tomilin, A.G. 1957. Zveri SSSR I Prilezhasfchikh Stran. Zveri Vostochnoi Evropy I Severnoi Azii. Vol. IX. Kitoobraznye. Izdatel'stvo Akademi Nauk SSSR, Moscow. 756pp. [Translated in 1967 as *Mammals of the USSR and Adjacent Countries. Mammals of Eastern Europe and Adjacent Countries. Vol. IX. Cetacea* by the Israel Program for Scientific Translations, Jerusalem, 717pp.].
- Wittenberger, J.F. 1981. *Animal Social Behavior*. Duxbury Press, Boston. i- xi + 722pp.
- Yablokov, A.V. and Bogoslovskaya, L.S. 1984. A review of Russian research on the biology and commercial whaling of the gray whale. pp. 465-485. In: M.L. Jones, S.L. Swartz and S. Leatherwood (eds) *The Gray Whale, Eschrichtius robustus*. Academic Press, Inc., Orlando, Florida. i-xxiv + 600pp.
- Zimushko, V.V. 1969. Some data on the biology of gray whales. pp. 93-7. In: V.A. Arseniev, B.A. Zencovich and K.K. Chapskii (eds) *Morskie mlekopitayushchie*. Akad. Nauk USSR, Moscow.
- Zimushko, V.V. and Ivashin, M.V. 1980. Some results of Soviet investigations and whaling of gray whales (*Eschrichtius robustus* Lilljeborg, 1861). *Rep. int. Whal. Commn* 30:237-46.

Estimating Population Size in Southern Right Whales (*Eubalaena australis*) Using Naturally Marked Animals

P.B. Best

Mammal Research Institute, University of Pretoria, Pretoria¹

and

L.G. Underhill

Department of Mathematical Statistics, University of Cape Town, Rondebosch, South Africa

ABSTRACT

In annual photographic surveys of southern right whales off the South African coast from 1979 to 1987, 236 adult females were individually identified from variation in callosity and colouration patterns. Because the surveys concentrated on cows with calves, and calving intervals ranged from two to four or more years with most at three years, the probabilities of recapture (=rephotography) were clearly unequal among years. The population was also increasing. In order to estimate population size a purpose-built mark-recapture model based on the Bayesian method for closed populations was developed to handle the unequal capture probabilities and the increasing population size. Results were relatively insensitive to a range of likely adult survival and population increase rates, and the best estimate for the 1987 population size was 286 adult females (approximate 95% confidence limits 265, 310). Estimates of population growth rate were also derived from the series of annual population estimates for 1983 to 1987.

INTRODUCTION

Southern right whales *Eubalaena australis* were greatly depleted in numbers by the activities of open-boat whalers from the late eighteenth to late nineteenth centuries, and by modern whalers in the first decades of the twentieth century. Given legal protection in 1935, the species has begun to show signs of recovery in a number of localities in the Southern Hemisphere (Bannister, 1986a; Best, 1981; Whitehead, Payne and Payne, 1986). The population visiting South African waters is increasing at an annual rate of 6.8% (Best, 1990).

Because right whales are protected, the dynamics of the population and their vital parameters have perforce to be studied using non-destructive means. A key advance in this process was the discovery that individual right whales can be recognised from natural variation in the number, position and shape of wart-like callosities that occur universally on the head of the species (Payne, Brazier, Dorsey, Perkins, Rowntree and Titus, 1983). In this paper the rates of resighting of such 'naturally-marked' individuals in regular, systematic aerial photographic surveys off the South African coast have been used to obtain estimates of population size.

Right whales visit the southern coast of South Africa each winter and spring. Because about 25% of the non-calves seen on the South African coast each year are adult cows with calves (Best, 1981), and because on average a female only gives birth every third year (Best, in press), it is clear that the age and sex composition of the inshore population is not representative of the right whale population as a whole. However, sightings of right whales with calves outside coastal waters in winter are rare (Bannister, 1986b), so that the only segment of the population that might be fully represented in coastal waters

in winter would be the adult females in a perinatal condition. We therefore consider only this segment of the population.

In this study, sampling of the population through photography each year was therefore confined to females accompanying calves. This means that an animal, even if it is present in coastal waters at the time and place of the survey, will not be sampled (photographed) unless it is accompanied by a calf. Because the calving interval of the individual females varies, recapture probabilities between sampling periods (years) are unequal. In this situation, conventional mark-recapture models are not immediately applicable.

A Bayesian method for estimating the size of an animal population from capture-recapture experiments was developed independently by Zucchini and Channing (1986) and by Gazey and Staley (1986). This method assumes that the population is closed and that all animals, marked and unmarked, have, at all times, the same probability of recapture. In the data set analysed in this paper, these assumptions did not hold: the population was increasing and probabilities of recapture for any given animal varied between years. Because the animals were not actually physically marked, it is reasonable to assume that there was no difference in the behaviour of marked and unmarked animals (Hammond, 1986). We use the terms 'marked' and 'unmarked' to indicate known (previously photographed) and unknown whales, respectively. A purpose-built model, based on the Bayesian method for a closed population, was developed to handle the unequal recapture probabilities and the increasing population size. The sensitivity of the model to variations in the parameters was investigated.

Raftery, Turet and Zeh (1988) have also applied Bayesian methods to estimating the size of a whale population. However, they were not using capture-recapture techniques, but used Bayesian methods to combine visual and acoustic data of whale tracks with a model of whale behaviour.

¹ Postal address: c/o South African Museum, PO Box 61, Cape Town, 8000 South Africa.

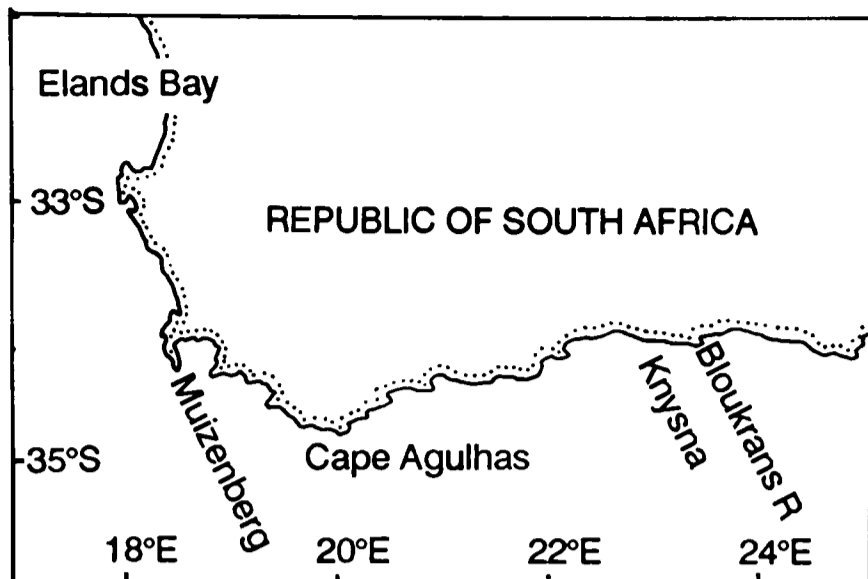

Fig. 1. Map of southern Africa, showing localities mentioned in the text.

MATERIALS AND METHODS

Fieldwork

Since 1979, helicopter surveys for photography of right whales have been flown annually along the southern coast of South Africa (Fig. 1), usually between Muizenberg (18°28'E) and Knysna (23°03'E), but extending occasionally as far as Bloukrans River (23°39'E) to the east and Elands Bay (32°18'S) on the west coast (see Best (in press, Table 1) for details of flights). The extent of the surveys was determined by the distribution of cow-calf pairs seen on a fixed-wing survey about 10 days previously. The timing of the flights was as consistent as possible (ranging from 6 to 23 October) and attempts were made to limit flying to optimal weather conditions (surface wind 8 m/s or less, cloud base >305m and cloud cover <5/8). The entire coastline within the survey area was searched from an altitude of 305m and at a speed of about 50 m/s. The flight path of the aircraft averaged 0.61km offshore and one observer (besides the pilot) searched each side of the flight path.

Before photography, each group seen was circled to establish if a calf was present. If one was detected, the helicopter would descend to about 91m to photograph the calf and accompanying adult(s). If no calf was present the searching pattern would be resumed. All photographs were taken through the open door of the aircraft using (for all but four cow-calf pairs) a hand-held 70mm camera plus motor-drive and 250mm lens, and *Ektachrome* 200 ASA film. The entire film (approx. 12 exposures) would be taken of each cow-calf pair. Three standard views of each animal were attempted; two near-vertical views of the head region, one just before the whale surfaced and one with the rostrum as 'dry' as possible, and a view of the back of the animal above water to establish the presence or absence of grey or white markings. At the end of 1987, a total of about 5,250 photographs of 435 cow-calf pairs and 36 other individuals photographed off South Africa was on file.

The procedure used in sorting and matching photographs of individual animals has been described by Best (in press). Final matches were only decided after all the original photographs of either animal had been examined and all possible criteria (including those not used in the original sorting procedure) had been checked. As a check on the efficiency of the initial sorting procedure, the file of each year's photographs remaining after matching was compared against all other known individuals, including those with which it had already been compared, before the entry of 'new whales' was accepted.

Statistical analysis

Summary of notation

We make use of the following notation:

h = number of years for which observations were made
 N_i = number of mature females in the population in year i at time of survey, $i=1, \dots, h$

N_i^{\min} and N_i^{\max} = the hypothesized limits to the population size in year i

M_i = number of mature females, marked in previous four years, alive at time of survey in year i

N_i^* = number of mature females due to calve in year i

M_i^* = number of mature females, marked in the previous four years, due to calve in year i

c = annual rate of increase of population of mature females
 s = annual survival probability of mature females

$p_i(n)$ = prior probability that population of mature females is of size n in year i , $n = N_i^{\min} \dots N_i^{\max}$

$p_i^*(n) [= p_i^*(n|c, s)]$ = posterior probability that population of mature females is of size n in year i , $n = N_i^{\min} \dots N_i^{\max}$.

The notation in brackets is used when it is necessary to emphasize that the posterior distribution is conditional on the annual survival probability and rate of increase of mature females

\bar{N}_i = the mean of the posterior distribution in year i

m_i = number of mature females marked in previous four years in the sample examined in year i

u_i = number of unmarked mature females (or animals last observed more than four years ago) in the sample examined in year i

k_i = the number of mature females observed in year i

$l_i(j)$ = number of mature females marked j years prior to year i , and not seen in the intervening years $i-j+1 \dots i-1$, $j=1, 2, 3, 4$

q_j = probability that a female is observed to calve again after j years

q_j^* = proportion of females due to calve again j years after previous calving

$q_i(j)$ = the probability that j females mature, becoming ready to calve for the first time, in year i

r_i = proportion of the mature females due to calve in year i

$[x]$ = the integer closest to x .

Statistical model

The model described here differs from that of Zucchini and Channing (1986) and other capture-recapture models in several important ways. Firstly, we consider only those animals that have been photographed in the four years preceding the current year as 'marked'. The model can thus only be used to make estimates of the population size from the fifth year of sampling onwards. This period was chosen because, although most females calve at three year intervals, some calve after two years and some after four or more years. This restriction also enables us to overcome the difficulties associated with unequal recapture probabilities after different numbers of years because we only need to estimate three of these parameters, the probabilities of returning to calve after two, three and four years. Secondly, we assume that the annual growth and survival probabilities of the population are fixed and known, so that these parameters are not estimated from the capture-recapture data. We do, however, develop a method that indicates the consequences of the uncertainty about these values.

The number of mature females marked over the four years preceding year i , and surviving to year i , is estimated by

$$M_i = [l_i(1)s + l_i(2)s^2 + l_i(3)s^3 + l_i(4)s^4]$$

Because southern right whales do not calve every year (Best, in press), only a proportion of these are due to calve in year i . Southern right whales generally calve at three-year intervals (although some have been observed to calve again after two, and some after four or more years): thus one would expect the proportion of mature females due to calve in year i to be $r_i = 1/3$, so that the number of females due to calve in year i would be $N_i^* = 1/3 N_i$. However, the sizes of the calving cohorts are not equal, a bigger cohort calving at three year intervals (Best, 1990). The fact that some animals change cohorts is a further complication. Thus more refined approximations to r_i and N_i^* are required. We assume that every female is due to calve once in every three year period, either two, three or four years after previously calving. We let the probabilities of being observed to calve again after two, three and four years be q_j , $j=2,3,4$, respectively. A proportion of those females which calved in year i will fail to be observed with calves in year $i+2$, $i+3$ or $i+4$: the female might have died in the intervening period or had a miscarriage, the calf may have been stillborn or died soon after birth, calving may have occurred after the survey period or outside the survey area, or the female and calf might have been present but overflowed during the survey. However, we assume that the q_j reflect the true ratios of being due to calve again after two, three or four years (the animals recorded on longer intervals being assumed to have had an unrecorded calf in the interim). We therefore rescale them so that they add to 1:

$$q_j^* = q_j / \sum_{j=2}^4 q_j$$

so that q_j^* is the proportion of females that last calved j years ago that is due to calve in the current year. Thus the number of females, marked in the previous four years and due to calve in year i , is given by

$$M_i^* = [\sum_{j=2}^4 q_j^* k_{i-j}]$$

The proportion of mature females due to calve in year i is thus the ratio of the mature females, marked over the previous four years, and due to calve in year i , to the total number of mature females marked over the previous four years, and surviving to year i : $r_i = M_i^*/M_i$. The number of females (both marked and unmarked) due to calve in year i is thus $N_i^* = [r_i N_i]$, because marked and unmarked animals are assumed to reproduce in the same way.

Let $P_i(n)$ be the (prior) probability that $N_i = n$ before the i th sample has been processed. Sample i consists of m_i marked (in the previous four years) and u_i unmarked mature females. We consider this to be the result of selecting at random from the M_i^* marked and $[r_i N_i] - M_i^*$ unmarked females due to calve in year i . By Bayes' theorem, the posterior probability that $N_i = n$ is given by

$$p_i^*(n) = kH(M_i^*, U_i^*, m_i, u_i)p_i(n)$$

where

$$1/k = \sum_{j=N_i^{\min}}^{N_i^{\max}} H(M_i^*, U_j^*, m_i, u_i)p_i(j)$$

with $U_j^* = j - M_i^*$ and where

$$H(A, B, a, b) = \frac{A!B!}{a!(A-a)!b!(B-b)!} \frac{(a+b)!(A+B-(a+b))!}{(A+B)!}$$

for $0 \leq a \leq A$, $0 \leq b \leq B$, the hypergeometric distribution (Zucchini and Channing, 1986).

To start the iterative procedure, it is necessary to assign values to N_i^{\min} and N_i^{\max} , the hypothesized limits to the population size in year 1, and to $p_1(n)$, the initial prior distribution. In choosing these values, the researcher may make use of his experience and intuitive feeling of the initial population size. In this application, we chose the minimum limit to the population size in the initial year by taking into account the number of marked animals, chose an improbable upper bound as the maximum, and assigned probabilities using the triangular distribution. As pointed out by Zucchini and Channing (1986), the method only fails if the prior distribution assigns zero probability to the actual population size. However, the closer the initial prior distribution is to reality, the less its distortion of successive posterior distributions.

Next, the annual growth in the population needs to be taken into account. This was done in two ways. Firstly, by computing the mean

$$\bar{N}_i = \sum_{j=N_i^{\min}}^{N_i^{\max}} j p^*(j)$$

of the posterior distribution in year i , estimating the number of females ready to calve for the first time in the following calving season, $a_i = c\bar{N}_i$, and translating the posterior distribution by this amount to form the prior distribution for year $i+1$: $p_{i+1}(n+a_i) = p_i^*(n)$, the population limits in year $i+1$ becoming $N_{i+1}^{\min} = N_i^{\min} + a_i$; and $N_{i+1}^{\max} = N_i^{\max} + a_i$. Secondly, the number of females ready to calve for the first time in year $i+1$ was considered to be a random variable with mean a_i , as defined above. In the absence of any information on the possible distribution of this random variable, the binomial distribution $\text{Bin}(2a_i, 1/2)$ was chosen: this distribution has the required mean and allows the number of maturing females to vary in the range 0 to $2a_i$, with values near the mean being more likely. This distribution was convoluted with the posterior distribution for year i to yield the posterior distribution for year $i+1$:

$$p_{i+1}(n) = \sum_{j=0}^{2a_i} \binom{2a_i}{j} \left(\frac{1}{2}\right)^{2a_i} p_i^*(n-j)$$

Provided that the distortion introduced by the initial prior distribution has been eradicated, the annual growth rate can be estimated for each year by $100(N_{i+1} - N_i)/N_i\%$. These values, computed from the posterior distributions, can be compared with c , the hypothesized growth rate.

Summary statistics for the population size in each year, such as the mean, median, quartiles and the 95% confidence intervals, can easily be computed from the posterior probability distributions.

Finally, by assigning probabilities to the plausible values of the annual growth rates and survival probabilities, it is possible to combine the posterior probability distributions for the fixed values of these parameters to produce a crude overall posterior distribution. It is now convenient to denote the posterior distribution in the final year (h) by $P_h^*(n|c, s)$, to emphasize that it is conditional on the chosen values for c and s . Suppose that the range of plausible values for c and s are split into J and K mutually exclusive intervals respectively, with c_j , $j=1,2,\dots,J$ and s_k , $k=1,2,\dots,K$ being representative values (usually midpoints) from each interval. Let $p(c_j)$ and $p(s_k)$ be the estimated probabilities that the annual rate of increase and the survival probability fall into the intervals represented by c_j and s_k respectively.

Then, assuming annual rate of increase and survival probability are independent, an overall posterior probability distribution for year h is given by

$$p_h^o(n) = \sum_{j=1}^J \sum_{k=1}^K p_h^*(n|c_j, s_k) p(c_j) p(s_k). \quad (1)$$

Summary statistics can also be computed from this overall posterior distribution.

RESULTS

In order to apply the method, it is necessary to assign values to the parameters c , s and q_j .

The annual increase rate for the population of mature females (c) was estimated from counts of cow-calf pairs made on fixed wing aerial surveys along a standard section of the coast that included the area later searched by helicopter during aerial photography. The methodology used in these surveys has been described by Best (1981). The rate of increase from 1971 to 1987 has been exponential, at an annual rate of 6.8% (95% confidence interval 4.6% to 9.0%) both from the counts themselves and from the counts expressed as number seen per flying hour (Best, 1990). Values for c of 4.6%, 5.7%, 6.8%, 7.9% and 9.0% were used in the model.

The likely range of annual survival rates for adult female right whales of 0.95–0.98 has been based on the argument that a population increase rate of 6–7% is not maintainable if annual adult survival rates average much less than 0.95 (Best, in press), while a survival rate higher than 0.98 corresponds to an average age in the population of more than 50 years, which seems unreasonably large. Values for s of 0.95, 0.96, 0.97 and 0.98 were used in the model.

In determining minimum and maximum limits to the population size in the initial year (1983), we were guided by the fact that 130 females had already been individually identified by the end of the 1982 season (Table 1), and that about 60% of the animals marked in 1979 were rephotographed in 1982. We considered 180 and 250

therefore to be reasonable lower and upper limits to the population size in 1983. These values were used to start the iterative procedure. To examine the sensitivity of the method to these starting values, we also report results using assumed population limits for 1983 of 140 and 300. The probabilities that animals return to calve after one, two, three and four years are estimated to be $q_1=0.0$, $q_2=0.026$, $q_3=0.560$ and $q_4=0.043$ respectively (Table 2).

The numbers of mature females, marked and unmarked, in each sample, and the numbers of mature females last seen one, two, three and four years ago, are given in Table 3. From these data, the Bayesian estimates of the population size at the time of the 1987 sample have been computed, for the two methods of implementing the population growth (translation and convolution), for the two pairs of assumed limits of the initial population size, and for a range of values for survival rate and population increase (Tables 4–7). For the best available point estimates of survival rate and population increase of $s=0.97$ and $c=6.8\%$ respectively (and with the translation method of implementing population growth and initial limits on the population size of 180 and 250) the mean and median of the probability distribution for the population size of mature females in 1987 were 289 and 288 respectively with the 95% confidence interval being (278, 301) (Table 4). For the other methods, the point estimates and confidence intervals corresponding to these estimates of survival rate and population growth were very similar (Tables 5, 6 and 7), the widest 95% confidence interval being (274, 304), when the convolution method of implementing population growth and initial limits of population size of 140 and 300 were used (Table 7).

Table 1

Number of mature females observed each year¹.

1979	1980	1981	1982	1983	1984	1985	1986	1987
Number observed k_i								
27	34	47	40	42	65	50	44	76
Cumulative number marked								
27	61	107	130	147	176	196	210	229

¹ Excludes seven females photographed outside standard area.

Table 2

Probabilities that mature females return to calve after one, two, three and four years.

Years to return	Sample size	Number returning	Prob., q_j , of returning	95% confidence limits	Propn., q_j^* , returning
1	318	0			
2	304	8	0.026	(0.008,0.044)	0.041
3	284	159	0.560	(0.502,0.618)	0.890
4	255	11	0.043	(0.018,0.068)	0.068

Table 3

Numbers of marked and unmarked in each sample, 1983 to 1987, and the numbers of mature females marked one, two, three and four years previously and not seen subsequently.

Year	Unmarked	Marked	Last seen one to four years previously			
	u_i	m_i	$l_i(1)$	$l_i(2)$	$l_i(3)$	$l_i(4)$
1983	17	25	40	47	34	6
1984	32	33	42	40	47	10
1985	21	29	65	42	40	16
1986	19	25	50	65	42	9
1987	28	48	44	50	65	13

Table 4

Means, medians and 95% confidence intervals for size of the population of mature female southern right whales in 1987 for survival probabilities between 0.95 and 0.98, and population growth rates between 4.6% and 9.0%. Population growth implemented by translating the posterior distribution to form the next prior distribution. Limits of initial population size taken as 180 and 250.

	4.6%	5.7%	6.8%	7.9%	9.0%
0.95	264 262 (253,276)	271 269 (260,283)	277 276 (267,290)	285 284 (275,297)	292 291 (283,304)
0.96	270 268 (259,281)	276 275 (266,288)	284 282 (273,296)	291 289 (281,303)	300 298 (289,312)
0.97	275 274 (264,285)	281 280 (270,292)	289 288 (278,301)	298 297 (287,310)	305 304 (294,317)
0.98	279 278 (269,288)	286 285 (275,296)	295 293 (284,306)	303 302 (292,315)	312 311 (302,325)

Table 5

Means, medians and 95% confidence intervals for size of the population of mature female southern right whales in 1987 for survival probabilities between 0.95 and 0.98, and population growth rates between 4.6% and 9.0%. Population growth implemented by convoluting the posterior distribution to form the next prior distribution. Limits of initial population size taken as 180 and 250.

	4.6%	5.7%	6.8%	7.9%	9.0%
0.95	263 262 (251,276)	272 270 (259,287)	277 276 (263,291)	283 281 (269,297)	290 288 (275,305)
0.96	269 268 (257,282)	277 275 (264,293)	282 281 (268,296)	288 287 (274,303)	296 295 (282,312)
0.97	274 273 (262,286)	282 280 (269,297)	287 286 (273,301)	295 294 (281,310)	302 300 (287,317)
0.98	278 277 (266,290)	286 285 (273,300)	293 292 (279,307)	301 299 (286,316)	309 308 (294,325)

Table 6

Means, medians and 95% confidence intervals for size of the population of mature female southern right whales in 1987 for survival probabilities between 0.95 and 0.98, and population growth rates between 4.6% and 9.0%. Population growth implemented by translating the posterior distribution to form the next prior distribution. Limits of initial population size taken as 140 and 300.

	4.6%	5.7%	6.8%	7.9%	9.0%
0.95	265 263 (253,278)	272 271 (261,285)	279 278 (268,292)	287 285 (276,299)	294 293 (283,307)
0.96	271 270 (260,285)	278 276 (267,291)	285 283 (274,298)	292 290 (281,305)	301 299 (289,314)
0.97	277 275 (265,290)	283 282 (271,297)	290 289 (278,304)	299 298 (287,312)	309 307 (297,322)
0.98	283 281 (271,297)	291 289 (278,304)	298 296 (286,312)	305 303 (293,318)	314 312 (302,327)

Table 7

Means, medians and 95% confidence intervals for size of the population of mature female southern right whales in 1987 for survival probabilities between 0.95 and 0.98, and population growth rates between 4.6% and 9.0%. Population growth implemented by convoluting the posterior distribution to form the next prior distribution. Limits of initial population size taken as 140 and 300.

	4.6%	5.7%	6.8%	7.9%	9.0%
0.95	264 263 (251,278)	271 270 (258,286)	277 276 (263,292)	284 283 (269,299)	291 290 (276,306)
0.96	271 269 (258,285)	276 275 (263,291)	283 282 (269,298)	290 288 (275,305)	297 296 (282,313)
0.97	277 275 (264,291)	282 280 (268,297)	288 287 (274,304)	296 295 (281,312)	305 303 (289,321)
0.98	283 281 (269,298)	289 288 (275,305)	296 295 (281,312)	303 301 (288,319)	311 309 (295,327)

These estimates are relatively insensitive to the relatively large range of survival and population increase rates considered: in Table 4, for example, the estimate of the median population size varies between 262 (survival rate 0.95 and population increase 4.6%) and 311 (survival rate 0.98 and population increase 9.0%), a relative difference of 17%.

Fig. 2 shows how the 95% confidence intervals have changed over the five-year period: note how the confidence intervals decrease in width with each successive

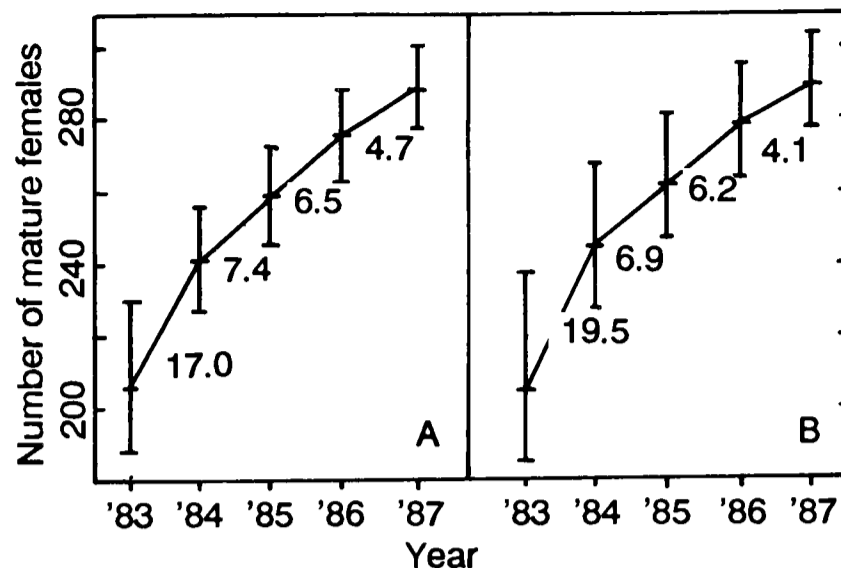

Fig. 2. Successive means and 95% confidence intervals for the population size of mature female southern right whales along the southern coast of South Africa from 1983 to 1987, for initial estimates of the population size of 180 to 250 (A) and 140 to 300 (B) respectively. The iterative procedure was used, with the best available point estimates for survival rate of 0.97 and population increase of 6.8%. The population growth rates estimated are also shown between successive annual means as percentages.

year, and how the effects of the initial assumptions about the population size are rapidly eliminated. Successive increases in the mean population size show a monotonically decreasing trend (Fig. 2).

To compute the approximate overall posterior distribution it is necessary to assign probabilities to the representative values of the annual growth rate and survival probabilities. For the annual growth rate, the probabilities have been assigned assuming a normal distribution with mean 6.8 and standard deviation 1.0 (Table 8). No estimates of the survival probabilities are available, and three assignments of the associated probabilities have been made (Table 9). The summary statistics computed from the overall posterior distributions based on the assumptions about initial population limits and methods of implementing the population increase were all similar (Table 10), as were the summary statistics computed from the three assignments of probabilities to the various values of the survival probability (Table 10). A reasonable point estimate of the population size is 286, and an approximate 95% confidence interval, taking into account the uncertainty of *c* and *s*, is (265, 310).

Table 8

Probabilities assigned to intervals of the range of plausible values for the annual rate of population growth *c*.

Intervals	<5.15	5.15-6.25	6.25-7.35	7.35-8.45	>8.45
Representative values	4.6%	5.7%	6.8%	7.9%	9.0%
Probabilities	0.06	0.23	0.42	0.23	0.06

Table 9

Probabilities assigned to intervals of the range of plausible values for the annual survival probability *s*.

Intervals	<0.955	0.955-0.965	0.965-0.975	>0.975
Representative values	0.95	0.96	0.97	0.98
Probabilities (assign. 1)	0.1667	0.3333	0.3333	0.1667
(assign. 2)	0.25	0.25	0.25	0.25
(assign. 3)	0.1	0.3	0.3	0.3

Table 10

Means, medians and 95% confidence intervals for size of population of mature female southern right whales in 1987 based on overall posterior distribution. The method of assigning survival probabilities (A in the Table) refers to Table 9.

Population growth method	Initial limits	A	Mean	Mode	95%CI
translation	(180,250)	1	286	284	(266,308)
convolution	(180,250)	1	285	286	(264,307)
translation	(140,300)	1	288	284	(267,311)
convolution	(140,300)	1	286	286	(265,310)
translation	(180,250)	2	286	284	(265,309)
translation	(180,250)	3	288	289	(267,310)

DISCUSSION

Hammond (1986) reviewed the use of mark-recapture techniques for estimating the size of naturally marked whale populations. He concluded that there are three major issues that need to be addressed in assessing the applicability of mark-recapture methods to whale populations. We state these issues, and consider them in relation to the method presented here. Firstly, the population being studied must be clearly defined. We have limited ourselves to a well defined component of the population: mature females of the southern right whale population that calves off the southern coast of South Africa. Secondly, the samples must be representative of the population being sampled. The fieldwork methods attempted to ensure this, the helicopter surveys covering the known range of 90% of cows with calves on the South African coast (Best, 1990), at a time of year when calving is believed to be virtually complete (Best, 1981). Thirdly, sample sizes must be sufficiently large to obtain precise estimates of population size. The percentage of marked (in the sense of having been photographed in the preceding four years) animals in the samples in the years between 1983 and 1987 ranged from 50.8% to 63.2% (Table 3), indicating that a high proportion of the population had been sampled.

The method used in this paper depends on the correct classification of all whales as marked (previously photographed) or new animals. Mistakes can be of two kinds: an incorrect identification of a match (type 1 error) or a failure to recognise a match (type 2 error). Hammond (1986) estimated, based on information given by Payne *et al.* (1983) that, given the theoretical number of callosity patterns in a population of 10,000 southern right whales, the probability of finding an exact duplicate was 0.5×10^{-6} . Thus the probability of a type 1 error in the small population of southern right whales visiting South Africa is insignificant.

In a cross check of the photographs of 247 animals taken between 1978 and 1986, PBB found two additional matches (0.8%). At this rate, examining about 60 animals per year, a previously photographed animal would be classified as new on average about once in two years. The consequence of type 2 errors is to increase the estimated population size. This is demonstrated by increasing the number of marked animals in Table 3 by one (and similarly decreasing the number of unmarked animals) in 1983, 1985 and 1987. The mean and mode become 285.7 and 284 respectively, and the 95% confidence limits (275, 297) (with $c=6.8\%$, $s=0.97$, the translation method for population growth and

initial limits of 180 to 250), compared to a mean and mode of 289.0 and 288, and a 95% confidence interval of (278, 301) with the observed data (Table 4). Misclassification is clearly more likely the longer the period that elapses before an animal is rephotographed, because the size and shape of the callosities can change with time. The method developed in this paper considers only those animals photographed in the preceding four years as marked. We therefore believe that misclassifications would not occur more frequently than once in two years with present sample sizes, and that, although the effect is to overestimate the population size, the resultant bias is small.

Whitehead *et al.* (1986) have attempted to use the standard Jolly-Seber mark-recapture model (Jolly, 1965; Seber, 1965) to estimate the size of a population of southern right whales off Peninsula Valdes, Argentina, from natural markings. In their population they considered that the assumptions of the Jolly-Seber method were approximately satisfied. In particular, they found using Leslie's test of equal catchability (Orlans, 1958; see also Seber, 1982, pp.161-2 and 262-8) that the primary assumption of the Jolly-Seber method (that all animals had the same probability of being observed each year) was satisfied for known females. It is hard to see how this could have been true, for Payne (1986) stated that only 15.6% of adult females were observed off Argentina in the year preceding that in which they calved. Leslie's test of equal catchability is notoriously weak at detecting departure from the null hypothesis of equal catchability (Carothers, 1973). In fact, Hammond (1986) concluded that obtaining representative samples from this population is a nontrivial task.

In the population off the southern coast of South Africa, this primary assumption of the Jolly-Seber model was clearly violated. However, we do assume that the marked and unmarked mature females calving in any given year have equal probabilities of being observed.

By the end of the 1987 season, a total of 236 individually identified mature females was on file for the southern African population. Allowing for natural mortality (at the likely rates of between 0.02-0.05 per year) since first being photographed this indicates a population in 1987 of between 188 and 215 known mature females. The percentage of marked (in the sense of having been observed in any preceding year) whales encountered during the last three calving seasons ranged from 60% to 75%. Furthermore, the section of coast sampled each year encompassed the distribution of about 90% of the cows with calves on the entire coastline of South Africa at this time of year. Intuitively, therefore, the population estimates obtained in this paper appear reasonable.

The method of generating the overall posterior probability distribution is approximate. Firstly, the variables c and s are unlikely to be independent, as assumed in equation (1). Secondly, the overall posterior probability distribution should be computed by integrating over the joint probability density function for c and s , rather than a summation over a crude histogram approximation. However, we have no information on the form of the joint distribution of these two variables, and a more sophisticated analysis than that presented here is not justified. Note also that the overall posterior probability distribution is conditional on the values for q_j^* of Table 2. A fully unconditional posterior distribution would need to take into account the uncertainty in these values.

The annual population growth rates, as estimated from the posterior distributions, are close to the point estimate of 6.8% in 1985 and 1986 (Fig. 2). The large apparent increase in 1984 is due to the below average percentage of marked (in the sense of not having been seen in the previous four years) whales in this year, 51%, and the small apparent increase in 1987 is due to the above average percentage of marked whales in this year, 63% (Table 3). Note that these above and below average increases, being three years apart, both refer to a single cohort. The fact that the four successive percentage increases in estimated population size are monotonically decreasing cannot, at this stage, be taken as indicative that the rate of increase for this population of southern right whales is decreasing. Continuation of the photographic sampling programme will enable more precise estimates of population size and of the annual growth and survival rates to be made.

ACKNOWLEDGEMENTS

LGU acknowledges support from the Foundation for Research Development of the Council for Scientific and Industrial Research. Financial support for PBB was provided by the South African Department of Environment Affairs via the South African Scientific Committee for Antarctic Research. W. Zucchini and D. Miller commented on a draft, and the referees made valuable suggestions for improvements.

REFERENCES

- Bannister, J.L. 1986a. Southern right whales: status off Australia from twentieth-century 'incidental' sightings and aerial survey. *Rep. int. Whal. Commn* (special issue 10): 153-8.
- Bannister, J.L. 1986b. Notes on nineteenth century catches of southern right whales (*Eubalaena australis*) off the southern coasts of western Australia. *Rep. int. Whal. Commn* (special issue 10): 255-9.
- Best, P.B. 1981. The status of right whales (*Eubalaena glacialis*) off South Africa, 1969-1979. *Investl Rep. Sea Fish Inst. S. Afr.* 123:1-44.
- Best, P.B. 1990. Trends in the inshore right whale population off South Africa, 1969-1987. *Mar. Mammal Sci.* 6:93-108.
- Best, P.B. in press. Natural markings and their use in determining calving intervals in right whales off South Africa. *S. Afr. J. Zool.*
- Carothers, A.D. 1973. Capture-recapture methods applied to a population with known parameters. *J. Anim. Ecol.* 42:125-46.
- Gazey, W.J. and Staley, M.J. 1986. Population estimation from mark-recapture experiments using a sequential Bayes algorithm. *Ecology* 67:941-51.
- Hammond, P.S. 1986. Estimating the size of naturally marked whale populations using capture-recapture techniques. *Rep. int. Whal. Commn* (special issue 8): 253-82.
- Jolly, G.M. 1965. Explicit estimates from capture-recapture data with both death and immigration - stochastic model. *Biometrika* 52:225-47.
- Orians, G.H. 1958. A capture-recapture analysis of a shearwater population. *J. Anim. Ecol.* 27: 71-84.
- Payne, R. 1986. Long term behavioural studies of the southern right whale (*Eubalaena australis*). *Rep. int. Whal. Commn* (special issue 10): 161-7.
- Payne, R., Brazier, O., Dorsey, E.M., Perkins, J.S., Rowntree, V.J. and Titus, A. 1983. External features in southern right whales (*Eubalaena australis*) and their use in identifying individuals. pp. 371-445. In: Payne, R. (ed.) *Communication and Behavior of Whales*. AAAS Selected Symposium Series 76. Westview Press, Inc., Boulder, Colorado.
- Raftery, A.E., Turet, P. and Zeh, J.E. 1988. A parametric empirical Bayes approach to interval estimation of bowhead whale, *Balaena mysticetus*, population size. *Rep. int. Whal. Commn* 38:377-88.
- Seber, G.A.F. 1965. A note on the multiple recapture census. *Biometrika* 52: 249-59.
- Seber, G.A.F. 1982. *The Estimation of Animal Abundance and Related Parameters*, 2nd Ed. Griffin, London. i-xvii + 654pp.
- Whitehead, H., Payne, R. and Payne, M. 1986. Population estimate for the right whales off Peninsula Valdes, Argentina, 1971-1976. *Rep. int. Whal. Commn* (special issue 10): 169-71.
- Zucchini, W. and Channing, A. 1986. Bayesian estimation of animal abundance in small populations using capture-recapture information. *S. Afr. J. Sci.* 82: 137-40.

A Note on the Stock Size of Humpback Whales Along the Pacific Coast of Mexico

Carlos Alvarez¹, Anelio Aguayo¹, Raúl Rueda² and Jorge Urbán^{1*}

ABSTRACT

Photo-identification data were collected from humpback whales in the waters off Isla Isabel in the winter seasons of 1984–5 and 1985–6. Twenty-two whales were identified in the first season and 73 in the second, with four recaptures. Estimates of humpback population size off the Pacific coast of Mexico were obtained using the Chapman and Bailey modifications of the Petersen mark-recapture method, the binomial distribution and the rate of discovery of new whales. 95% Monte Carlo confidence intervals were obtained. Estimates with confidence limits were: with the Chapman method, 339 (188,886); with the Bailey method, 325 (180,839); with the binomial distribution 285 (166,505); and with the rate of discovery 288 (189,678). It is thought that the values obtained are underestimates of the population size.

INTRODUCTION

Photo-identification techniques have proved to be a reliable method of recognising individuals of several cetacean species such as the humpback whale (*Megaptera novaeangliae*) allowing behavioural and other studies to be conducted (see Katona, Baxter, Brazier, Kraus, Perkins and Whitehead, 1979; Whitehead, 1981; Darling, 1983; Glockner and Venus, 1983; Payne, Brazier, Dorsey, Perkins, Rowntree and Titus, 1983).

Photo-identification studies on humpback whales in Mexican waters have been carried out by researchers from the National University of México (UNAM) since 1982 with approximately 350 whales identified. This research has led to a better knowledge of the distribution of humpbacks in Mexican waters (Aguayo, Urbán and Salinas, 1985; Urbán and Aguayo, 1987) and better data to address the proposed migratory connection between the coast of Mexico and central California (Urbán, Balcomb, Alvarez, Bloedel, Cabbage, Calambokidis, Steiger and Aguayo, 1987; 1988). Attempts to obtain an estimate of the population size were also initiated (Alvarez, 1987). Initially, the main objective of the present study was to obtain such an estimate. However, as we went further in the analytical process we had problems in finding the solution of two of the estimators used and with the subsequent calculation of confidence intervals based on all the methods applied; hence the present paper addresses the advances we have made with respect to abundance estimation.

From sightings of humpback whales, Urbán and Aguayo (1987) proposed that the waters off the Pacific coast of Mexico can be divided as follows: (1) the southern coast of Baja California; (2) the northern Gulf of California; (3) the coastal waters of the Mexican mainland from Mazatlán in the north to at least Tehuantepec in the south and the waters of Isla Isabel, the Islas Tres Mariás and Bahía de Banderas; and (4) the waters of the Revillagigedo Archipelago. Following Urbán *et al.* (1987), it is possible to

consider that the humpbacks occupying subregions 1 and 3 belong to a stock isolated to a high degree from the whales that assemble in Revillagigedo (Fig. 1).

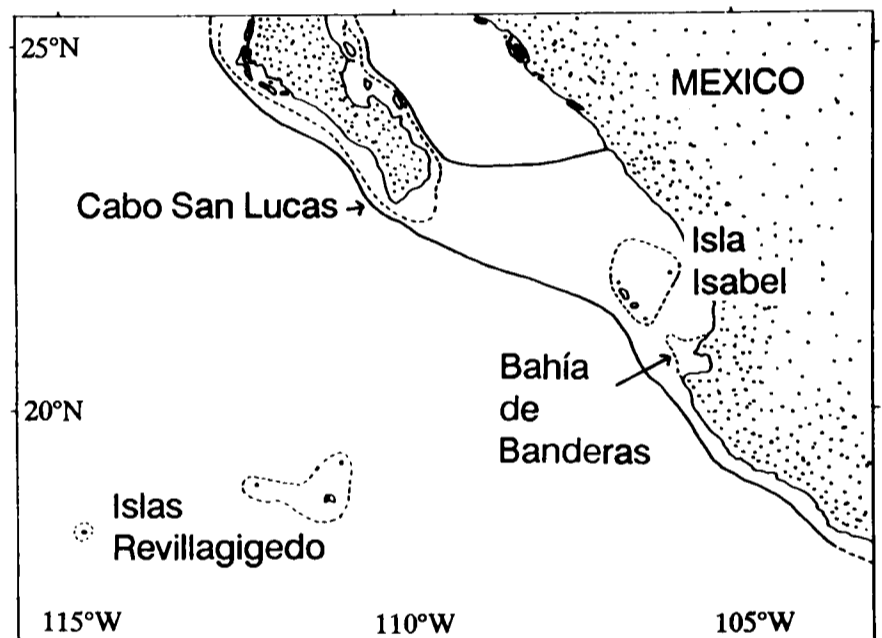

Fig. 1. Study area and main gathering places off the Pacific coast of Mexico (after Urbán and Aguayo, 1987) indicated by dotted lines. The approximate area occupied by the stock of Mexico is delimited by continuous lines.

METHODS

Field methods

Data used for this work were collected in the waters off Isla Isabel in late December 1984 and early January 1985, and in January and February of 1986.

Photographs of the underside of the humpback flukes were obtained from a 7m fiberglass boat, using 35mm cameras with lenses up to 200mm. A variety of black and white and colour films were used, usually Plus-X Pan pushed to 200 ISO with normal high contrast development. Searching took place up to 15 n.miles from the island.

Estimation methods

Chapman (1951) and Bailey (1951) described Petersen mark-recapture estimators modified to minimise small sample bias. These two models were applied to the data using whales identified in the 1984–85 season as the first sample and whales identified in the 1986 season as the second sample. Seber (1982) gives a summary of the derivation of these estimators. The data collected in 1986

¹ Facultad de Ciencias, Universidad Nacional Autónoma de México (UNAM), Apdo. Postal 70–400, C.P. 04510, México D.F., México.

² Instituto de Investigaciones en Matemáticas Aplicadas y en Sistemas, Universidad Nacional Autónoma de México (UNAM), Apdo. Postal 20–726, C.P. 01000, México D.F., México.

* Current address: Departamento de Biología Marina, Área de Ciencias del Mar, Universidad Autónoma de Baja California Sur, Apdo. Postal 219-B, C.P. 23000, La Paz, B.C.S., México.

were used to estimate population size by two additional methods; fitting models describing the binomial distribution and the rate of discovery of new whales (Darling and Morowitz, 1986). Under the binomial distribution, the expected number, X_i of whales which would be identified i times if a random sample of n animals were photographed from a total population of N whales is:

$$X_i = \frac{Nn!}{(n-i)!i!} \left(\frac{1}{N}\right)^{i-1} \left(1 - \frac{1}{N}\right)^{n-i}$$

We used the 'minimum chi-squared' method (e.g. Mood, Graybill and Boes, 1974) to fit the Bernoulli distribution to the observed data, which entails searching for the value of N which minimises the expression:

$$T = \sum [(x_i - X_i)^2 / X_i]$$

where x_i is the number of whales observed i times as predicted by the model. To find the N value that minimizes T , the solution for equation 1 was first obtained for the case in which $i=1$, as a first approximation. Next, two extreme numbers are taken each side of the first N ; these values were chosen, beyond which, common sense dictates that N could not be. The estimate (N) of the population size is the N value from the interval that gives the smallest T . This is also helpful to test if there is a significant fraction of the population that was seen more than expected under the model assumptions.

Following Darling and Morowitz (1986), the rate of discovery of new whales can be modelled with the expression

$$y = N[1 - (1 - 1/N)^x]$$

where y is the number of new whales photoidentified in x observations. The root of this function was found using an iterative method.

The confidence intervals for the Bailey and Chapman estimates can be obtained by assuming that N is normally distributed, given that they are based on a maximum likelihood estimator of N (Seber, 1982). However, this was not the case for the estimates of N using the binomial distribution nor for the rate of discovery of new whales. Program MONTE (Buckland, 1985) was used to obtain Monte Carlo 95% confidence limits for all the obtained estimates. The sample of estimates of N required in MONTE was generated by applying nonparametric bootstrap methods. A total of 5,000 observations of N were generated and percentile limits were selected.

RESULTS AND DISCUSSION

During the first season (1984-5), 22 whales were photoidentified, and in the second season (1985-6), 73 humpbacks were photographically identified. Of the whales observed within the second sample, four had been sighted in the first one. During the second season, 63 whales were seen on a single day, 9 on two days and 1 was seen on three different days.

The estimates shown in Table 1 refer to a population which we consider to be geographically closed. This assumption is based on several observations. In different years, several whales have been observed repeatedly in different places off the coast of Mexico: such as Isla Isabel, Bahía de Banderas and the south of Baja California (Alvarez, 1987; unpublished data). By contrast, no matches have been found between the whales of the

Mexican coast and animals wintering in either the Revillagigedo or in the Hawaiian Islands. In addition, no matches have been found when comparing whales seen in these wintering areas with those feeding in central California. This latter area has been shown to be the main migratory destination in summer for the humpbacks breeding off the coast of Mexico (Urbán *et al.*, 1987; 1988). Hence we assume that these whales will return regularly to this breeding ground with little, if any exchange with other populations. However, a fraction of the group might not have arrived at the first stage of the season due to pulse migration, so it is unlikely that all the whales were present during each sampling period. In addition, we assume that recruitment was sufficiently small that it will not have a large effect on the estimates, and that the latter will be valid for the time of the first sampling.

Table 1

Estimates of population size for the whales wintering off the Pacific coast of Mexico.

Method	N	95% Confidence intervals (percentile method)
Binomial distribution	285	166,505
Rate of discovery of new whales	288	189,678
Bailey estimator	325	180,839
Chapman estimator	339	188,886

Humpback whales move freely along the coast in this breeding ground and there is no physical or biological evidence to suggest there is any tendency for the whales to remain in any particular area. In a test to compare the number of whales observed i times ($i = 1, 2, 3 \dots$) with that expected from the binomial distribution, no significant difference was found ($T=0.0198$, 2df). Therefore, we assume that any whale on the breeding grounds off the coast of Mexico can be observed randomly at any location within them.

Given that the data for this work were collected only in Isla Isabel, an undetermined fraction of the stock was not subject to sampling. Therefore it cannot be assumed that the estimates obtained correspond to the size of the whole stock along the coast of Mexico. We believe that they should be considered to be underestimates of it, rather than as estimates of the number of whales transiting through an area adjacent to Isla Isabel, as suggested by Alvarez (1987).

Hammond (1986) has stated that the binomial distribution model is not appropriate for whale populations because 'a population cannot possibly mix completely between the taking of successive photographs'. This is strictly true when replacement is done with each photograph. Hammond proposes that the use of 'the Schnabel estimator or one of Otis *et al.*'s (1978) models' can be an alternative if data are divided into units of time such as 'day's work'. However, we believe that if the design is such that the sample time allows better mixing, the binomial distribution can explain fairly well some data sets such as that presented here. As shown in Fig. 2, the observed rate of discovery follows the trend explained by the model proposed by Darling and Morowitz (1986) and

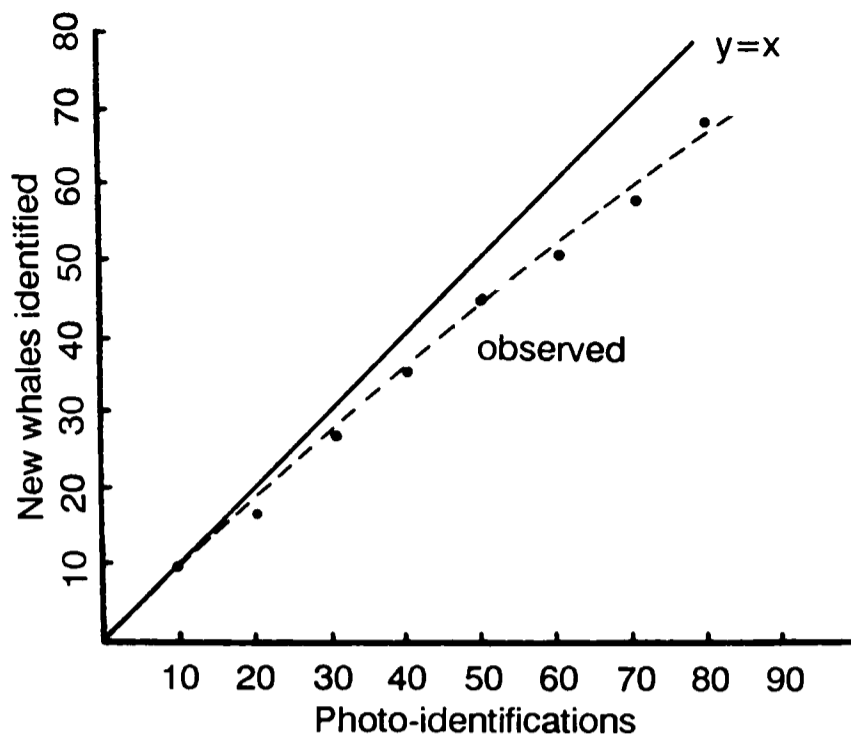

Fig. 2. Rate of discovery of new whales observed in the 1985-6 season.

the estimate of N was 288 whales. This number is very similar to that obtained (285) from using the binomial distribution; this is possibly due to similar modelling. These values are slightly lower than the estimates obtained from the Chapman (339) and Bailey (325) estimators.

Suggestions for future research

As a result of the work done to date, it is clear that complete sampling effort using photo-identification in the summer ground of Central California as the first 'capture' and in the coast of Mexico as the 'recapture', will yield a better estimate of the size of this stock. The use of the Bailey and Chapman modifications is recommended as the best way to estimate the stock size. The use of other models such as the binomial distribution and the rate of discovery of new whales can be instructive and it may be worthwhile performing simulations to find a better way to obtain estimates of population size. It would also be desirable to perform simulations to explore alternatives to estimating confidence intervals.

ACKNOWLEDGEMENTS

Permits to work at Isla Isabel as well as logistic support were provided by Secretaría de Desarrollo Urbano y Ecología (SEDUE). Grant no. 51778 was awarded to C. Alvarez by Consejo Nacional de Ciencia y Tecnología (CONACYT). Logistic support was also provided by the Escuela Superior de Ingeniería Pesquera de Nayarit (ESPIE) and Secretaría de Marina. Colleagues at the Facultad de Ciencias, UNAM, contributed much to the field work. Steve Buckland provided valuable suggestions for the calculation of confidence limits and two anonymous reviewers made helpful comments on the manuscript.

REFERENCES

- Aguayo, A., Urbán, J. and Salinas, M. 1985. El rorcual jorobado (*Megaptera novaeangliae*), durante la estación de reproducción en la Bahía de Banderas, México y su distribución en el Pacífico Mexicano. Doc. 12, pp. 227-51. In: Proceedings IX Reunión Internacional para el Estudio de los Mamíferos Marinos. La Paz, B.C.S., Mexico, March 1984.
- Alvarez, C. 1987. Fotoidentificación del rorcual jorobado, *Megaptera novaeangliae*, en las aguas adyacentes a Isla Isabel, Nay. (Cetacea: Balaenopteridae). Professional Thesis. Universidad Nacional Autónoma de México. 107pp.
- Bailey, N.T.J. 1951. On estimating the size of mobile populations from capture-recapture data. *Biometrika* 38:293-306.
- Buckland, S. 1985. Calculation of Monte Carlo confidence intervals. Statistical algorithms AS214. *Applied Statistics* 34(3): 295-301.
- Chapman, D.G. 1951. Some properties of the hypergeometric distribution with applications to zoological censuses. *Univ. Calif. Public. Stat.* 1:131-60.
- Darling, J. 1983. Migrations, abundance and behavior of Hawaiian humpback whales, *Megaptera novaeangliae* (Borowski). Ph.D Thesis, University of California.
- Darling, J. and Morowitz, H. 1986. Census of 'Hawaiian' humpback whales (*Megaptera novaeangliae*) by individual identification. *Can. J. Zool.* 64: 105-11.
- Glockner, D. and Venus, S. 1983. Identification, growth rates and behavior of humpback whales (*Megaptera novaeangliae*) cows and calves in the waters off Maui, Hawaii, 1977-79. pp. 223-58. In: R. Payne (Ed.) *Communication and Behavior of Whales*. AAAS Selected Symposium 76. Westview Press, Boulder, Colorado, 643pp.
- Hammond, P.S. 1986. Estimating the size of naturally marked whale populations using capture-recapture techniques. *Rep. int. Whal. Commn* (special issue 8): 253-82.
- Katona, S., Baxter, B., Brazier, O., Kraus, S., Perkins, J. and Whitehead, H. 1979. Identification of humpback whales by fluke photographs. pp. 33-44. In: H.E. Winn and B.L. Olla (Eds) *Behavior of Marine Animals, Vol. 3* Plenum Press, New York.
- Mood, A.M., Graybill, F.A. and Boes, D.C. 1974. *Introduction to the Theory of Statistics*. McGraw-Hill, New York.
- Otis, D.L., Burnham, K.P., White, G.C. and Anderson, D.R. 1978. Statistical inference from capture data on closed animal populations. *Wildlife Monographs* No. 62, 135pp.
- Payne, R., Brazier, O., Dorsey, E.M., Perkins, J.S., Rowntree, V.J. and Titus, A. 1983. External features in the southern right whales (*Eubalaena australis*) and their use in identifying individuals. pp. 371-445. In: R. Payne (Ed.) *Communication and Behavior of Whales*. AAAS Selected Symposium 76. Westview Press, Boulder, Colorado. 643pp.
- Seber, G.A.F. 1982. *The Estimation of Animal Abundance and Related Parameters* Griffin, London. 2nd edition, 654pp.
- Urbán, J. and Aguayo, A. 1987. Spatial and seasonal distribution of the humpback whale, *Megaptera novaeangliae*, in the Mexican Pacific. *Mar. Mamm. Sci.* 3(4): 333-44.
- Urbán, J., Balcomb, K.C., Alvarez, C., Bloedel, P., Cabbage, J., Calambokidis, J., Steiger, G. and Aguayo, A. 1987. Photo-identification matches of humpback whales (*Megaptera novaeangliae*) between Mexico and Central California. Presented to the Seventh Conference on the Biology of Marine Mammals, Miami, December 1987 (unpublished).
- Urbán, J., Balcomb, K.C., Alvarez, C., Bloedel, P., Cabbage, J., Calambokidis, J., Steiger, G. and Aguayo, A. 1988. Determinación de los destinos migratorios (México-California Central) de rorcuales jorobados, *Megaptera novaeangliae*, por medio de fotoidentificación. Abstract XII Reunión Internacional sobre el Estudio de los Mamíferos Marinos, La Paz, B.C.S., México. April 1988.
- Whitehead, H. 1981. The behaviour and ecology of the humpback whale in the northwest Atlantic. D.Phil. Thesis, University of Cambridge. 180pp.

Abundance, Distribution and Movements of Bottlenose Dolphins (*Tursiops truncatus*) in Lower Tampa Bay, Florida

Brad Weigle*

University of South Florida, Marine Science Department,
140 7th Avenue Southeast, St. Petersburg, Florida 33701, USA

ABSTRACT

Boat surveys of bottlenose dolphins (*Tursiops truncatus*) inhabiting lower Tampa Bay, Florida, were conducted between April and October in 1983 and 1984. Objectives included: (1) examining the abundance and distribution of dolphins over 230km² in southern Tampa Bay and the adjacent Gulf of Mexico; (2) identifying individual animals using photographs of scars and other natural markings on the dorsal fin; and (3) characterizing the range of movement and interactions among recognizable dolphins.

A total of 70 surveys were carried out using a 5m or 12m vessel. School size and number of calves was evaluated, behavior recorded and individuals photographed. Photographs were classified based on location of fin notches and cataloged.

Mean monthly dolphin school size was lowest in April (2.8) and highest in September (6.1). The largest schools were observed around the mouth of Tampa Bay where it joins the Gulf of Mexico. Zones with highest density were also around the Bay mouth. Mean density (dolphins/km²) was highest from July (0.38) through September (0.36). Calves constituted 9.7% of all dolphins observed.

Dolphins with distinct, naturally marked fins were recognizable in 142 of 319 schools; 246 animals were cataloged with 75 being sighted two to seven times. Thirty seven dolphins photographed three or more times were classified into three herds based on location of the sightings: a Tampa Bay herd, a Pinellas herd, and a Sarasota Bay herd. Members of the Tampa Bay herd were observed on both sides of the Bay and interacted with members of the Sarasota Bay and Pinellas herds.

The large number of recognizable animals sighted only once (171) suggests that transient dolphins, perhaps nearshore or offshore animals, use lower Tampa Bay for foraging in the summer months, probably following schools of mullet inshore. An apparently open population of dolphins used the study area, creating a high potential for genetic mixing. Dolphin ranges within the study area were calculated to be up to 166km² and may represent only a portion of the total home range of the animals studied.

INTRODUCTION

Research on bottlenose dolphins (*Tursiops truncatus*) in Florida has concentrated on populations that utilize shallow bays behind barrier islands (Odell and Asper, 1982; Irvine, Scott, Wells and Kaufman, 1981; Wells, 1978; Wells, 1986; Shane, 1987). With the exception of data from manatee aerial surveys on the west coast of Florida which included dolphin observations (Irvine, Caffin and Kochman, 1982) and photo-identification work in southern Tampa Bay as part of studies in adjacent Sarasota Bay (Scott, Wells and Irvine, 1990), little is known of the bottlenose dolphins that utilize Tampa Bay (Fig. 1).

The present study was undertaken in 1983–84 to examine the abundance and distribution of bottlenose dolphins in southern Tampa Bay and the adjacent Gulf of Mexico, to identify individual animals using photographs of scars and other natural markings on the dorsal fin and to characterize the range of movement and interactions among recognizable dolphins.

STUDY AREA

The study area, southern Tampa Bay, contained approximately 230km² of water surface area including Terra Ceia Bay, part of the Manatee River, lower Boca Ciega Bay and the Gulf of Mexico (Fig. 1). The northeastern boundary in Tampa Bay was delimited by a line which connected the St. Petersburg city pier and Port

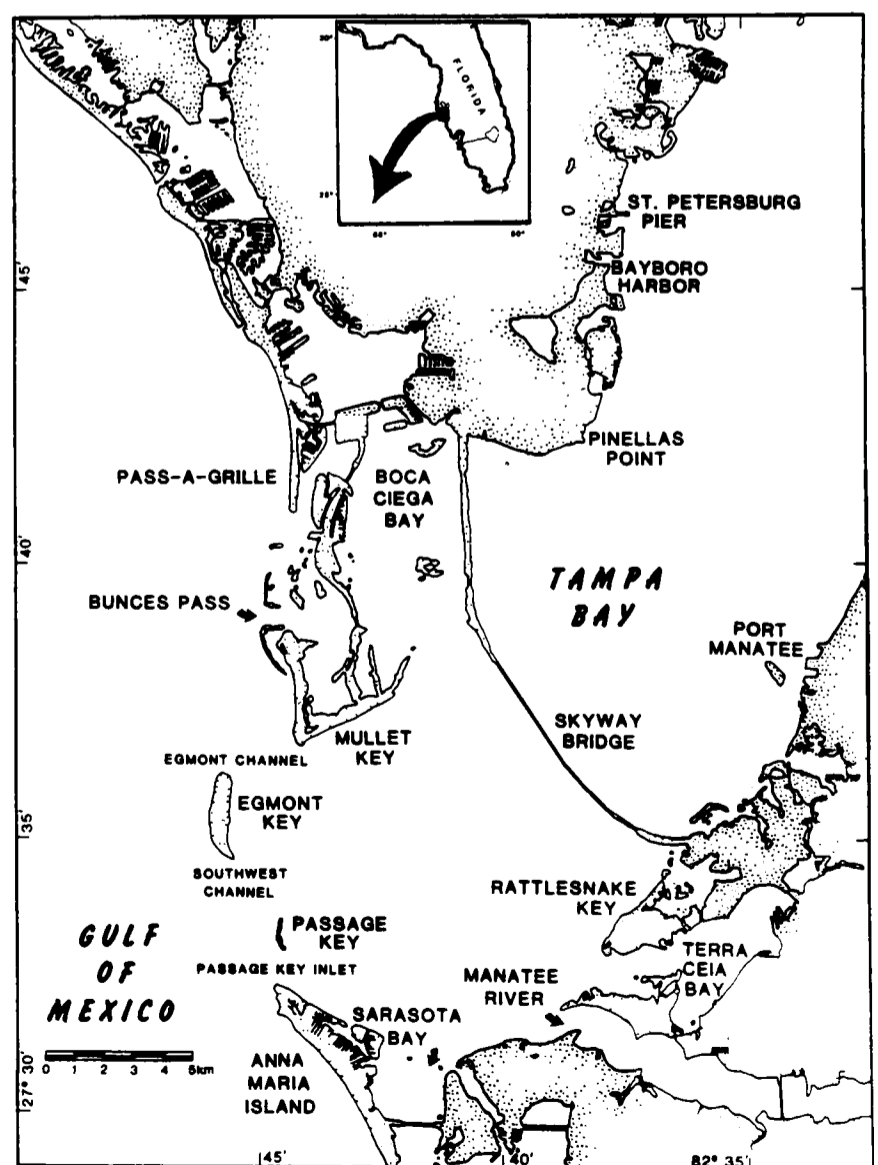

Fig. 1. Map of lower Tampa Bay, Florida.

* Present Address: Florida Department of Natural Resources, Marine Research Institute, 100 8th Avenue SE, St. Petersburg, Florida 33701.

Manatee. The western boundary in the Gulf of Mexico was roughly described by an arc which connected the northern tip of Anna Maria Island and Pass-a-Grille beach. The study area was divided into 18 zones based on bottom characteristics and features recognizable from the water e.g. deep channels, passes between land masses and bridges (Fig. 2).

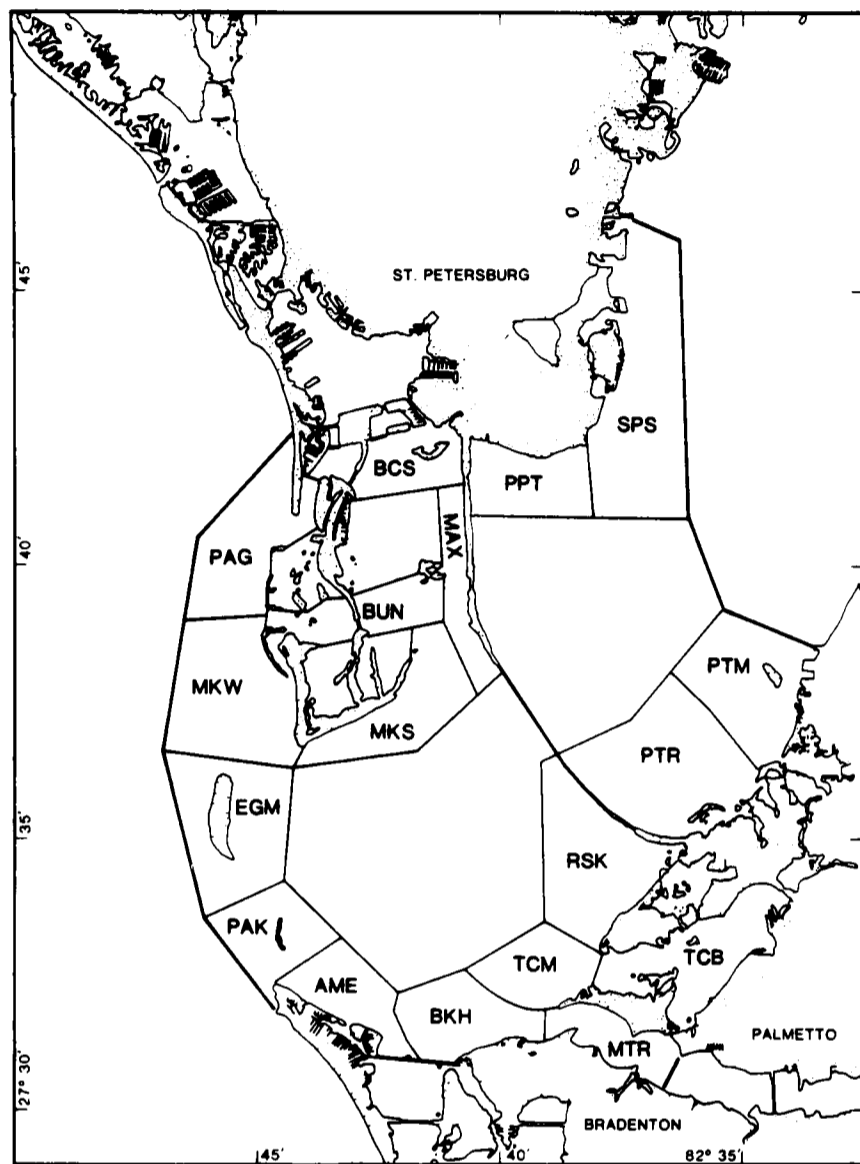

Fig. 2. Zones regularly surveyed in the study area.

Over 80% of the seagrasses in Tampa Bay have disappeared in the last 100 years (Lewis, Durako, Moffler and Phillips, 1985) due primarily to human development. However, extensive grass beds which serve as habitat for many of the fish species consumed by dolphins still occur in lower Tampa Bay. In much of the study area, the nearshore regions were characterized by shallow sand flats with seagrass beds composed of *Thalassia testudinum*, *Halodule wrightii*, and *Syringodium filiforme* (Lewis *et al.*, 1985). Egmont Channel, Southwest Channel, and Passage Key Inlet join Tampa Bay to the Gulf of Mexico (Fig. 1). These channels, cut by tidal action, separate areas of gently sloping sandy bottom. Salinity in the lower bay averages 30.1 parts per thousand and average water temperatures range between 16°C in the winter and 30°C in summer (Simon, 1974).

METHODS AND MATERIALS

Seventy boat surveys of bottlenose dolphins were conducted in the study area from April through October in 1983 (46 surveys) and 1984 (24). Two to ten surveys were conducted per month. During 1983, nearshore areas were surveyed using a 5.2m, center console boat powered by a

115HP outboard engine at a speed of 24–32km/h. Survey routes on the north and south sides of the bay were surveyed equally, usually on successive days. Direction of travel on the survey routes was randomized. Deep water areas of the lower bay were surveyed from the 12m R/V *Bonnie E*, operated by the Florida Department of Natural Resources (FDNR), as an adjunct to an ongoing blue crab tagging project being conducted through the Bureau of Marine Research in St. Petersburg. The R/V *Bonnie E* reached a top speed of 18km/h for surveys conducted while traveling between crabbing stations at the mouth of Bayboro Harbor, Port Manatee, Terra Ceia Bay, and Mullet Key. All observations in 1984 were made from the 5.2m boat due to completion of the FDNR blue crab tagging project. The nearshore survey routes were modified to include most of the area previously surveyed from the R/V *Bonnie E*. However, deeper areas in the middle of the Bay were not regularly surveyed in 1984.

When a school of dolphins was located, adults and calves were counted and location, time of day, direction of movement and behavior noted. A 'school' was defined as a group of dolphins in close association, usually participating in the same activity. 'Calves' were defined as small animals closely accompanying a larger dolphin and less than half the total length of the larger dolphin. The boat was maneuvered to approach the school slowly and match the direction of movement and speed on a parallel course. Photographs were taken of all school members, when possible, using 200ASA slide film in a 35mm camera equipped with a 70–210mm zoom lens and a motorized film winder. A polarizing filter was used on the lens to reduce reflections from the water surface. It was assumed that all dolphins present in a zone were seen and counted.

Slides were labeled by date and sighting number before sorting into groups of similar shaped fins while using a hand held 8x loupe eyepiece or a binocular microscope with up to 25x magnification. Only photographs showing a fin nearly perpendicular to the observer and having distinct dorsal fin patterns were assigned unique identification numbers based on the location of fin notches. Slides showing recognizable individuals were recorded in a catalog and filed by identification number. A tracing of each recognizable fin outline was made by projecting the slide onto a sheet of white paper. Using a zoom lens on the projector, the fin size was adjusted until the fin base measured 10cm. The fin outline was then traced onto the paper. Each photograph of a distinct fin pattern was matched to all others in the catalog having similar locations of notches. When a visual match was located in the catalog, the new fin photograph was projected onto the tracing of the potential match to confirm that the fin notches were in exactly the same location and that the fin shape was identical. Photographs meeting these criteria were then added to the catalog as resightings.

Photographs were also analyzed to confirm the number of dolphins in each school photographed. Slides for each school were sorted and compared based on fin shape using the tracing and zoom matching methods described above. For each survey date, comparisons between all schools in a zone and adjoining zones were also made to ensure that individual dolphins were not counted twice on the same date. The percentage of recognizable dolphins on any survey was calculated by dividing the number of recognizable dolphins by the total number of adult and juvenile dolphins counted in schools that were photographed.

Data collected during a survey were entered into a computer database. Sighting locations were plotted on maps of the study area. Dolphin density (dolphins/km²) was calculated for each survey by dividing the total number of dolphins sighted by the total area of the zones surveyed. Density for each survey zone was also calculated.

Dolphins which were sighted three or more times were classified as belonging to one of three 'herds' based upon sighting locations. Dolphins seen only along the south side of Tampa Bay, either in the water adjoining Sarasota Bay, in the Manatee River or in Terra Ceia Bay, were considered to be members of the Sarasota Bay herd previously identified by Irvine *et al.* (1981). Dolphins photographed only along the northern mouth of Tampa Bay, in the Gulf of Mexico or Boca Ciega Bay, were classified as members of the Pinellas County herd. The remaining resighted dolphins were identified on both sides of the Bay or in waters more than 15km away from the Bay mouth. These dolphins were identified as Tampa Bay animals.

An estimate of range within the study area was calculated for each dolphin assigned to a herd. Each range estimate was determined by summing the areas of zones where the dolphin was sighted with the areas of adjoining zones that included the dolphin's requisite travel path. For example, if a dolphin was sighted in zones BKH and RSK (Fig. 2), the area of zone TCM was added to the estimated range since the dolphin would have to travel through zone TCM or farther to have been seen in both locations.

Two nonparametric statistical analyses were used for comparisons of school size, total density and zone density among months and years. The Kruskal-Wallis test compared multiple groups and the Mann-Whitney U test compared two sample groups. Both tests are considered analogues of a single classification analysis of variance when the assumptions of random sampling cannot be met (Sokal and Rohlf, 1969).

RESULTS

Schools of dolphins were sighted 319 times during the surveys with a total of 1,606 animals counted. Schools contained between one and 40 dolphins with a mean of 5.0 for all sightings. Groups of two dolphins were most commonly sighted and 91% of all schools had ten or fewer animals. Single animals constituted 12% of all sightings. Six sightings were of schools containing more than 20 dolphins; all six were observed in the Gulf of Mexico during July, September and October.

Mean school size showed significant variation among months (Kruskal-Wallis, $p < 0.05$). Mean school size was smallest in April (2.85) and largest in September (6.1) (Fig. 3). No significant difference was observed when comparing school size by month for successive years (Mann-Whitney, $p = 0.05$).

School size showed significant variation among the 18 regularly surveyed zones (Kruskal-Wallis, $p < 0.05$). Mean school sizes were highest in the areas around Mullet Key at the northern mouth of Tampa Bay (zones MKW and MKS), around Passage Key at the southern mouth (PAK) and in Terra Ceia Bay (TCB). All of the remaining zones had significantly lower school sizes (Mann-Whitney, $p < 0.05$).

Calves constituted 9.7% of all dolphins observed. Monthly calf sightings varied from 0.0% in April of both years to 12.2% in August. Twenty-nine percent of all

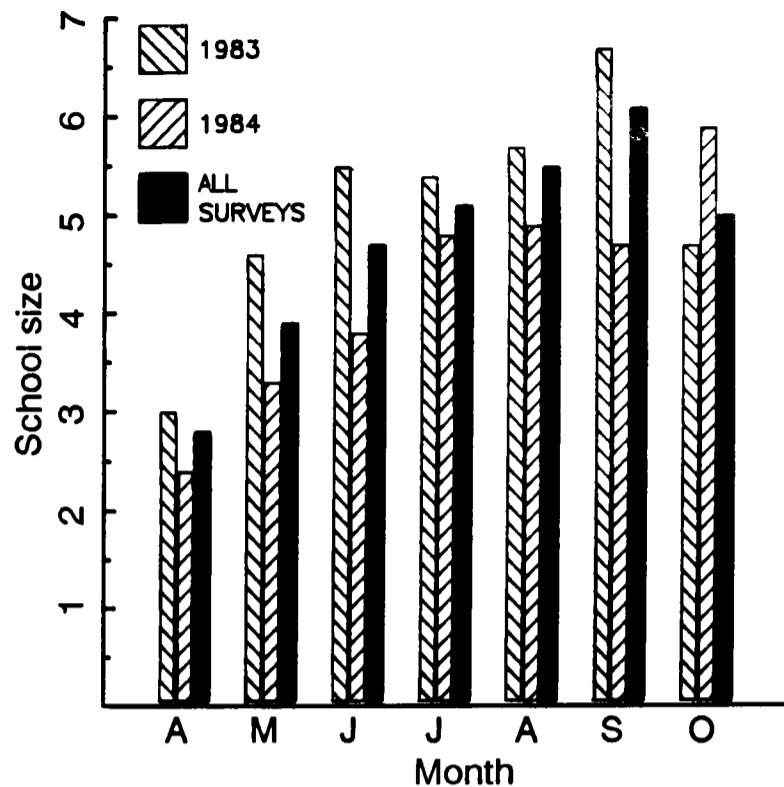

Fig. 3. Mean dolphin school size in lower Tampa Bay.

schools contained one or more calves. In August, 42% of all schools contained at least one calf. The number of calves per school was highest in the same areas where mean school size was highest: zones MKW, MKS, PAK and TCB.

Dolphin density (dolphins/km²) was calculated for each survey and for each zone surveyed. Mean density for lower Tampa Bay over all surveys was 0.27 dolphins/km². Densities showed significant variation among months (Kruskal-Wallis, $p < 0.05$). Mean density values were lowest in April, increased during May and June, and peaked at significantly higher levels during July, August and September (Fig. 4). A decline in density was observed during October of 1983, but in 1984 density remained at levels observed during the summer months.

Zones showing the highest mean densities were around the mouth of Tampa Bay. The zone along the south shore of Mullet Key (MKS) averaged almost ten animals for each survey of the area with an average density of 0.78

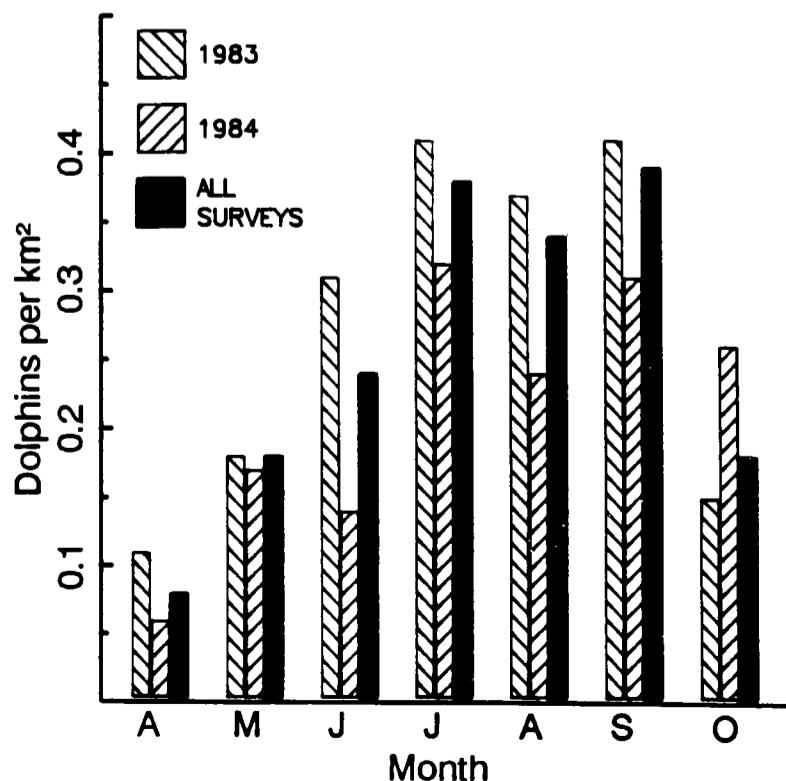

Fig. 4. Mean monthly dolphin density in lower Tampa Bay.

dolphins/km². Other areas showing high densities were around Passage Key (PAK), along the east shore of Anna Maria Island (AME) and in Bunces Pass (BUN).

Photographs were taken of 70% of all schools located. Photographed schools had a mean size of 6.0 dolphins of which 10.6% were calves. The remaining 30% of the schools avoided the survey boats for photographs and had a mean size of 2.7 dolphins with 5.0% calves.

Dolphins with distinct naturally-marked dorsal fins were recognizable in 142 (64%) of the 223 schools which were photographed. Of the 1,205 adult or juvenile dolphins photographed, 399 animals (33%) had fins that could be classified as recognizable. Analysis of the photographs resulted in assignment of unique identification numbers to 246 dolphins. Seventy five of the recognizable animals were resighted.

Thirty seven dolphins identified on three or more occasions were classified into herds based on location of the sightings. Thirteen dolphins were assigned to the Sarasota Bay herd, 14 to the Pinellas herd, and 10 to the Tampa Bay herd. Locations of schools containing dolphins assigned to one of the three herds were plotted in Fig. 5 (see Weigle (1987) for representative photographs of recognizable animals from lower Tampa Bay). The remaining 209 recognizable dolphins sighted on one or two surveys were not assigned to herds.

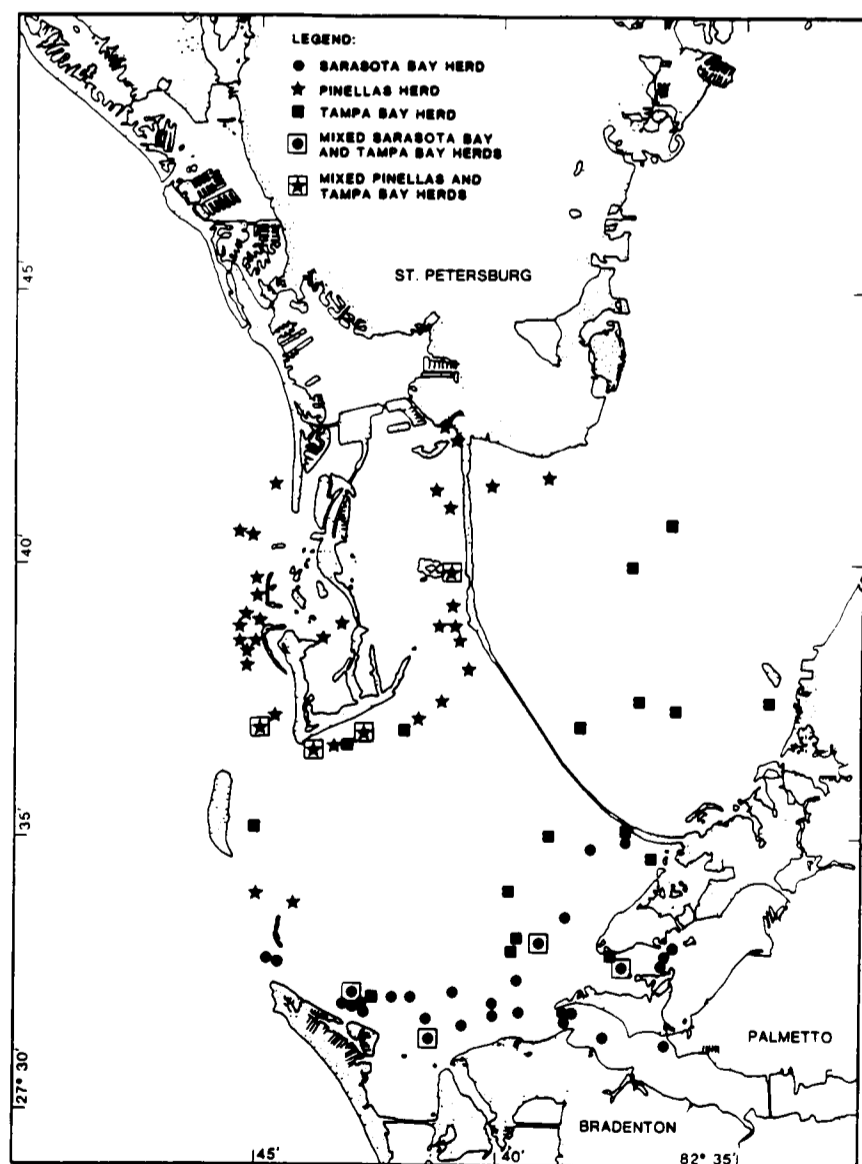

Fig. 5. Locations where dolphins assigned to herds were identified.

Photographs were taken of an additional 82 schools where no dolphins were cataloged. The sightings averaged 3.7 dolphins per school and were primarily located away from the mouth of Tampa Bay. Ninety six schools were not photographed and averaged 2.7 dolphins per school.

Recognizable dolphins accounted for 33% of all dolphins photographed (Fig. 6). A substantial increase in this percentage occurred during the 1984 sampling period due primarily to the exclusive use of the 5.2m research platform during 1984: the percentage of recognizable animals increased to 49% in 1984 from 25% in 1983. A breakdown of the data revealed that the recognizable percentage from the DNR crab project vessel averaged only 11% compared to 39% of the animals photographed from the 5.2m boat. Much of this difference can be accounted for by the amount of time which was spent photographing schools. Since the dolphin survey was an adjunct activity to the DNR crab project, only a limited amount of time was available to spend taking photographs of dolphins encountered. It was often not possible to spend the amount of time required to obtain adequate photographs of every school member. From the 5.2m boat, there were no time restrictions and the number of recognizable photographs rose appreciably. The additional factors of increased experience and acclimation of the dolphins to the 5.2m survey boat may have also contributed to higher percentage of recognizable animals in 1984: 39% compared to 32% in 1983. The percentage of new identifications remained above the 50% level for all but two of the survey months. New identifications continued to occur through the last survey.

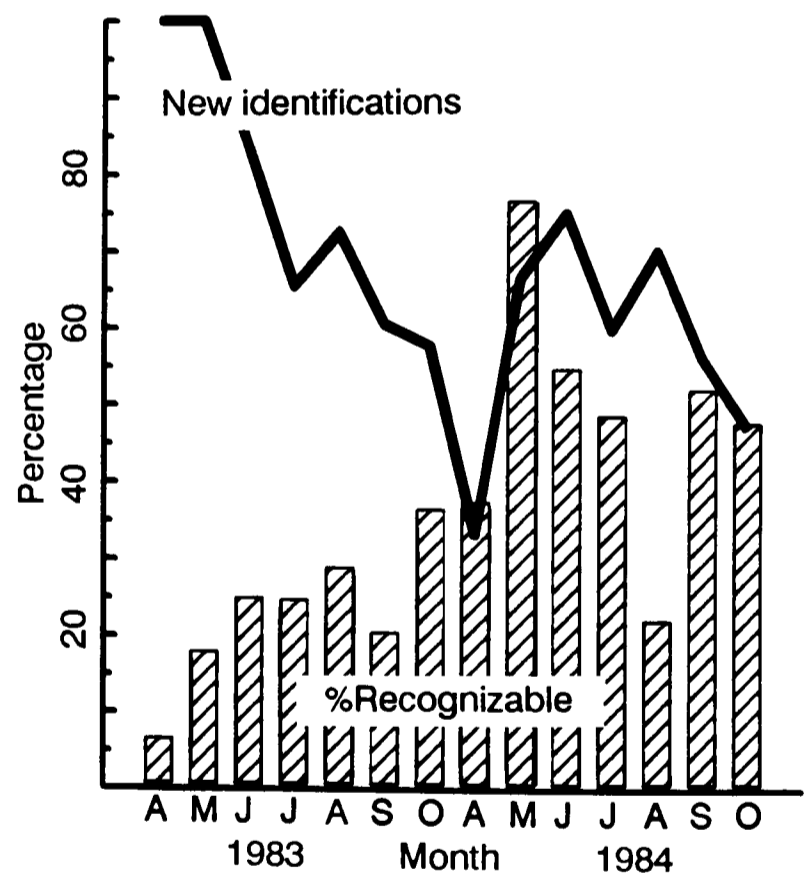

Fig. 6. Recognizable dolphins as a percentage of all adult dolphins photographed and new identifications as a percentage of all dolphins identified.

Sarasota Bay dolphins were identified in 30 different schools located between Passage Key and the south end of the Sunshine Skyway Bridge. A majority of the sightings were made in survey zones AME and BKH adjacent to the mouth of Sarasota Bay. Three of the Sarasota Bay dolphins were identified as females (numbers 119, 192 and 123) because calves closely accompanied them. Two of the females (123 and 192) had ranges which extended into the Manatee River and Terra Ceia Bay. Three other dolphins (numbers 105, 166, 525) were identified up to 10km away from Sarasota Bay near the Skyway Bridge.

Tampa Bay dolphins were photographed in 25 schools on both sides of the Bay. On four occasions, Tampa Bay animals were found in schools containing one or more Sarasota Bay animals. Dolphins from the Sarasota Bay and Pinellas herds were never identified in the same school. Of the 25 sightings of schools containing Tampa Bay animals, only two schools were sighted during 1983 in the deeper waters of Tampa Bay which were not surveyed during 1984. Low rates of school sightings in the deeper waters and the termination of the DNR crab project resulted in the discontinuance of the surveys across the Bay between Mullet Key and Rattlesnake Key and between Port Manatee and Pinellas Point. Because of this change, potential sightings and resightings of Tampa Bay herd members may have been missed. However, the elimination of the two transects was considered of minimal importance due to the low sighting rates experienced in the middle of the Bay during 1983.

Pinellas dolphins were identified in 35 schools in the Gulf from Pass-a-Grille to Passage Key and east along the northern Bay mouth to Pinellas Point. Most of the Pinellas schools were found west of the Skyway Bridge in the dredged channel leading from Boca Ciega Bay to Tampa Bay and along the coastline of Mullet Key. Identifiable dolphins from this herd were often seen entering and leaving the study area to the north along the Gulf shoreline.

Tampa Bay and Pinellas dolphins were identified in the same schools four times. Three of the mixed schools were located near the southwestern tip of Mullet Key where Tampa Bay joins the Gulf. The schools contained 31, 10 and 40 dolphins when sighted in July 1983, September 1984 and October 1984, respectively. The fourth mixed school consisted of five dolphins feeding together; two were identified as Pinellas animals and one was a Tampa Bay animal. Two hours later, the Tampa Bay dolphin (number 527) was identified in the mixed herd of 40 animals described above at a location 8km away from the first sighting.

After resighted dolphins had been categorized into herds based on location, the slides were compared to the catalog of known dolphins accumulated by Dolphin Biology Research Associates (DBRA) which numbered about 200 individual animals in 1984 (Wells, 1986). Nine of the 13 dolphins classified as members of the Sarasota Bay herd were in the catalog while only one Pinellas dolphin was found (number 007). During this research, number 007 was sighted north of Passage Key, along the west shore of Mullet Key and in Bunces Pass. Previously it was sighted between Sarasota Bay and the mouth of the Manatee River in 1980 and west of Egmont Key in 1982 (R. Wells, pers. comm.). Three of the dolphins categorized into the Tampa Bay herd were identified in the DBRA catalog, with one animal (number 207 called 'Moonfin' by DBRA) having been seen over the last 10 years. This animal had the largest range in lower Tampa Bay, estimated at 166km². It was spotted at the extreme edges of the study area: in the channel off south St. Petersburg, at the mouth of Terra Ceia Bay and in the Gulf of Mexico at Mullet Key.

DISCUSSION

Calculated values for mean dolphin density in lower Tampa Bay were found to be within the range of previously reported densities on the west coast of Florida (see Leatherwood and Reeves, 1982; Shane, Wells and Würsig, 1986). The mean low values found in April (0.06

dolphins/km²) were similar to Gulf of Mexico offshore densities determined by aerial surveys (Odell and Reynolds, 1980). The highest monthly values obtained during summer surveys (0.38) approximated density figures from aerial surveys in the northern coast of the Gulf of Mexico (Leatherwood, Gilbert and Chapman, 1978) and in Charlotte Harbor to the south (Thompson, 1981). Direct comparisons between density estimates from boating surveys and aerial surveys should be made cautiously. A comparison of simultaneous surveys for harbor porpoise, *Phocoena phocoena*, using these methodologies showed that shipboard surveys were superior in estimating distribution and abundance but aircraft were effective in areas with high animal densities (Kraus, Gilbert and Prescott, 1983). No similar study has been published for bottlenose dolphins.

Significantly higher densities of dolphins from July through September strongly suggest a summer influx into lower Tampa Bay by members of the three identified herds and by a large number of transient dolphins identified only once or twice. Since the study area contained the apparent southern end of the home range for Pinellas dolphins and the northern end of the range for Sarasota Bay dolphins, many of the 209 identifiable transients are likely to be members of these herds or the Tampa Bay herd.

An offshore form of bottlenose dolphin has been identified which is larger than the inshore form, has differences in skull measurements and a distinctive hemoglobin and red blood cell profile (Mitchell, 1975; Leatherwood and Reeves, 1982; Hersh, 1987). It is thought that this offshore form sometimes moves inshore to forage on mullet. Striped mullet, *Mugil cephalus*, is considered by some researchers to be the primary food item of dolphins in the Gulf of Mexico (Gunter, 1942; Caldwell and Caldwell, 1972). However, a recent study of 44 stranded bottlenose dolphins from the southeastern USA, found that mullet was not among the four most important prey species (Barros, 1987). Mullet occurred in 25% of all animals examined and 36% of the dolphin carcasses recovered in southwest Florida. Mullet migrate up to 50km offshore from Tampa Bay during colder months (B. Mahmudi, FDNR, pers. comm.) and return to the bay when the water temperature warms. It is possible that offshore dolphins follow the mullet schools inshore and account for a portion of the observed summer increase in density, particularly around the mouth of Tampa Bay and some of the transients seen in this study may represent offshore form animals. However it is more likely that dolphins which live in the nearshore Gulf of Mexico or inshore behind the barrier islands north and south of the study area are the source for much of the observed increase. Records from the southeastern USA cetacean stranding network currently contain no evidence of the offshore ecotype being recovered in the Tampa Bay area (Odell, pers. comm.).

A trend toward larger school size in deeper water and in other open habitats has been observed (Shane *et al.*, 1986) and is presumably a mechanism for cooperative foraging and protection. The six largest groups encountered during this study were located in the Gulf of Mexico around the mouth of Tampa Bay. All six groups contained 20 or more dolphins, the majority of which were not identifiable herd members even though many had distinct dorsal fins. An additional group of 18 dolphins was observed crossing the deepest part of the bay from Mullet Key to Rattlesnake Keys in June 1983. Only one of the animals (number 501) was identifiable from photographs. It had been sighted

over two months earlier off Rattlesnake Key and was not sighted again during the study. This animal was identified in the DBRA catalog as 'Small Leadslice' and had been observed near New Pass in the Gulf of Mexico at Sarasota, 28km south of Tampa Bay (Wells, pers. comm.).

Two patterns of movement were observed that support the theory that transient dolphins enter Tampa Bay to feed during the summer. Dolphins from the Sarasota herd that used the bay as far north as the Skyway Bridge were usually seen travelling between the shoreline and the 2m depth contour where seagrass beds terminated. Groups that contained recognizable individuals not assigned to any herd were observed entering and leaving Tampa Bay primarily through Passage Key inlet. The groups without identifiable herd members did not turn and follow the 2m contour. Instead, they headed directly to the northeast towards the Skyway Bridge in water 4m to 5m deep. Additional unassigned groups were encountered in the deeper waters of survey zones PTR and PTM to the northeast of the Skyway Bridge as they headed toward Port Manatee and upper Tampa Bay.

Coastal surveys of bottlenose dolphins in Florida have found mean group sizes ranging from three to 12 animals (Caldwell and Caldwell, 1972; Odell, 1976; Leatherwood, 1979; Odell and Reynolds, 1980; Wells *et al.*, 1980; Irvine *et al.*, 1981; Shane, 1987). The mean school size of 5.0 dolphins found during the present study is consistent with other coastal surveys on the west coast of Florida (Odell and Reynolds, 1980; Wells *et al.*, 1980) but lower than the eight dolphins per school found on the east coast in the Indian River (Leatherwood, 1979) and Biscayne Bay (Odell, 1976).

Previous research has provided support for the hypothesis that calving peaks occur in the spring and fall (see Leatherwood and Reeves, 1982). The percentage of calves observed during this study (9.7%) was in agreement with results from other recent research in Florida but the peaks in calf observations in Tampa Bay do not match the hypothesized spring and fall calving peaks. It is likely that lower Tampa Bay is not a major spring calving ground, but that female-calf pairs and associated schools move into Tampa Bay during the summer months.

The Tampa Bay herd of associated dolphins could represent nearshore animals which travel throughout lower Tampa Bay, unconstrained by the apparent range boundaries of the Sarasota Bay and Pinellas herds. Of the nine dolphins assigned to the Tampa Bay herd, a year elapsed between sightings of six of the animals. One other animal was seen only during the first year of surveys, 1983. The remaining two dolphins were observed together on three occasions beginning on 19 May 1984. They were reidentified on 17 June near Port Manatee and subsequently were identifiable as males on 21 July after being tagged by DBRA (R. Wells, pers. comm.). The sex of the other herd members was not determined. The wide ranging tendencies of this herd were reflected in the large estimated ranges within the study area. The mean range (84.5km²) was over twice as large as that estimated for the Pinellas herd (40.4km²) and almost three times greater than the Sarasota Bay herd range (28.7km²). These ranges reflect only the area utilized in the 230km² study area and lower Tampa Bay represents only a portion of the total range of dolphins found there.

The large number of transient dolphins in lower Tampa Bay is underscored by the high percentage of recognizable dolphins that were newly identified even during the last

months of surveys (Fig. 6). In an area where immigration and emigration were negligible, one would expect new identifications to decrease following an initial survey period. Some new identifications would be expected due to new scars on young animals and drastic changes which render old identifications useless. However, even at the end of this study, new identifications accounted for about 50% of all recognizable dolphins. This indicated a substantial amount of transient dolphin movement into and out of lower Tampa Bay and strongly supports the theory that lower Tampa Bay has an open population of *Tursiops* where immigration and emigration are common.

In an area with an open population where ranges of adjacent herds overlap, the possibility exists for genetic mixing. Analysis of blood samples of dolphins in the Indian River on the east coast of Florida identified social units with differing electrophoretic profiles (Duffield, Asper, Odell and Provanca, 1985a) and mixing between the social units was detected. In the Tampa Bay area, the presence of an extra chromosome in certain Sarasota Bay females and their offspring could assist in the determination of the degree of genetic mixing in the area (Duffield, Chamberlin-Lea, Wells and Scott, 1985b). Sampling would have to include representatives of each of the identified herds as well as the numerous area transients. The development of a technique to obtain biopsy samples from free-ranging large and small cetaceans (e.g. Lambertsen, 1987) will make sophisticated population studies a reality without the expense of a capture operation. A genetic and photographic catalog of bottlenose dolphins which could encompass an area the size of the west coast of Florida would provide the data to address many of the questions concerning population movements and interactions.

In summary, the following conclusions were reached about the dolphins which utilize lower Tampa Bay:

- (1) dolphin school size (mean 5.0, SD=4.9, N=319) and calf percentage (9.7%) are comparable to results from other areas in Florida and the Gulf of Mexico;
- (2) density was variable with highest values during the summer months (July=0.38/km²; August=0.34; September=0.39);
- (3) density was not evenly distributed over the study area but was highest in zones around the mouth of Tampa Bay;
- (4) at least three herds of dolphins utilize the area with distinct areas of overlap where mixing of herd members was observed;
- (5) a large number of transient dolphins also utilize the area seasonally;
- (6) an open population of dolphins uses the lower Tampa Bay, creating a high potential for genetic mixing.

ACKNOWLEDGEMENTS

This research was performed as part of a MS degree program at the University of South Florida Marine Science Department. Joseph Torres and John Reynolds offered sound guidance in all phases of the project. I am thankful for the financial and emotional assistance provided by my wife, Linda Dias, and my parents, Mary and Lyman Weigle. Logistical support was also provided by the Florida Department of Natural Resources Marine Research Institute. Field assistance provided by Karen Brown, Jack Gartner, Joe Donnelly and other USF students was

essential to the completion of the work. I also want to thank Dr Reynolds, Daniel Odell, Michael Scott, Randy Wells, Greg Donovan, Phil Hammond and an anonymous reviewer for substantial comments which helped to improve the manuscript.

REFERENCES

- Barros, N.B. 1987. Food habits of bottlenose dolphins (*Tursiops truncatus*) in the southeastern United States, with special reference to Florida waters. MSc thesis, University of Miami, Coral Gables, Florida. 140pp.
- Caldwell, M.C. and Caldwell, D.K. 1972. Behavior of marine mammals. pp.419-65. In: S. H. Ridgway (ed.) *Mammals of the Sea: Biology and Medicine*. C.C. Thomas, Springfield, IL.
- Duffield, D.A., Asper, E.D., Odell, D.K. and Provancha, J. 1985a. Movements and association patterns of wild bottlenose dolphins of different genotype in the Indian River system. Presented to the Sixth Conference on the Biology of Marine Mammals, Vancouver, Canada, November 1985 (unpublished).
- Duffield, D.A., Chamberlin-Lea, J., Wells, R.S. and Scott, M.D. 1985b. Inheritance of an extra chromosome in a resident female band of bottlenose dolphins in Sarasota, Florida. Presented to the Sixth Conference on the Biology of Marine Mammals, Vancouver, Canada, November 1985 (unpublished).
- Gunter, G. 1942. Contributions to the natural history of the bottlenose dolphin, *Tursiops truncatus*, on the Texas coast, with particular reference to food habits. *J. Mammal.* 23:267-76.
- Hersh, S.L. and Duffield, D.A. 1990. Distinction between northwest Atlantic offshore and coastal bottlenose dolphins based on hemoglobin profile and morphometry. pp. 129-139. In: S. Leatherwood and R.R. Reeves (eds.) *The Bottlenose Dolphin*. Academic Press, San Diego. 653pp.
- Irvine, A.B., Caffin, J.E. and Kochman, H.I. 1982. Aerial surveys for manatees and dolphins in western peninsula Florida. *Fish. Bull.*, US 80:621-30.
- Irvine, A.B., Scott, M.D., Wells, R.S. and Kaufman, J.H. 1981. Movements and activities of the Atlantic bottlenose dolphin, *Tursiops truncatus*, near Sarasota, Florida. *Fish. Bull.*, US 79:671-88.
- Kraus, S.D., Gilbert, J.R. and Prescott, J.H. 1983. A comparison of aerial, shipboard, and land-based survey methodology for the harbor porpoise, *Phocoena phocoena*. *Fish. Bull.*, US 81:910-13.
- Lambertsen, R.H. 1987. A biopsy system for large whales and its use for cytogenetics. *J. Mammal.* 68:443-5.
- Leatherwood, S. 1979. Aerial survey of the bottlenose dolphin, *Tursiops truncatus*, and the West Indian Manatee, *Trichechus manatus*, in the Indian and Banana Rivers, Florida. *Fish. Bull.*, US 77:47-59.
- Leatherwood, J.S., Gilbert, J.W. and Chapman, D.G. 1978. An evaluation of some techniques for aerial censuses of bottlenosed dolphins. *J. Wild. Manage.* 42:239-50.
- Leatherwood, S. and Reeves, R.R. 1982. Bottlenose dolphin (*Tursiops truncatus*) and other toothed cetaceans. pp.369-414. In: J.A. Chapman and G.A. Feldhamer (eds.) *Wild Mammals of North America*. John Hopkins University Press, Baltimore, MD.
- Lewis, R.R., Durako, M.J., Moffler, M.D. and Phillips, R.C. 1985. Seagrass meadows of Tampa Bay - a review. pp.210-246. In: J.F. Treat, J.L. Simon, R.R. Lewis and R.L. Whitman (eds.) *Proceedings of Tampa Bay Area Scientific Information Symposium*. Report Number 65. Florida Sea Grant College. Grant No. NA80AA-D-00038. Tampa BASIS, P.O. Box 15759, Tampa, FL 33684.
- Mitchell, E.D. (ed.) 1975. Report of the meeting on smaller cetaceans, Montreal, 1-11 April 1974. *J. Fish. Res. Bd Can.* 32:923-5.
- Odell, D.K. 1976. Distribution and abundance of marine mammals in south Florida: Preliminary results. *Univ. Miami Sea Grant Special Rep.* 5:203-12.
- Odell, D.K. and Asper, E.D. 1982. Live capture, marking, and resighting of bottlenose dolphins, *Tursiops truncatus*. Final report to National Marine Fisheries Service. Contract No. NA80-GA-C-00063. 325pp. Rosenstiel School of Marine and Atmospheric Science, University of Miami, 4600 Rickenbacker Causeway, Miami, FL 33149.
- Odell, D.K. and Reynolds, J.E. III. 1980. Abundance of the bottlenose dolphin, *Tursiops truncatus*, on the west coast of Florida. National Technical Information Service PB-80-197650. 47pp. US Department of Commerce, Springfield, VA 22161.
- Scott, M.D., Wells, R.S. and Irvine, A.B. 1990. A long-term study of bottlenose dolphins on the west coast of Florida. pp. 235-244. In: S. Leatherwood and R.R. Reeves (eds.) *The Bottlenose Dolphin*. Academic Press, San Diego. 653pp.
- Shane, S.H. 1980. Occurrence, movements, and distribution of bottlenose dolphins, *Tursiops truncatus*, in southern Texas. *Fish. Bull.*, US 78:593-601.
- Shane, S.H. 1990. Behavior and ecology of the bottlenose dolphin at Sanibel Island, Florida. pp. 245-265. In: S. Leatherwood and R.R. Reeves (eds.) *The Bottlenose Dolphin*. Academic Press, San Diego. 653pp.
- Shane, S.H., Wells, R.S. and Würsig, B. 1986. Ecology, behavior and social organization of the bottlenose dolphin: a review. *Mar. Mamm. Sci.* 2:34-63.
- Simon, J.L. 1974. Tampa Bay estuarine system - a synopsis. *Florida Scientist* 37:217-44.
- Sokal, R.R. and Rohlf, F.J. 1969. *Biometry*. W.H. Freeman and Company, San Francisco, CA.
- Thompson, N.B. 1981. Estimating abundance of *Tursiops truncatus* in Charlotte Harbor, Florida. National Marine Fisheries Service-SEFL, Miami Laboratory, Fishery Anal. Div. Rept.
- Weigle, B.L. 1987. Abundance, distribution, and movements of bottlenose dolphins, *Tursiops truncatus*, in lower Tampa Bay, Florida. MSc thesis, University of South Florida, Tampa, Florida. 47pp.
- Wells, R.S. 1986. Population structure of bottlenose dolphins: Behavioral studies along the central west coast of Florida. Contract Rept. to National Marine Fisheries Service, Southeast Fisheries Center. Contract No. 45-WCNF-5-00366. 58pp.
- Wells, R.S., Hansen, L.J., Baldrige, A.B., Dohl, T.P., Kelly, K.L. and Defran, R.H. 1990. Northward extension of the range of bottlenose dolphins along the California coast. pp. 421-431. In: S. Leatherwood and R.R. Reeves (eds.) *The Bottlenose Dolphin*. Academic Press, San Diego. 653pp.
- Wells, R.S., Irvine, A.B. and Scott, M.D. 1980. The social ecology of inshore Odontocetes. pp.263-317. In: L.M. Herman (ed.) *Cetacean Behavior: Mechanisms and Function*. John Wiley & Sons, New York, NY.
- Wells, R.S. and Scott, M.D. 1990. Estimating bottlenose dolphin population parameters from individual identification and capture-release techniques. Paper SC/A88/P23 (published in this volume).
- Wells, R.S., Scott, M.D. and Irvine, A.B. 1987. The social structure of free-ranging bottlenose dolphins. pp. 247-305. In: H. Genoways (ed.) *Current Mammalogy Volume 1*. Plenum Press, New York. 519pp.

Population Characteristics of Right Whales (*Eubalaena glacialis*) Observed in Cape Cod and Massachusetts Bays, 1978–1986

Philip K. Hamilton and Charles A. Mayo

Center for Coastal Studies, PO Box 1036, Provincetown, Mass. 02657, USA

ABSTRACT

Right whale, *Eubalaena glacialis*, occurrence in Cape Cod and Massachusetts Bays was investigated from 1978 through 1986. Using photo-identification techniques, a total of 113 individual whales were identified with a maximum of 47 whales sighted during a calendar year. Although whales were sighted in all months of the year except December, peak abundance occurred from February through April. Mothers with calves consistently appeared in April or later. The mean calving interval of nine mature females was three years. Residency in the study area varied from one to 165 days. An unusual summer residency group, including nine mother/calf pairs, present in the study area from July through October 1986, is discussed.

INTRODUCTION

The northern right whale, *Eubalaena glacialis*, was formerly both abundant and widely distributed in the North Atlantic. Hunted as early as the 10th century (Aguilar, 1986), the population was commercially depleted by the mid-1700s (Allen, 1908). Today, the distribution of this species in the North Atlantic appears to be broadly confined to the east coast of North America (CeTAP, 1982), with the population estimated at between 200 and 400 animals (Kraus and Prescott, 1985).

Evidence from sighting surveys and from movements of identified individual whales suggests that this remnant population calves primarily off the coast of the southeastern United States (Mead, 1986; Winn, Price and Sorensen, 1986; Kraus, Prescott, Knowlton and Stone, 1986b). Winn *et al.* (1986) proposed that females with calves migrate northwards in coastal waters to reach the southern Gulf of Maine in early spring, when concentrations of right whales are typically observed there (Watkins and Schevill, 1982). Many whales then continue north to the northern Gulf of Maine in the summer and fall. However, the winter distribution remains unknown.

The role of Cape Cod Bay and Massachusetts Bay in the distribution of the right whale has been unclear. Historical data and recent sporadic surveys have suggested that the region may be host to significant numbers of whales during late winter and early spring (Allen, 1869; Reeves, Mead and Katona, 1978; CeTAP, 1982; Schevill, Watkins and Moore, 1986), but consistent data have been lacking. This paper reports the population characteristics of individually identified right whales observed in Cape Cod and Massachusetts Bays during the period 1978 to 1986, including the results of year-round surveys of the area beginning in 1984.

METHODS

The study area is shown in Fig. 1. Cape Cod Bay is a semi-enclosed sandy basin with depths as great as 60m. Massachusetts Bay lies north of Cape Cod; its major hydrographic feature is Stellwagen Bank, an elongate glacial feature of sand and gravel approximately 25km long. The bank is defined by the 40m isobath, and the minimum depth is 18m. Elsewhere in Massachusetts Bay

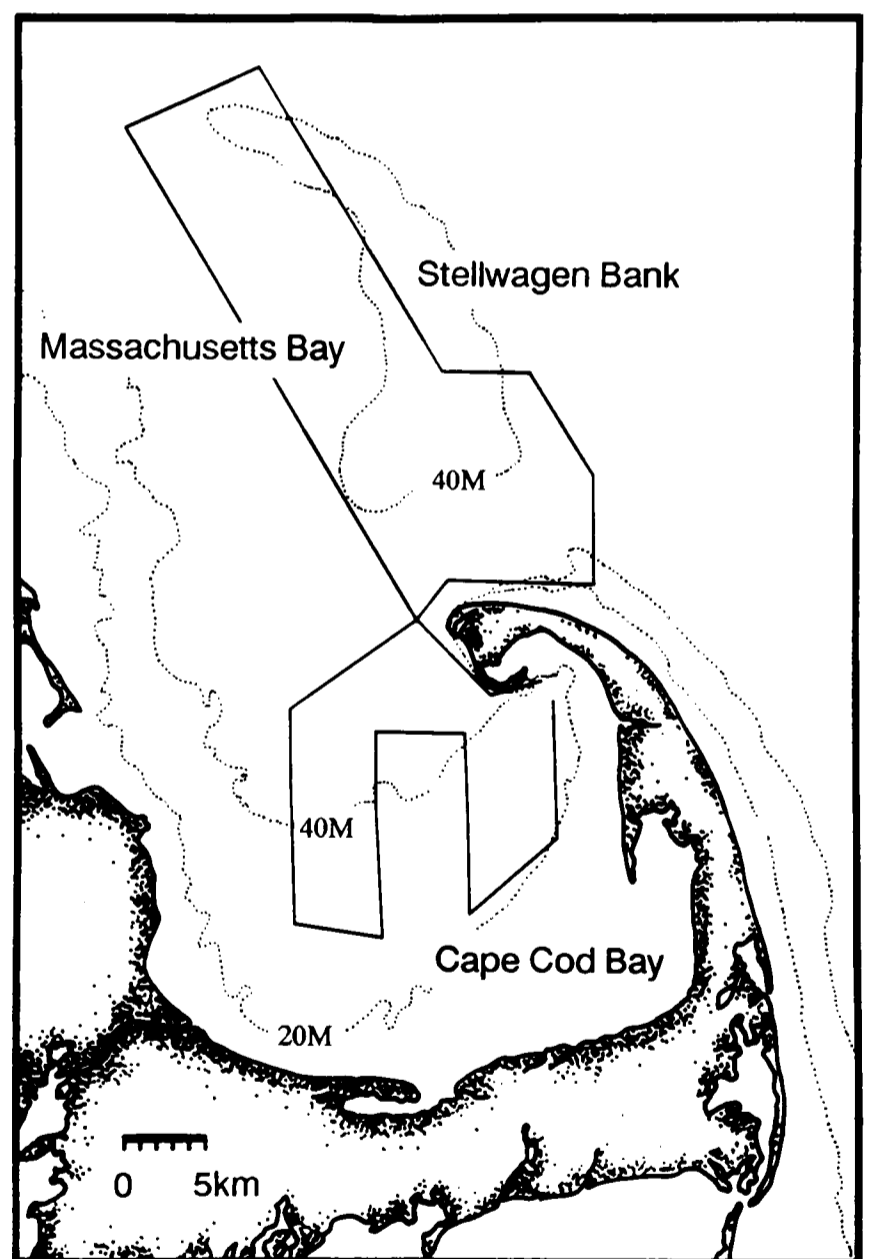

Fig. 1. Study area and survey tracks.

depths range from 40m to 100m. Sea surface temperatures in the study area range from -1°C in mid-winter to 23°C in August (G. Giese, unpublished data).

Observations were made from two types of vessels: (1) a variety of 30m commercial whalewatching boats conducting daily four-hour cruises out of Provincetown,

Massachusetts from April through October each year between 1978 and 1986 and (2) a 12m diesel-powered research vessel operating year-round beginning in January 1984. The tracks of the whalewatching vessels were determined by the captains, and were not random. The research vessel surveyed fixed tracks (Fig. 1) between January and May each year. Due to frequent unfavourable weather, the tracks were not surveyed equally; effort was concentrated in the eastern portion of Cape Cod Bay.

Standardization of effort is impossible due to the varied nature of the sampling. For example, in addition to their non-systematic searching strategy, the whalewatching vessels represented a sighting platform of twice the height of the research vessel and usually travelling at twice the speed. However, in order to obtain a coarse overview of seasonal changes in abundance, we have calculated monthly abundance indices by dividing the number of individual whales photographed in a month by the number of 'four-hour' cruises made (four hours being the duration of the majority of cruises undertaken during the study). Cruises lasting eight hours or more were divided into four-hour segments and treated as separate cruises.

Whales were photographed with 35mm SLR cameras equipped with 200–400mm lenses, power winders and recording databacks. *Kodak* Tri-X or T-Max black and white film (ISO 400) was used. Individual whales were identified using variations in callosity pattern, lip ridges and prominent scars (Payne, Brazier, Dorsey, Perkins, Rowntree and Titus, 1983; Kraus, Moore, Price, Crone, Watkins, Winn and Prescott, 1986a). Copies of photographs were sent to the North Atlantic Right Whale Consortium Catalogue at the New England Aquarium in Boston, where each whale was matched to a previously catalogued whale or assigned a new catalogue number.

The gender of an individual can be determined from photographs of the genital area or, in the case of females, can be assumed from observations of the whale with a calf. For example, a whale was considered to be female if it was observed within a body length of a calf, with no other whales present; or if it was sighted at least three times with a calf. Any whale that was seen repeatedly within a body length of another whale and was a third the size or less was considered to be a calf. A whale was considered sexually mature if it was known to be at least seven years of age (Payne, 1986) or was a known mother. A whale was

considered a juvenile if it was known to be less than five, but was not a calf. Whales known to be five or six years of age were treated separately due to the possibility of variability in the age of sexual maturity (Kraus, pers. comm.). Although the 1987 data have not been completely analysed, the mother and calf data have been included here to permit a more reliable assessment of calving intervals. In addition to information on these factors obtained from our own data, much information was provided to us by the Consortium Catalogue from observations of the same individuals elsewhere.

In this paper, the term 'occurrence' refers to the temporal distribution of individually identified whales, expressed as the number of separate days on which each whale was observed during a given year. This differs from the term 'residency', which refers to the period (in days) between the first and last observation of an individual in a year. Throughout the paper, the data from the summer of 1986 have been treated separately in order to describe more accurately the characteristics of the unusual summer residency group.

RESULTS

Seasonal abundance and distribution

During the entire study period, there were 2,643 sightings totalling 113 individual right whales identified by photographs taken during 4,903 4-hour cruises. Total numbers of sightings, four-hour trips and individual whales identified are summarised by month in Table 1. Sighting effort was much lower during the months of November through March than during the rest of the year. In 1984, 1985 and 1986, which had year-round effort, the first sightings of the calendar year were on 30 January, 7 March and 1 February respectively. Mother/calf pairs were observed every year from 1984 to 1986, and in three of the earlier seven years. In all cases, the first observations of calves were in early to mid-April, with the earliest occurring on 8 April. Most right whales had left the study area by mid-May in all years except 1986, when a prolonged summer residency was observed. Photo-identification showed most (78%) of the 1986 summer residents to be whales that had not been sighted in the study area prior to mid-May of that year.

Table 1

Effort (4-hour trips), right whales sighted, individual whales identified, and identified individuals per unit effort, all shown by month: 1979–83, 1984–85 and 1986

	Years	Jan	Feb	Mar	Apr	May	Jun	Jul	Aug	Sep	Oct	Nov	Dec
4-hour Trips	1979-83	0	0	2	175	499	424	295	306	294	228	21	3
	1984-85	10	11	38	122	191	237	323	336	209	142	13	11
	1986	3	17	19	55	134	158	214	209	133	65	1	7
No. of Sightings	1979-83	0	0	3	235	104	2	0	1	6	6	3	0
	1984-85	1	5	185	206	6	0	2	0	0	5	0	0
	1986	0	81	18	66	12	32	150	374	621	507	1	0
No. of Individuals	1979-83	0	0	0	32	23	2	0	0	2	4	2	0
	1984-85	1	4	32	45	3	0	1	0	0	1	0	0
	1986	0	15	6	12	2	4	9	16	14	14	0	0
Individual/ Trip	1979-83	0	0	0	0.18	0.04	0	0	0	0	0.01	0.09	0
	1984-85	0.1	0.36	0.84	0.36	0.01	0	0	0	0	0	0	0
	1986	0	0.88	0.31	0.21	0.01	0.02	0.04	0.07	0.1	0.21	0	0

The yearly observed distribution of right whales in Cape Cod Bay has remained relatively stable, and is broadly represented by the 1984 sightings plotted in Fig. 2. The major concentrations have been seen in the eastern part of Cape Cod Bay, and most of our effort has been concentrated there during the peak season. However, occasional groups have been seen in Massachusetts Bay and concentrations were found both north and east of Cape Cod in 1985 and in 1986. The April 1985 observation of right whales west of Stellwagen Bank was in an area that had not been covered previously. The 1986 sightings (Fig. 3) made outside Cape Cod Bay were in an area and at a time of year during which there has been extensive effort since 1977.

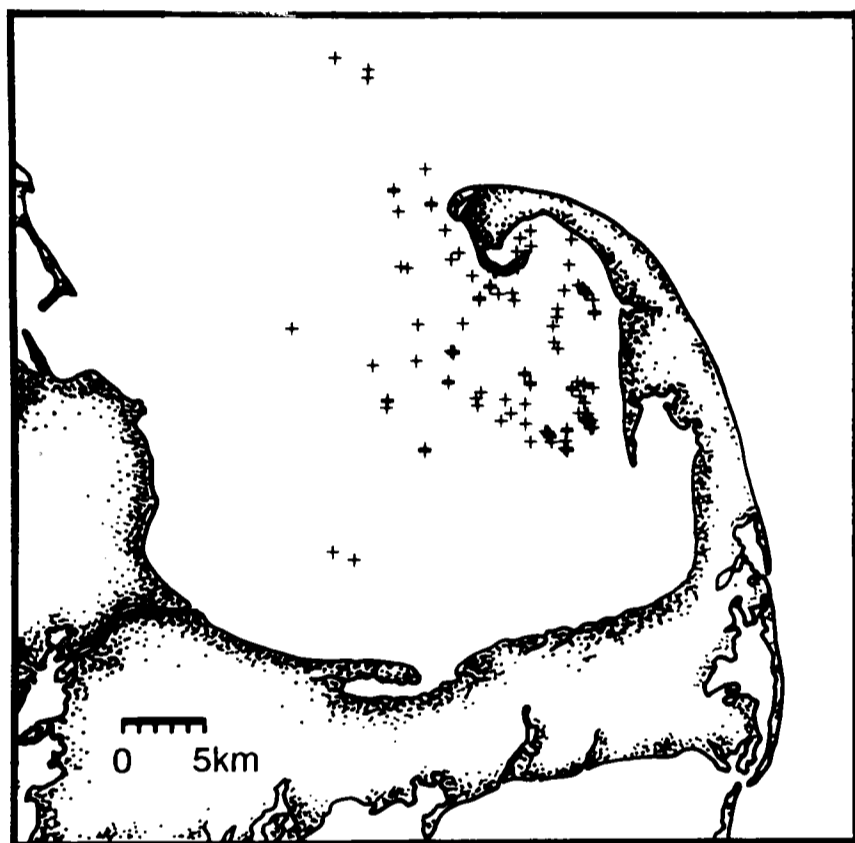

Fig. 2. Distribution of all 1984 right whale sightings. Each '+' represents one whale.



Fig. 3. Distribution of all 1986 right whale sightings. Each '+' represents one whale.

Occurrence, residency and resighting of identified individuals

A total of 113 individual right whales were identified during this study. Although our analysis of the gender and maturational class of individuals is incomplete, it shows that whales of all classes have been observed in the study area (Table 2). The data suggest no difference in occurrence or residency by age class or gender other than that mothers with calves do not arrive until after the first week of April. Of the 113 individuals observed, the sex of 60 (53%) was determined: of these, 39 (65%) were females, and 21 (35%) were males. Most females were identified by their association with a calf rather than by a photograph of the genital area. Because it is easier to identify females, no information on the sex ratio of animals in the area can be inferred from these values. Of the eight calves observed in the summer of 1986, five were males, two were females and the sex of the other was not determined. We were unable to determine the sex of calves observed in other years, largely because they were observed much less frequently than those in 1986.

Occurrence and residency varied considerably among individuals. From 1984 through the spring of 1986, the minimum number of separate days on which a whale was observed in a year was one and the maximum was 12

Table 2

Photographically identified right whales observed in Cape Cod waters, including new whales (animals not observed in previous years), and sex and maturational class, where known.

	Identified individuals			Sex		Maturational class			
	Tot	New	Res	F	M	C	J	A	5-6
1978	1	1	0						
1979	4	4	0	4					
1980	5	5	0	2		2			
1981	2	2	0	1					
1982	11	9	2	7		3	1	5	
1983	27	24	3	10	3	5	3	8	
1984	28	18	10	11	7	3	9	7	
1985	44	23	21	18	5	4	6	17	1
1986	47	27	20	19	11	8	5	12	2
TOTAL	169	113	56	72	26	25	24	49	3

Tot=Total; Res=Resighted; F=Female; M=Male; C=Calf; J=Juvenile; A=Adult; 5-6=5-6 years

Note: Figures for sex and maturational class do not necessarily represent the same individuals (e.g. the two calves in 1980 were not necessarily the whales sexed as females in that year).

(mean=2.4, SE=1.9). Prior to the summer of 1986, the longest observed residency was one of 89 days (mean=11.8, SE=18.2, median=45). Although our definition of residency does not account for the sighting gaps which usually occur between the first and last

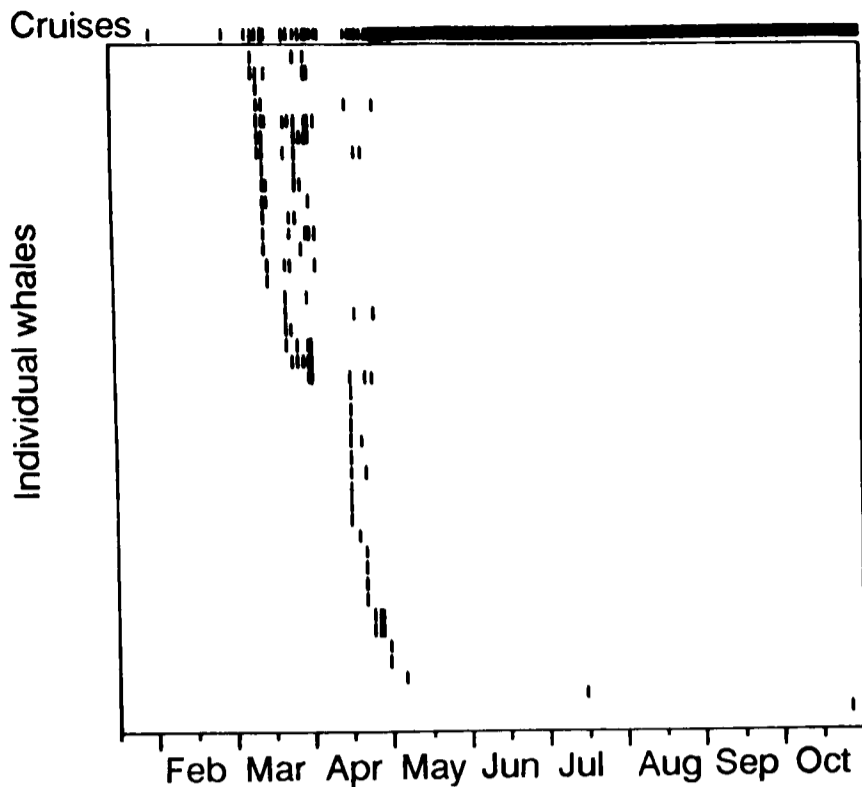

Fig. 4. Occurrence diagram for individual right whales observed in Cape Cod waters in 1985. The solid bar represents trips on the whale-watch vessels.

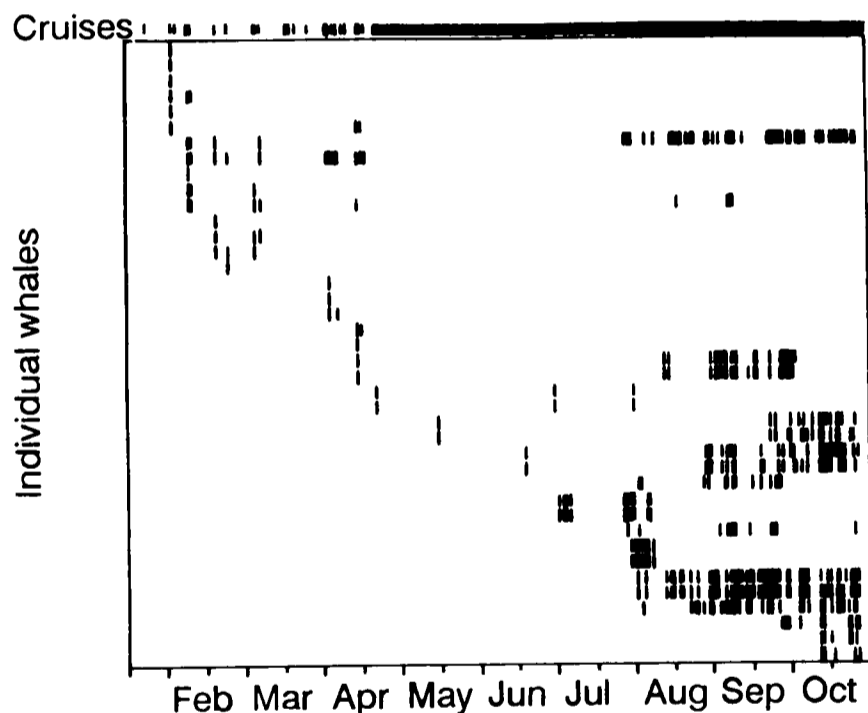

Fig. 5. Occurrence diagram for individual right whales observed in Cape Cod waters in 1986. The solid bar represents trips on the whale-watch vessels.

sightings, it does give an indication of the temporal distribution of whales in the general area. In 1986 (the only year of the study period when right whales were resident during the summer), 23 whales remained in the area from June through October. Sixteen (70%) were mothers and calves whose residencies ranged from 11 to 165 days (mean=93.6, SE=54.2). Figs 4 and 5 show the observed occurrence of individuals in 1985 (a typical year), and in 1986 (atypical), respectively.

Of the 86 individuals photographed prior to 1986, 43 (50%) were observed in more than one year. Individuals were observed in two years ($n=31$), three years ($n=11$) and four years ($n=1$). Table 2 summarises sighting data on all identified individuals.

Reproduction and recruitment

Between 1979 and 1987, 21 cows (females with calves) were observed in the study area with a total of 30 calves. Nine of the 21 had two calves during this period. The observed calving intervals were two years ($n=1$), three years ($n=7$) and four years ($n=1$), giving a mean interval of three years ($SD=0.5$). These calving intervals are consistent with figures from other areas (Kraus *et al.*, 1986a; Payne, 1986). Of the 24 identified calves born prior to 1987, seven (29%) have been subsequently seen in the study area as juveniles or adults. Eleven females were sighted in the year prior to calving; three of these were observed in surface-active groups.

Habitat use

The area was used for feeding, nursing and apparent courtship activity. Surface skim feeding (characterised by part or all of the rostrum above the water, and mouth gaped) was noted in 137 of 2,643 sightings. That this is also a nursery area was indicated by observations of calves with their mouths near the area of the mother's genital slit, and by the small size of the calves. As noted earlier, after their late arrival, mothers and calves usually remained in the bays for only short periods, except for during the atypical summer of 1986, when they remained for up to three months. Surface active groups, characterised by two or more animals rolling and exhibiting prolonged body contact, often with a female lying inverted with genitals above water, were observed on 136 occasions, all during late winter and early spring.

Group size

Animals were considered associated if they were close together and were generally coordinating at least their direction, speed of movement and their surfacing and diving behaviour. Of those groups observed closely enough to determine the group size ($n=1,802$), 1,164 (64%) were singles, 571 (32%) were pairs (including cow/calf pairs), 52 (3%) were groups of three, nine (0.5%) were groups of four and six (0.3%) were groups of five.

DISCUSSION

The observed pattern of occurrence of right whales in Cape Cod and Massachusetts Bays agrees with that suggested by the literature. Historically, catches of right whales were made in this area in late fall, winter and spring (Allen, 1916). Whaling records examined by Reeves and Mitchell (1987) suggest that whales were abundant in December and January. Recent observations (Schevill *et al.*, 1986; Winn *et al.*, 1986) suggested a peak abundance (including mothers with calves) in April and early May, with sporadic sightings during other months; this concurred with Mead's (1986) review of catches, strandings and sightings. Our data confirm this pattern, and indicate that concentrations of whales occur in the region as early as February and March (Table 1). Although our effort in Cape Cod Bay during the late fall was limited, it suggests that if whales are present, they are few in number (Table 1).

Our data confirm the impression obtained from historic and more recent data that the Cape Cod Bay and Massachusetts Bay area is of seasonal importance to right whales. Schevill *et al.* (1986) reported 131 individuals observed in 1961 and over 70 whales seen on a single day in April 1970. Our late winter and spring data for consecutive years, while yielding smaller numbers than those from

above by Schevill *et al.*, suggest that an abundance of right whales in this area at this time is a consistent rather than an occasional phenomenon. Furthermore, the number of individuals (113) that we have recorded to date represents 44% of the total North Atlantic Right Whale Catalogue (S. Kraus, pers. comm.). The fact that almost half the catalogued population visits the area indicates that these bays represent important habitats for the right whale.

The frequency with which we observed surface feeding, first-year calves and surface active groups (often associated with sexual behaviour) reveal that the area is important for feeding, nursing and possibly mating. Watkins and Schevill (1982) reported some evidence that calving occurs in Cape Cod waters. During our shorter study period, we have seen no indication of calving (e.g. within a season a whale has not been seen first alone and then with a calf). Several observers (Watkins and Schevill, 1982; Winn *et al.*, 1986; Kraus *et al.*, 1986a) have reported 'social' groups of right whales at various locations and at various times of year, yet the calving period is apparently restricted to winter (CeTAP, 1982; Kraus *et al.*, 1986b). Assuming a gestation period of about 12 months (see review in Lockyer, 1984), then our study area meets the criterion for a possible mating area, i.e. an area where sexual behaviour is observed during winter. The sighting of eleven females in the area the year before calving, with three of them observed in surface active groups, lends support to this. However, the present uncertainty concerning the gestation period and the sexual behaviour of this species precludes any more definitive statement on this area with respect to mating.

Finally, we would like to comment on the summer residency group observed in 1986. Our data (Table 1), those from whalewatching vessels which have operated in the area since 1977 and other published data (Mead, 1986; Schevill *et al.*, 1986; Reeves and Mitchell, 1987) reveal this to be atypical for the area. Kraus *et al.* (1986a) describe a summer nursery group in the Bay of Fundy. We believe that our 1986 group may have consisted of some of these animals residing south of their more usual location. The 1986 group exhibited similar patterns of arrival and composition to that observed in the Bay of Fundy between July and October every year. The 1986 summer occurrence of whales and their distribution (together with the 1985 occurrence in Massachusetts Bay) probably reflects the general flexibility in the distribution and occurrence of right whales in response to their prey, a theory suggested by Winn *et al.* (1986). The available information on prey species in 1986 therefore supports the view of Winn *et al.* (1986) that right whales can vary their relative use of preferred habitats such as the Bay of Fundy and our study area, in accordance with prey availability. These yearly variations may appear more dramatic when they occur in peripheral habitats such as Massachusetts Bay simply because these areas are used less consistently.

In this connection, the occurrence of the 1986 group coincided with a marked shift in the distribution of balaenopterid species in the area. Humpback whales (*Megaptera novaeangliae*), a piscivorous species, were rarely seen during the summer for the first time since our observations began in 1977. In contrast, sei whales (*Balaenoptera borealis*), previously absent, were observed throughout the summer. Sei whales and right whales appear to be broadly sympatric in certain areas (Mitchell, Kozicki and Reeves, 1986), probably due to similarity in prey preference (Nemoto, 1959; Kawamura, 1978;

Mitchell, 1975). During the summer of 1986, Mayo, Mattila, Pittman and Baraff (1987) conducted limited sampling of certain prey and environmental characteristics in the region. The results suggested a system-wide change in the distribution and abundance of prey, specifically a decrease in the availability of *Ammodytes americanus*, a formerly abundant prey species of humpback whales (Payne, Nicholas, O'Brien and Powers, 1986), and a concomitant rise in the abundance of calanoid copepods. This may explain the unusual presence of the right and sei whales, as calanoid copepods are the primary prey of both species.

ACKNOWLEDGEMENTS

We would like to acknowledge support for our studies since 1983 from the following: the Commonwealth of Massachusetts, National Marine Fisheries Service, the North Atlantic Right Whale Consortium, World Wildlife Fund-US, the Islands Foundation, the W. Alton Jones Foundation and the Ellis L. Phillips Foundation. Without the financial support of these organisations, the investigations over the years could not have continued.

We would also like to acknowledge contributions to the project from Steve Chelminski, Carole Carlson, Carol Danton, Mark Gilmore, Laurie Goldman, Marilyn Marx, Margaret Murphy, Irene Seipt and the captains and crew of the Dolphin Fleet. Thanks are also extended to Howard Winn and Bob Kenney of the University of Rhode Island and to Scott Kraus and Amy Knowlton of New England Aquarium whose collaboration and assistance have given us a better overview of right whale distribution and occurrence.

Finally, we are grateful for critical reviews of the paper by Phil Clapham, Greg Donovan, Bob Kenney, Scott Kraus and Howard Winn.

REFERENCES

- Aguilar, A. 1986. A review of old basque whaling and its effect on the right whales (*Eubalaena glacialis*) of the North Atlantic. *Rep. int. Whal. Commn* (special issue 10): 191-9.
- Allen, J.A. 1869. Catalogue of the mammals of Massachusetts: with a critical revision of the species. *Bull. Mus. Comp. Zool.* 1(8): 143-252.
- Allen, J.A. 1908. The North Atlantic right whale and its near allies. *Bull. Am. Mus. Nat. Hist.* 24(18): 277-329.
- Allen, G.M. 1916. The whalebone whales of New England. *Mem. Boston Soc. Nat. Hist.* 8: 107-322.
- CeTAP. 1982. A characterization of marine mammals and turtles in the mid- and North Atlantic areas of the US outer continental shelf. pp.57-80. Final report of the Cetacean and Turtle assessment program to the US Department of Interior under contract AA551-CT8-48.
- Kawamura, A. 1978. An interim consideration on a possible interspecific relation in southern baleen whales from the viewpoint of their food habits. *Rep. int. Whal. Commn* 28: 411-20.
- Kraus, S.D. 1985. A review of the status of right whales (*Eubalaena glacialis*) in the Western North Atlantic with a summary of research and management needs. Report to the US Marine Mammal Commission, Report No. MMC-84/08.
- Kraus, S.D., Moore, K.E., Price, K.A., Crone, M.J., Watkins, W.A., Winn, H.E. and Prescott, J.H. 1986a. The use of photographs to identify individual North Atlantic right whales (*Eubalaena glacialis*). *Rep. int. Whal. Commn* (special issue 10): 145-51.
- Kraus, S.D. and Prescott, J.H. 1985. Right whales (*Eubalaena glacialis*) in the Western North Atlantic: research progress from June 1984 to April 1985. Report submitted to World Wildlife Fund-US: 19pp.

- Kraus, S.D., Prescott, J.H., Knowlton, A.R. and Stone, G.S. 1986b. Migration and calving of right whales (*Eubalaena glacialis*) in the Western North Atlantic. *Rep. int. Whal. Commn* (special issue 10): 139-44.
- Lockyer, C. 1984. Review of baleen whale (Mysticeti) reproduction and implications for management. *Rep. int. Whal. Commn* (special issue 6): 27-50.
- Mayo, C.A., Mattila, D.K., Pittman, S. and Baraff, L. 1987. Abundance, distribution, and habitat use of large whales in the southern Gulf of Maine: May 1 - September 30, 1986. A report to the National Marine Fisheries Service. Contract No. 50-EANF-5-000130. pp.15-17.
- Mead, J.G. 1986. Twentieth century records of right whales (*Eubalaena glacialis*) in the Northwestern Atlantic Ocean. *Rep. int. Whal. Commn* (special issue 10): 109-20.
- Mitchell, E. 1975. Trophic relationships and competition for food in Northwest Atlantic whales. *Proc. Can. Soc. Zool.* (1974):123-33.
- Mitchell, E., Kozicki, V.M. and Reeves, R.R. 1986. Sightings of right whales, *Eubalaena glacialis*, on the Scotian Shelf, 1966-1972. *Rep. int. Whal. Commn* (special issue 10): 83-108.
- Nemoto, T. 1959. Food of baleen whales with reference to whale movements. *Sci. Rep. Whales Res. Inst., Tokyo* 14: 149-290.
- Payne, P.M., Nicholas, J.R., O'Brien, L. and Powers, K.D. 1986. The distributions of the humpback whale, *Megaptera novaeangliae*, on Georges Bank and in the Gulf of Maine in relation to densities of the sand eel, *Ammodytes americanus*. *Fish. Bull., US* 84(2): 271-7.
- Payne, R. 1986. Long term behavioural studies of the southern right whale (*Eubalaena australis*). *Rep. int. Whal. Commn* (special issue 10): 161-8.
- Payne, R., Brazier, O., Dorsey, E., Perkins, J., Rowntree, V. and Titus, A. 1983. External features in southern right whales (*Eubalaena australis*) and their use in identifying individuals. pp. 371-445, In: R. Payne (ed.) *Communication and Behavior of Whales*. AAAS Selected Symposium 76, Westview Press, Boulder, CO. 643pp.
- Payne, R. and Dorsey, E. 1983. Sexual dimorphism and aggressive use of callosities in right whales (*Eubalaena australis*). pp. 295-329. In: Payne, R. (ed.) *Communication and Behavior of Whales*. AAAS Selected Symposium 76, Westview Press, Boulder CO. 643pp.
- Reeves, R.R., Mead, J.G. and Katona, S. 1978. The right whale (*Eubalaena glacialis*) in the Western North Atlantic. *Rep. int. Whal. Commn* 28: 303-12.
- Reeves, R.R. and Mitchell, E. 1987. Shore whaling for right whales in the Northeastern United States. Report to the National Marine Fisheries Service, contract NA85-WC-C-06194.
- Schevill, W.E., Watkins, W.A. and Moore, K.E. 1986. Status of *Eubalaena glacialis* off Cape Cod. *Rep. int. Whal. Commn* (special issue 10): 79-82.
- Watkins, W.A. and Schevill, W.E. 1982. Observations of right whales (*Eubalaena glacialis*) in Cape Cod Waters. *Fish. Bull. US* 80(4): 875-80.
- Winn, H.E., Price, C.A. and Sorensen, P.W. 1986. The distributional biology of the right whale (*Eubalaena glacialis*) in the Western North Atlantic. *Rep. int. Whal. Commn* (special issue 10): 129-38.

Life History and Population Dynamics of Resident Killer Whales (*Orcinus orca*) in the Coastal Waters of British Columbia and Washington State

P. F. Olesiuk, M. A. Bigg and G. M. Ellis

Department of Fisheries and Oceans, Pacific Biological Station, Nanaimo, B.C., Canada V9R 5K6

ABSTRACT

Life history parameters are derived for the resident form of killer whale in the coastal waters of British Columbia and Washington State based on the demographic changes observed in two communities (closed to immigration and emigration) that were monitored between 1973–4 and 1987. Females have a mean life expectancy of 50.2 years, typically give birth to their first viable calf at 14.9 years of age, produce an average of 5.35 viable calves over a 25.2 year reproductive lifespan and have a maximum longevity of about 80–90 years. Calving is diffusely seasonal with most births occurring in October–March. Neonate mortality is approximately 43%. The estimated proportion of mature females pregnant varies from 0.274 in April to 0.411 in September. Males have a mean life expectancy of 29.2 years, typically attain sexual maturity at 15.0 years and physical maturity at 21.0 years of age, and have a maximum longevity of about 50–60 years. Mortality curves are U-shaped for both females and males, but the curve is narrower for males. There is no evidence of density dependence in the life history parameters as a result of cropping prior to the start of the study or as the populations increased during the study.

The derived life history parameters are used to develop a sex- and age-specific matrix population model and to calculate life tables. The model accurately emulates the demographic changes observed during the study. Population projections indicate that both communities represent stable populations below their carrying capacity. These populations had a finite annual rate of increase of 2.92% and were composed of 50% juveniles, 19% mature males, 21% reproductive females and 10% post-reproductive females. Discrepancies between the sex- and age-structure of the study populations and those of a stable population can be largely attributed to the selective cropping of pods prior to the start of the study. Simulations indicate that the population could sustain a maximum non-selective harvest of 2.84%; or maximum selective harvests of 4.70% of juveniles or 8.43% of adults, which represented total population harvest levels of 1.89% and 3.17% respectively. Sensitivity analyses reveal that populations are robust to changes in mortality rates, particularly adult mortality rates, which implies that density dependence is expressed primarily through changes in reproductive parameters. It is predicted that (1) a stationary population at carrying capacity will comprise 37% juveniles, 20% mature males, 14% reproductive females and 29% post-reproductive females; and (2) in a stationary population, females surviving to the end of their 14.0 year reproductive lifespan will produce an average of 2.0 calves.

CONTENTS

1.	INTRODUCTION	210	3.6	Mortality rates	227
2.	STUDY POPULATION	210	3.6.1	Methods	227
2.1	Data collection	210	3.6.2	Neonates	227
2.2	Sympatric forms	210	3.6.3	Juveniles.....	228
2.3	Resident communities.....	210	3.6.4	Mature males	228
2.3.1	Northern resident community	211	3.6.5	Reproductive females.....	229
2.3.2	Southern resident community.....	211	3.6.6	Post-reproductive females	229
2.4	History of exploitation	213	3.7	Density dependence	230
2.4.1	Historical kills	213	4.	POPULATION DYNAMICS	230
2.4.2	Live-capture fishery	213	4.1	Population projections	231
3.	LIFE HISTORY	214	4.1.1	The model	231
3.1	Age determination and longevity.....	214	4.1.2	Accuracy of the model.....	231
3.1.1	Juveniles.....	214	4.2	Stable population (below carrying capacity).....	231
3.1.2	Adult females	215	4.2.1	Life tables.....	232
3.1.3	Adult males	216	4.2.2	Life expectancy	232
3.1.4	Longevity	216	4.2.3	Stable (intrinsic) rate of increase	233
3.2	Calving and mating seasons.....	217	4.2.4	Reproductive potential and generation time.....	234
3.3	Age at maturity	218	4.2.5	Birth and death rates.....	234
3.3.1	Females.....	218	4.2.6	Stable sex- and age- structure.....	234
3.3.2	Males.....	218	4.2.7	Horizontal versus vertical analysis.....	235
3.4	Gross reproductive rates.....	221	4.2.8	Sustainable harvests	236
3.4.1	Multiplets	221	4.3	Stock assessment	237
3.4.2	Calving intervals	221	4.3.1	Methods	237
3.4.3	Fecundity rates	222	4.3.2	Northern community	237
3.4.4	Reproductive lifespan.....	222	4.3.3	Southern community	238
3.4.5	Fertility and pregnancy rates.....	223	4.4	Stationary population (at carrying capacity).....	239
3.5	Age-specific reproductive rates	224	4.4.1	Sensitivity analysis	239
3.5.1	Calving intervals	224	4.4.2	Stationary population parameters	241
3.5.2	Fecundity rates	224	ACKNOWLEDGEMENTS	241	
3.5.3	Reproductive senescence	225	REFERENCES.....	241	
3.5.4	Temporal changes in fecundity	226	APPENDIX	243	

I. INTRODUCTION

Our current understanding of the life history and population dynamics of cetaceans has been deduced largely from data collected from carcasses. However, this traditional approach has provided little insight into the life history of killer whales, *Orcinus orca* (IWC, 1982) for a number of reasons. First, relatively few specimens have been examined because the species has not been intensively exploited. Second, the commercial catches analyzed were size- or sex-selective and therefore not representative of the actual population (Nishiwaki and Handa, 1958; Jonsgård and Lyshoel, 1970; Christensen, 1982; 1984). Third, killer whales cannot be accurately aged beyond about age 20 years from teeth (IWC, 1980; Yochem, Myrick, Cornell and Arnell, 1987; Myrick, Yochem and Cornell, 1988).

The development of photo-identification techniques has offered a second approach for assessing the life history and population dynamics of cetaceans. Photo-identification studies of killer whales have been underway in coastal waters off British Columbia and Washington State since the early 1970s (Balcomb, Boran and Heimlich, 1982; Bigg, 1982). This has provided a unique perspective of the life history and population dynamics of this species (Bigg, 1982). All members of the two communities of the resident form of killer whale inhabiting this area, both of which are closed to immigration and emigration, have been identified and monitored annually since 1973–74. Genealogical trees have also been constructed for each community (Bigg, Olesiuk, Ellis, Ford and Balcomb, 1990), which can be used to age individuals. Thus, the study has provided a complete record of the number of viable births, deaths and total size of the two communities as well as information on the age, growth, maturity and calving histories of their constituent individuals.

In this report, we describe the life history of the resident form of killer whale in coastal waters off British Columbia and Washington State. The analysis was based on

demographic changes observed in the two resident populations during 1973–87. The life history parameters were used to develop an age- and sex-structured population model. We assessed the validity of the model by how well it emulated the observed demographic changes in the study population. The model was subsequently used to: (1) derive population parameters; (2) estimate sustainable harvests; (3) assess the impact of a live-capture fishery conducted prior to the study on local stocks; and (4) examine the sensitivity of the population to changes in life history parameters so as to identify likely mechanisms of population regulation. Finally, the life history and population parameters of killer whales were compared to those of other cetaceans, particularly pilot whales (*Globicephala* spp.).

2. STUDY POPULATION

2.1 Data collection

Data collection procedures were described in detail in Bigg *et al.* (1990) and are thus only outlined briefly here.

The study was based on repeated observations of individual whales, all of which could be recognized from the distinctive features of their dorsal fin and saddle patch. Each individual was assigned an alpha-numeric code. A single letter designated its pod and a two-digit number its identity within the pod. The identities of all individuals and their pods are given in Appendix Tables A and B in Bigg *et al.* (1990).

The study was conducted in coastal waters of British Columbia and Washington State (Fig. 1) during 1973–87. The basic sampling unit was an encounter, during which the total number and identity of all individuals present was recorded along with information on their sex and relative size. Whales were encountered throughout the study area and in all months of the year, but the majority of encounters occurred during July–September when the whales congregated in core areas such as Johnstone and Haro Straits. Thus, the encounters essentially represented an annual summer census of the population.

2.2 Sympatric forms

Two distinct forms of killer whale inhabited the study area (Bigg Ford and Ellis, 1985; Bigg, Ellis, Ford and Balcomb, 1987). The two forms, known as residents and transients, differed in morphological appearance and behaviour (Bigg *et al.*, 1985; 1987; Baird and Stacey, 1988; Heimlich-Boran, J.R., 1988; Morton, 1990). The two forms were sympatric, but appeared to be socially isolated as whales of one form were never observed to associate with whales of the other form. The resident form, which constituted 75% of all the individuals identified in the study area, was the most abundant form.

2.3 Resident communities

The resident killer whales inhabiting coastal waters off British Columbia and Washington comprise two geographic communities: the northern and the southern resident communities (Bigg, 1982; Bigg *et al.*, 1990).

Pods from each community were observed in the study area in all months of the year, which indicated that the communities were non-migratory. Pods belonging to one community only occasionally ventured into the range of the other and, although pods within each community often associated with each other, pods never associated with pods outside their community. The two communities were therefore geographically isolated from one another.

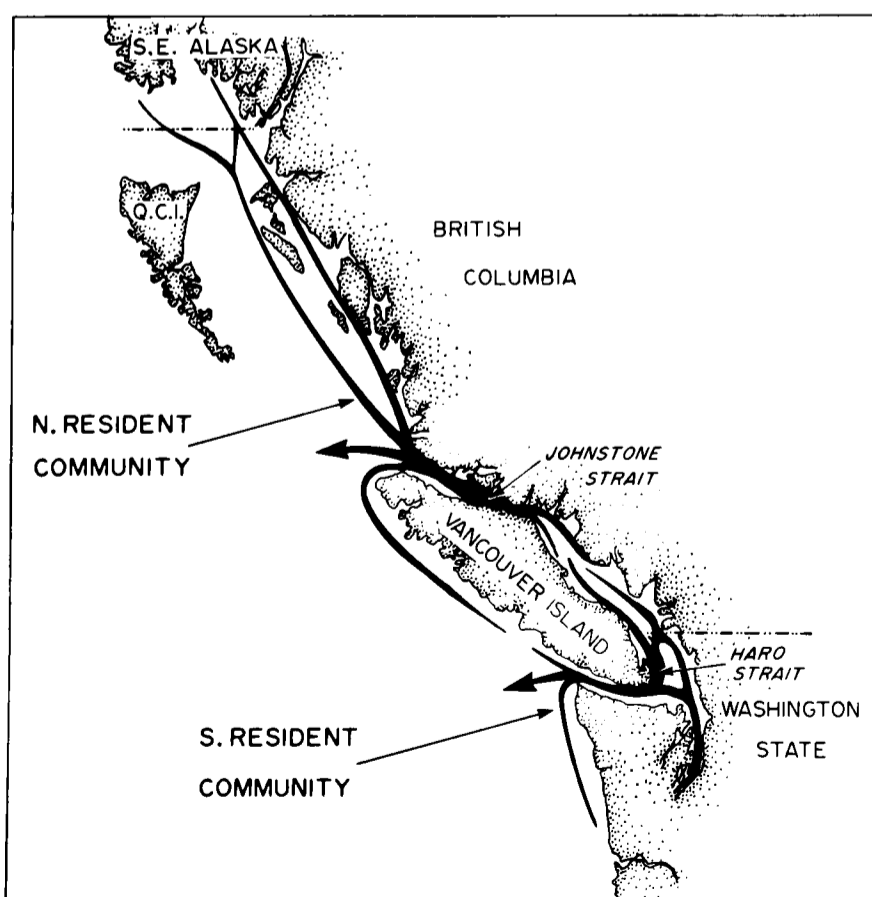

Fig. 1. Study area and the geographic ranges of the southern and northern resident communities and core areas (Johnstone and Haro Straits).

Interchange of individuals between the northern and southern communities has not been observed (Bigg *et al.*, 1990). Furthermore, photo-identification studies in southeast Alaska and Prince William Sound indicated that pods belonging to the northern community did not venture north of southern southeast Alaska and that the Alaskan resident pods did not venture into British Columbia (Leatherwood, Balcomb, Matkin and Ellis, 1984). Indeed, Bigg *et al.* (1990) concluded that resident whales of both sexes remained in their natal pod throughout life. Thus, each community was considered to be a separate population that was closed to immigration and emigration.

2.3.1 Northern resident community

The northern resident community ranged through coastal waters of northern British Columbia south to the mid-latitudes of Vancouver Island (Fig. 1). Northern residents were encountered on 660 occasions, during which a total of 16 pods was identified (Bigg *et al.*, 1990). Excluding animals born during the study, all members of the 16 pods had been identified by the 1979 field season (Fig. 2). Indeed, all but the smallest pod (W01), which comprised four individuals, had been identified by 1975. Despite intensive sampling effort (see Bigg *et al.*, 1990), no new pods belonging to this community have been discovered since 1979.

Not all of the northern pods were encountered every year. On average, pods were seen in 81.7% of the years between the years they were first and last encountered (Table 1). In most cases, a pod not seen in a particular year was seen the following year. However, in seven instances pods were not seen for two consecutive years and in one instance a pod was not seen for three consecutive years.

The smallest pod (W01) varied in size from 3–4 individuals during the study and the largest pod (G01) varied in size from 17–24 individuals (Table 1). The mean size of all pods over the course of the study was 9.7 animals. Between the first complete census of all the northern pods in 1979 and the last complete census of all pods in 1986, the community increased from 140 to 171 individuals, which represented a mean annual rate of increase of 2.90%. Using those pods that were censused as an index of changes in pod size, we projected the total size of the northern community prior to and following the last complete census of all pods. Assuming that the censused pods were representative of all pods, we estimated the total size of the community in a given year, N_t , by:

$$N_t = N_{t\pm 1} \cdot n_t / n_{t\pm 1} \quad (1)$$

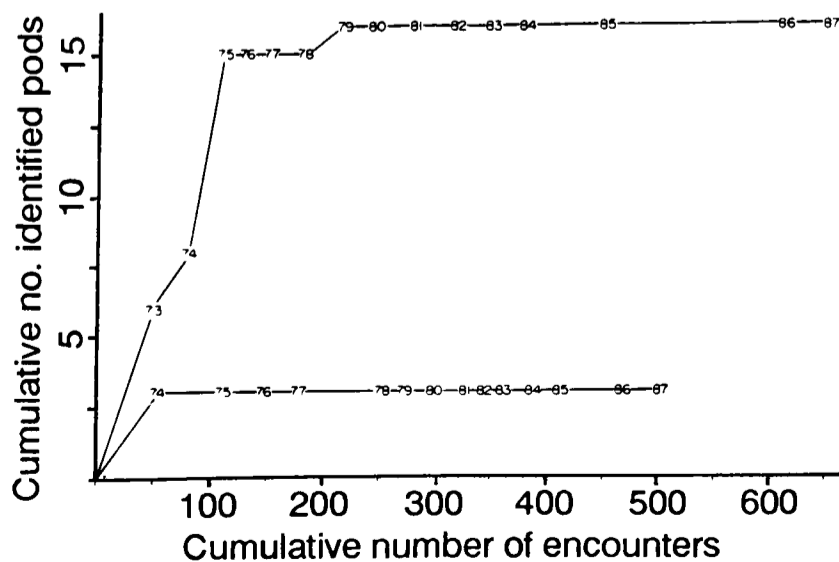

Fig. 2. Rate of identification of new pods as a function of year and cumulative number of encounters in the southern community (lower) and northern community (upper).

where n_t and $n_{t\pm 1}$ represent the total number of animals in the censused pods in years t and $t\pm 1$ respectively and $N_{t\pm 1}$ the estimated or known total size of the community in the preceding or proceeding year. A log-linear regression fitted to these estimates indicated that the northern community was increasing at a relatively constant finite rate of 2.62% ($r^2=0.964$; $P<0.01$) between 1973–87 (Fig. 3).

2.3.2 Southern resident community

The southern resident community ranged through the coastal waters of Washington State and southern British Columbia (Fig. 1). The southern residents were encountered on 502 occasions, during which a total of three pods were identified (Bigg *et al.*, 1990). All members of the three pods, excluding those born during the study, were identified by the end of the first southern field season in 1974 (Fig. 2). Despite intensive sampling effort (see Bigg *et al.*, 1990), no new pods belonging to this community have been discovered since 1974. The three southern community pods were encountered every year since 1974. The smallest pod (K01) varied in size from 14–17 individuals and the largest pod (L01) varied from 39–49 individuals (Table 2). The mean size of all pods over the course of the study was 26.0 individuals.

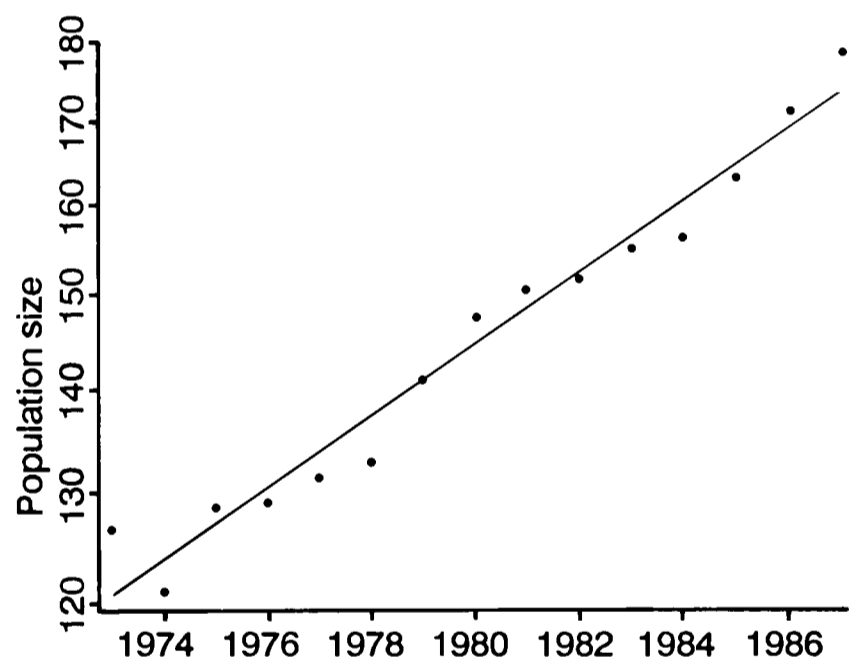

Fig. 3. Population trends in the northern resident community during the study, 1973–87. Note that population size is plotted on a logarithmic scale. The solid line represents a least squares log-linear regression fitted to the data.

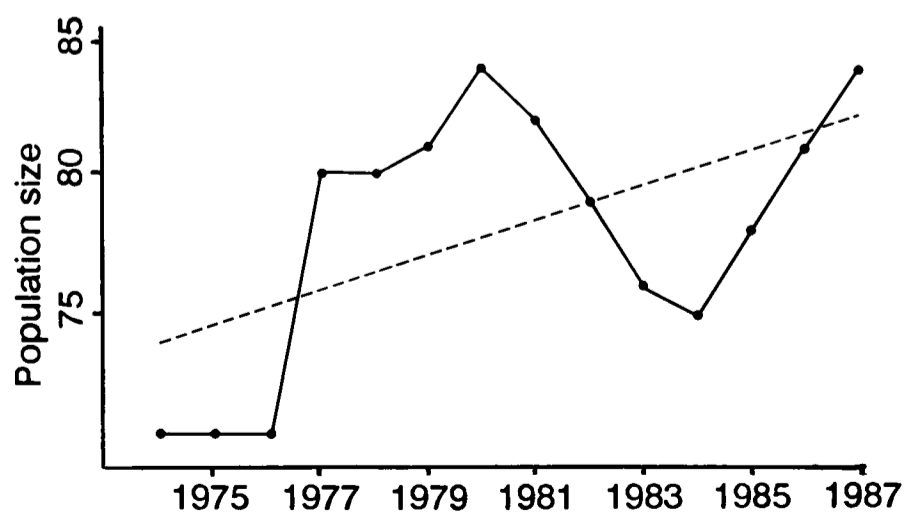

Fig. 4. Population trends in the southern resident community during the study, 1974–87. Note that population size is plotted on a logarithmic scale. The dashed line represents a least squares log-linear regression fitted to the data.

Table 1

Summary of the number of encounters, births, deaths, and size of the 16 northern resident pods during the study. Asterisks denote the first and last complete census of the pod. Births and deaths are given in the year they were first observed. For example, a death reported for 1984 occurred sometime between the 1983 and 1984 field seasons.

Pod:		<1973:	73:	74:	75:	76:	77:	78:	79:	80:	81:	82:	83:	84:	85:	86:	87:	Total:
A01	Encounters:	2	26*	8	9	10	0	19	26	1	19	23	17	18	29	108	16	331
	Births:	-	1	0	2	0	1	0	0	0	1	1	0	1	0	0	0	7
	Deaths:	-	-	0	1	1	0	0	0	1	0	0	0	1	0	0	0	4
	Size:	-	13	13	14	13	14	14	14	13	14	15	15	15	15	15	15	+2
A04	Encounters:	0	6*	3	5	7	3	10	15	8	13	16	7	8	16	40	8*	165
	Births:	-	1	1	0	0	0	1	0	0	0	0	3	0	1	0	1	8
	Deaths:	-	-	1	0	0	0	0	0	0	0	0	0	2	1	0	1	5
	Size:	-	5	5	5	5	5	6	6	6	6	6	9	7	7	7	7	+2
A05	Encounters:	4	15*	12	20	8	12	13	23	14	22	18	7	10	32	92	15*	317
	Births:	-	0	1	0	0	1	0	1	1	1	0	0	0	0	1	0	6
	Deaths:	-	-	1	0	0	0	1	0	0	1	0	0	0	0	0	0	3
	Size:	-	10	10	10	10	11	10	11	12	12	12	12	12	12	13	13	+3
B01	Encounters:	2	22*	7	0	1	6	4	3	9	7	11	5	1	2	28	1*	109
	Births:	-	1	0	0	0	0	0	1	0	0	0	0	1	0	0	1	4
	Deaths:	-	-	1	0	0	0	0	0	0	0	0	1	0	0	1	0	3
	Size:	-	8	7	7	7	7	7	8	8	8	8	7	8	8	7	8	0
C01	Encounters:	2	4*	3	2	0	4	5	0	5	1	7	5	10	6	65	11*	130
	Births:	-	0	0	1	0	0	0	1	0	0	0	0	0	2	0	0	4
	Deaths:	-	-	0	0	0	0	0	0	0	1 ¹	1 ²	0	0	1	0	2	5
	Size:	-	9	9	10	10	10	10	11	11	10	9	9	9	10	10	8	-1
D01	Encounters:	0	5*	1	6	0	0	5	0	10	2	3	1	7	5	44	8*	97
	Births:	-	0	0	1	0	0	1	0	0	0	1	0	1	0	0	3	7
	Deaths:	-	-	0	0	0	0	0	0	0	0	1	1	0	1	0	0	3
	Size:	-	8	8	9	9	9	10	10	10	10	10	9	10	9	9	12	+4
G01	Encounters:	0	3	3*	5	1	7	5	0	3	4	8	9	5	9	15	5*	82
	Births:	-	-	0	1	1	0	0	1	1	1	1	0	1	0	2	1	10
	Deaths:	-	-	-	0	0	0	0	1 ³	0	0	1	0	0	0	0	0	2
	Size:	-	-	16	17	18	18	18	18	19	20	20	20	21	21	23	24 ⁷	+8
G12	Encounters:	1	1	3*	4	1	2	0	0	1	2	1	0	0	4	2*	0 ⁷	22
	Births:	-	-	1	0	0	1	1	0	0	1	0	0	0	2	1	≥1	8
	Deaths:	-	-	-	0	0	0	0	0	0	0	0	0	0	0	0	≥0	0
	Size:	-	-	4	4	4	5	6	6	6	7	7	7	7	9	10	-	+7
H01	Encounters:	1	1	4	5*	0	2	4	3	1	3	8	0	2	6	32	2*	74
	Births:	-	-	-	1	0	0	0	0	0	1	0	0	0	0	1	0	3
	Deaths:	-	-	-	-	0	0	0	0	0	0	0	1	0	0	0	0	1
	Size:	-	-	-	6	6	6	6	6	6	7	7	6	6	6	7	7	+1
I01	Encounters:	0	1	0	2*	1	1	0	6	3	0	3	0	0	0	2*	0	19
	Births:	-	-	-	0	0	0	0	0	1	0	0	1	0	0	1	-	3
	Deaths:	-	-	-	-	0	0	0	0	0	0	0	0	0	0	0	-	0
	Size:	-	-	-	4	4	4	4	4	5	5	5	6	6	6	7	-	+3
I02	Encounters:	0	0	0	2*	0	1	0	5	4	2	4	2	2	4	11	1*	38
	Births:	-	-	-	0	0	0	0	0	1	0	0	0	0	0	0	1	2
	Deaths:	-	-	-	-	0	0	0	0	0	0	0	0	0	0	0	0	0
	Size:	-	-	-	6	6	6	6	6	7	7	7	7	7	8	8	+2	0
I11	Encounters:	2	2	2	4*	0	0	6	0	3	4	5	6	0	3	14	3*	54
	Births:	-	-	-	0	0	0	0	1	2	0	0	2	0	2	1	0	8
	Deaths:	-	-	-	-	1 ⁴	0	0	0	0	0	0	0	0	0	0	0	1
	Size:	-	-	-	7	6	6	6	7	9	9	9	11	11	13	14	14	+7
I18	Encounters:	0	0	0	2*	0	1	0	2	2	1	3	0	0	3	4*	0	18
	Births:	-	-	-	1	1	0	0	2	1	0	0	2	0	0	2	-	9
	Deaths:	-	-	-	-	0	0	0	0	0	0	0	0	0	0	0	-	0
	Size:	-	-	-	5	6	6	6	8	9	9	9	11	11	11	13	-	+8
I31	Encounters:	1	0	0	4*	0	0	2	0	0	4	4	4	2	5	24	6*	56
	Births:	-	-	-	0	0	0	0	0	1	0	0	0	0	2	0	0	3
	Deaths:	-	-	-	-	0	0	0	0	0	0	0	0	0	0	0	0	0
	Size:	-	-	-	4	4	4	4	4	5	5	5	5	5	7	7	7	+3
R01	Encounters:	0	0	0	2*	0	1	0	2	0	2	1	2	4	8	6	4*	32
	Births:	-	-	-	1	0	0	0	2	0	0	1	0	1	1	0	2	8
	Deaths:	-	-	-	-	2 ^{5,6}	0	0	0	0	0	0	1	0	0	0	1	4
	Size:	-	-	-	17	15	15	15	17	17	17	18	17	18	19	19	20	+3
W01	Encounters:	0	0	0	0	0	0	0	1*	0	3	7	5	1	3	2	2*	24
	Births:	-	-	-	-	-	-	-	0	0	0	0	0	0	0	0	0	0
	Deaths:	-	-	-	-	-	-	-	0	0	0	0	0	1	0	0	0	1
	Size:	-	-	-	-	-	-	-	4	4	4	4	4	3	3	3	3	-1
	Encounters:	11	39	31	34	14	26	29	39*	27	34	38	32	31	72	161*	42	660
	Births:	-	≥3	≥3 ⁷	≥8	≥2	≥3	≥3	9	8	5	4	8	5	10	9	≥10	≥90
	Deaths:	-	-	≥4 ⁷	≥1	≥4	≥0	≥1	1	1	2	3	4	4	3	1	≥4	≥33
	Size:	-	-	-	-	-	-	-	140	147	150	151	155	156	163	171	-	-

^{1,2,3,4,5,6} Exact year of death unknown. ¹ Died between 1981-82. ² Died between 1982-83. ³ Died between 1979-81. ⁴ Died between 1976-79. ⁵ One died between 1976-81. ⁶ Based on encounter of a portion of the pod. ⁷ Includes one individual that died before its pod was identified.

Between 1974 and 1987, the southern community increased in size from 71 to 84 individuals, which represented a mean annual rate of increase of 1.30% (Fig. 4). A log-linear regression indicated that the overall rate of increase was significantly greater than zero ($r^2=0.319$; $P<0.05$), but the rate of increase was not nearly as constant as that of the northern community. This was likely because: (1) the southern community, being about half the size of the northern community, was more sensitive to the stochastic nature of births and deaths; and (2) the sex- and age-structure of the southern community had been distorted by selective cropping prior to the start of the study (Sections 2.4.2 and 4.3.3).

2.4 History of exploitation

2.4.1 Historical kills

Prior to this century, killer whale populations in coastal waters off British Columbia and Washington State were probably in an unexploited state. Aboriginal utilization of killer whales appear to have been negligible. Although marine mammals were a common component of the fauna excavated at anthropological sites in the Pacific Northwest, only one killer whale has been identified (R. Wigen, University of Victoria, Victoria, British Columbia, pers. comm.). Their scarcity may have been due to the special mythological significance of killer whales in local aboriginal cultures (Cavanagh-Ford, 1984; Tanami, 1984). The journals of the early explorers of the west coast of Canada made no reference to the exploitation of killer whales.

Killer whales were never the target of commercial whalers in British Columbia or Washington State, but were occasionally taken incidentally to other species. The only documented commercial kill was a photograph of an adult male being processed at a local whaling station in 1955 (Pike and MacAskie, 1969).

Prior to about 1970, killer whales were viewed locally as a nuisance as it was believed they preyed on commercial fish stocks and posed a potential hazard to small vessels. During the 1940s, the Royal Canadian Air Force used killer whales for targets in practice bombings (Carl, 1946),

but no records were maintained on the magnitude or location of potential kills. In 1960, the Canadian Department of Fisheries installed a machine gun in the Strait of Georgia in an attempt to cull populations, but no whales were sighted while the station was operational (Pacific Biological Station, unpubl. data). Nevertheless, substantial numbers of killer whales may have been killed opportunistically by fishermen, fisheries personnel and sportsmen during this era. Bullet wounds were evident in up to 25% of the animals taken from the study area during the live-capture fishery (Keyes, *in* Hoyt, 1981). Shooting by fishermen was cited as the most likely cause of abnormally high mortality in a particular pod of killer whales in Prince William Sound, Alaska, that recently learned to remove cod from longlines (Matkin, Ellis, von Ziegessar and Steiner, 1986).

Since the early 1970s, local attitudes toward killer whales have changed dramatically. Recent surveys of the attitudes of commercial fishermen in British Columbia showed that few (11.3%) considered killer whales more than a minor problem (Olesiuk, unpubl. data). Killer whales have been protected in Canadian waters by the Fisheries Act since 1970 and in USA waters by the Marine Mammal Protection Act since 1972. However, several permits have been issued for the capture of specimens in Canada since the species was protected (Section 2.4.2).

2.4.2 Live-capture fishery

Between 1962 and 1977, a total of 68 killer whales were removed from the coastal waters of British Columbia and Washington State during a live-capture fishery, for exhibition in aquaria (Bigg and Wolman, 1975). Bigg (1982) identified the pods for 53 of the 68 (78%) animals taken. Of these, 48 (90.6%) were of the resident form. Since residents were the most abundant form in the study area, most if not all of the 15 remaining animals were probably also of the resident form. All but one of the 15 were captured within the range of the southern community. We therefore estimated that 63 (93%) of the animals cropped were residents and that the majority of residents (76%) were taken from the southern community.

Table 2

Summary of the number of encounters, births, deaths, and size of the three southern resident pods during the study. Asterisks denote first and last complete census of the pod. Births and deaths are given in the year they were first observed.

Pod:		<1973:	73:	74:	75:	76:	77:	78:	79:	80:	81:	82:	83:	84:	85:	86:	87:	Total:
J01	Encounters:	5	0	25*	40	20	17	62	14	21	20	10	9	9	11	31	17*	311
	Births:			1	0	1	1	1	1	0	1	1	0	0	1	0	1	9
	Deaths:	-	-	-	0	0	0	0	0	0	1	1	0	1	0	2	0	5
	Size:	-	-	15	15	16	17	18	19	19	19	19	19	18	19	17	18	+3
K01	Encounters:	3	1	17*	25	2	8	40	6	8	8	9	7	19	16	37	14*	240
	Births:	-	-	1	0	0	1	0	0	0	0	0	0	0	1	2	1	6
	Deaths:	-	-	-	1	1	0	0	0	0	0	1	1	0	1	0	0	5
	Size:	-	-	17	16	15	16	16	16	16	16	15	14	14	14	16	17	0
L01	Encounters:	4	1	12*	21	16	14	31	3	9	14	8	9	9	11	20	16*	198
	Births:	-	-	3	1	0	6	1	1	3	0	0	0	3	3	5	2	28
	Deaths:	-	-	-	0	0	0	1	1	0	2	2	2	3	1	2	1	15
	Size:	-	-	39	40	40	46	46	46	49	47	45	43	43	45	48	49	+10
Encounters:		10	2	43*	58	37	30	75	19	26	29	16	16	27	25	57	32*	502
Births:				5	1	1	9 ¹	2	2	3	1	1	0	3	5	7	4	44
Deaths:				-	1	1	0	2 ¹	1	0	3	4	3	4	2	4	1	26
Size:				71	71	71	80	80	81	84	82	79	76	75	78	81	84	+13

¹ Includes one individual that died before its pod was identified.

In order to assess the impact of the live-capture fishery on each community, the approximate age-composition of the harvest was reconstructed based on the sex and size of the cropped animals (Table 3). Females and males both measured about 2.3m in length at birth (Section 3.2) and in captivity grew at a rate of about 0.35 m.yr⁻¹ (Bigg, 1982). Whales less than 3.5m in length were thus considered less than 4 years of age. Field observations of known-aged females (Bigg, unpubl. data) indicated that females approached adult-size by about 10 years of age. Given that females matured at about 4.6–4.9m (Christensen, 1982; 1984; IWC, 1982), we estimated that females measuring 3.5–4.5m were 4–10 years of age whereas those measuring more than 4.5m were older than 10 years of age. Field observations of known-aged males (Bigg, unpubl. data) indicated that males approached adult-female size by about 8 years of age and continued to grow until they were sexually mature at about 6m in length (Bigg, 1982) and 15 years of age (Section 3.3.2). Therefore, we estimated that males measuring 3.5–4.5m were 4–8 years of age, males 4.5–6m were 9–15 years of age, and males longer than 6m were older than 15 years of age.

Table 3

Summary of the number of killer whales captured or killed by pod, date, length (in metres) and sex (M, F, ?) during the live-capture fishery in British Columbia and Washington State (modified from Bigg, 1982).

Pod/Area	Caught	N	Physically immature			Mature			
			≤3.5m			≥4.5			
			M	F	?	M	F	M	?
S. Resident									
J01,K01,or L01	Jul 64	1	-	-	-	-	1	-	-
J01,K01,or L01	Oct 65	2	-	-	-	1	-	1	-
K01	Feb 67	8	1	2	2	1	-	1	1
J01,L01	Oct 68	5	-	-	3	-	-	2	-
J01,K01,or L01	Aug 70	11	2	-	2	3	2	1	1
L01	Aug 71	3	-	1	-	1	1	-	-
J01	Mar 72	1	1	-	-	-	-	-	-
K01	Aug 73	1	-	-	-	-	-	1	-
L01	Aug 73	2	-	-	-	-	-	1	1
Total		34	4	3	2	9	5	5	1
N. Resident									
C01	Jun 65	1	-	-	-	-	-	-	1
I11	Jul 67	1	-	-	-	1	-	-	-
A(A05)	Apr 68	6	1	-	-	1	-	1	3
A05	Dec 69	6	-	2	-	2	1	-	-
Total		14	1	2	-	3	2	2	3
Transient									
M01	Mar 70	3	-	-	-	2	-	-	1
Q01	Aug 75	2	-	-	-	1	1	-	-
Total		5	-	-	-	1	3	-	1
S. Vancouver I ¹	Sep 62	2	-	-	-	-	-	-	2
S. Vancouver I ¹	Jul 66	1	1	-	-	-	-	-	-
S. Vancouver I ¹	Feb 68	2	-	-	-	1	-	-	1
S. Vancouver I ¹	Apr 69	2	-	-	-	-	-	1	1
S. Vancouver I ¹	Oct 69	1	-	-	-	-	-	-	1
S. Vancouver I ¹	Feb 70	1	-	-	-	-	1	-	-
S. Vancouver I ¹	Aug 70	1	-	1	-	-	-	-	-
S. Vancouver I ¹	Aug 77	1	-	1	-	-	-	-	-
Washington ¹	Nov 71	2	-	-	-	2	-	-	-
Washington ¹	Mar 73	1	-	-	-	-	-	1	-
Total		14	1	2	-	3	-	1	3
NE Vancouver I ²	Jul 68	1	-	-	-	1	-	-	-
Grand Total		68	6	7	2	17	10	1	7

¹ Assume belonged to southern resident community.

² Assume belonged to northern resident community.

The above criteria indicated that the live-capture fishery was selective for physically immature animals, which accounted for 73% (46 of 63) of the total take of resident whales (Table 3). The take was also biased toward males, which represented 68% (40 of 59) of the cropped residents of known sex.

3. LIFE HISTORY

Life history parameters were estimated from demographic events observed between the first and last census of each pod (Tables 1 and 2). Where possible, life history parameters were derived separately and compared for cropped and uncropped pods to ascertain whether cropping had any discernible effect. Pods were classified as cropped if more than one individual was known to have been removed during the live-capture fishery. Since all three of the southern community pods, but only one of the northern community pods (A05) had been cropped, comparing cropped and uncropped pods was essentially equivalent to comparing the southern and northern communities.

3.1 Age determination and longevity

3.1.1 Juveniles

Calves born during the study were aged in reference to the year they were born. Since births generally occurred in October-March (Section 3.2) and most encounters were in July-September (Fig. 2 in Bigg *et al.*, 1990), animals were assumed to have been censused at their pivotal ages (i.e. the midpoint between birthdays). For example, an individual born between the 1973 and 1974 field seasons was assigned an age of 0.5 years in 1974, 1.5 years in 1975, etc. Ages estimated in this manner were thus considered accurate to within ±0.5 years.

Some calves born during the study in the northern pods that were not encountered every year may not have been seen in the year they were born. In cases where the mothers of new calves had not been seen in the preceding year(s), the calves were aged based on their body-size when first seen relative to that of known-aged juveniles. We judged that eight of the calves born during the study were first seen at 1.5 years of age and four each at 2.5 years and 3.5 years of age. Similarly, calves judged to have been born 1–3 years prior to the first encounter with their pod were aged based on their body-size when first seen. In cases where it was judged that a calf may have been born in either of two years, the birth was amortized over the period in question. For example, a calf that may have been born between either the 1973 and 1974 or the 1974 and 1975 field seasons was tallied as half a 1.5 year old and half a 2.5 year old in the 1976 census. Ages estimated in this manner were thus considered accurate to within ±1 year. Individuals aged by the above two methods are subsequently referred to as known-aged animals.

Most older juveniles were aged in reference to the year they matured, but four were aged based on their body-size when first seen. One individual (W05) that had not matured by the end of the study was judged to have been aged 5.5 years when first seen in 1979 and a female (K40) that remained barren during the study was judged to have been aged 9.5 years when first seen. In addition, two females (A24 and R04), judged to have been aged 5.5 and 10.5 years at the start of the study, were aged based on their body-size in photographs taken prior to the start of the study. One additional individual (B04) that died and

was recovered within a few days of first being encountered was aged at 11.5 years based on the number of dentinal annuli. These age estimates were considered accurate to within about ± 2 years.

3.1.2 Adult females

With the above noted exceptions, females that were large juveniles when first encountered were aged in reference to the year they gave birth to their first viable offspring. Viable offspring were defined as those that survived to at least 0.5 years of age. Age at first birth was established based on the ages at which known-aged females gave birth to their first viable calf (Section 3.3.1). The probability of a female being aged x in the year it gave birth to its first viable calf was estimated as:

$$\Pr(\text{Age}=x + 0.5) = r_{(x)} \quad (2)$$

where $r_{(x)}$ represents the proportion of known-aged females that first gave birth at age x (Table 6). The correction of 0.5 accounted for the fact that animals were censused at their pivotal ages. Age point estimates, X , were obtained from the age probability density function (2) by:

$$X = \sum_{x=12.5}^{18.5} x \cdot \Pr(\text{Age}=x) \quad (3)$$

Since females typically gave birth to their first viable offspring between 12 and 18 years of age (Section 3.3.1), the point estimates were considered accurate to within ± 3 years.

An extension of the above method was applied to females that were adult-sized when first seen and gave birth to their first known offspring during the study or had given birth prior to the start of the study. The calving histories of the latter were determined from the genealogical trees given in Bigg *et al.* (1990). If it was assumed that a female's oldest known offspring represented her first born, the year she first gave birth could be established from the age of her oldest offspring, and subsequently her age using equations (2) and (3). However, this tended to underestimate ages because females may have lost their first viable progeny prior to the start of the study.

We corrected for this bias by incorporating a probabilistic adjustment for calf loss in equation (2):

$$\Pr(\text{Age} = [x + \text{CI} \cdot N] + 0.5) = r_{(x)} \cdot \Pr(L = N) \quad (4)$$

where CI denotes the mean calving interval, 5.32 years (Section 3.4.2), and $\Pr(L = N)$ the probability that a female lost her first N offspring prior to the start of the study. For example, a female that lost her first offspring was assumed to have given birth to her first calf 5.32 years prior to the birth of her oldest known offspring, a female that lost her first two offspring was assumed to have given birth 10.64 years prior to the birth of her oldest known offspring, etc. Age point estimates corresponding to the age probability density function (4) were obtained using equation (3).

The probabilities of a female losing her first N progeny were calculated sequentially as follows:

$$\Pr(L \geq N) = 1 - \{\text{SURV}(\text{CI} + [Y_o - Y_f])\} \quad \text{for } N = 1 \quad (5)$$

$$\Pr(L \geq N) = \Pr(L \geq N-1) \cdot \{1 - \text{SURV}(N \cdot \text{CI} + [Y_o - Y_f])\} \quad \text{for } 1 < N \leq M \quad (6)$$

$$\Pr(L = N) = 1 - \Pr(L \geq 1) \quad \text{for } N=0 \quad (7)$$

$$\Pr(L = N) = \Pr(L \geq N) - \Pr(L \geq N + 1) \quad \text{for } 0 < N < M \quad (8)$$

$$\Pr(L = N) = \Pr(L \geq N) \quad \text{for } N=M \quad (9)$$

where Y_o denotes the estimated year of birth of the oldest known offspring, Y_f the year the female and its offspring were first encountered and M the maximum number of calves that could have been lost. Maximum calf loss, M , was set at five viable calves, the approximate number born during the reproductive lifespan (Section 3.5.3). Since $\Pr(L = N)$ diminished rapidly with N , this constraint had little effect on the age estimates. Given that the sex ratio was equal at birth (Section 3.6.3), the proportion of viable offspring that survived to age x , $\text{SURV}(x)$, was:

$$\text{SURV}(x) = \left[\int_{0.5}^x \text{SV}_{f(x)} + \int_{0.5}^x \text{SV}_{m(x)} \right] / 2 \quad (10)$$

where $\text{SV}_{f(x)}$ and $\text{SV}_{m(x)}$ represent the age-specific female and male survival rates respectively (Section 3.6).

The magnitude of the correction for the loss of offspring varied as a function of $Y_o - Y_f$, the age of a female's oldest offspring in the year she was first seen. Oldest progeny ranged in age from 1.5 to an estimated 40.2 years, which corresponded to corrections of 0.9 to 9.7 years. Accordingly, the accuracy of the age point estimates, nominally calculated as the minimum age interval over which the age probability density function (4) summed to 0.8, ranged from ± 3 years for females aged 20 when first seen, to ± 4 years for females aged 35 when first seen, to ± 8 years for females aged 50 when first seen.

The above ageing procedure involved four assumptions: (1) age at first birth had remained constant; (2) the genealogical trees given in Bigg *et al.* (1990) were accurate; (3) calving intervals had remained constant; and (4) survival rates had remained constant. The validity of the first assumption could not be directly evaluated because known-aged females only began to give birth late in the study. Consequently, the age estimates were subject to biases of the same magnitude as any shift that might have occurred in the mean age at first birth. However, considering that the age-structure of the study population conformed with that of a stable population (Section 4.3), and that the stable age-structure was sensitive to shifts in age at first birth (Section 4.4.1), it was unlikely this parameter had changed appreciably in recent years.

Inaccuracies in the genealogical trees derived in Bigg *et al.* (1990) were probably not an important source of bias. Eighteen (29.5%) of the age estimates were based on positive lineages, 30 (49.2%) on highly probable lineages and 13 (21.3%) on probable lineages. There were few sources of errors in the lineages at the positive and highly probable level of certainty (Bigg *et al.*, 1990). Moreover, most females had several similarly aged offspring so that a single incorrect lineage would have had little effect on the age estimates. Of the 13 females aged on the basis of probable lineages with their oldest offspring, 12 (92.3%) had at least one younger offspring, the age of which was an average of 7.6 years less than that of the oldest offspring. It should also be noted that the potential biases in the ages based on the probable lineages were of little consequence in the population model, as 11 of the 13 females were post-reproductive.

With respect to the final two assumptions, there was no way of independently estimating calving intervals and mortality rates prior to the start of the study. However, the net apparent fecundity rate, which represents the net product of fecundity and mortality, appeared to have been constant since at least 1955 (Section 3.5.4). This implied that both calving intervals and survival rates were constant, or that changes in one were balanced by reciprocal changes

in the other. In either case, the ages of females born after 1940, which included essentially all reproductive females, would have been unbiased.

Some discretion was used in applying the above ageing procedure to females in cropped pods. Because these females may have had progeny cropped, equation (10) tended to overestimate the survival rate of their progeny and hence underestimate their age. Since there was no way of establishing which females had progeny cropped, the ageing procedure was applied only to females: (1) that had at least four identified offspring; or (2) for which the birth dates of their identified offspring spanned at least 20 years. As females typically gave birth to about five calves over a 25 year reproductive lifespan (Section 3.5), individuals satisfying these criteria were unlikely to have had their first offspring cropped.

The females in cropped pods that failed to satisfy either of the above criteria were aged by one of two alternative methods. First, females that became post-reproductive just prior to or during the study were aged in reference to the year of birth of their last viable calf. Females were defined as post-reproductive when they had not calved for at least 10 years. The year of birth of post-reproductive females was estimated by subtracting 39, the mean age of females at last birth (Section 3.5.3), from the year of birth of their last offspring. Since only 10% of females were post-reproductive by 29 years of age and 90% were post-reproductive by 48 years of age (Section 3.5.3), ages estimated in this manner were considered accurate to within ± 10 years.

Second, the females in cropped pods that failed to meet either of the above criteria fell into two categories: (1) those that were reproductive during the study; and (2) those that gave birth to their last identified calf more than five years prior to the start of the study. There was no way of knowing whether the former were in the early stage of their reproductive lifespan and would give birth again in coming years, or were in their late stage but had their oldest progeny cropped. Similarly, there was no way of knowing whether the latter had been post-reproductive for a long time or had become post-reproductive just prior to the start of the study but had their youngest progeny cropped. Females in both categories were aged based on the mean birth date of their identified offspring, which we assumed coincided with the midpoint of their reproductive lifespan. Females typically gave birth to 50% of their calves by 24 years of age and had a mean reproductive lifespan of 25 years (Section 3.5.3). The accuracy of these age estimates varied depending on the number and span between the offspring used to calculate the mean birth date. For example, an estimate based on the mean birth date of one offspring was only accurate to within ± 12 years whereas an estimate based on two offspring born over a 15 year period was probably accurate to within about ± 5 years.

3.1.3 Adult males

Males that were large juveniles when first encountered were aged in reference to the year they attained sexual maturity. Age at onset of sexual maturity was established based on the rate of development of the dorsal fin (a secondary sexual characteristic) of known-aged males (Section 3.3.2). Assuming that age at maturity had remained constant, the probability that a male was aged x in the year it became sexually mature was:

$$\Pr(\text{Age}=x) = r_{m(x)} \quad (11)$$

where $r_{m(x)}$ represented the proportion of known-aged males that attained sexual maturity at age x (Table 7). Age point estimates, X , were obtained from the age probability density function (11) by:

$$X = \sum_{x=10.5}^{17.5} x \cdot \Pr(\text{Age} = x) \quad (12)$$

which coincided with the mean age at onset of sexual maturity. Since most males attained sexual maturity between 11.5 and 17.5 years of age, the point estimates were considered accurate to within ± 3 years.

Development of the male dorsal fin continued for about six years following the onset of sexual maturity, at which point males were referred to as physically mature (Section 3.3.2). Males that were sexually, but not physically, mature when first seen were aged in reference to the year they attained physical maturity. The probability that a male was aged x in the year it attained physical maturity was:

$$\Pr(\text{Age} = x + 6) = r_{m(x)} \quad (13)$$

and the corresponding point estimate, which coincided with the mean age at physical maturity, was obtained by equation (12). Since complete development of the fin actually required 4–8 years (Section 3.3.2), ages estimated in this manner were considered accurate to within ± 5 years.

We had no way of accurately ageing males that were physically mature when first encountered. Thus, their minimum ages were estimated by assuming that they had attained physical maturity in the year they were first seen. In some cases, the minimum ages of males were based on photographs taken prior to the start of the study. Minimum ages were denoted as $X+$.

3.1.4 Longevity

The point estimated ages of all individuals are given in Appendix Tables A and B in Bigg *et al.* (1990). The superscripts accompanying the age estimates in the Appendix Tables correspond to the ageing methods summarized in Table 4, and therefore indicate the accuracy of the age estimates. Although the age point estimates, particularly for older individuals, were subject to considerable inaccuracies (Table 4), these inaccuracies tended to negate one another at the population level. For example, while the ages of females that matured atypically early and/or whose progeny exhibited above average survival were overestimated, the ages of females that matured atypically late and/or whose progeny exhibited below average survival were underestimated. In effect, the inaccuracies at the individual level represented imprecision at the population level. This imprecision was accounted for in subsequent age-specific analyses by: (1) utilizing the probability density functions rather than the point estimates; or (2) grouping data into age categories, the width of which reflected the accuracy of the age estimates.

The ages of all females that were mature when the study began or matured during the study are shown in Fig. 5. Approximately half of the females attained ages of 35 years or greater during the study. Eight females (3 in uncropped and 5 in cropped pods), six of which were still alive in 1987, attained ages of greater than 60 years. The two oldest females were estimated to have been 76.5 and 77.5 years of age when last seen in 1987. Thus, maximum longevity of females likely extended to at least 80 years. The age probability density functions (4) for the oldest females indicated that several were possibly as old as 90 years of age (see also Section 4.2.6).

Table 4

Summary of the ageing methods used and the nominal accuracy of the age estimates. The letters denoting the basis of age estimate correspond with the superscripts accompanying the age estimates given in Appendix Tables A and B (Bigg *et al.*, 1990).

Basis of age estimate	Cropped			Uncropped			Acc.
	? M F	? M F	? M F				
(A) Year of birth known	34 8 7	48 6 7		±0.5			
(B) Year of birth estimated based on its size	1 3 3	27 1 3		±0.5			
	1 3 7	1 6 4		±1			
	0 0 1	0 2 2		±2			
(C) Year of first calf known	- - 4	- 9		±3			
(D) Year of first calf estimated from age of oldest known calf	- - 11	- 37		±3-10			
(E) Year of last calf known	- - 8	- - -		±10			
(F) Mean birth date of all calves	- - 17	- - -		±5-12			
(G) Year of sexual maturity known	- 8 -	19 -		±3			
(H) Year of physical maturity known	- 5 -	- 5 -		±5			
(I) Physically mature when first encountered	- 5 -	- 19 -		min.			

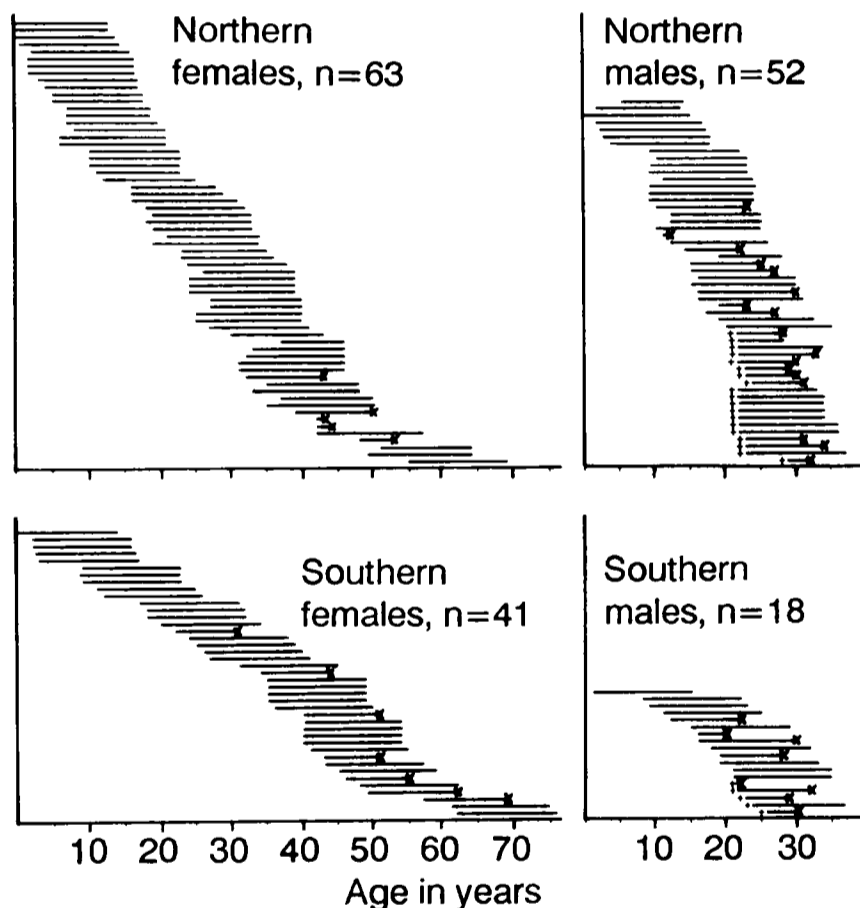

Fig. 5. Age point estimates for all mature individuals during the study in (a) the southern community and (b) the northern community. The Xs denote deaths and +s minimum ages.

Maximum longevity of males could not be directly established as only the minimum ages of the oldest males were ascertained. Nevertheless, it appeared that males were not as long-lived as females. Even if all minimum aged males are included, less than 25% of mature males attained ages of 35 years compared with 50% of mature females (Fig. 5). However, at least seven males, and possibly as many as 32, attained ages of 35 years or greater during the study. Maximum longevity of males therefore likely extended beyond 40 years. Life tables suggested that male longevity was likely on the order of 50-60 years (Section 4.2.6).

Our age estimates were considerably greater than those previously estimated from teeth. Mitchell (1975) reviewed earlier literature and noted that the oldest recorded killer whale, a female, was estimated to have been 25 years of age

based on the counts of dentinal growth layer groups (GLGs) (Caldwell and Brown, 1964). Participants at the IWC Ageing Workshop (IWC, 1980) counted up to 29 GLGs in both the dentine and cementum in the killer whale teeth examined. Mitchell and Baker (1980), using a combination of dentinal and cemental GLGs, reported 35 GLGs in a reputedly very old male, known to locals of Twofold Bay, Australia, as 'Old Tom'. Christensen (1982; 1984) counted a maximum of 34 and 32 dentinal GLGs in a sample of 68 females and 53 males respectively collected off Norway.

The discrepancy between our age estimates and those based on dental laminations can probably be attributed to the poor definition of GLGs in older specimens. IWC (1980) concluded that killer whale age estimates based on dentinal layers were both inaccurate and imprecise. Myrick *et al.* (1988) examined labelled killer whale teeth with known histories and concluded that dentinal GLGs beyond about 20 years of age were too poorly defined to count and that cementum deposits were too thin to count.

Our estimates of the longevity of killer whales were of the same magnitude as the theoretical longevity of 72-81 years predicted for killer whales from intra-specific allometric relationships (Sacher, 1980). The longevity of killer whales was also comparable to that of pilot whales (*Globicephala* spp.). Based on cemental GLGs, Kasuya and Marsh (1984) found maximum ages of 63 and 46 years respectively for female and male short-finned pilot whales (*G. macrorhynchus*) taken off Japan. Similarly, maximum ages of up to 56.5 and 35.5 years were reported for female and male long-finned pilot whales (*G. melas*) taken off Newfoundland (Kasuya, Sergeant and Tanaka, 1988).

3.2 Calving and mating seasons

Information on the seasonality of calving in the study area was compiled from three sources: (1) observed births; (2) neonate strandings; and (3) the appearance of newborn calves between consecutive encounters.

We have never witnessed an animal giving birth in the wild. However, Jacobsen (1980), studying the northern community, observed the birth of a calf on 20 September 1980. Emery (1960) also gave an account of the birth of a set of twins in March 1949, off eastern Vancouver Island. In addition, a new born calf measuring 257cm was taken in the live-capture fishery in February 1967 (Wolman, National Marine Mammal Laboratory, Seattle, Wash., pers. comm.) and another calf was born in February to a female being held during the live-capture fishery (Newby, formerly University of Washington, Seattle, Wash., pers. comm.).

The timing of neonate strandings also provided information on the seasonality of calving. Carl (1946) reported a stranded calf found on 28 September 1944. In addition, eight stranded calves were recovered from the study area during 1973-87 (Table 5). Six of these, measuring 218 to 250cm in length, had umbilical stubs indicating they were neonates. Since the remaining three calves fell within the same length range, they were also considered neonates.

The dates of birth of the majority of calves born during the study were not known other than they were born sometime between summer field seasons. In some cases, however, newborn calves appeared between closely spaced consecutive encounters and the interval over which it was born could be delineated. The exact month of birth was established for four calves and the birth of eight others

Table 5

Information on neonate strandings recovered in the study area.

Date	Location	Form	Sex	Lcm	Condn	Umb.	Breathed	Source
28.09.44	Cherry Pt		F	246	fresh		stillborn?	1
	Lasqueti I.	T	M	244	fresh		stillborn?	2
09.05.76	Long Bch	R	M	250	fresh	yes		2
05.11.76	Radar Bch		M	226	fresh	yes		2
31.03.78	Oyster Bay		M	225	1-2 mo		yes	2
04.10.78	Victoria		M	221	3 wks	yes		3
15.11.83	Seattle		F	218	fresh	yes	yes	4
07.10.86	Tsawassen	R	M	226	fresh	yes	yes	2
13.11.87	Ucluelet	R	M	245	fresh	yes	yes	2

Key: T=Transient; R=Resident; L=Length; Condn=Condition; Umb.=Umbilicus; Y=yes. Sources: - 1=Carl, 1946; 2=Pacific Biological Station; 3=R. Baird pers. comm.; 4=T. Gornall pers. comm.

could be assigned to one of several months. The latter births were amortized over the interval in question. For example, a calf that was born between 1 December and 15 January was tallied as 0.67 births in December and 0.33 births in January.

Each source of data indicated that calving was diffusely seasonal with most births occurring between fall and spring (Fig. 6). The bimodal appearance of the frequency distribution was probably an artifact: the paucity of mid-winter births was attributable to a reduced sampling effort and the relative frequency of the study births during the study in fall months was undoubtedly exaggerated as this represented the end of the field season.

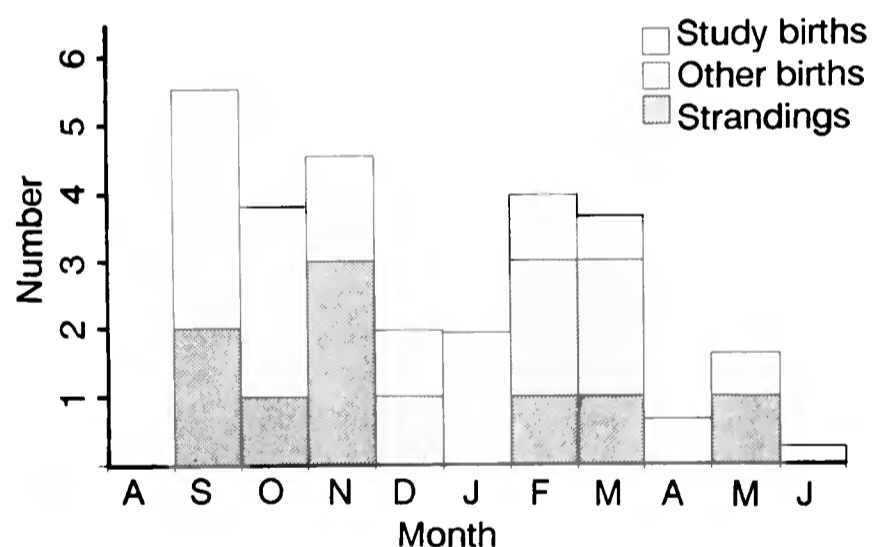

Fig. 6. Seasonality of calving in the study area. Data sources were: (1) the appearance of neonates between consecutive encounters during the study; (2) other observations of births; and (3) the timing of neonate strandings (see Section 3.2).

Using all three sources of data, the mean birth date was calculated as 16 December. In view of the aforementioned biases, the birth dates based on the appearance of calves between encounters were excluded and the mean birth date recalculated as 1 January. We considered the latter mean date more accurate and defined the calving season as the six months centered on this date, namely October-March. This period accounted for 70% of all births shown in Fig. 6. Assuming that the gestation period was 514.5 days (Walker, Cornell, Dahl, Czekala, Dargen, Joseph, Hsueh and Lasley, 1988), we estimated that mating occurred in May-October, with a mean date of conception in late-July or early-August.

Additional observations also suggested a winter calving season. Pike and MacAskie (1969) noted that very small calves were most prevalent in waters off British Columbia in winter and early spring, which they took to indicate a winter peak in parturition. A neonate with attached umbilicus stranded in Astoria, Oregon on 9 March 1987 (D. Duffield, Portland State University, Oregon, pers. comm.) and a 1-2 month old calf (260cm in length with most teeth erupted) was found stranded in California on 21 April 1985 (Heyning, 1988). Lengths of fetuses collected off Japan indicated a peak in mating during May-July and a probable gestation period of 16 months (Nishiwaki and Handa, 1958), which implied a September-November calving season. The available data therefore suggested that the reproductive cycle was synchronized throughout the North Pacific.

It is unclear to what extent the reproductive cycle varies in other regions. Term-size fetuses were prevalent in the Antarctic catches taken in January-March (Anderson, 1982), which suggested a peak in parturition in about January-April (i.e. late austral summer). The bimodal length frequency of the Antarctic fetuses also indicated a gestation period of greater than 12 months. The Norwegian data were ambiguous (see also Anderson, 1982). Based on foetal lengths, Christensen (1982; 1984) calculated that conceptions peaked during September-January, but was unable to ascertain the gestation period. Applying a gestation period of 514.5 days (Walker *et al.*, 1988) to the Norwegian data suggests a February-June calving season, but the few term-sized fetuses collected were taken in August-November. The seasonality of calf sightings in British and Irish waters suggested calves were born mainly between November-February (Evans, 1988).

3.3 Age at maturity

3.3.1 Females

In the cetacean literature, female age at maturity has been variously measured as the age at first ovulation, age at first pregnancy or the age at first parturition. We defined sexual maturity as the age at which females gave birth to their first viable calf (i.e. calves that survived to at least 0.5 years of age). The analysis was restricted to viable calves because many neonates likely died prior to age 0.5 years before being identified (Section 3.6.2). Moreover, since the age of the first viable birth represented the age at which females first contributed to recruitment, this was the most pertinent parameter in the population model.

Age at first birth was established based on the ages at which known-aged females gave birth to their first viable calves. In a few cases where the ages of females were only known to within ± 1 year, data were amortized over the two-year period. For example, a female born during either the 1972 or 1973 calving seasons was tallied as half a 14 and half a 15 year old during the 1987 calving season.

Fourteen known-aged females gave birth to their first viable calves during the study. Of the 24 known-aged females monitored to 11 years of age, none had given birth. Conversely, 4 of 5 females monitored to 16 years of age, the maximum age attained by known-aged females, had given birth. Thus, females typically gave birth to their first viable calf between 12 and 16 years of age.

DeMaster (1984) reviewed various procedures for estimating the mean age at maturity. The simplest method was to calculate the mean of the ages at which females matured. The mean of the ages at which the six known-aged females in cropped pods first gave birth was

Table 6

Rate and mean of maturation (i.e. birth of first viable calf) of known-aged females in cropped and uncropped pods combined. Computations and notation follow DeMaster (1978).

x	$n_{(x)}$	$y_{(x)}$	$z_{(x)}$	$r_{(x)}$	$x r_{(x)}$
10	25.0	0	0	0	0
11	24.0	0	0	0	0
12	24.0	3.0	0.125	0.125	1.500
13	19.0	4.0	0.211	0.086	1.118
14	15.0	6.0	0.400	0.189	2.646
15	11.5	7.5	0.652	0.252	3.780
16	5.0	4.0	0.800	0.148	2.368
17	-	-	0.900 ¹	0.100	1.700
18	-	-	1.000 ¹	0.100	1.800

\bar{X} mean age at first birth [$\sum x r_{(x)}$] = 14.91

x age

$n_{(x)}$ total number of known-aged females

$y_{(x)}$ number of females that had given birth to viable calves

$z_{(x)}$ proportion of females mature at age x [$y_{(x)}/n_{(x)}$]

$r_{(x)}$ proportion of females maturing at age x [$z_{(x)} - z_{(x-1)}$]

¹ Assumed that one known-aged female (G29) that had not given birth at age 16.5-17.5 years would give birth at age 17.5-18.5 years.

14.33 years (SE=0.432) and the mean for the eight females in uncropped pods was 13.19 years (SE=0.357). The means were not significantly different ($t=2.043$; $P=0.076$) so data were pooled for subsequent analyses. Although these means provided a valid comparison between cropped and uncropped pods, they tended to underestimate the true mean age at first birth. This bias was due to the decline in the sample-size of known-aged females with age (Table 6), such that females that matured at an early age were more likely to have matured during the study than those that matured at an older age.

The age by which 50% of the females were mature has often been reported as the mean age at maturity. In fact, this represents the median age at maturity and coincides with the mean only when the maturation curve is symmetric. The median age of first birth was interpolated as 14.40 years (14.64 and 13.77 years in cropped and uncropped pods; Fig. 7). Kasuya's (in DeMaster, 1984) small sample summation method gave similar values: 14.43 years overall (14.51 and 14.03 years in cropped and uncropped pods). Since the medians were based on the proportion of females mature at a given age, they were not subject to the aforementioned sample biases.

The bias introduced by diminishing sample sizes with age can be avoided by using DeMaster's (1978) method to estimate mean age at maturity. We should note that that method was more appropriate in the present case than DeMaster's (1981) method specifically designed to estimate the mean age at first birth. This was because we knew the complete calving histories of all known-aged females, which in essence satisfied DeMaster's (1978) assumption that 'animals that have not ovulated at age x have not ovulated before age x...[and]... animals that have ovulated at age x will ovulate every year thereafter'.

Since DeMaster's (1978) method required that the sample span the entire indeterminate period, we had to assume that the one known-aged female (G29) that had not given birth by age 16.5-17.5 years would have done so in the following year.¹ Although this tended to underestimate

¹ Data collected subsequently indicated that G29 did give birth in the following year, 1988.

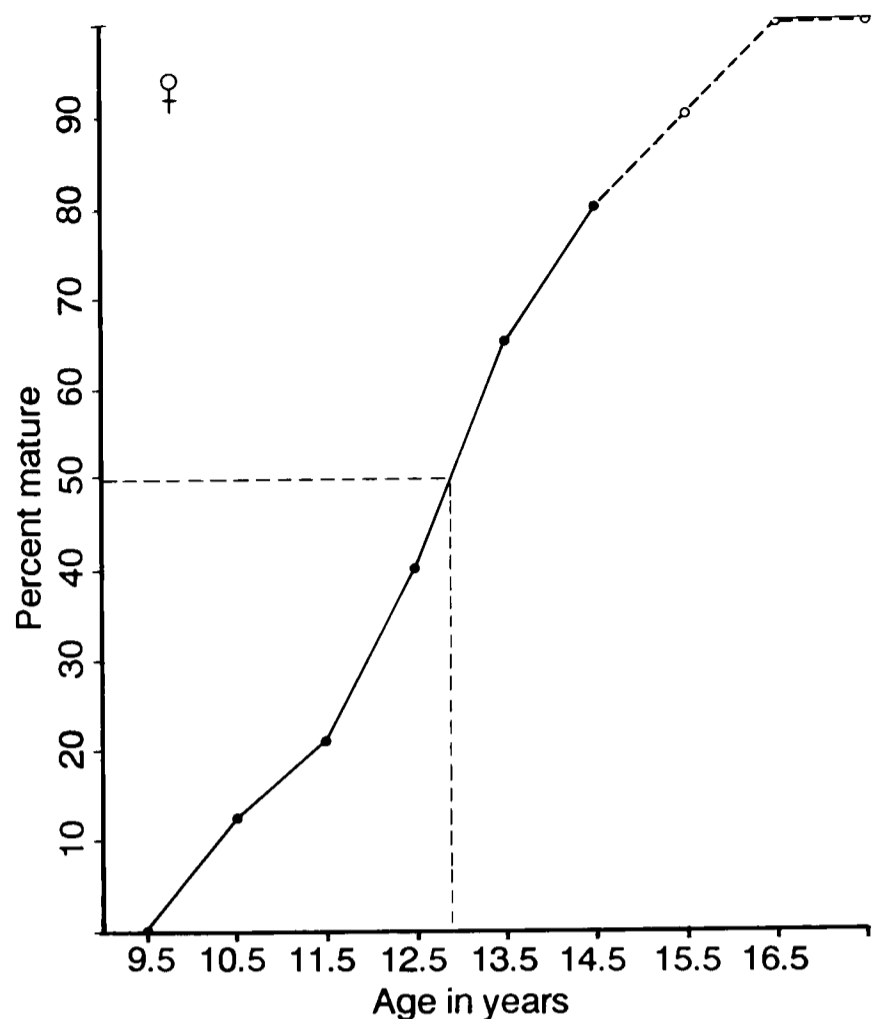

Fig. 7. Rate of maturation ($MAT_{f(x)}$) of known-aged females in cropped and uncropped pods combined based on age at birth of the first viable calf. Note that the data are plotted at the pivotal ages at which calves were considered viable.

the true mean, the bias increased by only 0.2 years for each additional year the animal remained barren. The overall mean age at first birth was calculated as 14.91 years (Table 6). The mean ages at first birth were similar in cropped and uncropped pods, 15.00 and 14.57 years respectively, but could not be formally compared due to the interdependence of the observations (i.e. the status of the same individual over several years was used in the analysis). These estimates were considered the most accurate indicator of mean age at first birth.

Assuming that the gestation period was 514.5 days (Walker *et al.*, 1988), we estimated that the first viable calf was conceived at 10.6–16.6 (mean=13.5) years of age. However, because neonate mortality was high (Section 3.6.2), the first conception may have occurred at a somewhat younger age. For example, if we assume that mortality in the first six months was 43% for all calves (Section 3.6.2) and the calving interval at 15 years of age was 4.3 years (equation (24)), the mean age at first birth of a calf, viable or non-viable, would be 13.1 years, and the mean age of conception 11.7 years. Considering that pubescent females may ovulate several times before conceiving (IWC, 1982), females may ovulate at an even earlier age.

Collections in the Antarctic indicate that females first became pregnant at about 16ft (4.9m) in length (IWC, 1982). Similarly, Christensen (1982; 1984) found that females off Norway first became pregnant at 15–16ft (4.6–4.9m) in length and suggested that this corresponded to 6–8 years of age. However, no data corroborating age and reproductive condition were provided. Christensen's (1982; 1984) growth curves indicated that females measuring 15–16ft in length actually ranged in age from 5 to 22 years (mean=15.0 years).

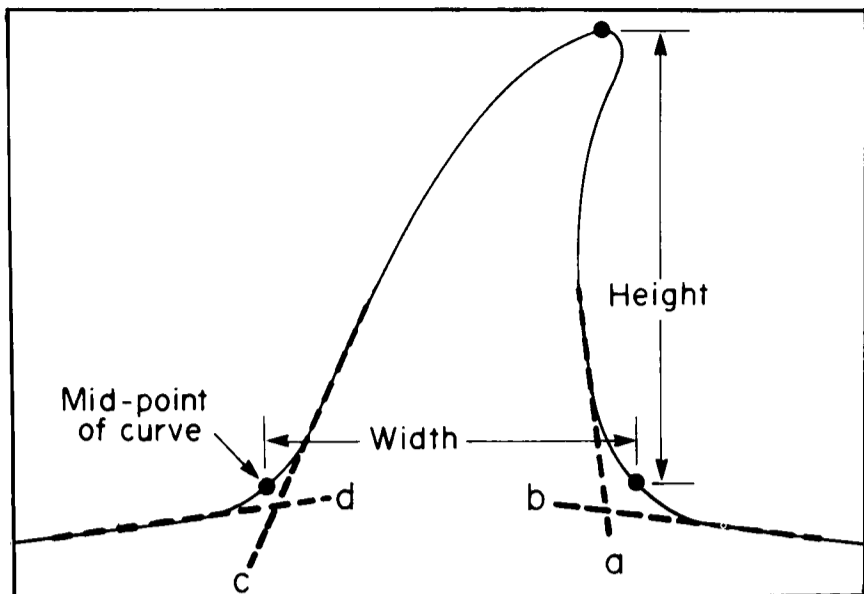

Fig. 8. Schematic of killer whale dorsal fin showing measurements used to derive height to width ratios (HWRs).

Age of maturation of female killer whales was slightly greater than in short-finned pilot whales (*G. macrorhynchus*), which first ovulate at 7–12 years of age (Kasuya and Marsh, 1984). Long-finned pilot whales (*G. melas*) first conceive at about 6–7 years of age (Sergeant, 1962; Kasuya, Sergeant and Tanaka, 1988).

3.3.2 Males

Mature male killer whales can be distinguished from mature females and juveniles by their tall dorsal fins. The adult male dorsal fin attains a height of about 1.5m compared to 0.9m in females (Bigg, 1982). The age at maturity of males was assessed based on the height to width ratio (HWR) of this secondary sexual characteristic (Fig. 8).

Fig. 9 shows the pattern of growth of the dorsal fin HWR for eight known-aged animals of each sex. Representative HWRs for each individual in a particular year were obtained by averaging 5–10 measurements (Fig. 8) from photographs in which parallax error appeared to be minimal.

The growth of the female dorsal fin was asymptotic with age, X , and could be described by a von Bertalanffy curve:

$$\text{HWR} = A \cdot \{1 - 1/3 e^{(-K \cdot [X-I])}\}^3 \quad (14)$$

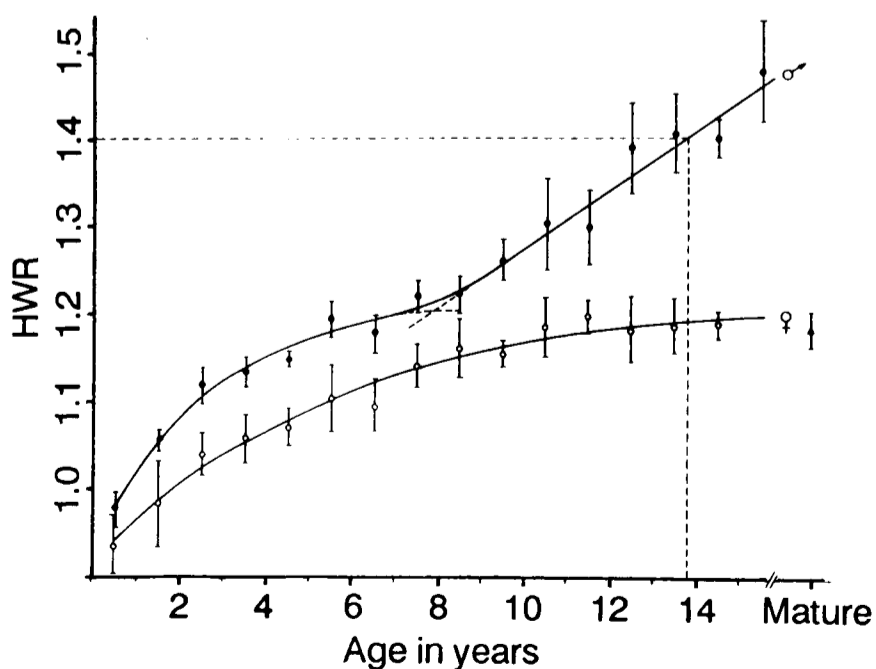

Fig. 9. Mean (\pm SE) dorsal fin height to width ratios (HWR) as a function of age for 8 known-aged animals of each sex: females (bottom) and males (top). The trend lines represent a linear regression and von Bertalanffy curve, both fitted by least squares criterion. The triangle represents the mean (\pm SE) for 15 older reproductive and post-reproductive females.

with an asymptote, A , of 1.219 ($\text{SE}=0.007$), K of 0.182 ($\text{SE}=0.008$) and I of -7.658 ($\text{SE}=0.269$). The mean HWR for 15 older reproductive and post-reproductive females ranged from 1.11–1.34 with a mean of 1.182 ($\text{SE}=0.019$), which was not significantly different ($P>0.10$) from the asymptote of the von Bertalanffy curve. Thus, growth of the female dorsal fin ceased or became isometric at about 10 years of age. The HWR of females never exceeded 1.40.

The growth of the male dorsal fin followed a different pattern (Fig. 9). The increase in HWR with age was initially rapid but slowed by about 4–7 years of age. Growth during this phase could be described by a von Bertalanffy curve with $A=1.157$ ($\text{SE}=0.012$), $K=0.760$ ($\text{SE}=0.160$) and $I=-2.346$ ($\text{SE}=0.466$). However, between 8 and 15 years of age, HWR increased linearly with age, X :

$$\text{HWR} = 1.014 + 0.027 \cdot X \quad (P<0.001, r^2=0.95) \quad (15)$$

By 10.5 to 17.5 years of age, the HWR surpassed 1.40, at which point males could be readily distinguished from juveniles and adult females. We thus defined the year in which the HWR attained a value of 1.40 as the onset of sexual maturity. Being a secondary sexual characteristic, the development of the dorsal fin probably coincided with the onset of spermatogenesis. However, since the male dorsal fin actually began to develop 2–3 years prior to becoming distinguishable from female and juvenile fins, some sperm production probably occurred several years prior to that which we defined as the onset of sexual maturity.

After attaining an HWR of 1.40, growth of the male dorsal fin continued but was asymptotic (Fig. 10) and conformed to a von Bertalanffy curve with $A=1.743$ ($\text{SE}=0.030$), $K=0.318$ ($\text{SE}=0.051$) and $I=-4.728$ ($\text{SE}=0.671$). The mean HWR of ten randomly selected older males exhibiting stable HWRs ranged from 1.63 to 1.83 with a mean of 1.72 ($\text{SE}=0.023$), which was not significantly different from the asymptote of the growth curve ($P>0.50$). Thus, by about six years following the onset of sexual maturity (HWR=1.40) the increase in the dorsal fin HWR was 90% complete and was not discernible from that of older males. At that point, males were referred to as physically mature.

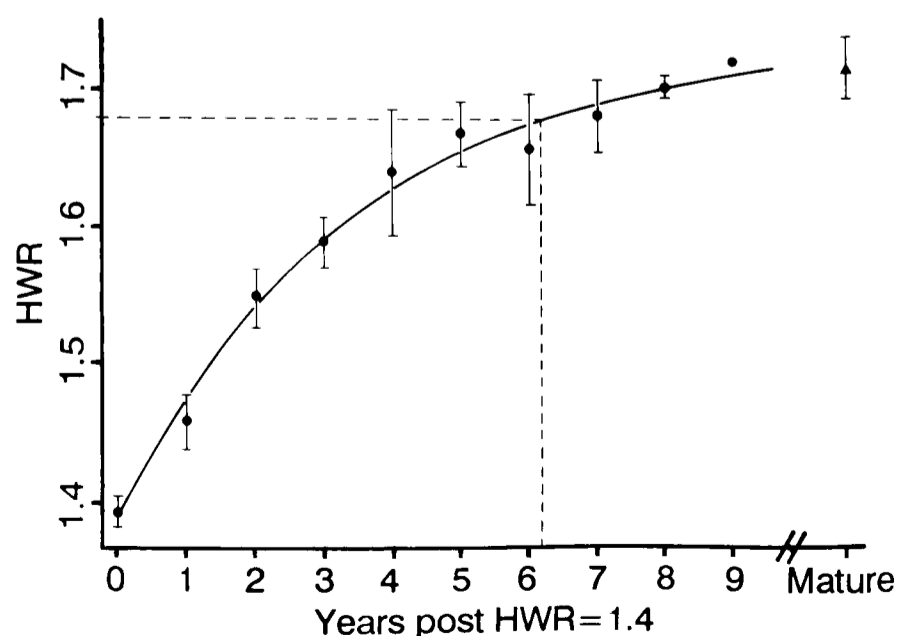

Fig. 10. Mean (\pm SE) dorsal fin height to width ratios (HWR) as a function of the number of years following the onset of sexual maturity (i.e. the first year the HWR attained 1.40). The triangle represents the mean (\pm SE) for 10 older physically mature males.

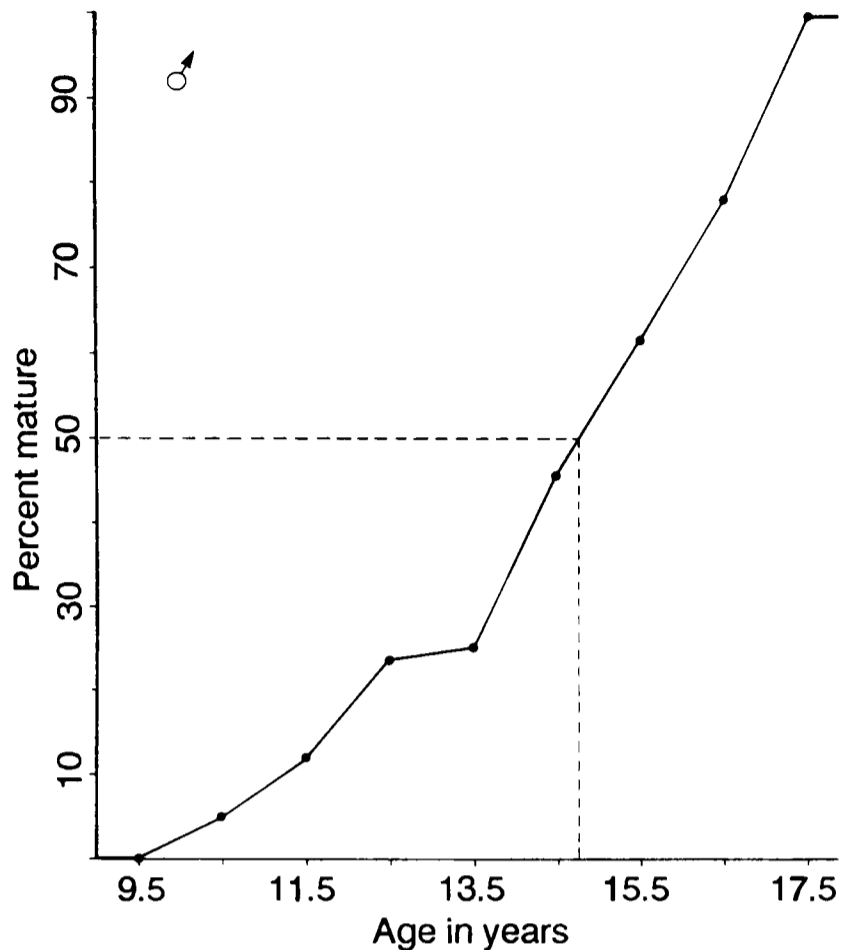

Fig. 11. Rate of maturation ($MAT_{m(x)}$) of known-aged males in cropped and uncropped pods combined based on the first year that the HWR attained 1.40.

The mean and median ages at sexual maturity of males were calculated in the same manner as the age at first birth of females (Section 3.3.1). Because only one known-aged male matured (at age 14.5 years) in cropped pods, data for cropped and uncropped pods were pooled. Known-aged males attained sexual maturity between 10.5 and 17.5 years of age and 50% had matured by 14.78 years of age (Fig. 11). A nearly identical value, 14.62 years, was obtained using Kasuya's (DeMaster, 1978) small sample procedure. Using DeMaster's (1978) method, the mean age at onset of sexual maturity was estimated at 15.00 years (Table 7). Since the dorsal fin continued to develop for an additional 6 years, the mean age at physical maturity was estimated at 21.00 years.

Jonggård and Lyshoel (1970) examined the testes of three killer whales taken off Norway and suggested that spermatogenesis first occurred at about 19ft (5.8m) in length. Based on changes in testes weight, Mikhalev, Ivashin, Savusin and Zelenya (1981) reported that males taken in the Southern Hemisphere matured at 21ft (6.4m)

Table 7

Rate and mean of age of maturation (i.e. first year $HWR \geq 1.40$ of known-aged males in cropped and uncropped pods combined. Calculations and notation as per Table 6.

x	$n_{(x)}$	$y_{(x)}$	$z_{(x)}$	$r_{(x)}$	$x \cdot r_{(x)}$
9.5	23.0	0	0	0	0
10.5	21.0	1.0	0.048	0.048	0.504
11.5	17.0	2.0	0.118	0.070	0.805
12.5	17.0	4.0	0.235	0.117	1.463
13.5	14.0	3.5	0.250	0.015	0.203
14.5	11.0	5.0	0.455	0.205	2.973
15.5	6.5	4.0	0.615	0.160	2.480
16.5	4.5	3.5	0.778	0.163	2.690
17.5	0.5	0.5	1.000	0.222	3.885
					$\bar{X}=15.00$

in length whereas Bigg (1982), noting that the sharpest increase in testis weight occurred between 18 (5.5m) and 19–20ft (5.8–6.1m), interpreted the data as indicating maturity at 19–20ft. According to Christensen's (1982, 1984) growth curve, males measuring 19–20ft were generally aged 15–18 years (mean=19.8 years; range 13–32 years).

In comparison, Kasuya and Marsh (1984) found that the testes of short-finned pilot whales (*G. macrorhynchus*) were typically functional by 15.8 years of age. However, they also noted that testis weight continued to increase to about 25 years of age and thus postulated that males attained social maturity many years after functional maturity.

3.4 Gross reproductive rates

Reproductive terminology has not been used consistently in the literature. We defined the fecundity rate as the proportion of mature females that gave birth to viable calves each year; the fertility rate as proportion of mature females that gave birth to either viable or non-viable calves each year; and the pregnancy rate as the proportion of mature females pregnant at a specified time. We focused on fecundity, as it represented the net contribution to recruitment and was therefore the most pertinent parameter in the population model.

3.4.1 Multiplets

A total of 134 calves were born during the study. Except for two sets of twins (one in both cropped and uncropped pods), females gave birth to single calves. This represented a twinning frequency of 1.5% (SE=1.06%). In the first set, one died between 1.5 and 2.5 years of age whereas its sibling was still alive when last seen at age 3.5 in 1987; and in the second set, both were still alive when last seen at age 7.5 years in 1987. Emery (1960) also described the birth of a set of twins in a shallow lagoon off eastern Vancouver Island in 1949.

These observations apparently represent the first of viable multiplets in cetaceans (IWC, 1984). *In utero* multiplet frequencies ranging from 0.57% to 2.3% have been reported in baleen whales, but it was assumed that mature delivery of these would have been unlikely (IWC, 1984). Gambell (1972) reported *in utero* twinning frequencies of about 0.5% in sperm whales. Multiplets have not been observed in long-term field studies of *Tursiops* or *Stenella* (Scott and Wells in IWC, 1984). Similarly, Kasuya and Marsh (1984) reported single foetuses in all of the 141 short-finned pilot whale (*G. macrorhynchus*) pregnancies examined. The twinning frequency in killer whales was similar to the 1–2% average reported for humans (Benirschke in IWC, 1984).

3.4.2 Calving intervals

The interval between successive births provided one measure of the rate of calf production. The intervals between 77 viable births (28 in cropped and 49 in uncropped pods) were established. These included the intervals between all viable calves born during the study as well as several intervals between calves born 1–2 years prior to the start of the study and calves born early in the study. The latter intervals were included because the gestation period was 514.5 days (Walker *et al.* 1988), so that females could not have given birth to viable calves that died in the intervening years.

Calving intervals ranged from 2–12 (mean=5.86) years in cropped pods and 2–10 (mean=5.02) years in uncropped pods (Fig. 12). The difference between the means was marginally significant (ANOVA; $F=2.87$, $P=0.095$) and was largely attributable to the two 12-year intervals in the cropped pods. Data were therefore pooled giving an overall mean calving interval of 5.32 years ($SE=0.241$). When the two 0-year intervals are included to account for the two sets of twins, the mean calving interval was 5.19 years ($SE=0.253$).

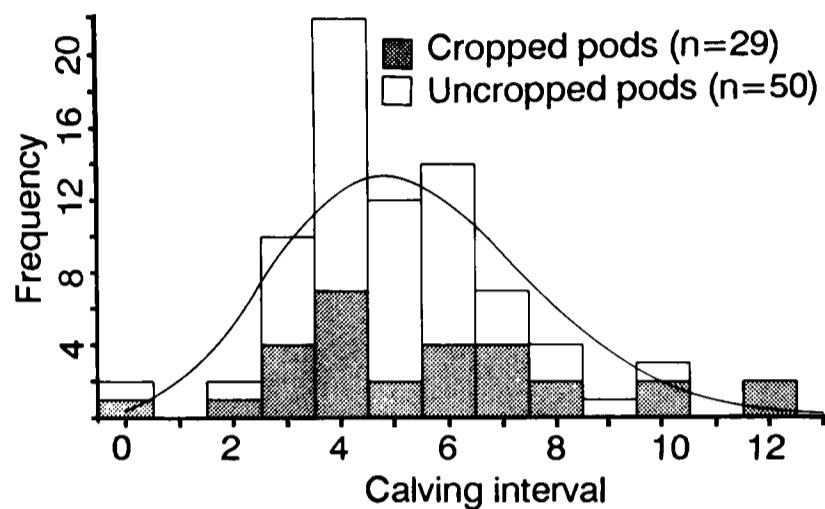

Fig. 12. Frequency distribution of calving intervals recorded during the study. The two zero-intervals represent the birth of twins. The trend line represents a Poisson distribution.

The relative frequencies of the calving intervals followed a Poisson distribution (chi-squared=12.5; $P=0.160$), which implied that females gave birth at random intervals rather than conforming to a fixed calving schedule.

3.4.3 Fecundity rates

One measure of the fecundity rate of females that calved during the study, FEC_c is:

$$FEC_c' = CI^{-1} \quad (16)$$

where CI represents the mean calving interval (including the 0-year intervals for twins). This gave fecundity rates of 0.177 and 0.203 for cropped and uncropped pods respectively and an overall fecundity rate of 0.193. However, FEC_c' underestimates the true fecundity of reproductive females. Females are defined as being reproductive between the birth of their first and last calves. The bias in FEC_c' arises because, by definition, females give birth in both the first and last year of their reproductive lifespan (RL) such that the number of calves born is one greater than the number of calving intervals. Thus, an unbiased estimate of FEC_c is:

$$FEC_c = (RL \cdot CI^{-1} + 1) / RL \quad (17)$$

For an RL value of 25.5 years (Section 3.4.4), FEC_c was estimated at 0.216 in cropped pods, 0.242 in uncropped pods and 0.232 overall.

Alternatively, the fecundity rate of all mature females, FEC_t , is given by:

$$FEC_t = \frac{\sum_{i=1}^n NC_i}{\sum_{i=1}^n NY_i} \quad (18)$$

where NC_i is the total number of calves born to the i th mature female during the study, NY_i the total number of years the i th mature female was monitored and n the total number of mature females in the population. Mature females are defined as those that had given birth to viable calves. The variance of FEC_t is:

$$\text{Var}(FEC_t) = FEC_t (1 - FEC_t) \sum_{i=1}^n NY_i^{-1} \quad (19)$$

The 46 mature females in cropped pods were monitored for a combined total of 520 years (mean=11.3 years) during which they gave birth to 50 viable calves. This represents a fecundity rate of 0.096 ($SE=0.0129$). The 56 mature females in uncropped pods were monitored for a combined total of 544 years (mean=9.7 years) during which they were known to have given birth to 84 viable calves. An additional 1.2 viable calves in uncropped pods were estimated to have died prior to being identified (Section 3.6.3). This represents a fecundity rate of 0.157 ($SE=0.0155$). Fecundity rates in cropped and uncropped pods were significantly different ($P<0.01$). Also, both were considered significantly lower than their respective FEC_c s. Although FEC_t and FEC_c could not be formally compared, the FEC_t values were significantly lower than the respective FEC_c' values ($P<0.01$), and the latter were lower than the corresponding FEC_c s.

The disparity between FEC_c and FEC_t resulted because not all mature females were equally productive. Indeed, there were a number of mature females in both cropped and uncropped pods that did not give birth during the study and others that gave birth to their last calf early in the study. We attribute this to reproductive senescence. With one exception (K40 – a female that had not given birth by 20.5–24.5 years of age), all of the young mature females were productive (Section 3.5.3). Conversely, the unproductive females tended to be the oldest females and all had older progeny, indicating that they had been productive in the past.

The fecundity rates of reproductive females, FEC_r , were calculated using equation (18) by excluding all post-reproductive females. Post-reproductive females were classified as mature females that had not given birth for at least 10 years. This gave FEC_r s of 0.198 ($SE=0.0251$) and 0.224 ($SE=0.0215$) for cropped and uncropped pods, respectively. These values were not significantly different ($P>0.50$), so data were pooled giving an overall FEC_r of 0.214 ($SE=0.0164$). The FEC_r s were similar and not significantly different ($P>0.30$) than the corresponding FEC_c s. The FEC_c values were about 8–10% greater than the FEC_r s, as the former tended to overestimate fecundity because shorter calving intervals were more likely to have been completed during the study than longer calving intervals. We therefore consider the overall FEC_r of 0.214 as the most accurate measure of the fecundity rate of reproductive females.

The disparity of the FEC_t s between cropped and uncropped pods could be attributed to differences in the ratios of reproductive to post-reproductive females. In uncropped pods, a weighted mean of 66.1% of mature females were reproductive – remarkably close to the 66.9% expected in a stable population (Section 4.2.6). In contrast, only 45.7% of the mature females in cropped pods were reproductive. This anomaly is discussed in Section 4.3.3. Based on the overall FEC_r of 0.214, and assuming that 66.9% of mature females were reproductive, the FEC_t for a stable population was estimated at 0.143, which does not differ significantly from the observed value of 0.154 in uncropped pods ($P>0.40$).

3.4.4 Reproductive lifespan

The reproductive lifespan is defined as the span between the onset of sexual maturity and onset of reproductive senescence (i.e. the interval between the birth of the first and last viable calf). This parameter could not be estimated directly because a number of females that gave birth prior

to the start of the study were still reproductive at the end of the study, which indicated that the reproductive lifespan exceeded the 15 year duration of our study.

The youngest female that gave birth was 12.0 years of age and the oldest was estimated to have been 41.7 years of age (several females greater than 40 years of age gave birth). This implies that the reproductive lifespan spanned up to 30 years. The maximum number of calves presumed to have been born to females provided another measure of the length of the reproductive lifespan. Nine females had five offspring and one had six (Bigg *et al.*, 1990). Given a mean calving interval of 5.32 years (Section 3.4.2), this suggests that the reproductive lifespan is on the order of 21–27 years.

An estimate of the mean reproductive lifespan, RL, is given by:

$$RL = NC/FEC_r \quad (20)$$

where NC denotes the mean number of calves born to a female over her RL. NC cannot be directly estimated because RL exceeded the duration of our study. However, if it is assumed that the reproductive females in uncropped pods were randomly distributed at various stages of their RL, they would, on average, have given birth to about half their total progeny. NC can thus be estimated by doubling the mean number of offspring born to females, including those born prior to start of the study (Bigg *et al.*, 1990). Females in cropped pods were excluded from the analysis since they may have had progeny removed prior to the start of the study.

The 45 reproductive females in uncropped pods had a mean of 2.73 offspring, which gave an NC of 5.47. On the one hand, this is an underestimate because (1) some progeny may have died prior to the start of the study; and (2) the age-composition of females in an increasing population would be skewed toward younger females (Section 4.2.7). On the other hand, it is an overestimate because fecundity tended to decline with age such that more than half of progeny would be born by the midpoint of the reproductive lifespan (Section 3.5.2). Assuming these biases cancel, the mean RL is estimated to be 25.5 years.

A more precise estimate of RL is obtained and reproductive senescence discussed in greater detail in Section 3.5.3.

3.4.5 Fertility and pregnancy rates

Because some calves die at birth or shortly thereafter, fertility rates, FER, tend to be greater than fecundity rates, FEC:

$$FER = FEC / 1 - MR_n \quad (21)$$

depending on the magnitude of neonate mortality, MR_n . Neonate mortality is defined as that occurring before 0.5 years of age. Although precise estimates could not be obtained, the available data indicate that MR_n is of the order of 43% (Section 3.6.2). Substituting this value and the overall FEC_r estimate of 0.214 (Section 3.4.3) in equation (21), the fertility rate for reproductive females, FER_r , is 0.375. Similarly, the fertility rate of all mature females, FER_t , is 0.251.

Ignoring *in utero* mortality, the mean annual pregnancy rate, MAPR, is:

$$MAPR = FER \cdot G / 365.25 \quad (22)$$

where G is the gestation period measured in days. Walker *et al.* (1988) measured the average gestation period for two captive killer whales at 514.5 days (16.9 months). We

considered these direct measurements more reliable than the crude 12–16 month estimates based on foetal-length data (Christensen, 1982; 1984; Nishiwaki and Handa, 1958). This gives a $MAPR_r$ of 0.528 for reproductive females and a $MAPR_t$ of 0.354 for all mature females.

Due to the seasonality of calving, pregnancy rates fluctuate about the MAPR throughout the year. The proportion of females pregnant in month m, $MPR_{(m)}$, can be calculated as:

$$PR_{(m)} = MAPR \frac{\sum_{i=m}^{m+17} NB_i}{\sum_{i=m}^{m+12} NB_i} \quad (23)$$

where NB_i denotes the proportion of births that occurred in the *i*th month, with $NB_i = NB_{i-12}$ for $i > 12$. Note that the gestation period has been rounded to 17 months. Based on the NB_i s shown in Fig. 6 (excluding the study births had a negligible effect), the $MPR_{r(m)}$ for reproductive females varied from 0.409 at the end of the calving season in April to 0.614 just prior to the start of the calving season in September, which corresponds to $MPR_{t(m)}$ s for all mature females of 0.274 and 0.411 (Fig. 13). The April maximum and September minimum represent 77% and 116% of the MAPR, which indicates that monthly pregnancy rates can vary by a factor of 1.5 depending on season.

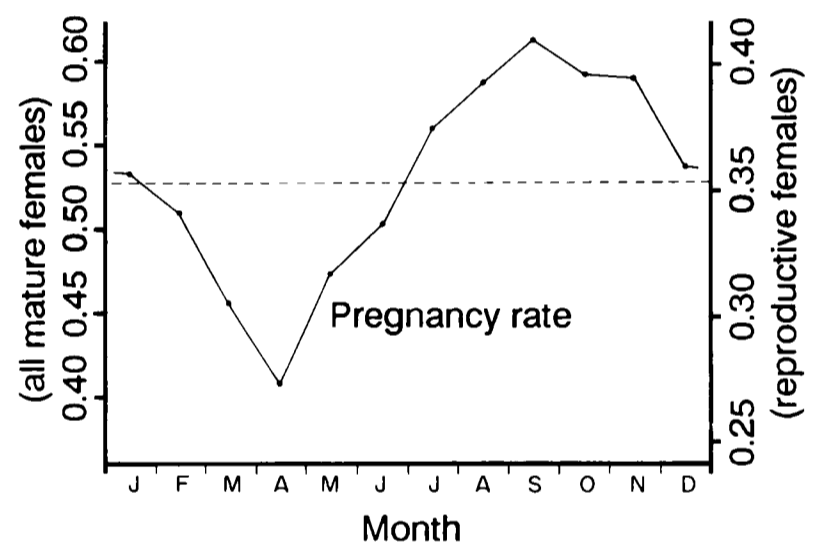

Fig. 13. Seasonal variation in the estimated monthly pregnancy rates ($MPR_{(m)}$) (solid line) and the mean annual pregnancy rate (MAPR) (dashed line) for reproductive females (right scale) and all mature females (left scale).

The estimated $MAPR_t$ of 0.354 falls within the broad range of published pregnancy rates for mature killer whales. Pregnancy rates of 0.275 were reported for mature females collected in the Southern Hemisphere mainly during December–March in 1961–79 (Mikhalev *et al.*, 1981) and 0.334 for mature females collected in the Antarctic during January–March in 1979/80 (Anderson, 1982). These rates represent 78% and 94% of our $MAPR_t$ or, perhaps more appropriately (Section 3.2), 67% and 81% of our pre-calving estimate of 0.411. Christensen (1984) reported that 0.432 of mature females of known status were pregnant based on an examination of ovaries collected off Norway from 1978–80 – 122% of our $MAPR_t$. In contrast, foetuses were reported in only 0.148 of the females measuring ≥ 16 ft (4.9m) collected annually off Norway from 1938–67 (Jonsgård and Lyshoel, 1970; modified from Bigg, 1982) – only 42% of our $MAPR_t$. However, the data given in Christensen's (1982) Appendix Tables indicated that 47% of foetuses had been overlooked by the Norwegian whalers.

Fertility rates (i.e. pregnancy rates adjusted for the gestation period) have been widely used as a measure of recruitment rates in cetacean population assessments. The

foregoing analysis indicates that, for killer whales, fertility rates grossly overestimates recruitment due to the high incidence of neonate mortality. Since there is some evidence that neonate mortality may also be appreciable in other species (Section 3.6.2), fertility rates may generally overestimate recruitment. Fortunately, the net bias introduced by neglecting neonate mortality may not be serious, because fecundity and juvenile survival rates are often estimated jointly by balancing the population. There would, however, be a tendency to overestimate fecundity and underestimate juvenile survivorship. For example, Kasuya and Marsh (1984) dismissed the high neonate mortality indicated by their data, but subsequently had to inflate juvenile mortality rates to balance the population. Moreover, if neonate mortality is compensatory density dependent changes in fecundity rates may not necessarily be reflected by changes in pregnancy rates.

3.5 Age-specific reproductive rates

3.5.1 Calving intervals

Age-specific changes in the fecundity of reproductive females should be reflected by variations in calving intervals with age. Fig. 14 shows the calving intervals, CI_i , derived in Section 3.4.2, plotted as a function of the estimated ages of mothers at the midpoint of the interval, $MAGE_i$. Despite the large degree of scatter, CIs tend to increase with $MAGE$ in both cropped and uncropped pods. The regressions were marginally significant for cropped pods ($r^2=0.118$; $P=0.073$) and highly significant for uncropped pods ($r^2=0.115$; $P=0.007$). Since the regressions were not significantly different ($P>0.50$), data were pooled giving an overall regression of:

$$CI_{(MAGE)} = 3.045 + 0.086 \cdot MAGE \quad (24)$$

$(r^2=0.077; P=0.014)$

Although the regression indicates that the fecundity rates declined with age, it accounts for only 7.7% of the total variation in calving intervals and is thus of little predictive value and does not indicate whether the relationship was in fact linear.

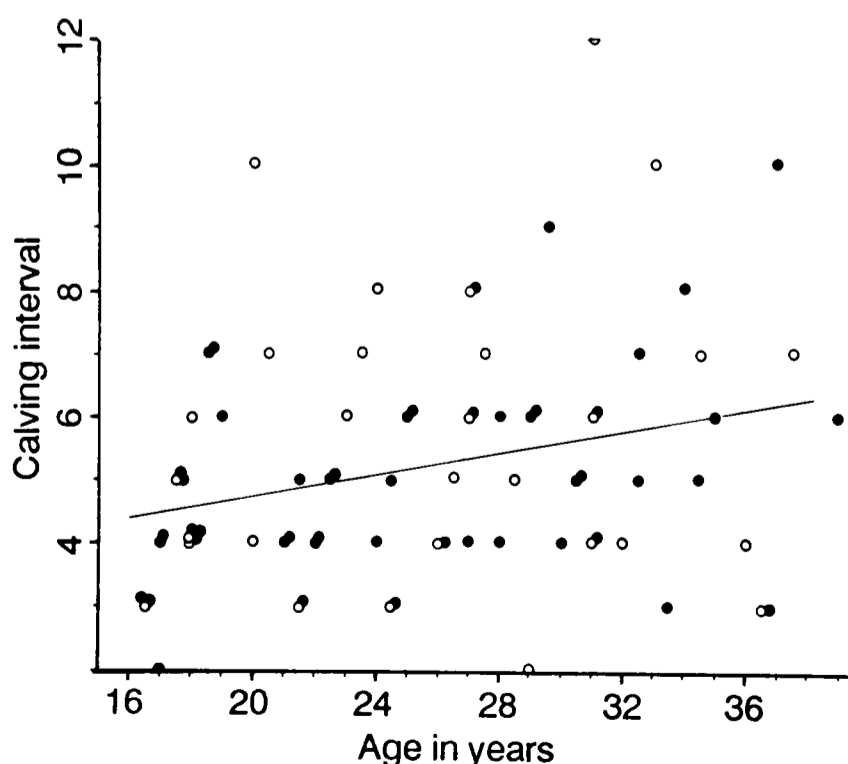

Fig. 14. Calving intervals (CI) in cropped (○) and uncropped (●) pods as a function of the estimated age of the mother at the midpoint of the calving interval (MAGE). The trend line represents a least squares linear regression fitted to pooled data.

3.5.2 Fecundity rates

Age-specific fecundity rates can be calculated analogous to equation (18) on a probabilistic age basis. The fecundity rate at age x , $FEC_{(x)}$, is:

$$FEC_{(x)} = \frac{\sum_{i=1}^n PC_{i(x)}}{\sum_{i=1}^n PY_{i(x)}} \quad (25)$$

where $PC_{i(x)}$ denotes the probability that the i th female was aged x in each of the years she calved during the study, $PY_{i(x)}$ the probability that the i th female was aged x in each year she was monitored and n the number of mature females. The probabilities of being a given age were obtained from the age probability density functions (2) and (4). The analysis was based on all mature females in uncropped pods and females in cropped pods that were not aged on the basis of the mean birth date of their calves or the birth date of their last calf. The other females in cropped pods were excluded because age-specific reproductive parameters had been used in the derivation of their ages. The calculated $FEC_{(x)}$ values in uncropped pods were multiplied by a correction factor of 1.014 to account for the estimated 1.2 viable calves that died prior to being seen (Section 3.6.3). As in Section 3.4.3, fecundity rates were calculated for both reproductive females, $FEC_{r(x)}$, and for all mature females, $FEC_{t(x)}$.

Changes in the fecundity of reproductive females, $FEC_{r(x)}$, with age are shown in Fig. 15. Since only mature females were included in the analysis, and mature females were defined as those that had given birth to viable calves, the $FEC_{r(x)}$ values between ages 12.5 and 19.5 years warrant comment. The fecundity rate of females aged 12.5 was 1.0, as this represents the earliest age at which females gave birth, such that all females classified as mature gave birth. Fecundity rates subsequently declined to age 17.5 years as the proportion of females that matured increased, but few had given birth to a second calf. In essence, this segment of the fecundity curve represents the reciprocal of the maturation curve (Fig. 7). The secondary peak at ages 18.5–19.5 represents females that were giving birth to their second calves. By 20.5 years of age, the above patterns were obscured.

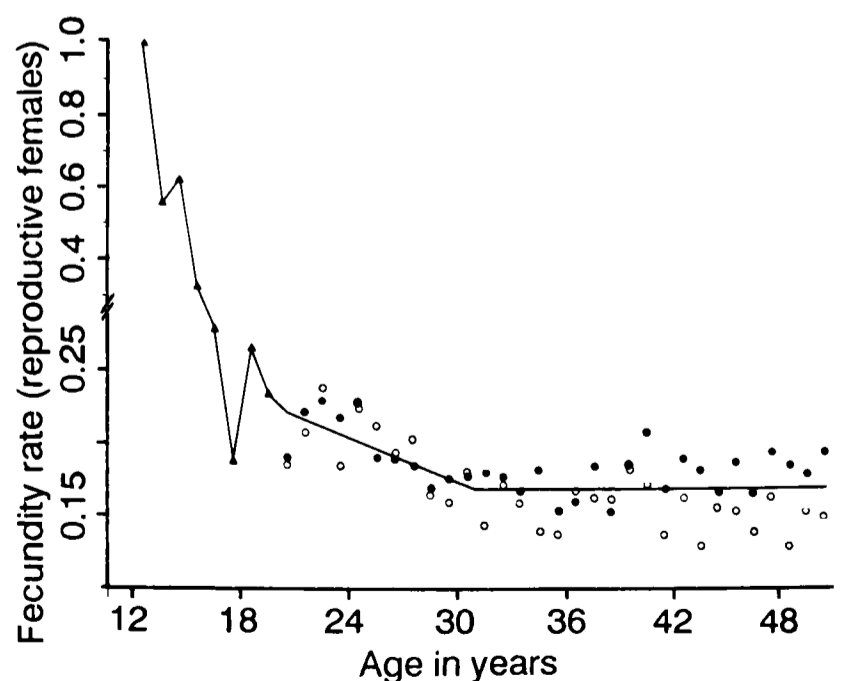

Fig. 15. Fecundity rates for reproductive females ($FEC_{r(x)}$) in both cropped (○) and uncropped (●) pods as a function of age. The trend lines represent a least squares regression fitted to pooled data for females aged 20.5–29.5 years and the mean weighted fecundity rate of females aged ≥ 30.5 years.

Beyond 20.5 years of age, $FEC_{r(x)}$ declined with age in both cropped ($P=0.049$) and uncropped pods ($P=0.011$), but the declines were non-linear (Fig. 15). A series of piecewise regressions (Neter and Wasserman, 1974), indicated that inflections occurred between 29.5 and 30.5 years of age. Separate regressions, with each datum weighted according to its total $PY_{(x)}$, were therefore fitted to ages 20.5 through 29.5 years and to ages greater than 29.5 years. The former regressions were significant for females in both cropped ($r^2=0.365$; $P=0.049$) and uncropped pods ($r^2=0.523$; $P=0.012$), but the regressions were not significantly different from each other ($P>0.40$). Data were therefore pooled, giving an overall regression of:

$$FEC_{r(x)} = 0.318 - 0.00487 \cdot X \quad \text{for } 20.5 \leq X \leq 29.5 \quad (26)$$

$(r^2=0.516; P=0.013)$

Beyond 30.5 years of age, there was no evidence of a further change in $FEC_{r(x)}$ with age in either cropped ($r^2=0.103$; $P=0.156$), or uncropped pods ($r^2=0.101$; $P=0.161$), or when data were pooled ($r^2=0.016$; $P=0.586$). Representative fecundity rates for females aged 30.5 years or greater were therefore calculated as the weighted mean $FEC_{r(x)}$. The means for cropped pods and uncropped pods were not significantly different ($F=0.307$; $P>0.50$), so data were pooled giving an overall weighted mean $FEC_{r(x)}$ of 0.162. It should be noted that the probabilities of reproductive females being aged greater than about 40 years were very small. Thus, the differences between the $FEC_{r(x)}$ of the oldest females in cropped and uncropped pods apparent in Fig. 15 were unimportant and had little effect in the ANOVA.

Age-specific fecundity rates for all mature females, $FEC_{t(x)}$, were calculated in the same manner (Fig. 16). For ages 12.5 through 19.5 years, $FEC_{r(x)}$ and $FEC_{t(x)}$ coincided because all of the mature females were reproductive. Beyond 20.5 years of age, $FEC_{(x)t}$ declined linearly with age for females in both cropped ($r^2=0.930$; $P<0.01$) and uncropped pods ($r^2=0.971$, $P<0.01$). The regressions were not significantly different ($P>0.50$), so data were pooled giving an overall regression of:

$$FEC_{t(x)} = 0.367 - 0.00714 \cdot X \quad \text{for } 20.5 \leq X \leq 60.5 \quad (27)$$

$(r^2=0.971, P<0.01)$

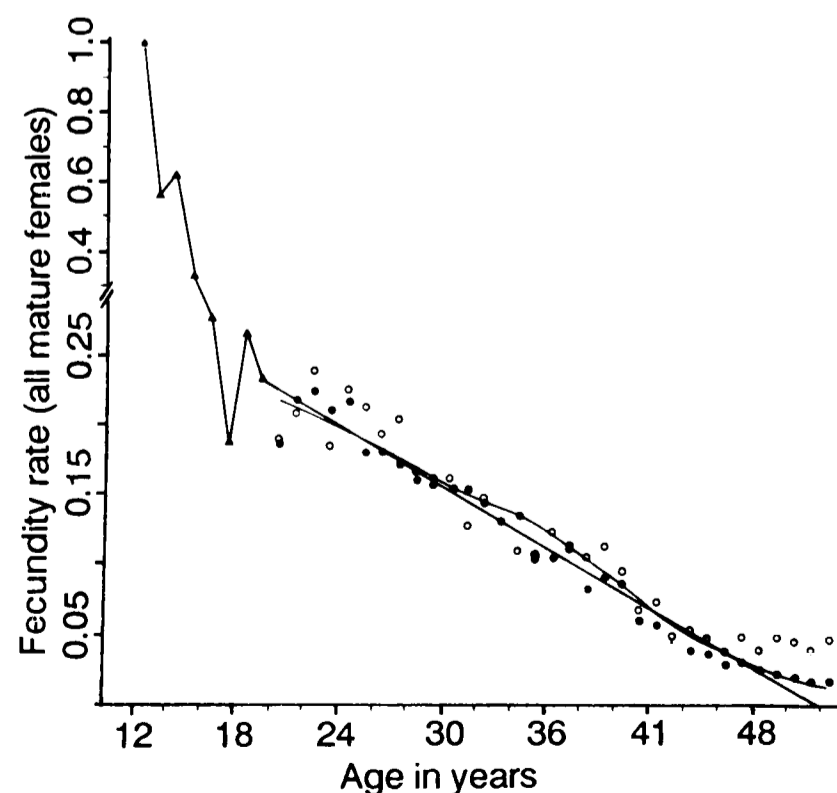

Fig. 16. Fecundity rates for all mature females ($FEC_{t(x)}$) in both cropped (○) and uncropped (●) pods as a function of age. The bold trend line represents a least squares linear regression fitted to pooled data and the thin trend line the product of $FEC_{r(x)}$ and $PR_{(x)}$.

3.5.3 Reproductive senescence and lifespan

As discussed in Section 3.4.3, there was evidence of reproductive senescence in older females. This explains why $FEC_{r(x)}$ remained constant beyond age 30.5 years whereas $FEC_{t(x)}$ declined linearly with age. Indeed, the ratio of these two parameters provides an estimate of the proportion of females that were post-reproductive at a given age, $PR'_{(x)}$:

$$PR'_{(x)} = 1 - (FEC_{t(x)}/FEC_{r(x)}) \quad (28)$$

where $FEC_{t(x)}$ and $FEC_{r(x)}$ represent the weighted mean of values for cropped and uncropped pods.

The $PR'_{(x)}$ estimates indicates that the rate of onset of reproductive senescence is symmetrical (Fig. 17) and can be described by a logistic equation:

$$PR_{(x)} = (e^{-K(X-I)} + 1)^{-1} \quad (29)$$

with rate, K , of 0.217 ($SE=0.006$) and inflection, I , of 40.098 ($SE=0.128$). The poor fit of the right tail of the logistic curve is probably an artifact of the recursive ageing method used, such that the age probability density functions had long right-hand tails. Since the vast majority of these older females were post-reproductive, the poor fit is of little consequence. For example, the cumulative difference between the $PR'_{(x)}$ s and $PR_{(x)}$ s for ages 48–62 years translates to a total of only 0.081 calves.



Fig. 17. Rate of onset of reproductive senescence ($PR_{(x)}$) of females in cropped and uncropped pods combined. The trend line represents a logistic equation fitted to pooled data using least squares criterion.

The estimated mean age of onset of post-reproduction is 40.1 years, which indicates that females typically gave birth to their last viable calf at 39.1 years of age. Given that the estimated mean age at first birth was 14.9 years (Table 6), the mean reproductive lifespan is 25.2 years – similar to the 25.5 years estimated in Section 3.4.4.

The mean cumulative number of viable calves produced by females at a given age can be calculated in two ways: (1) from the cumulative sum of the product of the $MAT_{f(x)}$, $FEC_{r(x)}$ and $PR_{(x)}$ shown in Figs 7, 15 and 17; and (2) from the cumulative sum of the product of the $MAT_{f(x)}$ and $FEC_{t(x)}$ shown in Figs 7 and 16. The two methods gave nearly identical results, never deviating from one another by more than 1.5%, and indicate that females that survived to the end of their reproductive lifespan produced an estimated 5.38 and 5.32 viable calves, respectively. In both

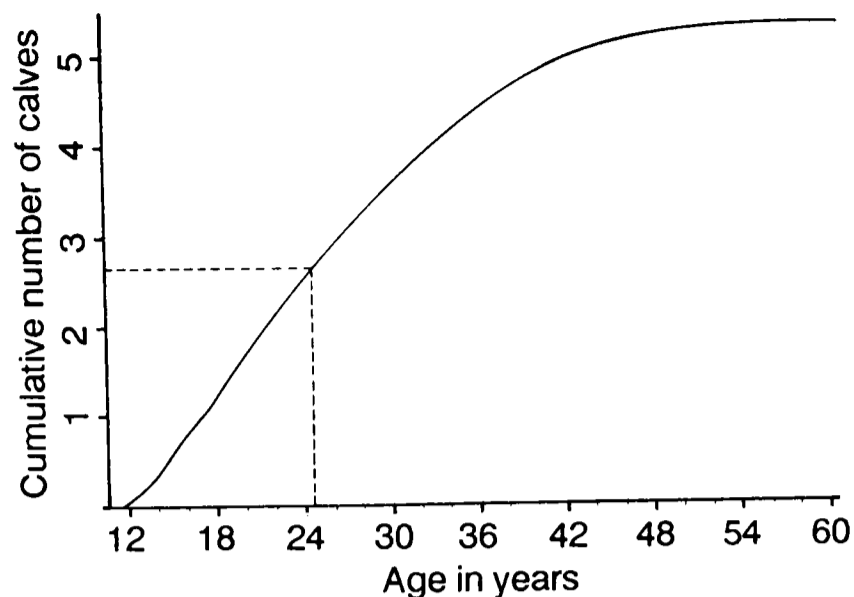

Fig. 18. Estimated mean cumulative number of viable calves that were produced by females at a given age. The two methods used to calculate this statistic (see text) gave results that were graphically indistinguishable from one another.

cases, 50% of the calves were born by 24.5 years of age (Fig. 18). These estimates agree with the maximum number of offspring assigned to mothers in genealogical trees in Bigg *et al.* (1990): 9 females had 5 offspring and 1 female had 6 offspring. The number of calves produced by females subsequent to 35 years of age was estimated at 0.95 calves; subsequent to 40 years of age at 0.45 calves; and subsequent to age 45 years at 0.13 calves.

Reproductive senescence has not been previously reported for killer whales. However, the age-specific reproductive rates of killer whales are in many ways similar to those in short-finned pilot whales (Kasuya and Marsh, 1984). In the latter species, reproductive senescence was first evident at age 28–32 years and, although female longevity extended to 63 years, all females were post-reproductive by age 40 years. However, the two species differ in one respect. In short-finned pilot whales, the estimated calving intervals increased progressively with age whereas in killer whales there was no evidence of a further decline in the fecundity of reproductive females after age 30.5 (Fig. 15). This difference may have been an artifact of the more conservative criteria used by Kasuya and Marsh (1984) to identify post-reproductive females. Some of the older females which they classified as resting or lactating may actually have been post-reproductive (Marsh and Kasuya, 1986), such that the calving intervals of older females would have been overestimated.

Interestingly, Kasuya *et al.* (1988) found little evidence of reproductive senescence in long-finned pilot whales (*G. melas*).

3.5.4 Temporal changes in fecundity

To determine whether fecundity rates varied during the course of the study, the expected annual number of births in the t^{th} year, B_t , was calculated:

$$B_t = \sum_{i=1}^n (PY_{ti(x)} \cdot FEC_{r(x)} [1 - PR_{(x)}]) \quad (30)$$

where $PY_{ti(x)}$ denotes the probability the i^{th} female was aged x in the t^{th} year as per equation (25). The deviations between B_t and the actual number of calves born each year (Tables 1 and 2) showed no temporal trend in either cropped ($r^2=0.061$; $P>0.50$) or uncropped ($r^2=0.003$; $P>0.50$) pods, which indicates that fecundity rates had remained relatively constant throughout the study.

An index of fecundity, termed the net apparent fecundity rate, was also calculated for the 20 years preceding the study (1955–74) based on the age-composition of the populations at the start of the study. The net apparent fecundity represents the number of progeny born to females during 1955–74 that survived to the start of the study. The ages of all females alive at the start of the study during 1955–74 was reconstructed by subtracting the appropriate number of years from their estimated ages at the start of the study. Using equation (30), we calculated the expected number of calves born to these females during 1955–74 and then used equation (10) to calculate the number of their calves that should have survived to the start of the study. The expected number of offspring born during 1955–74 was then compared to the observed number that survived to the start of the study based on the age-composition of the population in 1974. The analysis could only be extended as far back as 1955, because the minimum-aged adult males (Section 3.1.3) could have been born anytime prior to 1955.

The net apparent fecundity rate in uncropped pods during 1955–74 was 90.6% of its expected value (Table 8). Not surprisingly, the number of calves born in cropped pods during 1955–74 that survived to the start of the study was far below (48.6%) the number expected because many had been cropped prior to the start of the study. A correction was calculated to account for cropping. The number of cropped calves that were born during 1955–74 was estimated from the age-composition of the harvest

Table 8

Net apparent fecundity rates for the period 1955–74 (see Section 3.5.4 for details).

Key. For cropped pods: - Observed=estimated number of calves born during interval that survived to start of study; Cropped=estimated number of calves born during interval that were cropped; Rate=estimated proportion of calves born during interval that were cropped; Other=estimated number of calves born during interval to females that were cropped; Corrected=estimated number of calves born to females alive at the start of the study; (i.e. Observed and Cropped – (Rate x Other)).

Period	Uncropped pods		Cropped pods					
	Observed no.calves	Expected no.calves	Observed no.calves	No.Calves cropped	Cropping rate	Other calves	Corrected no.calves	Expected no.calves
1971-74	18	17.97	20	0.80	0.04	1.19	20.75	16.91
1967-70	8	15.53	0	9.90	1.00	3.54	6.36	16.14
1963-66	14	12.68	7	16.67	0.70	5.02	20.16	14.17
1959-62	5	9.33	3	12.33	0.80	4.52	11.71	13.26
1955-58	12	7.43	6	5.22	0.47	3.91	9.38	13.11
Total	57	62.94	36	44.92			68.36	74.13

(Section 2.3.2). Using equation (30), we estimated the number of these calves that would have been offspring of the mature females that had been cropped and, based on the overall cropping rates (Table 8), subtracted the estimated number of their offspring that would also have been cropped. The corrected net apparent fecundity rate for cropped pods was 92.2% of its expected value (Table 8).

The overall net apparent fecundity rate during 1955–74 for cropped and uncropped pods combined was 91.5% of its expected value. This implies that fecundity rates during this period were 91.5% of their current values or that juvenile mortality rates were 1.05 times their current values. Since these rates were within the 95% confidence limits of the current parameter estimates, we conclude that both fecundity and juvenile mortality rates have remained relatively constant between 1955 and 1987.

3.6 Survival and mortality rates

3.6.1 Methods

As discussed at the beginning of Section 2.3 and in Bigg *et al.* (1990), there is no evidence of dispersal of individuals from their natal pods. Thus, animals have been assumed to have died when they disappeared from their pods.

The finite annual survival rate at age x , $SV_{(x)}$, was estimated from the proportion of animals aged x in year t , $L_{x,t}$ that survived to age $x+1$ in year $t+1$, $L_{x+1,t+1}$:

$$SV_{(x)} = L_{x+1,t+1} / L_{x,t} \quad (31)$$

This is analogous to the animal-year method used by Bigg (1982) except that data for the last year individuals were seen were not included in the denominator because the status of these individuals in year $t+1$ was not yet known. The finite annual mortality rates, $MR_{(x)}$, were estimated by:

$$MR_{(x)} = D_{x,t} / L_{x,t} = 1 - SV_{(x)} \quad (32)$$

where $D_{x,t}$ represents the total number of animals that died between age x and $x+1$ during the interval t to $t+1$:

$$D_{x,t} = L_{x,t} - L_{x+1,t+1} \quad (33)$$

The variances of $SV_{(x)}$ and $MR_{(x)}$, reciprocal binomial variates, were given by:

$$\text{Var}(SV_{(x)}) = \text{Var}(MR_{(x)}) = SV_{(x)} MR_{(x)} L_{x,t}^{-1} \quad (34)$$

It should be noted that these mortality rate estimates are unique for cetaceans in that they were derived horizontally based on the fate of individuals over time. To our knowledge, previous cetacean mortality rates have all been derived vertically from, for example, the age-composition of catches. Horizontal estimates are preferable in that nothing need be assumed about the status or age-structure of the population whereas vertical estimates are valid only if the population is stationary, or is stable and the population growth rate is known. The biases introduced in vertical analyses by failure of these assumptions are discussed further in Section 4.2.7. Horizontal estimates are also statistically preferable in that they are uncorrelated:

$$\text{Cov}(SV_{(x)}, SV_{(y)}) = \text{Cov}(MR_{(x)}, MR_{(y)}) = 0 \quad \text{for } x \neq y \quad (35)$$

(Seber, 1982) whereas vertical estimates generally exhibit serial correlations.

3.6.2 Neonates

Neonate mortality is defined as that which occurred between birth and 0.5 years of age, including stillbirths. Because pods were usually censused during the

non-calving season, most calves were first identified at age 0.5 years of age. Consequently, neonate mortality can not be estimated in the same manner as other age-classes. Fortunately, an estimate of this parameter is not required in the population model as neonate mortality is absorbed into the fecundity rate, which we defined as the rate of birth of viable calves. Nevertheless, as there is evidence that neonate mortality was appreciable, we have attempted to obtain objective, albeit crude, estimates of its magnitude.

The first estimate was based on the number of neonate strandings recovered in the southern portion of the study area. A total of eight neonate carcasses were recovered from the study area during 1973–87 (Table 5). No neonate carcasses were recovered from the northern portion of the study area, almost certainly because the northern portion was much less accessible and less densely populated by people. Preliminary analyses of the DNA of four of the neonates indicated that 3 (75%) were of the resident form and 1 (25%) was of the transient form (R. Hoelzel, University of Cambridge, Cambridge, England, pers. comm.). Based on this proportion, six of the eight neonates recovered were assumed to have been of the resident form. Although all the neonates were found within the range of the southern community, three were situated on the west coast of Vancouver Island near the boundary of the two resident communities. The southern resident community commonly occur in this area while the northern resident community rarely occur there. We have therefore assumed that two of the three neonates belonged to the southern community and one to the northern community. Thus, five of the neonates were estimated to have originated from the southern resident community.

During the study, a total of 44 viable calves was born in the southern community. If we assume that all the neonates that died were recovered, the neonate mortality rate was 10% ($5/44+5$). In reality, however, the strandings probably represent only a small fraction of the total number of neonate deaths. For example, only 3 of the 26 (11.5%) whales that died in older age-classes in the southern community during the study were recovered. Applying this recovery rate to the neonate strandings gives a more realistic neonate mortality rate of 50% (i.e. $[5/0.115]/[44 + (5/0.115)]$).

The second estimate was based on the survival rates of the 15 newborn calves first encountered during winter prior to 0.5 years of age. Of these, three had died prior to the next field season at which time they would have had a mean age of 0.5 years. This represents a mortality rate of 20%, but is an underestimate as it does not account for stillbirths or mortality between birth and the first encounter. Two adjustments have been made to account for these biases. First, it was assumed that the 15 calves were born at the midpoint of the interval over which they were known to have been born (i.e. the interval between the last encounter the calf was not present and the first encounter it was present). Mortality rates were recalculated for the fraction of the interval between the estimated birth date and 1 July (i.e. mean age 0.5 years) that the calf had been monitored. Second, it was assumed that 20% of neonate deaths were stillbirths (Table 5). This gives a corrected neonate mortality rate of 37%.

Averaging the 50% and 37% estimates results in a provisional estimate of neonate mortality of approximately 43%. This is of course based on an extremely small sample size and the confidence limits associated with the estimates

are too large to be of any practical value. However, Bain (1990) independently estimated that neonate mortality in the northern community was 42% based on the distribution of calving intervals.

There are few estimates of the magnitude of neonate mortality for other cetaceans. It could be argued that data given in Kasuya and Marsh (1984) for short-finned pilot whales indicated high neonate mortality. In their sample, pregnant females outnumbered calves aged 16 months or less (i.e. the gestation period) by 60 to 20, implying a neonate mortality rate of at least 67% between birth and 16 months of age. Kasuya and Marsh (1984, p.292-3) however rejected such a high mortality rate and concluded that pregnant females were under-represented in the sample. There was also evidence of high neonate mortality in other cetaceans. Sergeant (1962) calculated that mortality in the first year of long-finned pilot whales (*G. melas*) was 35%. Captive *Tursiops truncatus* exhibited 32% mortality between 0-6 months of age and 17% mortality between 6-12 months of age (Sweeney, 1977). First-year mortality in gray whales (*Eschrichtius robustus*) was estimated at 35-36% (Swartz and Jones, 1983; Sumich and Harvey, 1986).

3.6.3 Juveniles

Since both males and females mature at about 15 years of age (Section 3.3), juvenile mortality is defined as that which occurred between 0.5 and 15.5 years of age.

Juvenile mortality rates were estimated based on the 61 individuals that were juvenile when first encountered as well as the 134 calves born during the study. To smooth irregularities and improve sample sizes, data were grouped into the following age-categories: 0.5, 1.5-2.5, 3.5-5.5, 6.5-9.5, and 10.5-14.5 years. The progressively larger intervals were selected to take advantage of the greater numbers of younger individuals, and because age-related changes in mortality rates were likely to be most pronounced in early life.

Several minor adjustments to the data were necessary. Where ages were only known to within ± 1 or ± 2 years, data were amortized over the possible age range. Similarly, the death of one animal that had died sometime during a 6-year period was amortized over this interval. Lastly, because calves born in the northern community were not all seen in the year they were born (Section 3.1.1), a correction had to be made to account for viable calves that may have died prior to being identified. The correction was calculated by applying the survival rates for calves seen every year since their birth to the 16 calves that were older than 0.5 years of age when first encountered. It was estimated that 0.30 viable calves had died prior to age 1.5 years before being identified, 0.27 prior to age 2.5 years and 0.61 prior to age 3.5 years. These deaths were partitioned among each of the age categories according to the distribution of the deaths at known ages.

Juvenile mortality rates tended to be higher in cropped pods. However, a weighted ANOVA of $Z = \arcsin \cdot X^{0.5}$ transformed mortality rates (Snedecor and Cochran, 1980) blocked by the age categories indicated that the differences were not significant ($F=0.77$; $P=0.431$). Data for cropped and uncropped pods were thus pooled. The weighted overall mean juvenile mortality rate was 0.018, but mortality rates declined with age (Table 9). Net survival from 0.5 to 15.5 years of age was calculated (${}_{0.5}^{15.5}\pi SV_{(x)}$) at 77.9%. In comparison, the survival rate of the 34 individuals that were born early in study to the end of the

study, at which time they were aged 10.5-14.5 years, was 76.5% (81.3% and 72.2% in uncropped and cropped pods, respectively). Although this did not provide a completely independent test, because the 34 animals were used in the calculation of mortality rates, these individuals accounted for only 25% of the total sample.

Table 9

Finite annual survival and mortality rates for juveniles in cropped and uncropped pods combined.

Age group	$L_{(x)}$	$L_{(x+1)}$	$D_{(x)}$	$SV_{(x)}$	$MR_{(x)}$	SE
0.5	116.2	111.5	4.7	0.960	0.040	0.0183
1.5-2.5	221.9	216.3	5.6	0.975	0.025	0.0105
3.5-5.5	296.5	290.0	6.5	0.978	0.022	0.0085
6.5-9.5	338.2	332.8	5.3	0.984	0.016	0.0068
10.5-14.5	364.0	362.0	2.0	0.995	0.005	0.0039
Total	1336.8	1312.6	24.2	0.982	0.018	0.0036

The sex of most juveniles was unknown, so mortality rates could not be calculated separately by sex. However, assuming that the sex ratio was equal at birth, differences in female and male mortality rates would be reflected by a skewed sex ratio at the onset of maturity. The sex ratios of animals that matured during the study, as well as of adolescents aged 10.5-20.5 years, were not significantly skewed (chi-squared values of 0.397 and 0.140; $P \geq 0.50$) (Table 10), which suggests that female and male juvenile mortality rates are equivalent.

To determine whether juvenile mortality rates varied over the course of the study, the expected number of juvenile deaths in 2-year intervals was calculated based on the age distribution of juveniles during each interval and the mean mortality rates (Table 9). A chi-squared test indicated that the distribution of the observed and expected deaths were not significantly different (chi-squared=3.71; $P=0.72$). Moreover, the residuals showed no consistent temporal trend ($r^2=0.041$; $P>0.50$), which indicates that juvenile mortality rates had remained constant during 1973-87. Furthermore, the constancy of the net apparent fecundity rates during 1955-74 (Section 3.5.4) suggests that juvenile mortality rates had remained constant since at least 1955.

3.6.4 Mature males

The survival and mortality rates of mature males were estimated based on the 90 males that attained ages of 15.5 years or greater during the study. As was the case for juveniles, ages known to ± 1 or ± 2 years and one death that occurred sometime during a four year period were amortized. Data were grouped into three five-year age-categories: 15.5-19.5, 20.5-24.5, and 25.5-29.5 years; and an age-category that included all males aged greater than 30.5 years. Minimum-aged male aged 21.5+ to 29.5+ were excluded from the age-specific analysis as they could not be assigned to their correct age-category.

A weighted ANOVA of $Z = \arcsin X^{0.5}$ transformed mortality rates, blocked by the above age-categories, indicated that male mortality rates in cropped and uncropped pods were not significantly different ($F=3.22$; $P=0.181$). Data for cropped and uncropped pods were therefore pooled. Mature males exhibited an overall weighted mean mortality rate of 0.039, but mortality rates increased with age (Table 11). The mortality rate increased from 0.008 for males aged 15.5-19.5, which did not differ significantly from the mortality rate of juveniles aged

Table 10

Numbers (and proportion) of animals that (1) matured; or (2) were aged 10.5-20.5 years during the study [of each sex]. Chi-squared tests indicated that none of the ratios differed significantly from parity ($P \geq 0.45$).

	Cropped pods		Uncropped pods		Combined	
	Males	Females	Males	Females	Males	Females
(1) Matured	7 (0.41)	10 (0.59)	22 (0.48)	24 (0.52)	29 (0.46)	34 (0.54)
(2) Aged 10-20	23 (0.51)	22 (0.49)	36 (0.52)	33 (0.48)	59 (0.52)	55 (0.48)

Table 11

Finite annual survival and mortality rates for mature males in cropped and uncropped pods combined.

Age group	$L_{(x)}$	$L_{(x+1)}$	$D_{(x)}$	$SV_{(x)}$	$MR_{(x)}$	SE
15.5-19.5	152.50	151.25	1.25	0.992	0.008	0.0073
20.5-24.5	165.50	159.75	5.75	0.965	0.035	0.0142
25.5-29.5	79.00	75.00	4.00	0.949	0.051	0.0247
30.5+	85.00	79.00	6.00	0.929	0.071	0.0278
21.5+-29.5+ ¹	162.00	154.00	8.00	0.951	0.049	0.0170
Total	644.00	619.00	25.00	0.961	0.039	0.0076

¹ Excluded from age-specific analysis because could not be assigned to proper age-group.

10.5-14.5 years ($P > 0.50$), to 0.071 for males aged 30.5+ years (Table 11). The exclusion of males aged 20.5+ - 29.5+ years from the analysis, which accounted for 25% of the total sample, probably had little effect. Their mortality rate was 0.049 which, as might be expected, was only slightly greater than the rate of 0.048 for non-minimum aged males greater than 20.5 years of age.

Temporal patterns in mature male mortality rates were investigated in the same manner as juveniles. The expected and observed numbers of deaths in two-year intervals were not significantly different (chi-square=6.60; $P > 0.40$) and the residuals showed no discernible temporal trend ($r^2=0.075$; $P > 0.50$), which indicates that male mortality rates were constant throughout the study.

3.6.5 Reproductive females

Reproductive females were classified as females aged 15.5 years or greater that had given birth within the past 10 years. Several of the females meeting these criteria may actually have been post-reproductive as there was no way of knowing whether those that gave birth late in the study would subsequently give birth. Data were grouped into four ten-year age-categories: 15.5-24.5, 25.5-34.5, 35.5-44.5 and 45.5-54.5 years.

Reproductive females exhibited extremely low mortality. During the study, only 1 of 32 reproductive females died in cropped pods and only 2 of 41 died in uncropped pods. These rates were not significantly different ($P > 0.50$), so data were pooled giving an overall weighted mean mortality rate of 0.0048 (Table 12). The reproductive females that died tended to be older individuals which suggests that mortality rates increased slightly with age (Table 12). Indeed, two of the females died at an estimated age of 38.5 years and thus may have actually been post-reproductive ($PR_{(38.5)}=0.41$; Section 3.5.3). There were no apparent biases to account for these low mortality rates and they could not be attributed to small sample sizes. Our sample was equivalent to three deaths among 62 females monitored for 10 years.

Table 12

Finite annual survival and mortality rates for mature females in cropped and uncropped pods combined.

Age group	$L_{(x)}$	$L_{(x+1)}$	$D_{(x)}$	$SV_{(x)}$	$MR_{(x)}$	SE
Reproductive females						
15.5-24.5	242.0	242.0	0.0	1.0000	0.0000	-
25.5-34.5	262.0	261.0	1.0	0.9962	0.0038	0.00381
35.5-44.5	118.0	116.0	2.0	0.9831	0.0169	0.01188
45.5-54.5	1.0	1.0	0.0	1.0000	0.0000	-
Total	623.0	620.0	3.0	0.9952	0.0048	0.00277
Post-reproductive females						
15.5-24.5	1.0	1.0	0.0	1.0000	0.0000	-
25.5-34.5	19.0	19.0	0.0	1.0000	0.0000	-
35.5-44.5	158.0	157.0	1.0	0.9937	0.0063	0.00631
45.5-54.5	159.0	155.0	4.0	0.9748	0.0252	0.01242
55.5-64.5	61.0	59.0	2.0	0.9672	0.0328	0.02280
≥ 65.5	29.0	27.0	2.0	0.9310	0.0690	0.04705
Total	427.0	418.0	9.0	0.9789	0.0211	0.00695
All mature females						
15.5-24.5	243.0	243.0	0.0	1.0000	0.0000	-
25.5-34.5	281.0	280.0	1.0	0.9964	0.0036	0.00355
35.5-44.5	276.0	273.0	3.0	0.9891	0.0109	0.00624
45.5-54.5	160.0	156.0	4.0	0.9750	0.0250	0.01234
55.5-64.5	61.0	59.0	2.0	0.9672	0.0328	0.02280
≥ 65.5	29.0	27.0	2.0	0.9310	0.0690	0.04705
Total	1050.0	1038.0	12.0	0.9886	0.0114	0.00328

3.6.6 Post-reproductive females

Post-reproductive females were operationally defined as mature females that had not given birth for at least 10 years. Since only 2.6% of calving intervals were greater than 10 years (Fig. 12), these females were unlikely to give birth subsequently. The population contained 37 post-reproductive females. There were insufficient numbers of post-reproductive females to compare cropped and uncropped pods, so data were pooled. Data were grouped into five ten-year age-categories: 15.5-24.5, 25.5-34.5, 35.5-44.5, 45.5-54.5, and 55.5-64.5 years; and a category that included all those aged greater than 65.5 years.

Mortality rates for post-reproductive females were extremely low prior to age 44.5, but increased with age (Table 12). A comparison of reproductive and post-reproductive females aged 25.5-34.5 and 35.5-44.5 years, the only age-categories with sufficient overlap, showed no significant differences ($P > 0.50$). Data were therefore combined and mortality rates re-calculated for all mature females (Table 12).

There was no obvious temporal pattern in the mortality rates of mature females but the paucity of deaths precluded a formal analysis.

Both female and male killer whale mortality rates (Fig. 19) conformed with the typical mammalian U-shaped pattern (Caughley, 1966). These mortality rates represent the first age-specific rates for killer whales. DeMaster and

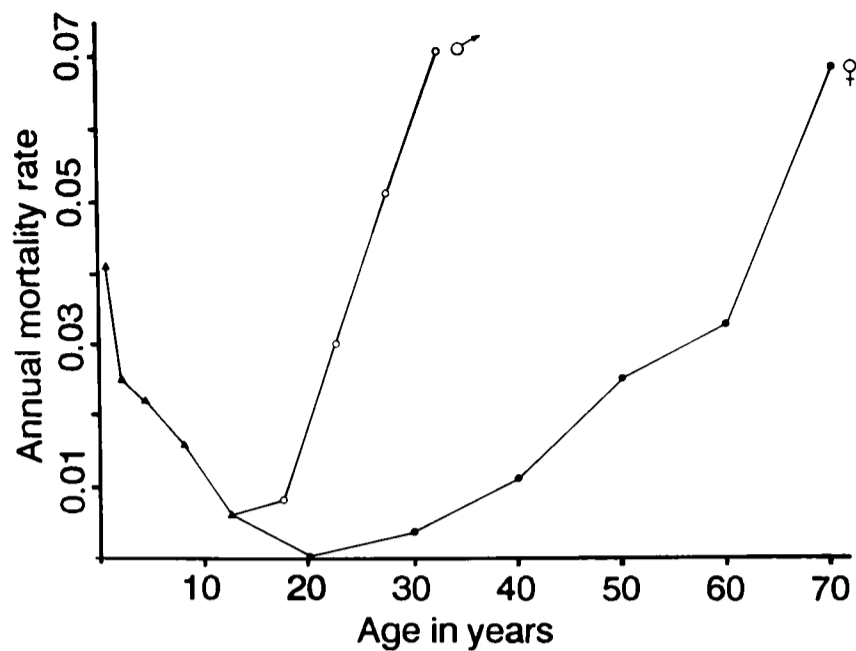

Fig. 19. Mean annual finite mortality rates ($MR_{(x)}$) as a function of age for juveniles of both sexes (triangles), mature males (\circ), and mature females (\bullet). Mortality rates were plotted at the midpoint of the age-intervals over which they applied.

Drevenak (1989) estimated annual mortality rates for captive killer whales at 0.04 for females and 0.12 for males, whereas Duffield and Miller (1988) reported annual rates of 0.089 for both captive males and females. Based on the age-composition of short-finned pilot whales taken in drive fisheries, Kasuya and Marsh (1984) calculated annual mortality rates of 0.0251 for females aged 18–47 years and 0.0393 for males aged 9–30 years, with sharp increases in mortality at older ages in both sexes. However, considering these animals would have been recruited following a period of heavy exploitation, these vertically derived rates may have been overestimates (see Section 4.2.7).

3.7 Status of the study populations

Since life history parameters often vary in a density-dependent fashion, it is important that the parameters be viewed in the context of the status of the population from which they were derived. Several observations lead us to conclude that both the northern and southern communities were at levels sufficiently below carrying capacity that density-dependent effects were not evident.

The status of the northern community was assessed on the basis of its population growth curve (Fig. 3). During the study, the size of the community increased by a factor of 1.4. Indeed, the sex- and age-structure of the population indicated that it had nearly doubled in size since 1960 (Section 4.3.2). If the northern community was approaching its carrying capacity, its population growth rate should have declined as density increased during the study. The trajectory of the northern community growth curve was evaluated with a step-wise second-order polynomial:

$$\ln N_t = [a + b t] + [c t^2] \quad (36)$$

where N_t denotes the size of the community in year t . The first-order term was forced into the regression and the improvement by adding the second-order term assessed. The procedure was in essence a derivative of DeMaster, Goodman, DeLong and Stewart's (1982) Dynamic Response Assessment (see also Boveng, 1988). The first term described an exponentially increasing population while the second term allowed for compensatory changes in the population growth rate. The analysis indicated that the growth trajectory was nearly exponential ($r^2=0.964$ for

b ; $P<0.001$) and the growth rate had not declined during the study (partial r^2 for $c = 0.001$; $P>0.50$). This conclusion was also supported by the absence of perceptible temporal trends in the life history parameters during the study.

The status of the southern community could not be assessed in the same manner because its sex- and age-structure had been distorted by the live-capture fishery (Section 4.3.3). However, the fact that the live-capture fishery had reduced the southern community to 70% of its original size and the community had not recovered to its original size (Section 4.3.3) indicated that it was also below carrying capacity. This was also supported by the similarity of the life history parameters for the southern and northern communities.

In an earlier assessment, Bigg (1982) had suggested that cropping may have affected several life history parameters. Our revised view can be attributed to the fact that smaller sample sizes were available in 1982 and that new knowledge has been acquired since then which has permitted an improved assessment (e.g. accounting for age-related effects and distinguishing between reproductive and post-reproductive females). Furthermore, a re-analysis of the data in Bigg's (1982) Tables 5–9 using chi-squared tests indicates that none of the differences reported between cropped and uncropped pods are statistically significant ($P>0.50$).

In large mammals, density dependent changes in life history parameters are generally most pronounced at population levels just below carrying capacity (Fowler, 1984; 1987). Since density dependent effects may not be apparent until populations are very close to their carrying capacity, it has not been possible to ascertain how far below carrying capacity the study populations are.

4. POPULATION DYNAMICS

4.1 Population projections

4.1.1 The model

The life history parameters were incorporated into a population model that described changes in the sex- and age-structure of a population with time. The model was discrete and projected populations in annual increments from one census period to the next. The number of animals of sex s (f =female and m =male) and pivotal age x at time t was denoted as $n_{s(x)t}$. We assumed that mortality was constant throughout the year, that births occurred as a pulse at the mid-point between censuses, and that the sex ratio was equal at birth.

The number of viable calves of each sex recruited during the interval t to $t+1$ was calculated from the number of reproductive females that survived to the next calving season, $t+0.5$, and the age-specific fecundity rates:

$$n_{s(0.5)t+1} = \sum_{x=0.5}^{90.5} n_{f(x)t} F_{(x)} \quad (37)$$

where:

$$F_{(x)} = 0.5 \cdot SV_{f(x)}^{0.5} \cdot [(MAT_{f(x+0.5)} - PR_{(x+1)}) FEC_{r(x+1)}] \quad (38)$$

with $SV_{f(x)}$ as per Tables 9 and 12, $MAT_{f(x)}$ as shown in Fig. 7, $FEC_{r(x)}$ as shown in Fig. 15, and $PR_{(x)}$ as shown in Fig. 17. The number of animals of sex s that survived to age $x+1$ at time $t+1$ was calculated from the age-specific survival rates:

$$n_{s(x+1)t+1} = n_{s(x)t} \cdot SV_{s(x)} \quad (39)$$

where $SV_{s(x)}$ was as per Tables 9, 11 and 12. Maximum longevity was set at 60.5 years for males and 90.5 years for females (i.e. $SV_{s(max)}=0$ with $max=60.5$ for m and 90.5 for f). These specific limits (see Section 4.2.6) were of little consequence in the model because such old animals constituted only a negligible proportion of the total population.

Lewis (1942) and Leslie (1945) developed matrix models that greatly simplified the above computations. Although the models were originally designed for juvenile and reproductive females, they can be extended to include post-reproductive females and males (Usher, 1972). If \mathbf{n}_t is defined as a column vector of the sex- and age-structure of the population at time t and \mathbf{M} a transition matrix as follows:

$n_t = n_{m(0.5),t}$	$M=0$	$F_{(0.5)}$	0	$F_{(1.5)}$	\dots	0	$F_{(60.5)}$	\dots	0	$F_{(90.5)}$
$n_{f(0.5),t}$	0	$F_{(0.5)}$	0	$F_{(1.5)}$	\dots	0	$F_{(60.5)}$	\dots	0	$F_{(90.5)}$
$n_{m(1.5),t}$	$SV_{m(0.5)}$	0	0	\dots	0	0	\dots	0	\dots	0
$n_{f(1.5),t}$	0	$SV_{f(0.5)}$	0	0	\dots	0	0	\dots	0	0
\dots	\dots	\dots	\dots	\dots	\dots	\dots	\dots	\dots	\dots	\dots
$n_{m(60.5),t}$	\dots	\dots	\dots	\dots	$SV_{m(60.5)}$	0	\dots	\dots	\dots	\dots
$n_{f(60.5),t}$	\dots	\dots	\dots	\dots	0	$SV_{f(60.5)}$	\dots	\dots	\dots	\dots
$n_{m(61.5),t}$	\dots	\dots	\dots	\dots	\dots	\dots	\dots	\dots	\dots	\dots
\dots	\dots	\dots	\dots	\dots	\dots	\dots	\dots	\dots	\dots	\dots
$n_{f(90.5),t}$	0	0	0	0	\dots	0	0	\dots	$SV_{f(90.5)}$	0

the sex- and age-structure of the population at time $t+1$, \mathbf{n}_{t+1} , can be obtained by:

$$\mathbf{n}_{t+1} = \mathbf{M} \cdot \mathbf{n}_t \quad (40)$$

or, more generally, the sex- and age-structure at time $t+z$, \mathbf{n}_{t+z} , by:

$$\mathbf{n}_{t+z} = \mathbf{M}^z \cdot \mathbf{n}_t \quad (41)$$

On the condition that the life history parameters remain fixed, a population will ultimately attain a stable sex- and age-distribution and will increase or decrease at a constant rate. The stable sex- and age-structure, \mathbf{n}_s , can be calculated by:

$$\mathbf{n}_s = \mathbf{M}^z \cdot \mathbf{n}_i \quad (42)$$

where the initial sex- and age-structure, \mathbf{n}_i , is irrelevant so long as z is sufficiently large. The stable rate of increase or decrease, λ , is thus:

$$\lambda = \Sigma \mathbf{n}_{s+1} / \Sigma \mathbf{n}_s \quad (43)$$

where the summation refers to all elements within the vectors. Alternatively, λ and \mathbf{n}_s can be obtained by computing the dominant eigenvalue and eigenvector of the transition matrix, \mathbf{M} . The stable population is described in Section 4.2.

For long-lived species such as cetaceans, matrix models have often been simplified by grouping age-classes into stages. However, the stage models are unrealistic and can be misleading, even in cases where the life history parameters are uniform for the age-classes grouped. Suppose, for example, that mortality rates were constant for all juveniles and they were grouped, and the stage model was then used to assess the effects of varying fecundity rates. In the stage model, juveniles would be treated uniformly and advanced to the next stage at the same rate. In reality, however, an increase in fecundity skews the juvenile component of the population toward younger age-classes such that a smaller proportion would advance to the next stage. These biases can only be avoided by setting the width of the stage-classes equal to the length of the projection increments.

4.1.2 Accuracy of the model

The population model embodies a number of simplified assumptions. Moreover, the raw data were grouped, pooled, smoothed and amortized to derive the transition probabilities of \mathbf{M} .

The validity of the model was assessed by how well it emulated the demographic changes observed in the two communities over the course of the study. Column vectors, \mathbf{P}_{jt} , were created that gave the sex- and age-structure of each pod, $j=1, \dots, 19$, in the year it was first encountered, $t=0$. Juveniles of unknown sex were partitioned equally among male and female sex-classes and ages only known to within ± 1 or ± 2 years were amortized. Minimum-aged males were amortized over their potential age-classes according to the relative frequencies of the age-classes in a stable population (Section 4.2.6). The initial sex- and age-structure of each pod was then projected for the number of years it had been monitored:

$$\mathbf{P}_{j,t+1} = \mathbf{M} \cdot \mathbf{P}_{jt} \quad (44)$$

At each iteration, the predicted numbers of births and deaths for each sex- and age-class were tabulated and categorized by sex and maturity status based on the estimated values of $MAT_{f(x)}$, $MAT_{m(x)}$ and $PR_{(x)}$ (Figs 7, 11 and 17).

In general, there is good agreement between the number of births and deaths predicted by the model and the number observed during the study (Table 13). The 122 observed viable births, plus the estimated 1.2 viable calves that died before being identified, was slightly less than the 130.2 predicted by the model. The discrepancy occurred mainly in the southern community and could be accounted for by two factors. First, the southern community contained a female (K40) that had remained barren to age 22.5 years whereas the model predicted a female would have produced 2.2 viable calves by that age. Second, the southern community contained nine females that had become post-reproductive early in the study, eight of these had been aged in reference to the year they gave birth to their last viable calf. None of the females subsequently gave birth, whereas the model assumed that females gradually became post-reproductive (Fig. 17) and gave birth to an estimated 0.45 calves subsequent to age 39.5 years (Fig. 18).

There was also a discrepancy in juvenile deaths. Although the overall predicted number of juvenile deaths of 26.0 was close to the 24.2 observed, there were more than expected in the southern community and fewer than expected in the northern community (Table 13). This was due to the slightly higher juvenile mortality rates in cropped pods. Since the mortality rates in cropped and uncropped pods were not significantly different ($P=0.431$), this discrepancy was likely due to chance.

Overall, the model satisfactorily emulated the demographic events observed during the study. It is worth noting that the population model had been derived independently and *a priori* to the above assessment of its validity.

4.2 Stable population (below carrying capacity)

In this Section, we describe the attributes of a stable population below its carrying capacity. In doing so, two classic constructs were used: life tables and Lotka's (1907a and b) population equations. Although the latter were originally derived in differential form, their finite approximations were used here. The approximations are

Table 13

Comparison of the number of births and deaths predicted by the model (and actual number observed) during the study subsequent to the first year each pod was censused.

Period	New ¹ ind	Births	Deaths				Total	Net change	Popn size
			Juvenile	Male	Reprod. F	Post. F			
Northern Community									
1973-74	54	2.73 (2)	0.44 (3)	0.64 (0)	0.05 (1)	0.07 (0)	1.20 (4)	+1.52 (-2)	55.52 (52)
1974-75	20	3.89 (5)	0.63 (0)	0.75 (0)	0.07 (0)	0.11 (1)	1.56 (1)	+2.33 (+4)	77.86 (76)
1975-76	49	5.92 (2)	1.14 (2)	1.27 (2)	0.11 (0)	0.14 (0)	2.66 (4)	+3.26 (-2)	130.11 (123)
1976-77	0	5.77 (3)	1.19 (0)	1.27 (0)	0.12 (0)	0.18 (0)	2.76 (0)	+3.01 (+3)	133.13 (126)
1977-78	0	6.04 (3)	1.20 (0)	1.26 (0)	0.14 (0)	0.19 (1)	2.79 (1)	+3.25 (+2)	136.39 (128)
1978-79	0	5.84 (9)	1.24 (0)	1.32 (1)	0.13 (0)	0.19 (0)	2.88 (1)	+2.96 (+8)	139.34 (136)
1979-80	4	6.39 (8)	1.31 (0)	1.35 (1)	0.13 (0)	0.23 (0)	3.02 (1)	+3.37 (+7)	146.69 (147)
1980-81	0	6.45 (5)	1.32 (1)	1.32 (1)	0.14 (0)	0.24 (0)	3.02 (2)	+3.43 (+3)	150.12 (150)
1981-82	0	6.55 (4)	1.33 (0)	1.33 (2)	0.14 (0)	0.24 (1)	3.04 (3)	+3.51 (+1)	153.62 (151)
1982-83	0	6.85 (8)	1.36 (0)	1.34 (4)	0.13 (0)	0.25 (0)	3.08 (4)	+3.77 (+4)	157.40 (155)
1983-84	0	7.07 (5)	1.39 (2)	1.43 (1)	0.15 (1)	0.27 (0)	3.24 (4)	+3.83 (+1)	161.21 (156)
1984-85	0	7.19 (10)	1.40 (0)	1.47 (3)	0.17 (0)	0.31 (0)	3.35 (3)	+3.84 (+7)	165.04 (163)
1985-86	0	7.60 (9)	1.43 (0)	1.49 (1)	0.17 (0)	0.34 (0)	3.43 (1)	+4.17 (+8)	169.23 (171)
1986-87 ²	0	6.31 (10)	1.18 (3)	1.46 (1)	0.13 (0)	0.36 (0)	3.13 (4)	+3.18 (+5)	147.82 (146)
Total		84.60(84.2) ³	16.58(12.2) ³	17.70 (17)	1.76 (2)	3.12 (3)	39.16(34.2) ³	+45.41(+49)	
Southern Community									
1974-75	71	3.63 (1)	0.62 (0)	0.43 (1)	0.12 (0)	0.24 (0)	1.41 (1)	+2.23 (0)	73.23 (71)
1975-76	0	3.58 (1)	0.62 (1)	0.50 (0)	0.11 (0)	0.25 (0)	1.48 (1)	+2.10 (0)	75.33 (71)
1976-77	0	3.45 (9)	0.66 (0)	0.50 (0)	0.11 (0)	0.27 (0)	1.54 (0)	+1.90 (+9)	77.23 (80)
1977-78	0	3.69 (2)	0.70 (1)	0.48 (1)	0.10 (0)	0.31 (0)	1.59 (2)	+2.10 (0)	79.33 (80)
1978-79	0	3.44 (2)	0.73 (0)	0.51 (1)	0.10 (0)	0.35 (0)	1.69 (1)	+1.75 (+1)	81.08 (81)
1979-80	0	3.58 (3)	0.75 (0)	0.54 (0)	0.11 (0)	0.40 (0)	1.80 (0)	+1.78 (+3)	82.86 (84)
1980-81	0	3.33 (1)	0.78 (2)	0.54 (1)	0.09 (0)	0.40 (0)	1.81 (3)	+1.52 (-2)	84.38 (82)
1981-82	0	3.26 (1)	0.79 (3)	0.53 (0)	0.09 (0)	0.42 (1)	1.83 (4)	+1.43 (-3)	85.81 (79)
1982-83	0	2.90 (0)	0.77 (0)	0.53 (1)	0.09 (1)	0.44 (1)	1.83 (3)	+1.07 (-3)	86.88 (76)
1983-84	0	3.25 (3)	0.74 (2)	0.57 (1)	0.08 (0)	0.44 (1)	1.84 (4)	+1.41 (-1)	88.29 (75)
1984-85	0	3.49 (5)	0.74 (0)	0.56 (1)	0.10 (0)	0.48 (1)	1.88 (2)	+1.61 (+3)	89.90 (78)
1985-86	0	3.72 (7)	0.75 (3)	0.59 (0)	0.10 (0)	0.48 (1)	1.92 (4)	+1.80 (+3)	91.70 (81)
1986-87	0	4.29 (4)	0.76 (0)	0.59 (0)	0.09 (0)	0.49 (1)	1.93 (1)	+2.36 (+3)	94.06 (84)
Total	-	45.60 (39)	9.40 (12)	6.86 (7)	1.30 (1)	4.99 (6)	22.54 (26)	+23.06(+13)	
Combined		130.20(123.2) ³	25.98(24.2) ³	24.56 (24)	3.06 (3)	8.11 (9)	61.70(60.2) ³	+68.47(+62)	

¹ Number of individuals in pods that were first identified that year. ² Based on census of some pods within community (see Table 1).

³ Expected value includes an estimated 1.2 juveniles that died before being identified.

valid because reproduction is seasonal and the age-intervals adopted were small relative to the total lifespan (Cole, 1954).

4.2.1 Life tables

Life tables were constructed for a cohort of 1,000 killer whales of each sex, s . The number of whales in the cohort that survived to age x , $L_{s(x)}$, was calculated as:

$$L_{s(x+1)} = 1000 \prod_{0.5}^x SV_{s(x)} \quad (45)$$

where values for $SV_{s(x)}$ were given in Tables 9, 11 and 12. As in the matrix model, the $L_{s(x)}$ series were truncated at 60.5 years for males and 90.5 years for females (Section 4.2.6). The number of animals dying between ages x and $x+1$ was given by:

$$d_{s(x)} = L_{s(x)} - L_{s(x+1)} \quad (46)$$

such that the age-specific finite annual mortality rates, $q_{s(x)}$, were:

$$q_{s(x)} = d_{s(x)}/L_{s(x)} \quad (47)$$

It was assumed that mortality was constant throughout the year. The number of animals that survived to the midpoint between censuses (i.e. the next calving season), $l_{s(x+0.5)}$, was:

$$l_{s(x+0.5)} = \text{antilog}[(\ln L_{s(x)} + \ln L_{s(x+1)})/2] \\ = SV_{s(x)}^{0.5} \cdot L_{s(x)} \quad (48)$$

except for the last age-classes, for which $l_{s(x+0.5)}$ was set at $0.5L_{s(x)}$. For females, the number of viable calves of each sex produced at age x was calculated from:

$$m_{(x)} = 0.5[\text{MAT}_{f(x)} (1 - \text{PR}_{(x)}) \text{FEC}_{r(x)}] \quad (49)$$

which was merely a re-parameterization of the $F_{(x)}$ in equation (38). In the matrix model, production of viable calves was calculated as $\sum L_{f(x)} F_{(x)}$ whereas in the life table it was calculated as $\sum l_{f(x)} m_{(x)}$, which gave identical results.

The female and male life tables are given in Tables 14 and 15 respectively. The fate of cohorts over time is shown graphically in Fig. 20, which indicates that 78.1% of females survived to mean age at first birth and 71.1% to mean age at onset of post-reproduction. Integrating the $L_{f(x)}$ s within each category indicates that females are, on average, juvenile for 23.7% of their lives, reproductive for 39.8% and post-reproductive for 36.5%. For males, 78.1% survived to mean age at sexual maturity and 73.4% to mean age at physical maturity. On average, males are juvenile for 42.7% of their lives, sexually but not physically mature for 15.7% and physically mature for 41.5% of their lives.

4.2.2 Life expectancy

The cumulative number of years lived by the cohort subsequent to age x , $T_{s(x)}$, was:

$$T_{s(x)} = \sum_x^{\max} l_{s(x)} \quad (50)$$

Table 14

Condensed female life table for a stable population below carrying capacity. Parameters are described in Section 4.2.

x	L _(x)	d _(x)	q _(x)	l _(x+0.5)	e _(x)	m _(x)	P _(x)
0.5	1000.0	40.5	0.0405	979.6	50.1	0.0000	1000.0
1.5	959.6	24.2	0.0252	947.4	51.2	0.0000	932.3
2.5	935.3	23.6	0.0252	923.5	51.5	0.0000	883.0
3.5	911.7	20.0	0.0219	901.7	51.9	0.0000	836.2
4.5	891.7	19.6	0.0219	881.9	52.0	0.0000	794.7
5.5	872.2	19.1	0.0219	862.6	52.2	0.0000	755.2
6.5	853.1	13.4	0.0157	846.4	52.3	0.0000	717.7
7.5	839.7	13.2	0.0157	833.1	52.1	0.0000	686.3
8.5	826.6	13.0	0.0157	820.1	52.0	0.0000	656.4
9.5	813.6	12.8	0.0157	807.2	51.8	0.0000	627.8
10.5	800.9	4.4	0.0055	798.6	51.6	0.0000	600.4
11.5	796.5	4.4	0.0055	794.3	50.9	0.0625	580.1
12.5	792.1	4.4	0.0055	789.9	50.2	0.0591	560.6
13.5	787.7	4.3	0.0055	785.6	49.4	0.1235	541.6
14.5	783.4	4.3	0.0055	781.2	48.7	0.1059	523.4
15.5	779.1	0.0	0.0000	779.1	48.0	0.1103	505.7
16.5	779.1	0.0	0.0000	779.1	47.0	0.0834	491.4
17.5	779.1	0.0	0.0000	779.1	46.0	0.1317	477.4
18.5	779.1	0.0	0.0000	779.1	45.0	0.1156	463.8
19.5	779.1	0.0	0.0000	779.1	44.0	0.1089	450.7
20.5	779.1	0.0	0.0000	779.1	43.0	0.1061	437.9
25.5	779.1	2.8	0.0036	777.7	38.0	0.0913	379.1
30.5	765.3	2.7	0.0036	764.0	33.6	0.0745	322.5
35.5	751.8	8.2	0.0109	747.7	29.2	0.0601	274.3
40.5	711.8	7.7	0.0109	707.9	25.7	0.0383	224.8
45.5	674.0	16.9	0.0250	665.5	22.0	0.0185	184.3
50.5	593.8	14.9	0.0250	586.4	19.6	0.0073	140.6
55.5	523.2	17.2	0.0328	514.6	16.9	0.0026	107.3
60.5	442.9	14.5	0.0328	435.6	14.5	0.0009	78.6
65.5	374.9	25.9	0.0690	361.7	11.7	0.0000	57.6
70.5	262.3	18.1	0.0690	253.1	10.8	0.0000	34.9
75.5	183.5	12.7	0.0690	177.0	9.4	0.0000	21.1
80.5	128.4	8.9	0.0690	123.8	7.4	0.0000	12.8
85.5	89.8	6.2	0.0690	86.6	4.6	0.0000	7.8
90.5	62.8	62.8	1.0000	31.4	0.5	0.0000	4.7

Table 15

Condensed male life table for a stable population below carrying capacity. Parameters are described in Section 4.2.

x	L _(x)	d _(x)	q _(x)	l _(x+0.5)	e _(x)	P _(x)
0.5	1000.0	40.5	0.0405	979.6	28.7	1000.0
1.5	959.6	24.2	0.0252	947.4	28.8	932.3
2.5	935.3	23.6	0.0252	923.5	28.6	883.0
3.5	911.7	20.0	0.0219	901.7	28.3	836.2
4.5	891.7	19.6	0.0219	881.9	27.9	794.7
5.5	872.2	19.1	0.0219	862.6	27.5	755.2
6.5	853.1	13.4	0.0157	846.4	27.1	717.7
7.5	839.7	13.2	0.0157	833.1	26.6	686.3
8.5	826.6	13.0	0.0157	820.1	26.0	656.4
9.5	813.6	12.8	0.0157	807.2	25.4	627.8
10.5	800.9	4.4	0.0055	798.6	24.8	600.4
11.5	796.5	4.4	0.0055	794.3	23.9	580.1
12.5	792.1	4.4	0.0055	789.9	23.0	560.6
13.5	787.7	4.3	0.0055	785.6	22.2	541.6
14.5	783.4	4.3	0.0055	781.2	21.3	523.4
15.5	779.1	6.4	0.0082	775.9	20.4	505.7
16.5	772.7	6.3	0.0082	769.5	19.6	487.3
17.5	766.4	6.3	0.0082	763.2	18.7	469.6
18.5	760.1	6.2	0.0082	757.0	17.9	452.5
19.5	753.9	6.2	0.0082	750.8	17.0	436.1
20.5	747.7	26.0	0.0347	734.6	16.2	420.2
25.5	626.5	31.7	0.0506	610.4	13.8	304.9
30.5	483.2	34.1	0.0706	465.8	12.2	203.6
35.5	335.1	23.7	0.0706	323.0	11.6	122.2
40.5	232.4	16.4	0.0706	224.0	10.6	73.4
45.5	161.2	11.4	0.0706	155.4	9.3	44.1
50.5	111.8	7.9	0.0706	107.7	7.3	26.5
55.5	77.5	5.5	0.0706	74.7	4.5	15.9
60.5	53.8	53.8	1.0000	26.8	0.5	9.5

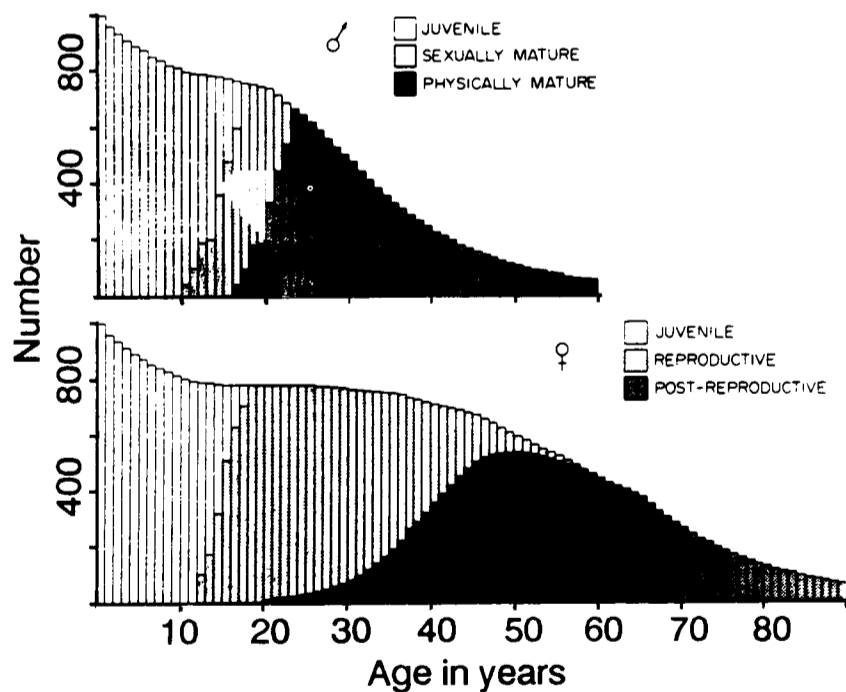

Fig. 20. Horizontal perspective of the sex- and age-structure of a male (top) and female (bottom) cohort in a stable population below carrying capacity. This figure shows the change in size of a cohort of each sex followed over time as it ages (see Sections 4.2.1 and 4.2.7 for details).

from which can be calculated the future life expectancy at age x, $e_{s(x)}$:

$$e_{s(x)} = T_{s(x)} / L_{s(x)} \quad (51)$$

The mean life expectancy of viable calves aged 0.5 years was 50.1 years for females and 28.7 years for males (Tables 14 and 15). The life expectancy of females increased slightly to 52.3 years by age 6.5 years because females that

survived their first few vulnerable years did not experience appreciable mortality until the end of their reproductive lifespan. In contrast, the life expectancy of males declined with age subsequent to 1.5 years because those that survive their first few vulnerable years face relatively higher mortality at the onset of physical maturity.

The above life expectancies were calculated at pivotal ages. Due to the high incidence of neonate mortality, life expectancy at birth is considerably less than that at 0.5 years. Based on the neonate mortality estimate of 43% (Section 3.6.2), such that $l_0 = 1,000 / (1 - 0.43)$, and transposing the $L_{(x)}$ and $l_{(x)}$ series in equations (50) and (51), the life expectancy at birth was calculated to be 28.9 and 16.6 years for females and males, respectively.

4.2.3 Stable (intrinsic) rate of increase

The stable rate of increase, r , was obtained iteratively using Lotka's (1907) first equation:

$$\sum_{x=0.5}^{90.5} e^{-rx} l_{(x)} m_{(x)} = 1 \quad (52)$$

which gave $r = 0.0288$. It should be noted that the $L_{(x)}$ and $l_{(x)}$ series were rescaled to an initial cohort of 1 for computations involving Lotka's equations. The corresponding finite growth rate, λ , was:

$$\lambda = e^r = 1.0292 \quad (53)$$

which indicates that the stable population increased at a rate of 2.92% per annum. An identical value was obtained using equation (43). This rate of increase applied to all sex- and age-classes in the population. At this rate, populations would double in size every 24.1 years.

The study population was below its carrying capacity and increasing exponentially (Section 3.7), so λ represents the maximum or intrinsic rate of increase for killer whales within the study area.

4.2.4 Reproductive potential and generation time

The net reproductive rate at age x , $R_{(x)}$, was calculated by:

$$R_{(x)} = \sum_x^{90.5} l_{(x)} m_{(x)} \quad (54)$$

which represents the expected number of viable progeny of both sexes produced by females subsequent to a given age. The reproductive rate increased from 4.08 at 0.5 years of age to 5.03 at 11.5 years (Fig. 21) as the proportion of females that survived to reproduce increased. The reproductive rate at age 11.5 years was 93.5% of the 5.38 calves that were produced by females that survived to the end of their reproductive lifespan (Section 3.5.3) because reproductive females exhibited extremely low mortality rates. The reproductive rate declined beyond 13.5 years of age, not so much because of mortality, but almost entirely because females had expended their reproductive potential.

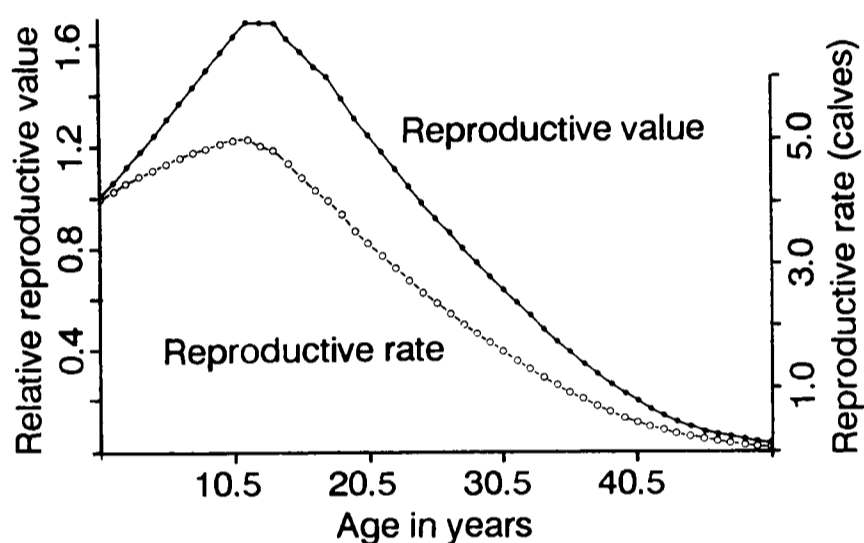

Fig. 21. Reproductive potential of females as a function of age. The reproductive rate ($R_{(x)}$) (bottom) represents the mean number of progeny produced by an individual subsequent to age x . The reproductive value ($RV_{(x)}$) (top) represents the relative number of progeny produced by an age-class subsequent to age x .

A related statistic was the relative reproductive value, $RV_{(x)}$, of females (Fisher, 1929):

$$RV_{(x)} = e^{rx} / l_x \sum_{y=0.5}^{90.5} e^{-ry} l_y m_y \quad (55)$$

which, expressed as a multiple of $RV_{(0.5)}$, provides an index of the relative reproductive value of each female age-class in the population. The relative reproductive values follow the same general pattern as the reproductive rates (Fig. 21) but the variations are more pronounced owing to the greater prevalence of younger age-classes in the population.

The mean generation time, G , was approximately equal to:

$$G = 0.5 \cdot \ln R_{(0.5)} / r = 24.8 \text{ years} \quad (56)$$

which represents the mean interval between the birth date of a female and the mean of the birth date of her progeny. Because the generation time was less than the life expectancy of females, the population was comprised of overlapping generations. Considering that the mean life expectancy of females is about double (2.02 times) the mean generation time, it would be expected that approximately half of all offspring would have living grandmothers at birth. Indeed, the genealogical trees described in Bigg *et al.* (1990), which were constructed prior to the population assessment, indicated that 39 of the 80 (48.8%) offspring born in uncropped pods during the study had living grandmothers at birth.

4.2.5 Birth and death rates

The finite female birth rate, β_f , was obtained from Lotka's (1907) second equation:

$$1/\beta_f = \sum_{x=0.5}^{90.5} l_{(x)} e^{-r(x+1)} \quad (57)$$

which gives $\beta_f = 0.04522$. This represents the mean number of viable female progeny born per annum per female, including both immature and mature females. Since an equal number of male progeny were born, and females constituted 56.4% of the stable population (Section 4.2.6), the total *per capita* birth rate, β_t , is 0.05103 progeny per animal per year.

The finite female death rate, δ_f , was estimated as:

$$\delta_f = \beta_f (\lambda - 1) = 0.01599 \quad (58)$$

which represents the number of female deaths per female per annum. Since the stable population comprised 56.4% females, the total *per capita* female death rate is 0.00902. Substituting the total *per capita* birth rate, β_t , into equation (58) gives a total *per capita* death rate, δ_t , of 0.02180. By subtraction, the male *per capita* death rate, δ_m , was estimated to be 0.01278 (0.02931 male deaths per male). Although equal numbers of males and females were born each year, fewer females died each year. However, this does not imply that the female segment of the population was increasing faster than the male segment. Both males and females increased at 2.92% per annum, but in absolute terms more females had to be added each year to maintain the skewed sex ratio.

The birth to death ratio perhaps provides the most meaningful comparison for populations with different generation times and longevity. In the stable killer whale population, births outnumbered deaths by a factor of 2.34:1 (2.83:1 for females and 2.00:1 for males). This is high for a marine mammal. In comparison, a harbour seal (*Phoca vitulina*) population increasing at its intrinsic rate of 12.5% per annum exhibited a birth to death ratio of only about 2:1 (Olesiuk, unpubl. data). Thus, while a net rate of increase of 2.92% appears modest, it represented an impressive rate of increase for such a long-lived species.

4.2.6 Stable sex- and age-structure

Populations are comprised of a series of cohorts that start life at different times. Unless populations are stationary (i.e. $r=0$ or $\lambda=1$), the initial size of the cohorts varies with time. As a result, the stable sex- and age-structure of the population differs from that of a cohort followed through time, the degree of difference being a function of the rate of population growth.

The stable sex- and age-structure, $P_{s(x)}$, was obtained using Lotka's (1907) third equation:

$$P_{s(x)} = \beta_s L_{s(x)} e^{-r(x+1)} \quad (59)$$

This is identical to the structure given by equation (42).

The stable sex- and age-structure of the stable killer whale population is shown in Fig. 22. Integrating the $P_{(x)}$ and $P_{m(x)}$ indicates that the stable population comprised 56.4% females and 43.6% males. The sex ratios become more skewed with age. For example, 62.4% of mature animals are female. Overall, the stable population comprises 50.3% juveniles (50.5% female), 18.7% mature males (64.0% physically mature) and 31.0% mature females (69.2% were reproductive).

At this point, the rationale for truncating the $L_{s(x)}$ series at 60.5 years for males and 90.5 years for females can be explained. The truncation points represent the ages,

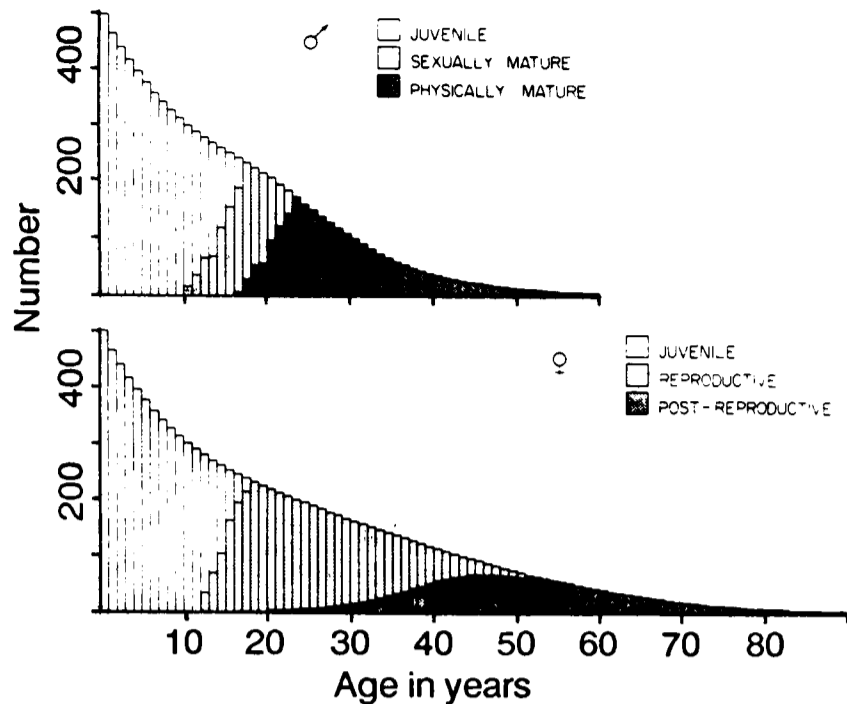

Fig. 22. Vertical perspective of the sex- and age-structure of males (top) and females (bottom) in a population below carrying capacity. The population is the same as that showed in Fig. 21 viewed from a different perspective. This figure shows the sex- and age-composition of the population (i.e. a series of cohorts recruited over a series of years) at any given point in time (see Sections 4.2.6 and 4.2.7 for details).

rounded to the nearest 10 years, by which the prevalence of the age-class in a stable population has diminished to less than 1% of the number of new recruits. Because older animals constituted only a small fraction of the total population, and all older females were post-reproductive, the exact truncation point is not critical. For example, females aged greater than 70.5 years comprised only 1.2% of the stable population whereas those aged greater than 81.5 years only 0.3%. These values are in accord with the direct estimates of female longevity (Section 3.1.4). Similarly, males aged older than 41.5 years comprised only 3.3% of the stable population and those greater than 51.5 years only 0.9%.

4.2.7 Horizontal versus vertical analysis

The preceding analyses provide two perspectives of the sex- and age-structure of the stable population. Fig. 20 gave a horizontal (longitudinal) perspective. This figure showed the fate of a particular cohort followed through time as it aged. The cohort declined in size with age (time) due to mortality. For example, the number of males aged 10.5 years was only 80.1% the number aged 0.5 years because only 80.1% of the cohort survived to age 10.5 years.

Fig. 22 gives a vertical (latitudinal) perspective of the stable population. This figure shows the sex- and age-structure of the population at a given point in time. The sizes of age-classes decline with age not only because of mortality, but also because of the increasing population. For example, the number of males in the 10.5 year age-class was only 60.0% of the number in the 0.5 year age-class because 80.1% of 10.5 year age-class had died since they were born into the population 10.5 years ago; and also because the population had grown in size such that the number of males recruited into the population 10.5 years ago was only 75.0% of the number recruited 0.5 years ago.

In most population assessments, horizontal data are unavailable and mortality and survival rates are inferred vertically from the age-composition of catches. As evident in Figs 20 and 22, this can lead to serious biases when the

population is non-stationary. If the population growth rate is precisely known, the age-structure can be adjusted to account for these biases. However, in many cases, precise information on population trends are unavailable and stationarity is assumed.

Since both horizontal and vertical data are available for the study population, it provides an opportunity to evaluate the biases introduced by non-stationarity in vertical analyses. The magnitude of bias was assessed by analyzing the stable sex- and age-structure of the population as if the population was stationary. This was done by simply substituting the $P_{s(x)}$ s for the $L_{s(x)}$ s in the life table and recalculating the population parameters. The exercise can be considered realistic in that the population growth rate of 2.92% was probably too small to have been discernible using conventional censusing methods.

Mortality rates were overestimated in the vertical analysis because the decline in the size of the age-classes with age was not entirely due to deaths, but was also partly due to the fact that the initial size of cohorts was increasing with time. The magnitude of bias, expressed as a multiplier of the true mortality rate, was a function of the population growth rate, λ , and the true mortality rate, $MR_{(x)}$:

$$\text{Bias} = (1 - [(1 - MR_{(x)})/\lambda]) / MR_{(x)} \quad (60)$$

For example, for $MR_{(x)} = 0.01777$ and $\lambda = 1.0292$, the mean *per capita* death rate and finite rate of increase in the stable population (Sections 4.2.5 and 4.2.3), mortality rates are overestimated by a factor of 2.55. The degree of bias is greater for age-classes exhibiting low mortality, such as reproductive females, and less for age-classes exhibiting high mortality, such as juveniles.

The biased mortality rates substantially bias other population parameters (Table 16). However, the biased stable sex- and age-structure was, within computational error, identical to the unbiased stable sex- and age-structure of the population (Fig. 23). Thus, internal consistency checks would not have revealed that something was amiss.

The above exercise indicates that small departures from stationarity, likely too small to discern using traditional censusing methods, may introduce serious distortions in vertical population assessments. Such biases will occur whenever populations are below their carrying capacity, which would include populations that were being exploited or were recovering from exploitation. Indeed, the biases

Table 16

Biases in select population parameters resulting from non-stationarity ($\lambda = 2.92\%$) in a vertical population analysis.

Life history parameter:	Stable:	Stationary:
<i>Life expectancy:</i>		
Male at age 0.5years	50.1 yrs	23.1 yrs
Female at age 0.5years	28.7 yrs	17.7 yrs
<i>Survival:</i>		
Both sexes to maturation (age15.5)	77.9%	50.6%
Female to post-reproduction (age 40.5)	71.2%	22.5%
Male to physical maturity (age 21.5)	72.2%	39.4%
<i>Net reproductive rate</i>		
(number of male and female calves)	4.08 calves	2.02 calves
<i>Sex ratio</i> (females:males)	1.30:1	1.29:1
<i>Finite rates:</i>		
Total death, <i>per capita</i>	0.02180	0.0488
Total birth, <i>per capita</i>	0.05103	0.0495
Population increase	2.92%	0.06%

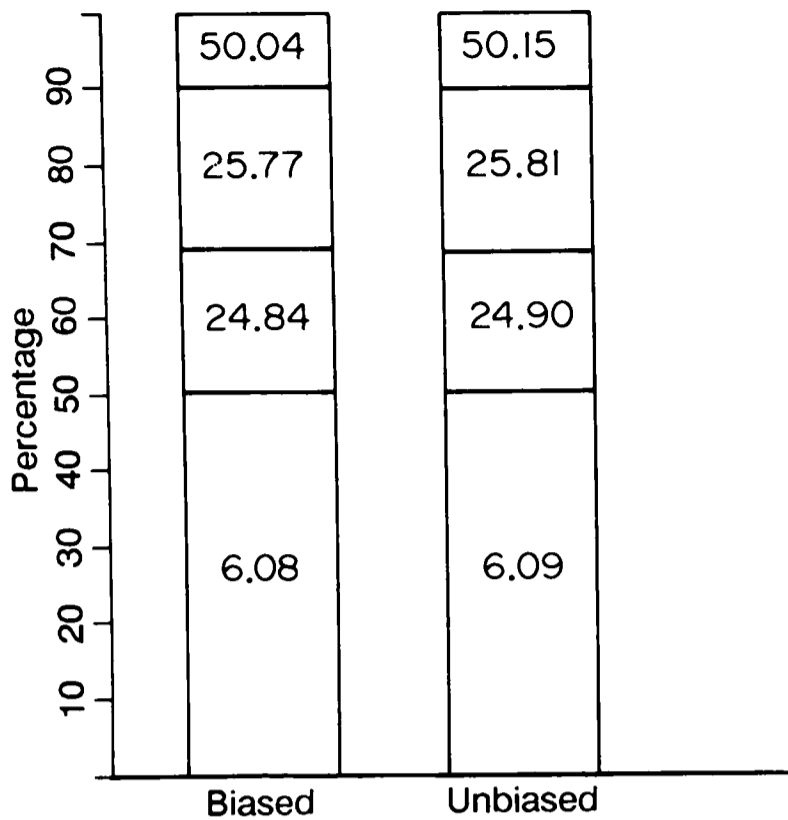

Fig. 23. Comparison of the actual (unbiased) sex- and age-structure in a stable population and the biased sex- and age-structure predicted by a vertical analysis assuming stationarity. The population is partitioned into, from bottom to top: juveniles, mature males, reproductive females and post-reproductive females. The numbers within each partition represent the mean age of animals in each category.

would persist in the older age-classes that had been recruited while the population was being exploited or recovering for considerable periods after the population had recovered. Since the implications of these biases are widely applicable to cetacean populations, future vertical population assessments should be subjected to sensitivity analyses to determine the effects of non-stationarity.

4.2.8 Sustainable harvests

Since the study populations were below carrying capacity and increasing exponentially at their intrinsic rate (Sections 3.7 and 4.2.3), the growth of the population represented the maximum surplus production that could be harvested on a sustained basis.

Assuming the harvest was taken just after the summer census and prior to the next calving season, we estimated the maximum sustainable non-selective harvest rate, HR_n , to be:

$$HR_n = (\lambda - 1)/\lambda = 0.0284 \quad (61)$$

which indicates that if 2.84% of each sex- and age-class was removed each year, the population would show no net change in size. The non-selective harvest would have no effect on the sex- and age-structure of the population.

In practice, fisheries are usually selective for particular sex- and/or age-classes. The impact of a selective harvesting regime can be assessed with the matrix projection model. Defining \mathbf{H} as a matrix (of the same order as \mathbf{M}) giving the rate of harvest of each sex- and age-class, $HR_{s(x)}$:

$\mathbf{H} =$	$HR_{m(0.5)}$	0	0	0	0
	0	$HR_{f(0.5)}$	0	0	0
	0	0	$HR_{m(1.5)}$	0	0
	0	0	0	$HR_{f(1.5)}$	0
	$HR_{f(90.5)}$

the size and sex- and age-structure of the harvested population at time $t+1$, \mathbf{n}_{t+1} , can be obtained by:

$$\mathbf{n}_{t+1} = \mathbf{M} \cdot \mathbf{H} \cdot \mathbf{n}_t \quad (62)$$

By projecting the harvested population for a sufficient period (equations (42) and (43)), the long-term impact of the harvesting regime on the rate of increase and structure of the population can be ascertained. Using this procedure, we iteratively established sustainable (i.e. $\lambda=1$) configurations of \mathbf{H} .

Sustainable $HR_{s(x)}$ s were derived for two types of fisheries: one that targeted exclusively juveniles aged 0.5 to 14.5 years, and one that targeted exclusively adults aged ≥ 15.5 years. In both cases, the fishery was assumed to be non-selective within these age ranges. The population was able to sustain the removal of 4.70% of juveniles each year. Since juveniles comprised 40.3% of the resulting stable population (Fig. 24), this represents a total population harvest level of 1.89%, of which half is female. Alternatively, the population was able to sustain the removal of 8.43% of adults each year. Since adults comprised 37.7% of the stable population (Fig. 24) this represents a total population harvest level of 3.17%. Due to the skewed adult sex ratio (Fig. 24), the harvest would comprise 54.7% females (88.8% reproductive).

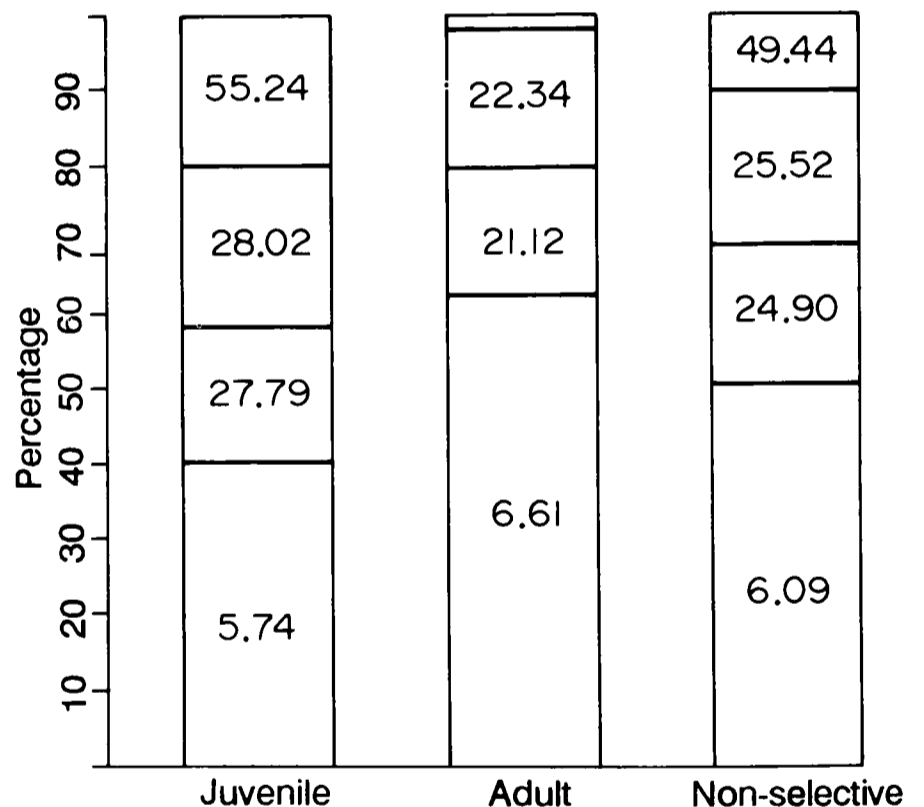

Fig. 24. Effect of sustainable juvenile, adult and non-selective harvests on the stable sex- and age-structure of a population. The population is partitioned into, from bottom to top: juveniles, mature males, reproductive females and post-reproductive females. The numbers within each partition represent the mean age of animals within each category.

This analysis indicates, rather surprisingly, that the population is more sensitive to removals of juveniles than mature animals. This is due to the high reproductive value of juveniles compared to mature females (Fig. 21). In general, the relative sensitivity of the population to the removal of an animal of a given age is directly proportional to the animal's reproductive rate; and the sensitivity of the population to the removal of a given age-class is directly proportional to the age-class's relative reproductive value (Fig. 21).

The harvests outlined in the preceding paragraph were limited only by the removal of females, as males made no direct contribution to recruitment. In many populations,

particularly of polygamous species, harvest levels can be increased by targeting males. In our simplified model, the male harvests were limited only by the recruitment rate of males. For example, if all males in the stable population were harvested at birth, the sustainable harvest level would be equivalent to the male birth rate per female (Section 4.2.5), which represents a harvest level of 4.52% of the total population. Such a population would be completely devoid of males. Alternatively, removing all males as they attain sexual maturity results in a sustainable male harvest of 3.13% of the total population, which would be completely devoid of sexually mature males. Thus, the population is able to sustain only relatively small male harvests simply because their recruitment rates are so low.

All of the above harvesting rates probably overestimated the actual sustainable harvests because only the direct demographic contribution of animals was considered. Consequently, the removal of males and post-reproductive females had no effect because they made no direct contribution to recruitment. In reality, however, these animals likely make some social contribution. For example, at least some mature males are required for mating and post-reproductive females may play a role in the rearing of young, but these contributions cannot be quantified at present. Moreover, the removal of one animal may adversely affect the survival of other animals. For example, the death of females might also increase the likelihood of the death of their dependent offspring.

4.3 Stock assessment

The population model has provided a framework for examining the dynamics of the northern and southern communities during and prior to the study. Initially, we used the model to compare the observed sex- and age-structure of the two communities during the study to the predicted stable sex- and age-structure. This comparison serves two purposes. On the one hand, it provides an independent assessment of the validity of the population model. The assessment was in fact independent because the life history parameters were derived horizontally and were therefore in no way contingent upon the vertical sex- and age-structure of the study population. On the other hand, discrepancies between the observed and predicted sex- and age-structure provide insight into how departures from the model or stochastic events affect real populations. Secondly, the model was used to reconstruct population trends since 1960 to assess the impact of the live-capture fishery.

The above analyses are inseparable. The current sex- and age-structure could not have been evaluated without accounting for distortions that may have been introduced by selective cropping. Conversely, the reconstruction of the historic population was based on the current sex- and age-structure of the population.

4.3.1 Methods

The effect of cropping on the sex- and age-structure observed during the study was assessed by correcting the observed structure for cropping. The corrected sex- and age-structure in year t , \mathbf{c}_t , was obtained by projecting the sex- and age-structure of the harvest taken in each of i years in which there was a harvest to time t , \mathbf{h}_{it} , and adding it to the observed sex- and age-structure in year t , \mathbf{a}_t :

$$\mathbf{c}_t = \mathbf{a}_t + \sum_{i=1962}^{1977} \mathbf{h}_{it} \quad (63)$$

where \mathbf{h}_{it} was obtained by:

$$\mathbf{h}_{it} = \mathbf{M}^{t-j} \cdot \mathbf{h}_{ij} \quad (\text{with } i=j) \quad (64)$$

and where \mathbf{a}_t , \mathbf{c}_t and \mathbf{h}_{it} represent column vectors and \mathbf{M} the transition matrix as defined in Section 4.1.1. For instance, the impact of the 1962 harvest on the sex- and age-structure in 1975 was determined by projecting the estimated sex- and age-structure of animals cropped in 1962 to 1975 (i.e. $\mathbf{h}_{62,75} = \mathbf{M}^{13} \mathbf{h}_{62,62}$) and adding it to the observed structure in 1975. The sex- and age-structure of the harvest in the year it was taken (\mathbf{h}_{ij} with $i=j$) was estimated based on the sex and size of the cropped animals (Table 3). The four cropped animals of unknown sex were partitioned equally among females and males. Cropped animals were amortized over the age ranges corresponding to their size (Section 2.4.2) according to the relative frequencies of the age-classes in a stable population (Section 4.2.6). Since the cropped animals were predominately juveniles, the age estimates were reasonably precise.

To simplify comparison of the observed and corrected sex- and age-structures, animals were categorized as either juveniles, mature males, reproductive females or post-reproductive females. Since there was no way of knowing whether females that were reproductive late in the study would subsequently give birth, they were partitioned among reproductive and post-reproductive categories based on their estimated ages and the $\text{PR}_{(x)s}$ (Fig. 17). The mean age of animals within each category was calculated as an index of its age composition.

The impact of the live-capture fishery on each community was assessed by projecting the size of each community back to 1960. Normally, the size and sex- and age-structure in year $t-1$ could have been obtained by multiplying the structure in year t by the inverse of the transition matrix, \mathbf{M} . However, since the model had been extended to include males and post-reproductive females, it was not of Leslie form and \mathbf{M}^{-1} was undefined. Alternatively, the number of animals in year $t-1$ in all but the oldest age-classes was estimated by:

$$n_{s(x-1)t-1} = n_{s(x)t} / \text{SV}_{s(x-1)} \quad (65)$$

and the number in the oldest age-class by:

$$n_{s(x)t-1} = \sum_{x=0.5}^{\max} \text{MAT}_{s(x)} \cdot n_{s(x-1)t-1} \cdot \text{PL}_s \quad (66)$$

where values for $\text{MAT}_{f(x)}$ and $\text{MAT}_{m(x)}$ were given in Tables 6 and 7 and the PL_s denoted the proportion of the mature animals of sex s that died in the last age-class in a stable population ($\text{PL}_f = 0.036\%$ and $\text{PL}_m = 0.122\%$).

4.3.2 Northern community

The observed and corrected sex- and age-structure of the northern community nearly coincide (Fig. 25a). The predicted rate of increase of the corrected population over the course of the study, calculated as per sections 2.3.1 and 2.3.2, is 2.65%, which is similar to the observed rate of 2.62% (Section 2.3.1). The absence of an appreciable cropping effect can be explained by the fact that relatively few animals (15) were cropped from the community and there was no pronounced bias toward either sex (7 females and 8 males).

The sex- and age-structure of the northern community generally conforms with that of a stable population (Fig. 25a). Overall, the weighted mean corrected population comprised slightly too few juveniles (47.0% observed vs 50.3% expected) and too many mature males (24.1% vs

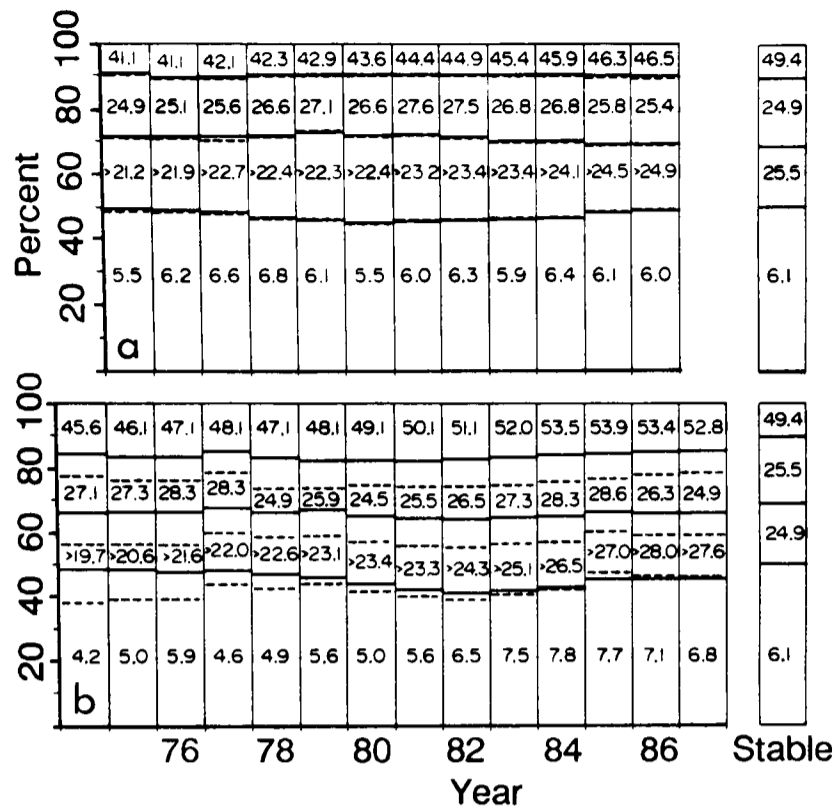

Fig. 25. The observed sex- and age- structure (solid lines) and the sex- and age-structure corrected for cropping (dashed lines) during the study in: a) the northern community; and b) the southern community. The observed and corrected populations are partitioned into, from bottom to top: juveniles, mature males, reproductive females and post-reproductive females. The numbers within each partition represent the observed mean ages of animals within each category.

18.7%) but roughly the expected number of reproductive (19.3% vs 20.8%) and post-reproductive females (9.6% vs 10.3%). The mean ages within each category are also similar to those expected in a stable population (Fig. 25a). Note that the mean minimum age of males converged on its expected value during the study as the errors inherent in the minimums diminished (e.g. a male aged 20+ years at the start of the study would have been aged 35+ years by the end of the study).

Fig. 25a also illustrates the subtle patterns that can arise due to the stochastic nature of the demographic events. Although essentially equal numbers of males and females matured during the study (22 males and 24 females), the majority of males (15 of 22) matured prior to 1981 and the majority of females (18 of 24) after 1981. As a result, during 1975–81 the sex ratio of mature animals became skewed toward males, recruitment rates declined and the proportion of juveniles decreased. Conversely, during 1982–86 more females than males matured and the above trend was reversed. By 1987, the population had returned to a stable sex- and age-structure. However, due to the 'bulge' in the number of mature males during the middle of the study (Fig. 25a), there were on average only 92.8% as many reproductive females as in a stable population. This largely explains why the observed rate of increase during the study of 2.65% was only 90.8% of the 2.92% expected in a stable population.

The back-projections indicate that, despite the removal of 15 animals during the live-capture fishery, the northern community has been increasing in size since at least 1960 (Fig. 26a). The high net apparent fecundity between 1955–74 (Table 8) and stable sex- and age-structure of the community supports this finding. The mean annual rate of increase during 1960–75 was estimated at 1.90%. However, during this period the community was harvested

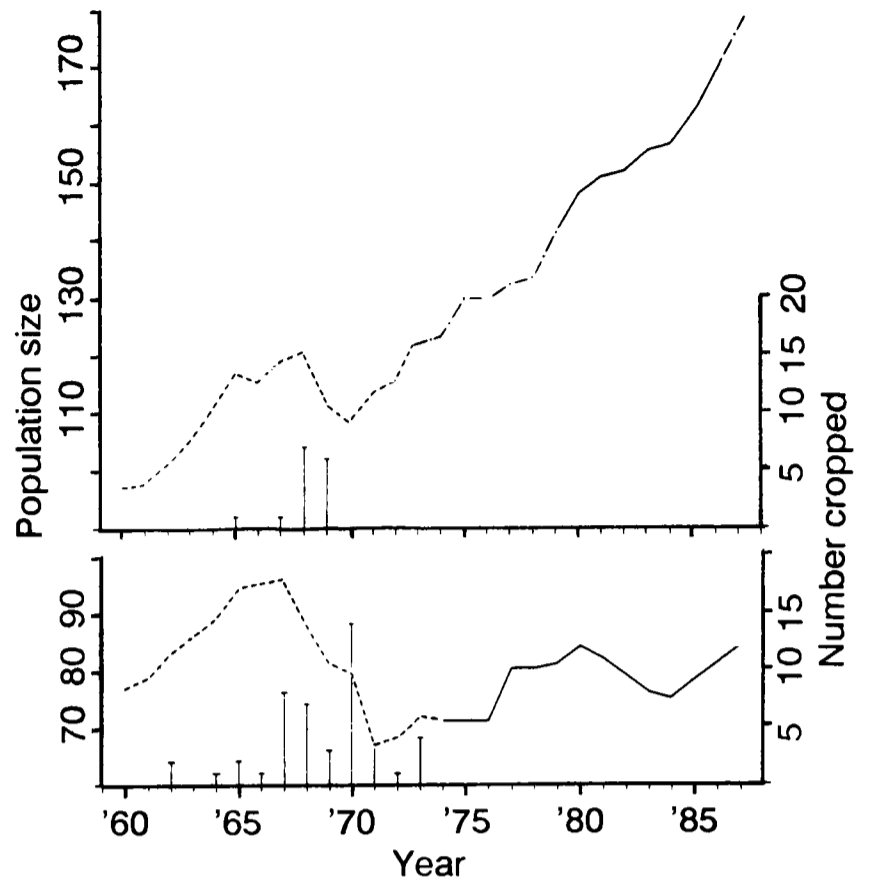

Fig. 26. Population trends during 1960–87 in: a) the northern community; and b) the southern community. Dashed lines indicate that the population trends were projected with the matrix model; solid lines indicate that the population trends were based on complete censuses of all pods in the community; and broken lines indicate that some pods were censused and the size of others projected. The vertical bars indicate the estimated number of animals removed from the community during the live-capture fishery.

at a mean weighted rate of 0.83%. Thus, the total rate of production is about 2.73%, which represents 94% of the 2.92% expected rate for a stable population.

The growth of the northern community during the study could not be attributed to recovery from the live-capture fishery. It therefore implies that the population had been depleted prior to 1955–60, or that the carrying capacity has increased in recent years. With respect to depletion, it is possible that indiscriminate killing by fishermen and practice bombings (Section 2.4.1) exceeded the current non-selective sustainable kill of 5.1 animals *per annum* and depleted the population. Since it is not known what resources limit population size, nothing can be said at present concerning changes in carrying capacity.

4.3.3 Southern community

The assessment of the southern community was more complex than that of the northern community. Comparison of the observed and corrected sex- and age-structure of the community (Fig. 25b) indicates that the observed structure was distorted by selective cropping. Early in the study (1974–79), the observed population comprised too few juveniles (41.4% vs 50.1%) and these juveniles tended to be younger than expected (mean age 5.0 years vs 6.1 years) and their sex ratio was biased toward females (63.0% females vs 50.5%). The sex ratio of mature animals was also skewed toward females (2.4–2.6:1 vs 1.70:1).

These discrepancies can be largely attributed to selective cropping (Fig. 25b). Most importantly, juveniles (particularly males) and mature males were under-represented during the study because of the large number of immature males (23 males vs 12 females) that were cropped. The minimum mean age of males also increased during the

study more rapidly than in the northern community because few males matured during the study (see also Table 10) due to the cropping of juvenile males.

When corrected for cropping, the 1974–79 sex- and age-structure of the southern community generally conforms to that of a stable population (47.9% vs 50.3% juveniles, 19.0% vs 18.7% mature males and 33.1% vs 31.0% mature females). Similarly the corrected sex composition of juveniles (49.1% females vs 50.5%) and the mature sex ratio (1.74:1 versus 1.70:1) were close to their expected values.

However, the discrepancy in the ratio of reproductive to post-reproductive females cannot be fully attributed to cropping. During 1974–79, only 42.9% of all mature females in the southern community were reproductive compared to the expected value of 66.9% in a stable population. Because few mature females were cropped, the corrected proportion of reproductive females, 50.1%, was also below the expected value. This aberration appears to have developed recently. During 1973–77, 9 of the 20 (45%) reproductive females in the community gave birth to their last viable calves. Thus, an estimated 65.6% of mature females were reproductive in 1972, which was close to the expected value of 66.9%.

Why so many females stopped calving over such a short period is unclear. During 1973–77, females stopped calving at a mean annual rate of 11.2%, which was about 4.5 times the steady-state rate of the onset of post-reproduction of 2.5% in a stable population. Unfortunately, the precise ages of the females in question could not be established because they likely had progeny cropped. In fact, eight of the nine were aged in reference to the year they last gave birth. One possible explanation is that the cropping of males had reduced the number of mature males in the community below a critical number for optimal productivity. During 1974–79, there were only 12–13 mature males in the community and only 10–11 of these were physically mature. Had the nine females in question remained reproductive, the mature male to reproductive female ratio would have declined to 0.57–0.65. However, because so many females stopped calving, the mature male to reproductive female ratio was maintained at 0.91, which was close to the 0.90 ratio in a stable population.

Whatever the underlying cause, the disproportionately low number of reproductive females at the start of the study resulted in lower productivity throughout the study. Moreover, the situation was further exacerbated by cropping. Because juvenile females were cropped prior to the study, fewer females matured than expected and the shortage of reproductive females persisted longer than it otherwise would have. During the study, a weighted mean of 52.3% of females were reproductive in the corrected population whereas only 43.2% were reproductive in the observed population. The observed value of 43.2% was only 65% of the expected value of 66.9% in a stable population. As a result, recruitment rates were low during the study such that the proportion of juveniles remained low and their mean age increased until about 1984, at which time females born after the live-capture fishery began to mature.

The back-projections (Fig. 26b) indicate that the southern community was increasing during 1960–65, which was prior to the live-capture fishery. However, the community could not sustain the large croppings during 1967–71 and by 1971 was reduced to 67 individuals, 70% of its 1967 peak size of 96 individuals. Overall, between

1960–74, the population showed little net change in size ($\lambda=0.994$). During this period, the community was cropped at a weighted mean rate of 4.10%, or about 1.44 times the non-selective sustainable take. The reason the community did not decline more sharply was that the cropped animals were mainly juveniles and males. As noted above, the impact of the removal of juvenile females was pro-rated over future years (i.e. had they not been cropped they would have been contributing to recruitment during the study). Also, the removal of males had no direct demographic impact on the population.

In summary, the recovery of the southern community from the live-capture fishery was hindered by several factors: (1) a disproportionate number of females became post-reproductive just prior to or early in the study – this may have been unrelated to the live-capture fishery, or been an indirect effect due to the reduction in the prevalence of mature males as a result of the fishery; (2) because of the cropping of juvenile females, fewer females than expected matured during the study to replace those that became post-reproductive; (3) one female (K40) remained unproductive to age 22.5 years; (4) juveniles experienced slightly higher mortality than expected (Section 4.1.2). The first three factors accounted for an estimated shortfall in recruitment of 4.1, 8.9 and 2.2 calves during the study, respectively. The fourth factor accounted for 2.6 more juvenile deaths than expected. If these figures are added to observed rate of increase of 1.30%, the net increase would have been 2.81%, or 96% of the expected rate of 2.92%.

4.4 Stationary population (at carrying capacity)

A population cannot continue to increase indefinitely and, as it approaches its carrying capacity, births and deaths must attain an equilibrium. A stable population that is neither increasing or decreasing in size is said to be stationary. Since we found no direct evidence of density dependence in the killer whale life history parameters (Section 3.7), we examined the sensitivity of the population to changes in each parameter. Based on the sensitivity analysis, we speculate as to how density dependence would most likely be expressed and how the sex- and age-structure would be affected by such changes.

4.4.1 Sensitivity analysis

Animal populations are regulated by changes in female birth and death rates which can be broadly categorized as follows:

- | | |
|---|--|
| (1) Birth rates | Parameter: |
| (i) Fecundity rates | $FEC_{r(x)} = FER_{r(x)} \cdot SV_{(0.5)}$ |
| (ii) Age at first birth | $MAT_{f(x)}$ |
| (iii) Age at onset of post-reproduction | $PR_{(x)}$ |
| (2) Death rates | |
| (i) Juvenile mortality | $MR_{s(x)}$ for $0.5 \geq x \geq 14.5$ |
| (ii) Adult mortality | $MR_{s(x)}$ for $x \geq 15.5$ |

Note that changes in fecundity may reflect either changes in the fertility (pregnancy) rate or the neonate survival rate. Since the effect of change in either of these parameters was identical (e.g. doubling the fertility rate was equivalent to doubling the neonate survival rate) only the sensitivity to net changes in fecundity was examined.

The relative sensitivity of the population to changes in each parameter was assessed with the matrix model by varying the transition probabilities in the projection matrix, M , and recalculating the stable rate of population growth, λ , and the stable sex- and age-structure, n_s , using equations (43) and (42). Changes in fecundity and mortality rates were effected by simply multiplying the current estimates of the parameters by an appropriate factor. For example, the effect of a 2-fold increase in fecundity was assessed by multiplying the top two rows of the transition matrix, M , by 2. Because the mortality rates of females aged 15.5–24.5 years were below detectable limits (Table 12), the weighted mean mortality rate for ages 15.5–34.5 years was used. This tends to slightly exaggerate the sensitivity of the population to changes in adult mortality rates. Changes in $MAT_{f(x)}$ and $PR_{(x)}$ were effected by shifting the curves shown in Figs 7 and 17 by the appropriate number of years to the left or right.

The sensitivity analysis indicated that λ , was surprisingly insensitive to changes in life history parameters (Fig. 27). For example, a stationary population ($\lambda=1$) could only be obtained by either:

- (1) reducing $FEC_{r(x)}$ to 50% of the current values;
- (2) increasing mean age at first birth from 15 to 30 years;
- (3) decreasing mean age at last birth from 40 to 24 years;
- (4) increasing juvenile mortality rates by a factor of 3.8;
- (5) increasing adult mortality rates by a factor of 50.

The stationary sex- and age-structures corresponding to each of the above changes are summarized in Fig. 28.

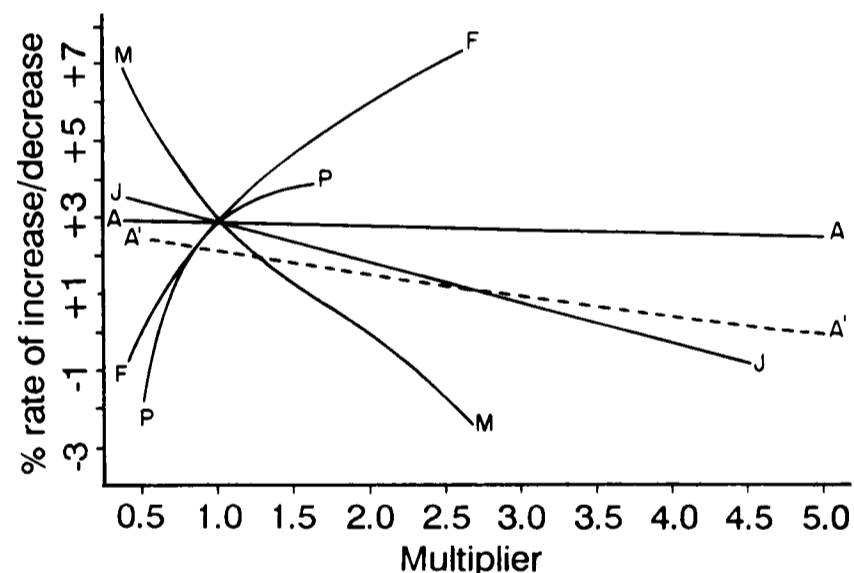

Fig. 27. Sensitivity of the population growth rate, λ , to relative changes in each life history parameter (F=fecundity rate; M=mean age at first birth; P=mean age at onset of reproductive senescence; J=juvenile mortality rate; A=adult mortality rate; and A'= adult mortality at 10-times the scale indicated on the horizontal axis). For example, the value of λ at 2.5 represents the finite rate of population growth resulting from a 2.5-fold increase in each parameter (solid lines) or a 25-fold increase in adult mortality rates (dashed line).

The population growth rate, λ , was generally more sensitive to changes in reproductive parameters (Fig. 27 – F, M and P) than mortality rates (Fig. 27 – J, A, and A'). The effects of changes in the reproductive parameters were non-linear. For example, increasing $FEC_{r(x)}$ had less of an effect than decreasing $FEC_{r(x)}$ (Fig. 27 – F). This was because a decrease in $FEC_{r(x)}$ skewed the age-composition toward older mature animals (Fig. 28 – F) such that more animals were affected by the change. In contrast, the sensitivity of λ to changes in $MAT_{f(x)}$ was more pronounced as $MAT_{f(x)}$ was both increased and decreased (Fig. 27 – M). This was because a decrease in $MAT_{f(x)}$ skewed the age-composition toward young animals such that progressively more were affected by the decrease.

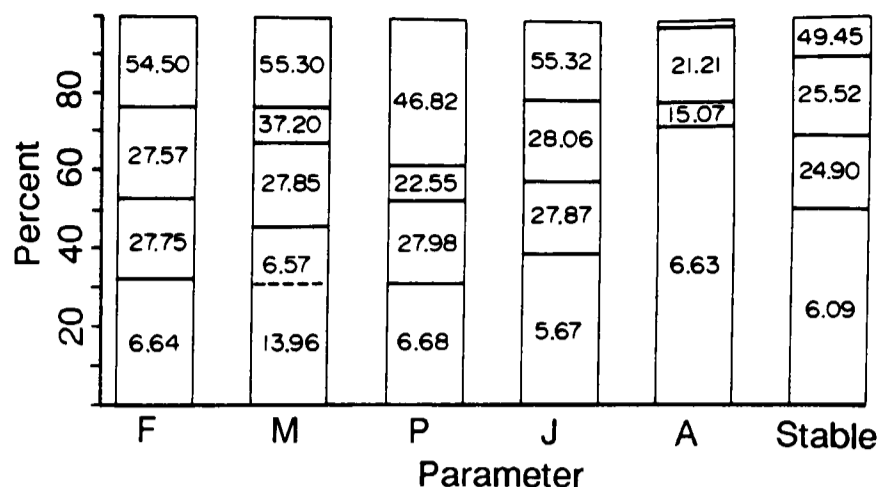

Fig. 28. The stable sex- and age- structure for the stationary populations ($\lambda=1$) corresponding to the change in each of the life history parameters required to balance the population. The populations are partitioned into, from bottom to top: juveniles, mature males, reproductive females and post-reproductive females. The numbers within each partition represent the mean age of animals within each category. Note that for M, only the mean age at maturation of females was adjusted; the disparate sex ratio of juveniles is indicated by the dashed line: females (bottom) and males (top).

However, large increases in $MAT_{f(x)}$ also had a pronounced effect because females began to become post-reproductive before they gave birth to their first viable calves (Fig. 28 – M). Decreasing $PR_{(x)}$ had a far greater effect than increasing $PR_{(x)}$ (Fig. 27 – P) for the same reasons outlined above for $FEC_{r(x)}$ (Fig 28 – P).

The stationary sex- and age-structure resulting from a change in either of the reproductive parameters, or for that matter any combination of the reproductive parameters, is identical to that shown in Fig. 20. However, the ages at which females are categorized as juvenile, reproductive and post-reproductive differs depending on which of the reproductive parameters are varied. The age-structure is the same because mortality rates had not been altered so that the decline in cohort size with age was not affected. Also, by definition, the initial size of cohorts remains constant over time in a stationary population.

The population was less sensitive to changes in juvenile mortality rates than to changes in the reproductive parameters. The effect of a change in juvenile mortality rates was nearly linear and not as pronounced as might be expected (Fig. 27 – J). This was because an increase in juvenile mortality skewed the population toward older age-classes (Fig. 28 – J) so that fewer animals were affected by the change and vice versa. The sex- and age-structure of the stationary population resulting from a 3.8-fold increase in juvenile mortality was intermediate to those shown in Figs 20 and 22. The juvenile component of the stationary population resembled the latter whereas the mature component was identical to the former.

The population was extremely robust to changes in adult mortality rates (Fig. 27 – A and A'). The stationary population corresponding to a 50-fold increase in the adult mortality rate was grossly skewed toward juveniles and essentially devoid of post-reproductive females (Fig. 28 – A). The robustness could be attributed to the fact that reproductive females contributed most to recruitment early in their reproductive lifespan (i.e. they had to die early in their reproductive lifespan to have much of an effect) and the mortality rates of reproductive females were extremely low.

Contrary to the above, it has been widely cited that populations of large mammals are very sensitive to changes in adult mortality rates. This is in fact a misinterpretation

of work by Eberhardt and Siniff (1977), Breiwick, Eberhardt and Braham (1984), Goodman (1984) and others that has actually shown that large-mammal populations are sensitive to changes in adult survival rates, which does not imply equal sensitivity to mortality rates. For example, female killer whales aged 15.5–34.5 years had a mean finite mortality rate of 0.0020 and survival rate of 0.9980. Thus, a 50-fold increase in mortality to 0.0992 represented less than a 10% reduction in the survival rate. Thus, like other large-mammal populations, killer whale populations are very insensitive to relative changes in mortality rates, but sensitive to relative changes in survival rates.

4.4.2 Stationary population parameters

The sensitivity analysis suggests that: (1) density dependence is more likely to be expressed through changes in reproductive rates rather than mortality rates, especially adult mortality rates; and (2) the magnitude of changes in any single life history parameter, with the exception of perhaps $FEC_{r(x)}$, required to balance the population are unrealistic. Thus, density dependence is probably expressed by simultaneous changes in several life history parameters.

The most objective estimate of the sex- and age-structure of a stationary killer whale population was obtained by changing each life history parameter an equal relative amount. Iteratively, it was found that a 20% change in each parameter was required to balance the population. That is, $FEC_{r(x)}$ s were set at 80% of their estimated values, mean age at first birth was increased from 15 to 18 years, mean age at onset of post-reproduction was reduced from 40 to 32 years and mortality rates for all age-classes were set at 120% of their estimated values. The resulting stationary population comprised 36.6% juveniles (54.7% female and 45.3% male with mean ages of 8.1 and 6.5 years, respectively; the skewed ratio resulted because age of maturation of males was not adjusted), 19.8% males (mean age 26.6 years), 14.4% reproductive females (mean age 26.7 years) and 29.0% post-reproductive females (mean age 49.4 years). Selected population parameters for the stationary population are summarized in Table 17 and condensed life tables are given in Appendix 1.

The predicted stationary population probably provides a fairly accurate representation of an actual stationary population. This is because density dependence is likely to

Table 17

Comparison of select population parameters for a stable population that is below carrying capacity and increasing at its intrinsic rate and population parameters for a stationary population at carrying capacity.

Life history parameter:	Stable:	Stationary:
<i>Life expectancy:</i>		
Male at age 0.5years	50.1 yrs	45.9 yrs
Female at age 0.5years	28.7 yrs	26.0 yrs
<i>Survival:</i>		
Both sexes to maturation (age)	77.9% (15.5)	74.1% (18.5)
Female to post-reproduction (age)	71.2% (40.5)	71.9% (32.5)
Male to physical maturity (age 21.5)	72.2%	67.6%
<i>Net reproductive rate</i>		
(number of male and female calves)	4.08 calves	2.00 calves
<i>Sex ratio (females:males)</i>	1.30:1	1.76:1
<i>Finite rates:</i>		
Total death, <i>per capita</i>	0.02180	0.02778
Total birth, <i>per capita</i>	0.05103	0.02772
Population increase	2.92%	0.01%

be expressed primarily through changes in reproductive parameters and the manner in which the reproductive parameters varied had no effect on the sex- and age-structure of the population. Moreover, an increase in juvenile mortality rates and a decrease in the reproductive rates has similar effects on the sex- and age-structure. Thus, serious inaccuracies will arise only if adult mortality plays a more important role in density dependence than we have predicted.

It is worth noting that the magnitude of changes in the life history parameters required to balance the population fall well outside the confidence limits of the parameter estimates in the present study. We therefore anticipate that continued monitoring of killer whales in the coastal waters of British Columbia and Washington State as they ultimately approach their carrying capacity will refine our understanding of the mechanisms of population regulation in this species.

ACKNOWLEDGEMENTS

We are especially grateful to K.C. Balcomb, and J.K.B. Ford whose contributions to the killer whale study over the years were instrumental to our analysis. Many other researchers and volunteers provided valuable photographs and observations or reported whale sightings. P.F.O extends special thanks to A.N. Arnason for having instilled the quantitative background necessary to undertake this analysis. E. Warnerbodt drafted the figures. D.E. Bain, J.K.B. Ford, A.E. York and two anonymous reviewers made useful comments on earlier drafts of the manuscript.

REFERENCES

Anderson, G.R.V. 1982. A re-examination of pregnancy rates and calf ratios in *Orcinus orca*. Appendix 5. Report of the Workshop on Identity, Structure and Vital Rates of Killer Whale Populations, Cambridge, England, June 23–25, 1981. *Rep. int. Whal. Commn* 32: 629–31.

Bain, D.E. 1990. Testing the validity of inferences drawn from photo-identification data, with special reference to the studies of the killer whales (*Orcinus orca*) in British Columbia. Paper SC/A88/ID33 (published in this volume).

Baird, R.W. and Stacey, P.J. 1988. Variation in saddle patch pigmentation in populations of killer whales (*Orcinus orca*) from British Columbia, Alaska and Washington State. *Can. J. Zool.* 66: 2582–5.

Balcomb, K.C. III, Boran, J.R. and Heimlich, S.L. 1982. Killer whales in greater Puget Sound. *Rep. int. Whal. Commn* 32: 681–6.

Bigg, M.A. and Wolman, A.A. 1975. Live-capture killer whale (*Orcinus orca*) fishery, British Columbia and Washington, 1962–73. *J. Fish. Res. Bd Can.* 32: 1213–21.

Bigg, M.A. 1982. An assessment of killer whale (*Orcinus orca*) stocks off Vancouver Island, British Columbia. *Rep. int. Whal. Commn* 32: 655–66.

Bigg, M.A., Ford, J.K.B. and Ellis, G.M. 1985. Two sympatric forms of killer whales off British Columbia and Washington. Abstract. Presented to the Sixth Conference on the Biology of Marine Mammals, Vancouver, Canada, November 1985 (unpublished).

Bigg, M.A., Ellis, G.M, Ford J.K.B. and Balcomb, K.C. 1987. *Killer Whales. A Study of Their Identification, Genealogy & Natural History in British Columbia and Washington State*. Phantom Press, Nanaimo, British Columbia 79pp.

Bigg, M.A., Olesiuk, P.F, Ellis, G.M., Ford, J.K.B. and Balcomb, K.C., III. 1990. Social organization and genealogy of resident killer whales (*Orcinus orca*) in the coastal waters of British Columbia and Washington State. Paper SC/A88/ID39 (published in this volume).

Boveng, P. 1988. Status of Pacific harbor seal population on the U.S. west coast. Admin. Rep. LJ-88–06, Southwest Fish. Center, Natl. Mar. Fish. Serv. 43 pp.

- Breiwick, J.M., Eberhardt, L.L. and Braham, H.W. 1984. Population dynamics of western Arctic bowhead whales (*Balaena mysticetus*). *Can. J. Fish. Aquat. Sci.* 41: 484-96.
- Caldwell, D.K. and D.H. Brown. 1964. Tooth wear as a correlate of described feeding behavior by the killer whale, with notes on a captive specimen. *Bull. Southern Calif. Acad. Sci.*, 63: 128-40.
- Carl, G.C. 1946. A school of killer whales stranded at Estevan Point, Vancouver Island. *Rept. Prov. Museum Natural History and Anthropol.* pp. B21-8.
- Caughley, G. 1966. Mortality patterns in mammals. *Ecology* 47: 906-18.
- Cavanagh-Ford, D. 1984. Culture and nature on the Northwest Coast. *Waters (J. Vanc. Publ. Aquarium)* 7: 6-14.
- Christensen, I. 1982. Killer whales in Norwegian coastal waters. *Rep. int. Whal. Commn* 32: 633-41.
- Christensen, I. 1984. Growth and reproduction of killer whales, *Orcinus orca*, in Norwegian coastal waters. *Rep. int. Whal. Commn* (special issue 6): 253-8.
- Cole, L.C. 1954. The population consequences of life history phenomena. *Quarterly Rev. Biol.* 29: 103-37.
- DeMaster, D.P. 1978. Calculation of the average age of sexual maturity in marine mammals. *J. Fish. Res. Bd Can.* 35: 912-15.
- DeMaster, D.P. 1981. Estimating the average age of first birth in marine mammals. *Can. J. Fish. Aquat. Sci.* 38: 237-9.
- DeMaster, D.P. 1984. Review of techniques used to estimate the average age at attainment of sexual maturity in marine mammals. *Rep. int. Whal. Commn* (special issue 6): 175-9.
- DeMaster, D.P. and Drevenak, J.K. 1988. Survivorship patterns in three species of captive cetaceans. *Mar. Mammal Sci.* 4: 297-311.
- DeMaster, D.P., Miller, D.J., Goodman, D., DeLong, R.L., and Stewart, B.S. 1982. Assessment of California sea lion fishery interactions. In: Transactions of the 47th North American Wildlife and Natural Resource Conf., 1982. Wildlife Management Institute, Washington, D.C.
- Duffield, D.A. and Miller, K.W. 1988. Demographic features of killer whales in oceanaria in the United States and Canada. *Rit. Fisk* 11:297-306.
- Eberhardt, L.L. and Siniff, D.B. 1977. Population dynamics and marine mammal management policies. *J. Fish. Res. Bd Can.* 34: 183-90.
- Emery, M. 1960. Mystery of Von Dunlop Lagoon. Did killer whales commit suicide? Victoria Daily Colonist, Victoria, British Columbia. 3 pp.
- Evans, P.G.H. 1988. Killer whales (*Orcinus orca*) in British and Irish waters. *Rit. Fisk* 11:42-54.
- Fisher, R.A. 1929. *The Genetical Theory of Natural Selection*, 2nd rev. ed. Dover, New York.
- Fowler, C.W. 1984. Density dependence in cetacean populations. *Rep. int. Whal. Commn* (special issue 6): 373-9.
- Fowler, C.W. 1987. A review of density dependence in populations of large mammals. Chapter 10. In: H.H. Genoways (ed.). *Current Mammalogy, Vol. 1*. Plenum Publ.
- Gambell, R. 1972. Sperm whales off Durban. *Discovery Rep.* 35: 199-358.
- Goodman, D. Statistics of reproductive rate estimates, and their implication for population projection. *Rep. int. Whal. Commn* (special issue 6): 161-74.
- Heimlich-Boran, J.R. 1988. Behavioural ecology of killer whales (*Orcinus orca*) in the Pacific Northwest. *Can. J. Zool.* 66: 565-78.
- Heyning, J.E. 1988. Presence of solid food in a young killer whale (*Orcinus orca*). *Mar. Mammal Sci.* 4: 68-71.
- Hoyt, E. 1981. *The Whale Called Killer*. E.P. Dutton, New York.
- International Whaling Commission. 1980. Report of the Workshop. *Rep. int. Whal. Commn* (special issue 3): 1-50.
- International Whaling Commission. 1982. Report of the Workshop on Identity, Structure and Vital Rates of Killer Whale Populations, Cambridge, England. *Rep. int. Whal. Commn* 32: 617-31.
- International Whaling Commission. 1984. Report of the Workshop. *Rep. int. Whal. Commn* (special issue 6): 1-24.
- Jacobsen, J.K. 1980. The birth of a wild killer whale (*Orcinus orca*). Orca Symposium, the biology and behavior of the killer whale (*Orcinus orca*). Held at Kane Hall, Univ. Washington, 10-12 October 1980, Am. Cet. Soc. and College of Fisheries, Univ. of Washington, Washington. Abstract.
- Jonggård, A. and Lyshoel, P.B. 1970. A contribution to the knowledge of the biology of the killer whale *Orcinus orca* (L.). *Nytt magasin for Zoologi*: 41-8.
- Kasuya, T. and Marsh, H. 1984. Life history and reproductive biology of the short-finned pilot whale, *Globicephala macrorhynchus*, off the Pacific coast of Japan. *Rep. int. Whal. Commn* (special issue 6): 259-310.
- Kasuya, T., Sergeant, D.E. and Tanaka, K. 1988. Re-examination of life history parameters of long-finned pilot whales in the Newfoundland waters. *Sci. Rep. Whales Res. Inst., Tokyo.* 39: 103-19.
- Leatherwood, S., Balcomb, K.C., Matkin, C.O. and Ellis, G. 1984. Killer whales (*Orcinus orca*) of southern Alaska. Results of field research. Preliminary report. HSWRI Tech. Rept. No. 84-175. 59 pp.
- Leslie, P.H. 1945. On the use of matrices in certain population mathematics. *Biometrika* 35: 183-212.
- Lewis, E.G. 1942. On the generation and growth of a population. *Sankhya* 6: 93-96.
- Lotka, A.J. 1907a. Relation between birth rates and death rates. *Science* 26: 21-2
- Lotka, A.J. 1907b. Studies on the mode of growth of material aggregates. *Amer. J. Sci.* 24: 119-216.
- Marsh, H. and Kasuya, T. 1986. Evidence for reproductive senescence in female cetaceans. *Rep. int. Whal. Commn* (special issue 8): 57-74.
- Matkin, C.O., Ellis, G., von Ziegler, O., and Steiner, R. 1986. Killer whales and longline fisheries in Prince William Sound, Alaska. Report No. 40ABNF6 2262 to Northwest and Alaska Fisheries Center, National Marine Mammals Laboratory, Seattle, Wash. 15 pp.
- Mikhalev, Y.A., Ivashin, M.V., Savusin V.P., and Zelenya, F.E. 1981. The distribution and biology of killer whales in the Southern Hemisphere. *Rep. int. Whal. Commn* 31: 551-66.
- Mitchell, E.D.(ed.) 1975. Review of biology and fisheries for small cetaceans. *J. Fish. Res. Bd Can.* 32: 889-983.
- Mitchell, E.D. and Baker, A.N. 1980. Age of reputedly old killer whale, *Orcinus orca*, 'Old Tom' from Eden, Twofold Bay, Australia. *Rep. int. Whal. Commn* (special issue 3): 143-54.
- Morton, A.B. 1990. A quantitative comparison of behaviour in resident and transient killer whales of the central British Columbia coast. Paper SC/A88/P17 (published in this volume).
- Myrick, A.C., Yochem, P.K., and Cornell, L.H. 1988. Toward calibrating dentinal layers in captive killer whales by use of tetracycline labels. *Rit. Fisk* 11:285-96.
- Neter, J. and Wasserman, W. 1984. *Applied Linear Statistical Models*. Richard D. Erwin, Inc., Illinois.
- Nishiwaki, M. and Handa, C. 1958. Killer whales caught in the coastal waters off Japan for recent 10 years. *Sci. Rep. Whales Res. Inst., Tokyo.* 13: 85-96.
- Pike, G.C. and MacAskie, I.B. 1969. Marine mammals of British Columbia. *Fish. Res. Bd Can. Bull.* 71. 54 pp.
- Sacher, G.A. 1980. The constitutional basis for longevity in the Cetacea: Do the whales and terrestrial mammals obey the same laws? *Rep. int. Whal. Commn* (special issue 3): 209-14.
- Seber, G.A.F. 1982. *The Estimation of Animal Abundance and Related Parameters*. 2nd Edn. Griffin, London. 645 pp.
- Sergeant, D.E. 1962. The biology of the pilot or pothead whale *Globicephala melaena* (Traill) in Newfoundland waters. *Fish. Res. Bd Can. Bull.* 132. 84 pp.
- Snedecor, G.W. and Cochran, W.G. 1980. *Statistical Methods (7th edition)*. The Iowa State Univ. Press, Iowa.
- Sumich, J.L. and Harvey, J.T. 1986. Juvenile mortality in gray whales (*Eschrichtius robustus*). *J. Mamm.* 67: 179-82.
- Swartz, S.L. and Jones, M.L. 1983. Gray whale (*Eschrichtius robustus*) calf production and mortality in the winter range. *Rep. int. Whal. Commn* 34: 503-7.
- Sweeney, J.C. 1977. Difficult births and neonatal health problems in small cetaceans. In: S.H. Ridgway and K. Benirschke (eds.). *Breeding Dolphins; Present Status, Suggestions for the Future*. U.S. Dept. Comm. N.T.I.S. PB-273 673 for Marine Mammal Commission, Washington, D.C. 308 pp.
- Tanami, R. 1984. A killer whale legacy. *Waters (J. Vanc. Publ. Aquarium)* 7: 15-20.
- Usher, M.B. 1972. Developments in the Leslie Matrix Model. pp 29-60 In: J.N.R. Jeffers (ed.). *Mathematical Models in Biology*. Blackwell, Oxford.
- Walker, L.A., Cornell, L., Dahl, K.D., Czckala, N.M., Dargen, C.M., Joseph, B., Hsueh, A.J.W. and Lasley, B.L. 1988. Urinary concentrations of ovarian steroid hormone metabolites and bioactive follicle-stimulating hormone in killer whales (*Orcinus orca*) during ovarian cycles and pregnancy. *Biol. Reprod.* 39: 1013-20.

Appendix 1

B. Males

Predicted condensed life tables for a stationary population at carrying capacity.

A. Females

x	$L_{(x)}$	$d_{(x)}$	$q_{(x)}$	$l_{(x+0.5)}$	$e_{(x)}$	$m_{(x)}$	$P_{(x)}$
0.5	1000.0	48.5	0.0485	975.4	45.9	0.0000	1000.0
1.5	951.5	28.8	0.0303	937.0	47.3	0.0000	951.4
2.5	922.7	27.9	0.0303	908.8	47.7	0.0000	922.6
3.5	894.7	23.5	0.0263	882.9	48.2	0.0000	894.6
4.5	871.2	22.9	0.0263	859.6	48.5	0.0000	871.0
5.5	848.3	22.3	0.0263	837.0	48.8	0.0000	848.0
6.5	825.9	15.5	0.0188	818.1	49.1	0.0000	825.7
7.5	810.4	15.2	0.0188	802.8	49.0	0.0000	810.1
8.5	795.2	15.0	0.0188	787.7	49.0	0.0000	794.8
9.5	780.2	14.7	0.0188	772.8	48.9	0.0000	779.8
10.5	765.5	5.1	0.0066	763.0	48.8	0.0000	765.1
11.5	760.5	5.0	0.0066	758.0	48.1	0.0000	760.0
12.5	755.5	5.0	0.0066	753.0	47.4	0.0000	755.0
13.5	750.5	5.0	0.0066	748.0	46.8	0.0000	750.0
14.5	745.6	5.0	0.0066	743.1	46.1	0.0000	745.0
15.5	740.6	0.0	0.0000	740.6	45.4	0.0489	740.0
16.5	740.6	0.0	0.0000	740.6	44.4	0.0460	740.0
17.5	740.6	0.0	0.0000	740.6	43.4	0.0955	739.9
18.5	740.6	0.0	0.0000	740.6	42.4	0.0813	739.9
19.5	740.6	0.0	0.0000	740.6	41.4	0.0838	739.9
20.5	740.6	0.0	0.0000	740.6	40.4	0.0626	739.8
25.5	740.6	3.2	0.0043	739.1	35.4	0.0694	739.6
30.5	725.0	3.1	0.0043	723.4	31.1	0.0456	723.7
35.5	709.6	9.3	0.0130	705.0	26.7	0.0236	708.2
40.5	664.5	8.7	0.0130	660.2	23.3	0.0104	663.0
45.5	622.3	18.7	0.0300	612.9	19.8	0.0039	620.7
50.5	534.4	16.0	0.0300	526.3	17.6	0.0014	532.9
55.5	458.9	18.1	0.0393	449.8	15.1	0.0005	457.5
60.5	375.5	14.8	0.0393	368.0	12.9	0.0000	374.2
65.5	307.2	25.4	0.0828	294.2	10.2	0.0000	306.1
70.5	199.4	16.5	0.0828	191.0	9.5	0.0000	198.7
75.5	129.5	10.7	0.0828	124.0	8.4	0.0000	129.0
80.5	84.1	7.0	0.0828	80.5	6.7	0.0000	83.7
85.5	54.6	4.5	0.0828	52.3	4.1	0.0000	54.3
90.5	35.4	35.4	1.0000	17.7	0.5	0.0000	35.3

x	$L_{(x)}$	$d_{(x)}$	$q_{(x)}$	$l_{(x+0.5)}$	$e_{(x)}$	$P_{(x)}$
0.5	1000.0	48.5	0.0485	975.4	26.0	1000.0
1.5	951.5	28.8	0.0303	937.0	26.3	951.4
2.5	922.7	27.9	0.0303	908.6	26.1	922.6
3.5	894.7	23.5	0.0263	882.9	25.9	894.6
4.5	871.2	22.9	0.0263	859.6	25.5	871.0
5.5	848.3	22.3	0.0263	837.0	25.2	848.0
6.5	825.9	15.5	0.0188	818.1	24.9	825.7
7.5	810.4	15.2	0.0188	802.8	24.4	810.1
8.5	795.2	15.0	0.0188	787.7	23.8	794.8
9.5	780.2	14.7	0.0188	772.8	23.3	779.8
10.5	765.5	5.1	0.0066	763.0	22.7	765.1
11.5	760.5	5.0	0.0066	758.0	21.8	760.0
12.5	755.5	5.0	0.0066	753.0	21.0	755.0
13.5	750.5	5.0	0.0066	748.0	20.1	750.0
14.5	745.6	4.9	0.0066	743.1	19.3	745.0
15.5	740.6	7.3	0.0098	737.0	18.4	740.0
16.5	733.4	7.2	0.0098	729.7	17.6	732.7
17.5	726.1	7.1	0.0098	722.6	16.7	725.5
18.5	719.0	7.1	0.0098	715.5	15.9	718.3
19.5	711.9	7.0	0.0098	708.4	15.0	711.2
20.5	704.9	29.4	0.0417	690.1	14.2	704.1
25.5	569.7	34.6	0.0608	552.2	12.0	568.9
30.5	416.4	35.3	0.0847	398.4	10.5	415.7
35.5	267.5	22.7	0.0847	255.9	10.1	267.0
40.5	171.9	14.6	0.0847	164.4	9.4	171.5
45.5	110.4	9.4	0.0847	105.6	8.3	110.1
50.5	70.9	6.0	0.0847	67.9	6.6	70.7
55.5	45.6	3.9	0.0847	43.6	4.0	45.4
60.5	29.3	29.3	1.0000	14.6	0.5	29.2

A Quantitative Comparison of the Behaviour of Resident and Transient Forms of the Killer Whale off the Central British Columbia Coast

Alexandra B. Morton

Raincoast Research, Simoom Sound, British Columbia, Canada, VOP 1S0

ABSTRACT

This study compares and quantifies behavioural differences between the resident and transient forms of the killer whale in inlets of British Columbia based on data collected during 1984–88 off northeastern Vancouver Island. Many behavioural differences were observed. Resident whales were seen most often in the summer-fall whereas transient occurrence peaked in the spring and the fall. Transient groups were smaller than resident groups. Transients spent more time foraging and dived for longer periods. Residents spent more time playing and resting, and were more vocal. Transients travelled more erratic routes and appeared to have less specific ranges than residents. Only transients were observed eating warm-blooded prey. The two races were not seen to mix but were observed to avoid each other. Some behavioural differences can be related to contrasting hunting strategies utilized by transients for marine mammal predation and by residents for fish predation.

INTRODUCTION

The occurrence of two races of killer whales (*Orcinus orca*), residents and transients, in British Columbia was first proposed by Bigg (1982) and has now been confirmed by others (e.g. Jacobsen, 1986; Osborne, 1986; Heimlich-Boran, 1986; Bigg, Ellis, Ford and Balcomb, 1987; Baird and Stacey, 1988a, 1988b). The resident race is divided into northern and southern communities (Bigg, Olesiuk, Ellis, Ford and Balcomb, 1990) with geographically separate ranges. However, the transient race appears to form one community that extends from southeastern Alaska to Washington State, including the Queen Charlotte Islands. The two races exist within the same range, but do not appear to mix. They can be characterized by differences in appearance of their dorsal fins and saddle patches and by many aspects of behaviour. Transients comprise about 25% of the total killer whale population in British Columbia. Numerous behavioural differences have been reported, although not quantified. In this report, I present the results of quantitative comparisons between the two races, observed within the mainland inlets of the central British Columbia coast during 1984–88.

METHODS

From November 1984 to March 1988, a study area off northeastern Vancouver Island (Fig. 1) was monitored continuously for the presence of killer whales. A field station was established in Echo Bay where a permanent hydrophone was installed. In 1988, a microphone was installed which focused into an acoustically reflective parabolic dish to detect the blows of whales at night that were not vocalizing as they passed the field station. A signal from a second hydrophone located 6.5km away was also monitored via a low power VHF transmitter. Whales sighted from the research station contributed 11% of the encounters; 5% were detected acoustically by hydrophone; 34% were found by searching the area in a 5.1m fibreglass speedboat; and 50% were reported by local residents, fisheries vessels and tourists.

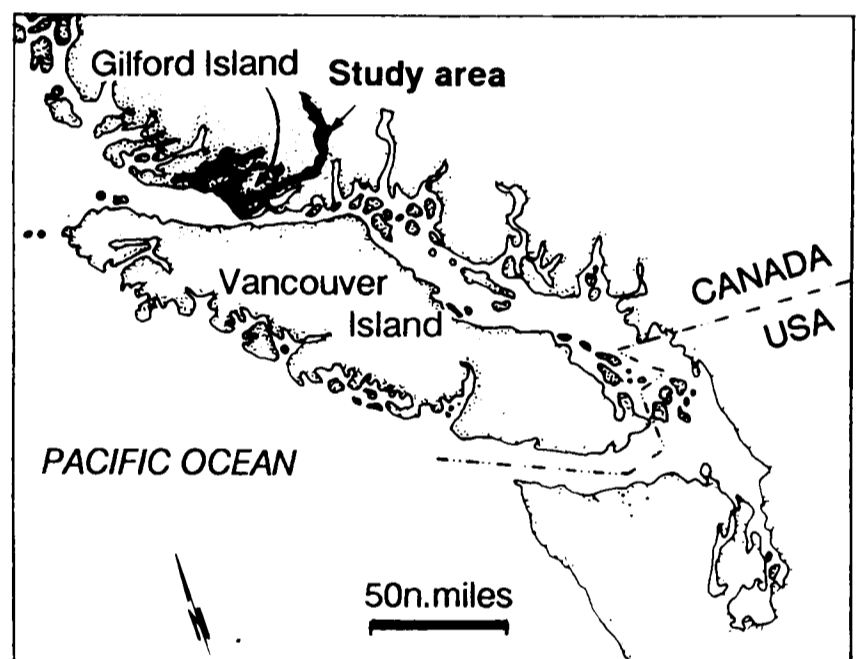

Fig. 1. Geographic location of the study area.

Field observations consisted of photo-identifying individuals, recording vocalizations and describing surface behaviour, such as spy-hopping, porpoising, milling, and the speed and positioning of individuals. Photographs for identification were taken of the whales' left sides to conform with the British Columbia killer whale catalogue (Bigg *et al.*, 1987; Bigg *et al.*, 1990). Closeups of the dorsal fin and saddle patch were taken with a 300mm lens mounted on a shoulder brace. *Ilford* HP5 film was exposed and developed at ASA 1600 to allow as high a shutter speed as possible (preferably 1/4000sec). Sightings and photographs were also collected by the public. The identification of each whale from photographs was confirmed by M. Bigg and G. Ellis, Pacific Biological Station, Nanaimo, British Columbia.

To record sound production by the whales, a *Sea Acoustics* hydrophone equipped with a *Sony* TC-DM5 cassette recorder was deployed from the boat approximately 1.8km ahead of the whales. A microphone feed into the tape recorder was used to tape verbal field observations. A digital stopwatch was used to collect data on dive durations.

The statistical significance of behavioural differences was evaluated using chi-squared and Student's *t*-tests. For the latter, equality of sample variances was tested using a folded *F*-statistic (Steele and Torrie, 1980). When necessary, *t*-statistics were adjusted to account for unequal sample variances using Satterthwaite's (1946) approximation.

RESULTS

During the study, 34 transient whales from 13 pods and 74 resident whales from 7 pods were observed (Table 1). Transients were observed in 39 encounters and residents in 55 encounters. The behaviour of the two forms varied in the following ways.

Table 1

Identity of transient and resident pods encountered in the study area during 1984-88, the size of each pod and the frequency of occurrence.

Transient pods			Resident pods		
Name	Size	Number of encounters	Name	Size	Number of encounters
F01	1	2	A01	15	14
M01	3	3	A04	7	17
O21	4	7	A05	12-13	13
O05	2	7	C01	8-10	1
O10	3	7	H01	6-7	1
P01	1	2	I11	11-14	2
P10	5	1	I31	5-7	3
Q01	3	3			
Q03	3	3			
Q04	2	2			
Q09	3	3			
Y01	3	2			
Z50	1	1			

Group size

The transient pods observed contained 1-5 individuals (mean=2.6), while resident pods contained 5-15 (mean=9.8) (Table 1). The total size of groups (e.g. pods, pod fragments or multi-pod associations) observed were also smaller for transients comprising 1-12 individuals (mean=4.7) compared with 3-39 individuals (mean=10.6) for residents (Fig. 2). The difference in the group sizes was highly significant ($t=4.88$; $P<0.01$).

Seasonality

Transients were sighted in all months of the year with the exception of May. The distribution of transient sightings was bimodal, with peaks in spring and fall (Fig. 3). Residents were sighted every month except February. The distribution of sightings was unimodal with a peak in late summer and fall.

Behavioural budget

The activities of the whales were divided into four categories which were defined as follows: (1) *foraging* – a distinctive travel pattern wherein the whales moved from one location to another, often milling at these locations; (2) *playing* – calves and/or adults engaged in tight milling on or near the surface with a wide variety of body orientations, chasing and splashing; (3) *resting* – whales tightly grouped, respiration synchronous, respiration pattern regular, slow movement down the centre of the

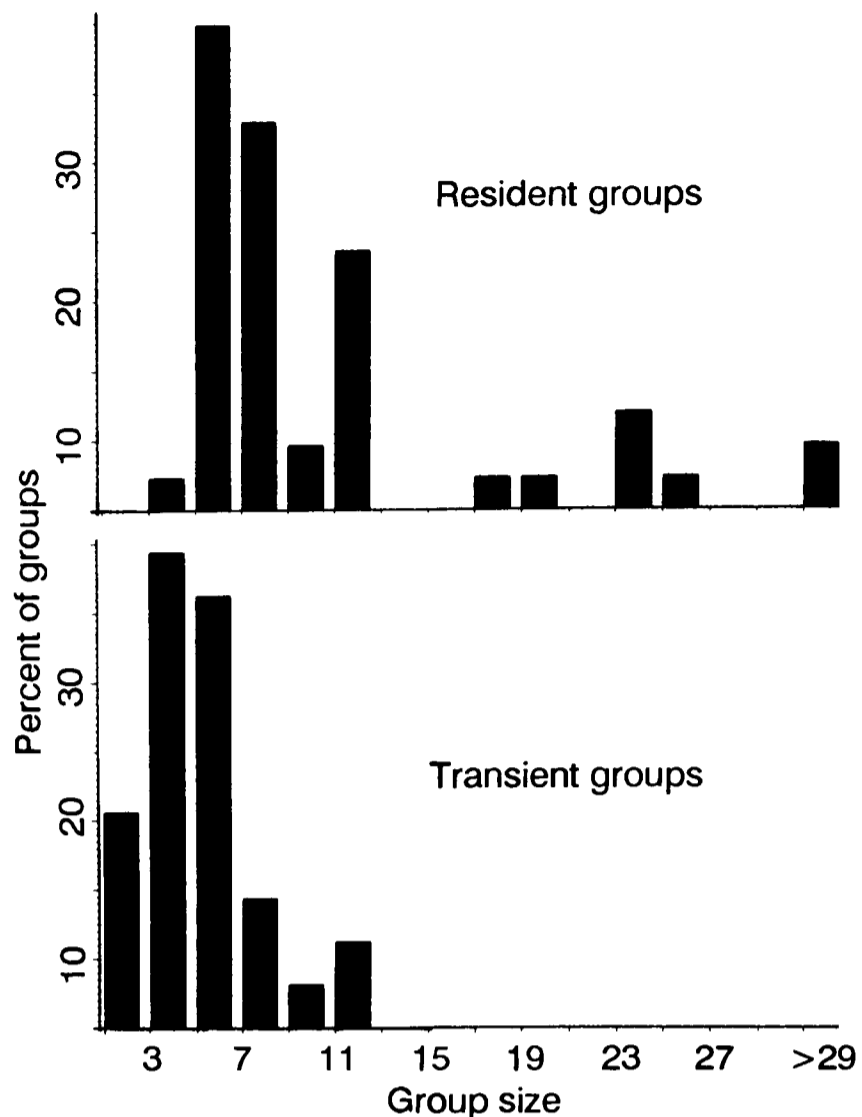

Fig. 2. The percentage of occurrences of each group size seen for transient and resident whales. A group can include part of a pod, one pod or several pods.

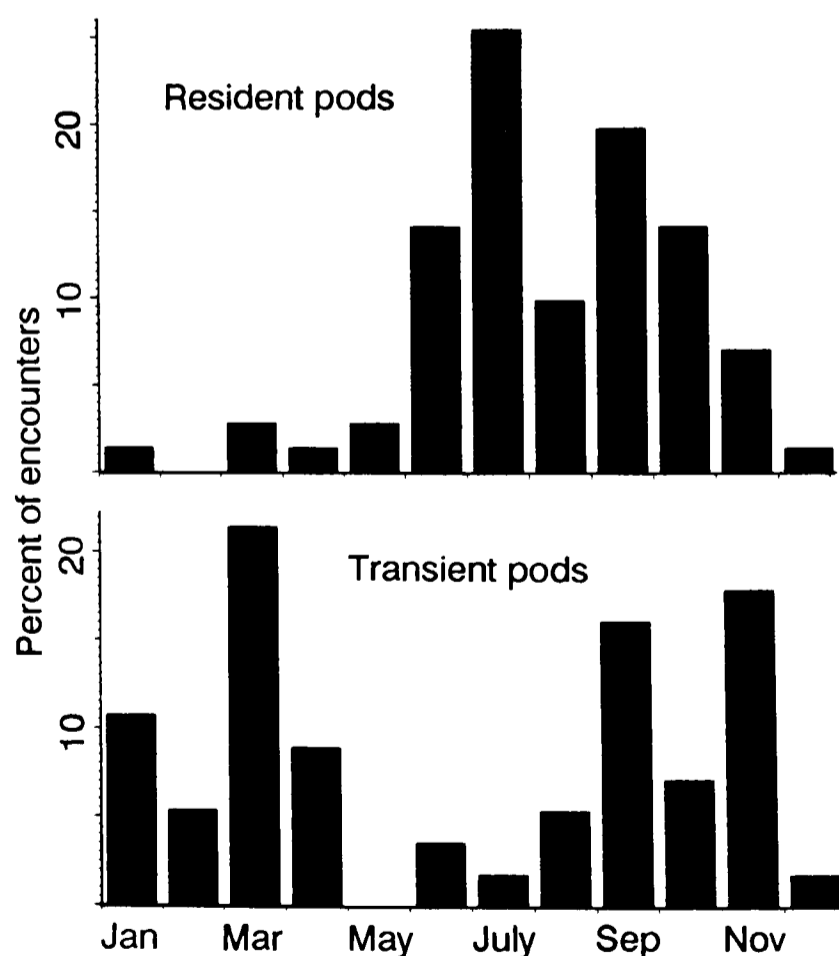

Fig. 3. The percentage of encounters of transient and resident sightings by month.

channel, sound production rare; (4) *travelling* – whales loosely grouped, some individuals close to shore and others in the centre of the channel, speed moderate to fast, bouts of vocal activity in residents and occasional spy-hops.

Table 2

Time allocation of activities by transients (101 hrs) and residents (243 hrs).

Behaviour	Transient pods	Resident pods
Forage	77%	50%
Play	8%	21%
Rest	0%	21%
Travel	15%	8%

Time allocation for various activities was different for transients and residents (Table 2). Transients spent the majority of their time foraging, while residents distributed their time more evenly over the four behavioural categories.

Dive times

When travelling and foraging, both the transient and resident killer whales typically made a sequence of several short dives followed by one long dive. Long-dive times were recorded for adult males (the most identifiable individuals) of both transient and resident races (Fig. 4). However, the respirations of all pod members were usually synchronized and thus the dive times recorded for the adult males were representative of other pod members. Transient males dived for 1.0–13.0 min (mean=6.2; SD=3.09; n=82) and resident males for 0.8–4.1 min (mean=2.8; SD=0.75; n=74). The difference in mean dive times was highly significant ($t=9.73$; $P<0.01$). Dive times of transient males also tended to be more variable (CV=0.50) than those of residents (CV=0.27).

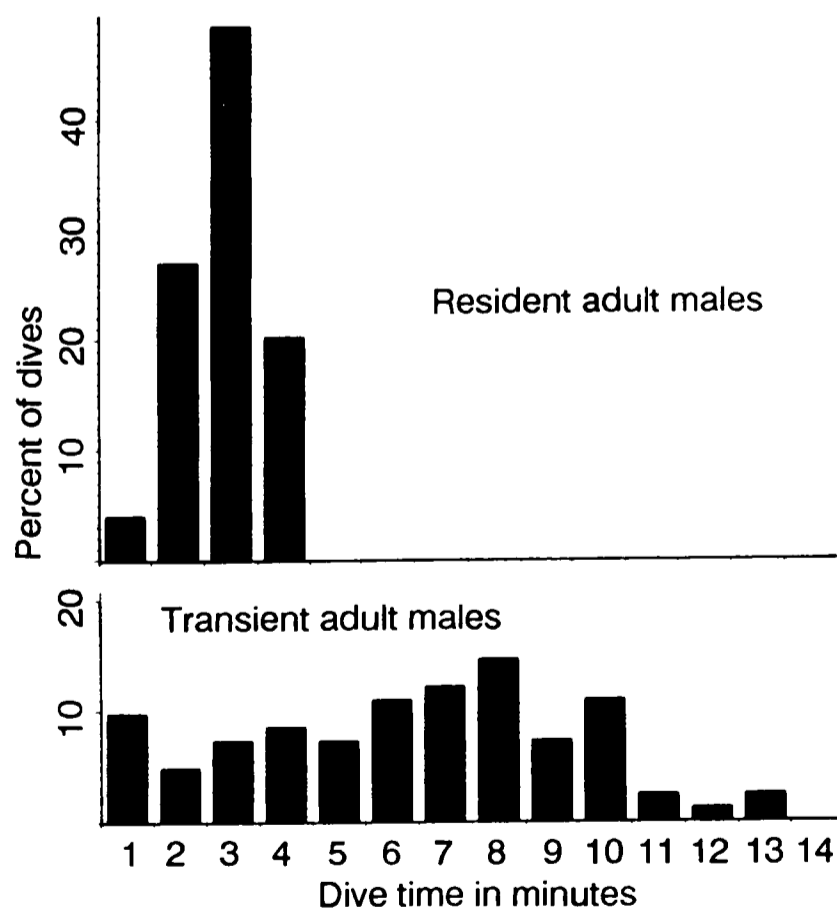

Fig. 4. The percentage of occurrence of dive times by three transient adult males (83 dives) and four resident adult males (75 dives).

Sound production

Killer whales make three kinds of sounds – calls, echolocation clicks and variable sounds. Transients made calls only during play and after a kill while the residents made calls in all behavioural states. Calls were detected in

only 15.6% of the transient encounters, but in 55.6% of the resident encounters. The difference was highly significant (chi-squared=11.5; $P<0.01$). Whenever transients were making sounds, both calls and echolocation clicks were produced together. However, when residents were making sounds they sometimes made only echolocation clicks. These latter encounters were not included in the above analyses.

Travel routes

Resident whales travelled direct routes, while transients tended to swim circuitous and often erratic routes close to shore. When travelling parallel to the coastline, resident whales generally moved from headland to headland. Transients, however, followed the contour of the shoreline to the heads of most bays and often circled small islets (Fig. 5).

During this study, killer whales were observed in 33 different areas (bays, inlets, sounds and passages). Transients entered all of these areas while residents entered only 23. The locations that were unique to transients were small bays and narrow passages.

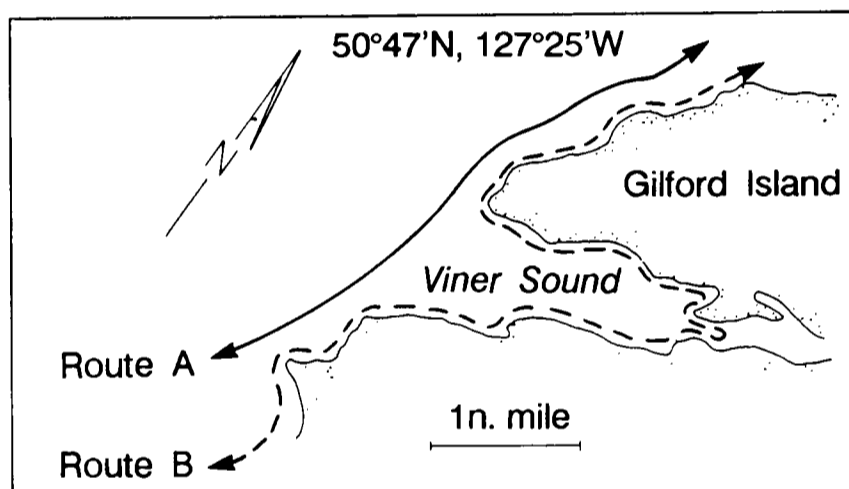

Fig. 5. Typical travel routes by transients and residents at Viner Sound, Gilford Island. Residents travelled Route A on 71% of occasions (n=14) while transients travelled Route B on 100% of occasions (n=8).

Prey species

On 14 occasions, killer whales were observed eating marine mammals or harassing mammals and marine birds. In all instances the whales involved were transients (Table 3). Residents spent time milling and apparently feeding in known holding areas for migrating salmon, while transients swam through these areas without stopping or feeding. Salmon were observed on the surface evading foraging resident whales.

Table 3

Number of marine mammals and sea birds eaten or harassed (hit, pushed, chased) by transient killer whales.

Species	Number of encounters	Transient pods	
		No. eaten	No. harassed
Harbour porpoise	5	5	0
Steller sea lion	3	3	0
Harbour seal	1	1	0
River otter	2	0	2
Dall's porpoise	1	0	1
Common loon	1	0	1
Rhinoceros auklet	1	0	1

Transient and resident interactions

Transients and residents were never observed to travel together. However, a close interaction between the two forms was observed on 10 October 1987. The transient pod O21 was travelling east in a channel and met three resident pods A01, A04 and A05 travelling west. When the transients and residents entered line of sight of each other they moved to opposite shorelines. The two groups passed within 1km of each other. Immediately after the interaction both groups spread out across the channel in a formation similar to that prior to meeting. The two forms had clearly avoided one another. On two other occasions transients entered channels where residents were vocalizing. On both occasions the transients reversed their direction and departed.

Resightings of transient and resident pods

Bigg *et al.* (1987) reported that 16 northern resident pods utilize Johnstone Strait, a region adjacent to the mainland inlets monitored during this study. However, only seven of these pods entered my study area. Of these, pods A01, A04 and A05 comprised 86% of the resident resightings (Table 1). In other areas of British Columbia, 29 transient pods have been identified; I identified 13 of them in my area. Table 1 shows that the three most frequently seen transient pods comprised only 49% of resightings and that no transient pods were resighted in much greater frequency than any others.

DISCUSSION

The results presented above show quantitative differences in behaviour between killer whales from the transient and resident races in British Columbian waters. Transients live in smaller groups, show less seasonality in occurrence, make longer dives, make fewer sounds and travel by less direct routes than residents. Transients eat mainly marine mammals rather than fish (the diet of residents) and do not mix with residents.

This paper also reveals for the first time that transients spent more time foraging than residents.

The clear difference in the natural histories of the resident and transient races of the killer whale may be related to the contrasting strategies needed to prey on either marine mammals or fish. The typical travelling and foraging patterns used by residents and transients in the inlets seem to correlate with the location of their different prey. Vocal activity may also be related to preferred prey type. By remaining silent transients do not broadcast their presence to the marine mammals they hunt. At least some

species of marine mammals have been reported to take evasive action when they hear killer whale calls (Cummings and Thompson, 1971). Fish may respond in a different way to sounds, allowing residents to be more vocally active. However, it is likely that many other factors also play a role in the differences observed in the behaviour of residents and transients.

ACKNOWLEDGMENTS

I would like to thank M. Bigg for his guidance, the information he shared, his editorial comments and his wonderful enthusiasm and P. Olesiuk for help in the statistical analysis. In addition, I would like to thank the people of the British Columbia central coast for all the radio calls that helped me locate whales.

REFERENCES

- Baird, R.W. and Stacey, P.J. 1988a. Foraging and feeding behaviour of transient killer whales. *Whalewatcher (J. Amer. Cet. Soc.)* 22:11-15.
- Baird, R.W. and Stacey, P.J. 1988b. Variation in saddle patch pigmentation in populations of killer whales (*Orcinus orca*) from British Columbia, Alaska, and Washington State. *Can. J. Zool.* 66:2582-85.
- Bigg, M.A. 1982. Assessment of killer whale, *Orcinus orca* stocks off Vancouver Island, British Columbia. *Rep. int. Whal. Commn* 32:655-66.
- Bigg, M.A., Ellis, G.E., Ford, J.K.B. and Balcomb, K.A. 1987. *Killer Whales. A Study of Their identification, Geanealogy and Natural History in British Columbia and Washington State.* Phantom Press, Nanaimo. 79pp.
- Bigg, M.A., Olesiuk, P.F., Ellis, G.M., Ford, J.K.B. and Balcomb, K.C., III. 1990. Social organisation and genealogy of resident killer whales (*Orcinus orca*) in the coastal waters of British Columbia and Washington State. Paper SC/A88/ID39 (published in this volume).
- Cummings, W.C. and Thompson, P.O. 1971. Gray whales *Eschrichtius robustus* avoid the underwater sounds of killer whales *Orcinus orca*. *Fish Bull., US* 69 (3):525-30.
- Heimlich-Boran, J.R. 1986. Fishery correlations with the occurrence of *Orcinus orca* in Greater Puget Sound, pp. 113-31. In: B.C. Kirkevold and J.S. Lockard (ed.), *The Behavioral Biology of Killer Whales.* Alan R. Liss, New York. 457pp.
- Jacobsen, J.K. 1986. The behavior of *Orcinus orca* in the Johnstone Strait, British Columbia, pp.135-85. In: B.C. Kirkevold and J.S. Lockard (ed.), *The Behavioral Biology of Killer Whales.* Alan R. Liss, New York. 457pp.
- Osborne, R.W. 1986. A behavioral budget of Puget Sound killer whales, pp. 211-49. In: B.C. Kirkevold and J.S. Lockard (ed.) *The Behavioral Biology of Killer Whales.* Alan R. Liss, New York. 457pp.
- Satterthwaite, F.E. 1976. An approximate distribution of estimates of variance components. *Biometrics Bulletin* 2:110-14.
- Steele, R.G.D. and Torrie J.M. 1980. *Principles and Procedures of Statistics, 2nd.* New York, McGraw-Hill Book Co.

Social Organisation and Population Structure of Sperm Whales off the Galápagos Islands, Ecuador (1985 and 1987)

Hal Whitehead and Susan Waters

Biology Department, Dalhousie University, Halifax, Nova Scotia, Canada B3H 4J1

ABSTRACT

During studies of sperm whales off the Galápagos Islands, Ecuador, 231 individual sperm whales were identified photographically between February and April 1985, and 395 between January and June 1987. Forty-four individuals were identified in both 1985 and 1987. The females and immatures were clustered using statistical techniques into groups with a mean estimated size of 21 individuals. Three of these groups were sighted in both years and retained much of their composition, although there was some transference between groups (estimated at 5% per year), and, within each year, a few 'transient' individuals moved between groups. The distributions of time intervals between the reidentifications of groups were consistent with either groups from a much larger Pacific population moving into and out of the Galápagos area, or groups moving into and out of the Galápagos area from a surrounding stock of about 76 groups. These models fitted the data significantly better than one assuming that sampling was from a closed population. 'Best fits' of these models suggest that there are about 15–22 groups off the Galápagos at any time, with immigration and emigration rates of about 1–3.5 groups per month. The groups of females were attended by large male sperm whales about 12–16% of the time. Large males (with estimated lengths 12.8–16.4m) formed about 2–3% of the population, although their abundance varied seasonally. Seven large males were identified in 1985 and six in 1987, but none were common to both years. The males moved between groups of females spending approximately 3–6hr with a group at one time. There were no indications of territories or preferred ranges within our study area for groups, males or transients.

INTRODUCTION

This paper examines the social organisation, population structure and population size of the sperm whale (*Physeter macrocephalus*) off the Galápagos Islands, Ecuador, using data collected during 1985 and 1987.

There has been considerable interest in the social organisation of the sperm whale both from the perspective of its functional significance (Best, 1979; Gordon, 1987; Whitehead and Arnborn, 1987) and its role in determining the population dynamics of sperm whale stocks (IWC, 1980; Best, Canham and Macleod, 1984; Whitehead, 1987). Data on living sperm whales collected off the Galápagos Islands in 1985 showed that mature male sperm whales moved between groups of females and did not hold harems as generally had been assumed (Whitehead and Arnborn, 1987). Other results of the 1985 study included the unexpectedly small number of mature males in the area, frequent associations between groups of females, and a lack of home ranges or territories for either the mature males or groups of females (Whitehead and Arnborn, 1987).

Data from a longer study in 1987 has allowed us to verify these results, as well as to examine return rates of groups of females and mature males, the stability of groups of females, and the size and stock identity of the sperm whale population in the area. During work on the 1987 data, the analysis of that from 1985 was checked and the analytical techniques were refined.

METHODS

Field research

In 1985 and 1987, research was carried out from a 10m ocean-going sloop in the waters around the Galápagos Islands, Ecuador (0°N, 91°W). We were at sea for 5–14 days at a time, and spent as much of this time as possible

tracking groups of sperm whales acoustically (Whitehead and Gordon, 1986). In 1985 we tracked sperm whales for 30 (24hr) days between 23 February and 20 April. In 1987 we tracked sperm whales for 57 days between 3 January and 28 June.

Virtually all the tracking in both years was of 'mixed' groups of whales, consisting of females with their offspring (Best, 1979), although large males were sometimes present.

Whenever possible we took photographs of the flukes of whales, in order to identify individuals (Arnborn, 1987). Photographs of dorsal fins were also taken in order to assess the presence or absence of a callus, which indicates sex (Kasuya and Ohsumi, 1966; Gordon, 1987). Photographs taken from a fixed point half way up the mast were used to estimate the lengths of individuals (Gordon, 1990; Whitehead and Arnborn, 1987).

Recordings of the whales' sounds were made for five minutes every hour and the presence of a distinctive 'slow click' was used as an indicator of the presence of large males (Weilgart and Whitehead, 1988).

Photographic identifications

Arnborn's (1987) original analysis of the photographs taken in 1985 was checked by S. Waters (a few errors were discovered), who also analysed the 1987 fluke photographs. All the identifications for both years were then checked by C. Carlson. Identifications were graded from 1 (poor) to 5 (excellent) depending on how well an individual could be recognised with certainty from the identification (Arnborn, 1987). The numbers of fluke identifications for the two years are given in Table 1.

Derivation of groups

Initially the data from each year were processed separately, using the procedure described below.

* Formerly SC/40/Sp3.

Table 1

Photographic identifications: total number of fluke identifications (with fluke quality grade), and number of individuals (number of large males in parentheses) for 1985 and 1987.

	1985	1987
<i>Total identifications</i>		
Grades 1-3	305	532
Grades 4&5	488	1,129
<i>Identified individuals (Large males)</i>		
Best photo: Grade 1-3	210(0)	135(0)
Seen 1 day (Grade 4 or 5)	150(2)	255(3)
Seen >1 day (Grade 4 or 5)	74(5)	134(3)

(1) Identifications of individuals (excluding large males) of Grade 4 or 5 were input into a computer program which produced a matrix of similarities between individuals based upon how closely in time they were photographed together (Whitehead and Arnborn, 1987).

(2) The similarity matrix obtained was used to cluster the individuals by means of an average linkage cluster analysis (Whitehead and Arnborn, 1987).

(3) Likelihood ratio tests were used to distinguish groupings of maximal size that appeared closed with no immigration or emigration (Whitehead and Arnborn, 1987).

(4) Within these groupings, 'transients-1' were identified as individuals which on two or more days were the only members of their group photographed (all identifications greater than Grade 3). Some of these were found to be obviously members of other groups which the clustering had misgrouped. These were reassigned to the correct group and no longer considered transients. The remainder appeared to be individuals which were moving between groups. They were removed from the analysis and the groupings were redefined, as in step 3 above. No 'transients-1' were found in the 1987 data.

(5) Within the new groupings, 'transients-2' were identified as individuals photographed two or more hours before or after other members of the group, but with members of other groups on at least two days (one identification greater than Grade 3). These were individuals which were probably moving between groups. 'Transients-2' were removed from the analysis, and the groupings redefined as in steps 2-3 above.

(6) 'Transients-3' were identified as individuals photographed two or more hours before or after other members of the groups, but with members of other groups, on one day (identification greater than Grade 3). These were individuals which may have been moving between groups. These were not removed from the groups.

Attributes of groups, large males and transients

Each group was given a code number, starting with 'G' for 1985 (as in Whitehead and Arnborn, 1987) and 'H' for 1987. Attributes of the 'primary' groups, those with greater than six identified individuals, are given in Tables 2-3. 'Secondary' groups, with fewer than six identified individuals may have been unidentified parts of the primary groups - some evidence for this is presented below.

Table 2

Attributes of primary groups observed in 1985: no. of identified individuals, estimated population size, no. of days identified, span of identification and associations with other groups. Only days on which more than one member of a group was identified are used in calculating the number of days identified, the time span of identifications and the associations. The last column gives the maximum number of whales visible at one time during periods when the group in question was identified but no members of other groups, or transients, were identified within 2hr.

Group	N_i	Population estimate (SE)	D>1	Time span, days	Assoc ⁿ with other groups(*)	Max ^m no. seen
G1	11	11.2 (1.1)	4	47	G2,G8	28
G2	24	35.9 (7.4)	4	13	G1	13
G3	21	22.0 (1.6)	5	24	G8(2)	33
G4	19	21.7 (2.6)	4	35	G5,G9	11
G5	16	16.3 (1.5)	4	17	G4,G8,G9	18
G6	17	24.1 (6.0)	2	41		14
G7	18	22.3 (4.4)	2	14	-	25
G8	17	22.7 (4.3)	5	36	G1,G3(2),G5	11
G9+10	17	20.7 (3.8)	3	17	G4,G5	11
G11	10		1	1	-	10
G12	9		1	1	-	26
G13	10		1	1	-	16

* The number of days pairs of groups were identified is given in parentheses if greater than one.

Population estimates, with standard errors, for the 'primary' groups were calculated by Schnabel mark-recapture techniques using days as units (Seber, 1982). Also given in Tables 2-3 are the number of individuals identified (> Grade 3) in each group, the number of days more than one individual was identified and the time span between first and last identification in days.

Table 3

Attributes of primary groups observed in 1987 (methods as in Table 2).

Group	N_i	Population estimate (SE)	D>1	Time span, days	Assoc ⁿ with other groups(*)	Max ^m no. seen
H1	17	17.2 (0.1)	4	18	H5	17
H2	15	19.6 (4.2)	3	113	-	14
H3	21	21.2 (0.2)	7	127	H4	22
H4	20	20.2 (0.9)	3	3	H3	15
H5	25	25.2 (0.2)	9	76	H1	42
H6	21	24.2 (3.2)	2	2	-	30
H7	27	79.8 (44.3)	2	2		16
H8	13	21.9 (9.3)	2	2		6
H9	10	12.4 (3.2)	2	5	H10	8
H10	11	11.1 (1.3)	2	15	H9	10
H11	11	11.2 (0.9)	2	3	H12	9
H12	42	48.6 (3.8)	4	107	H11,H13(3)	23
H13	22	22.2 (1.3)	4	4	H12(3)	21
H14	10		1	1	-	9
H15	12		1	1	-	9
H16	10		1	1	-	9
H17	9		1	1	-	11
H18	7		1	1	-	6
H19	7		1	1	-	9
H20	11		1	1	-	6
H21	15		1	1	-	10
H22	8		1	1	-	14
H23	9		1	1	-	25

* The number of days pairs of groups were identified is given in parentheses if greater than one.

Associations between groups, males and transients were defined by occasions on which individuals were identified within 2hr of one another, although other measures of association gave similar results. Associations between groups, and between particular groups and transients or males, were only considered on days when two or more members of the group were identified. This was done to reduce spurious results introduced by transients not recognised as such.

To check on the validity of the grouping analysis and the group population estimates, Tables 2 and 3 give, for each group, the maximum number of whales visible at one time during periods when the group in question was identified but no members of other groups or transients were identified within 2hr. These come from records (made every five minutes during daylight) of the position relative to the boat and behaviour of all visible whales.

Attributes of the large males and the 'transients' (estimated size, number of days identified, span of identifications and associations with groups, other large males and transients) are given in Tables 4-5. Males and transients are referred to by their identity numbers - male identity numbers are in the range 500-520.

The differences between the attributes of the primary groups and males of 1985 as presented in Tables 2 and 4 and in tables 1 and 2 of Whitehead and Arnborn (1987) are due to: the correction of a few erroneous identifications; the removal of transients-1 and transients-2; and only considering primary groups on days when more than one individual from them was identified. As a result of these changes, groups G9 and G10 (as in Whitehead and Arnborn (1987)) were merged by the clustering routine, groups were generally 'identified' on fewer days and there were fewer associations between groups.

Table 4

Attributes of males and transients (transients-1 and transients-2) observed in 1985: identification number, estimated length (using photographic technique of Gordon (1985)), no. of days identified, span of identification and associations with groups, males and transients. Only days on which more than one member of a group was identified are used in calculating the associations with groups.

ID#	Length,m	D	Time span, days	Association (*)		
				Groups	Males	Transients
<i>Males</i>						
500	15.05	3	3	G3(2)	-	-
501	16.38	3	36	G4,G5,G9	506(2)	650,348
502	14.03	1	1	G9	-	333
503	13.74	4	36	G5,G6	-	109,277
504	.	1	1	-	-	-
505	.	1	1	G13	-	-
506	14.39	2	4-		501(2)	650
<i>Transients-1</i>						
101	.	6	36	G1(3),G2,G8,G9	-	109(5),333,221(2)
109	.	5	11	G1(2),G8,G9	503	101(5),221(2)
<i>Transients-2</i>						
333	.	2	36	G1,G2,G9	502	101
650	.	2	2	G4,G8	501,506	
348	.	4	37	G3,G4,G6,G5(2),G8,G9	501	-
277	.	3	40	G5,G6(2)	503	-
221	.	2	9	G1,G8	-	101(2),109(2)

* The number of days pairs of groups/males/transients were identified is given in parentheses if greater than one.

Table 5

Attributes of males and transients (transients-2) observed in 1987. Methods as in Table 4.

ID#	Length,m	D	Time span, days	Association (*)		
				Groups	Males	Transients
<i>Males</i>						
510	12.78	3	28	H3(2),H4(2),H13	513	-
511	13.38	2	37	H6,H7	-	-
512	13.87	1	1	H13	513	-
513	12.83	3	4	H11,H12(2),H13(3)	510,512	
514	.	1	1	H12	-	-
520	.	1	1	H21	-	-
<i>Transients-2</i>						
970	.	2	46	H9,H16		-

* The number of days pairs of groups/males/transients were identified is given in parentheses if greater than one.

The position in which each group was first identified on any day (only days on which at least two members of a group were identified) was calculated from interpolation between Satellite Navigator fixes. First sighting positions for large males and transients-1 were obtained in the same manner.

Groups observed in 1985 and 1987

Forty-four individuals (but no large males) were identified in both 1985 and 1987. The number of identified individuals common to a 1985 group and a 1987 group is given in Table 6, together with the total number of identified individuals and the estimated populations of the 1985 and 1987 groups (from Tables 2-3, where possible). A population estimate (and estimated standard error) was calculated for each common group using the Petersen method (Seber, 1982).

Table 6

Individuals identified in 1985 and 1987. The number of identified individuals common to 1985 and 1987 groups is given together with the total number of individuals identified each year and the estimated population of the group (from Table 2-3, where possible). A population estimate (and estimated standard error) was calculated for each group using the Petersen method. Where the population estimates for each year, and that for the years combined, disagree, a possible explanation is offered. Finally, total identifications for the two years are combined.

No.	#	1985 Group		1987 Group		Combined population estimate		Interpretation	
		N _i	N _e	#	N _i	N _e	N		SE
1	G1	11	11.2	H6	21	24.2	-	-	Transfers between gps?
18	G2	24	35.9	H5	25	25.2	33.2	1.9	G2 loses ca10 members
4	G4	19	21.7	H20	11	-	47.0	13.0	H20=G4 plus others?
3	G7	18	22.3	H4	20	20.2	98.8	35.7	Transferring subgp?
1	G7	18	22.3	H37	1	-	-	-	Identified alone
1	G7	18	22.3	H38	1	-	-	-	Identified alone
8	G9	17	20.7	H21	15	-	31.0	4.7	H21=G9 plus others
8	G13	10		H8	13	21.9	16.1	2.2	Same group
<i>Totals:</i>									
44	All	224		All	389		1949	251	

Population size and structure

Preliminary mark-recapture population analyses suggested that it was likely that groups were entering and leaving the study area, and possibly that some groups were leaving to return later. In order to examine these possibilities, Whitehead (in press) has developed a technique for analysing mark-recapture data from an animal population in which individuals may emigrate from the study area and later return. The method allows for different capture efforts at different periods through the study. In this technique, maximum-likelihood estimates of population parameters are calculated and likelihood ratio tests are used to examine whether re-immigration is actually occurring, and, if not, whether there is any emigration or mortality. The three models of population structure below were examined.

- (1) Groups off the Galápagos are a part of a larger closed population. Within this population, a group not in the Galápagos area migrates into it with a probability μ per month, and a group in the Galápagos area migrates out of it with probability λ per month. There are at any time N groups around the Galápagos (and, it can be shown, $N \cdot (\lambda + \mu) / \mu$ in the larger population).
- (2) The larger population can be considered infinite in size. The sperm whales studied off the Galápagos between January and June seemed to be on a Northern Hemisphere reproductive schedule (Whitehead, Weilgart and Waters, 1989), and so, in this model, they might be considered part of a large population inhabiting the whole North Pacific. This is equivalent to model (1) with $\mu=0$ (as the probability of a group migrating back into the Galápagos area is virtually zero).
- (3) We are sampling from a closed Galápagos population. This is equivalent to $\mu=0$ and $\lambda=0$ in (1).

RESULTS

Groups of females and immatures

Tests for equal catchability (all individuals equally identifiable) and for fit to the multinomial model (no individuals joining or leaving groups during the study) were performed on each derived group. The following significant (at $P < 0.05$) failures were found: a new set of whales appeared to join G4 on 11 March 1985; 3–4 'new' whales seemed to join H3 on 13 June 1987; H12 probably consists of two or more distinct groups inadvertently joined by the clustering process; only a small (about 7 members) 'sub-group' of H13 was identified during three of the four days that this group was observed.

Twelve and 23 primary groupings were identified in 1985 and 1987 respectively (Tables 2 and 3). Because of the lack of robustness of the Schnabel mark-recapture technique to immigration and emigration, and the fact that the data were from derived groupings and not a randomly mixed population, the estimated group sizes in Tables 2–3 should be viewed with some caution. However, in most cases the groups seemed closed and in some (those with small standard errors in their estimated population sizes) most individuals were identified many times. For these groups, the estimated population sizes given in Tables 2 and 3 are probably accurate. Thus, the weighted mean (and median) group sizes of 21–22 individuals (SDs 6–11) for both years given in Table 7 are meaningful. These group size estimates exclude first-year calves, and may be negatively

biased by up to 9% if some members of the population were not identifiable by our identification methods (Arnbom, 1987).

Table 7

Mean weighted and median estimated group sizes, from estimates in Tables 2 and 3. The weighting for each estimate i was $1/(s^2 + \sigma_i^2)^{0.5}$ where s^2 is an estimate of the variance between all the estimates and σ_i is the estimated standard error of estimate i .

	1985	1987	Overall
Mean weighted group size (SD)	21.0 (5.84)	21.6 (11.0)	21.4 (9.31)
Median group size	22.0	21.2	21.8

In general the maximum number of whales seen at any time from a group agree with the group population estimates (Tables 2 and 3): for 13 of the 22 1985 and 1987 groups for which population estimates were made, the estimated group size was within two individuals or two estimated standard errors of the maximum number seen; for six of the remaining groups the maximum number seen was less than the estimated population size. In only three cases (for groups G1, G3 and H5) was the maximum number of whales sighted greater than the estimated population size plus two individuals or two standard errors. These probably represent instances where two groups were associating but only members of one were identified.

In each year, four primary groupings were identified over periods longer than one month (Tables 2 and 3), but there was no obvious tendency for these to be the groupings that were identified in both years (Table 6). The temporal pattern of identifications with time in 1987 (Fig. 1) suggests that some groups (especially H12) may have left our study area and later returned. From Tables 2 and 3 it appears that, on average, groups in 1985 remained longer in the study area. However, it is likely that this effect is largely, or even totally, an artifact of the greater intensity of effort (days at sea per month) in 1985.

The positions in which groups were first sighted are given in Fig. 2. In the 1987 plot a north-south line can be drawn near Isabela Island with groups only being sighted on one side or the other of it. This is probably because the overall sperm whale distribution is mainly to the east of this line in January, February, May and June and to the west in March and April (Whitehead *et al.*, 1989). Further evidence that this line is an artifact of changing seasonal distributions and does not represent a population division is that H5, found to the east of the line in 1987, was much the same group as G2 (Table 6), found to the west of the line in 1985 (Fig. 2). Clusters of first sighting positions of particular groups (e.g. H3, H8) are generally from consecutive days. Thus it seems that individual groups used large parts of the waters around the Galápagos, and there are probably no preferred ranges or territories.

Primary groups were observed to associate with other primary groups. Two pairs of groups associated on more than one day. The close association of H12 and H13 in 1987 (seen together on three consecutive days) may be at least partially due to the limitations of the clustering process. The repeat associations between G3 and G8 were four days apart.

Members of six of the groups identified during 1985 were reidentified during 1987 (Table 6). The case histories are summarised below.

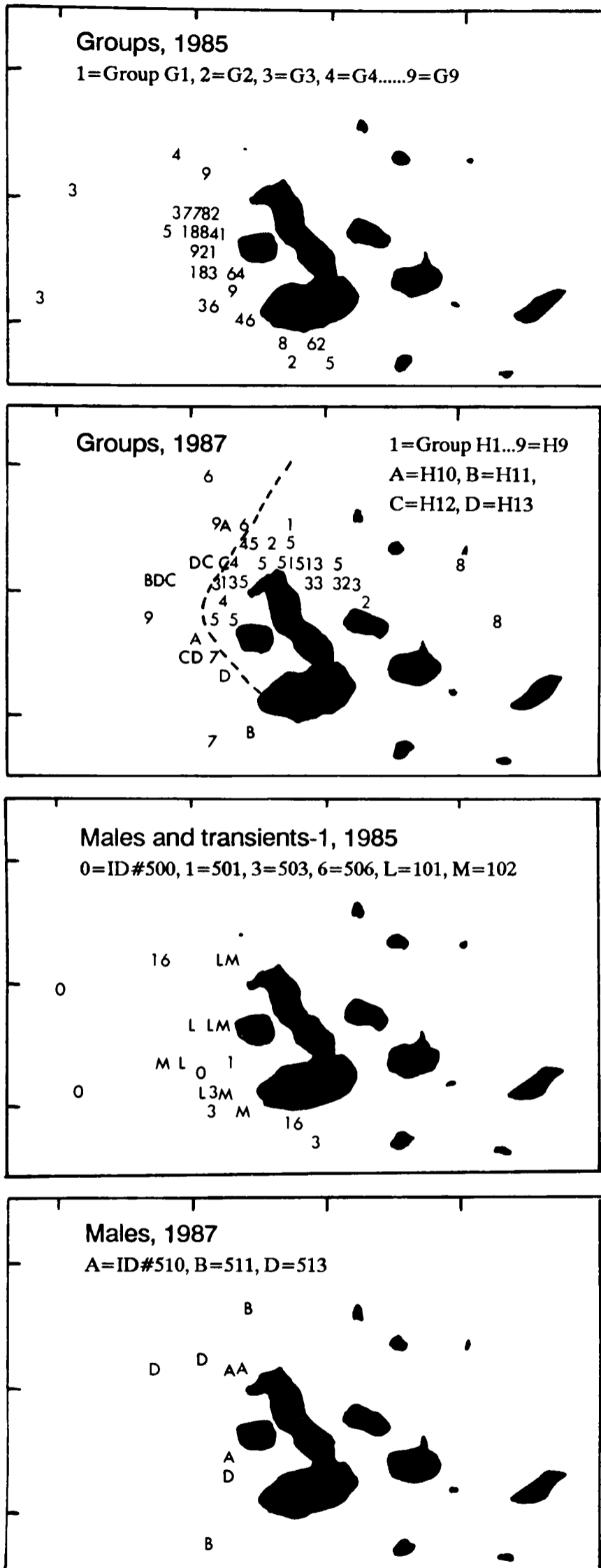

Fig. 1. Sighting dates for groups identified in 1987 on more than one day.

(a) One member of G1 (1985) was identified in H6 during 1987. As most members of both groups were identified in both years, this individual appears to have changed groups over the two year interval.

(b) Eighteen members of G2 (1985) were reidentified in H5 during 1987. Both G2 and H5 were sighted frequently. The population estimates (35.9 in 1985, 25.2 in 1987 and 33.2 for the years combined) suggest that H5 was G2 minus about 10 individuals.

(c) Four members of G4 (1985) were identified in H20 during 1987. H20 may represent G4 plus some new whales, or these four may have split from the main bulk of G4.

(d) Three members of G7 (1985) were identified in H4 during 1987. As most members of both groups were identified in both years, this 'subgroup' appears to have moved between groups over the two year interval.

(e) Two members of G7 (1985) were identified on 12 March 1987. They were the only whales identified with a grade greater than 3 on this day, and were identified five hours apart from one another. It may be that G7 (or H4 or another group) was present on this day, but we cannot tell. These data suggest that some or all of the 'secondary' groups are unidentified members of larger groups.

(f) Eight members of G9 (1985) were identified with H21 during 1987. The population estimates are consistent if H21 consisted of G9 plus some others.

(g) Eight members of G13 (1985) were identified with H8 during 1987. The population estimates for 1987 and the two years combined are consistent with G13 and H8 being identical in membership.

Thus it seems that at least three of the groups sighted during 1985 retained much the same membership in 1987 (b, f and g above) although there were differences in at least two of the groups. Some of this will have been due to recruitment and mortality, or, possibly, to changes in the fluke patterns so as to make them unrecognisable, but there is also evidence of transference between groups, in one case by three individuals together (d above). Assuming transference or the lack of it are equally easily detected in these kinds of comparisons, we can roughly estimate the rate of transference between groups over two years by comparing the numbers of individuals that probably changed groups, 4 (a+d, above), with those that probably did not, 34 (b+f+g, above). By this methodology the rate of transference is about 10% over two years.

These individuals may either have been continually moving between groups, or have transferred quickly from one group to another, then remaining with it, or have adopted some intermediate pattern of association.

Large males and their associations with groups of females

Attributes of the seven large males identified in 1985 and the six identified in 1987 are presented in Tables 4 and 5. Those measured photographically had lengths between 12.7 and 16.4m. Although the 1987 males seem generally smaller than those identified in 1985, some larger animals were present: one unidentified 1987 male was photographically measured at 16.2m.

In each year only two males were identified over periods longer than ten days, and the rate of sighting males changed considerably through both studies (Whitehead *et al.*, 1989). Thus the males seemed generally to spend only short periods of time in the Galapagos area, and no males were identified in both 1985 and 1987. However, those males that were identified were resighted reasonably frequently. Thus the total number of males visiting the Galapagos during the studies was probably not many times

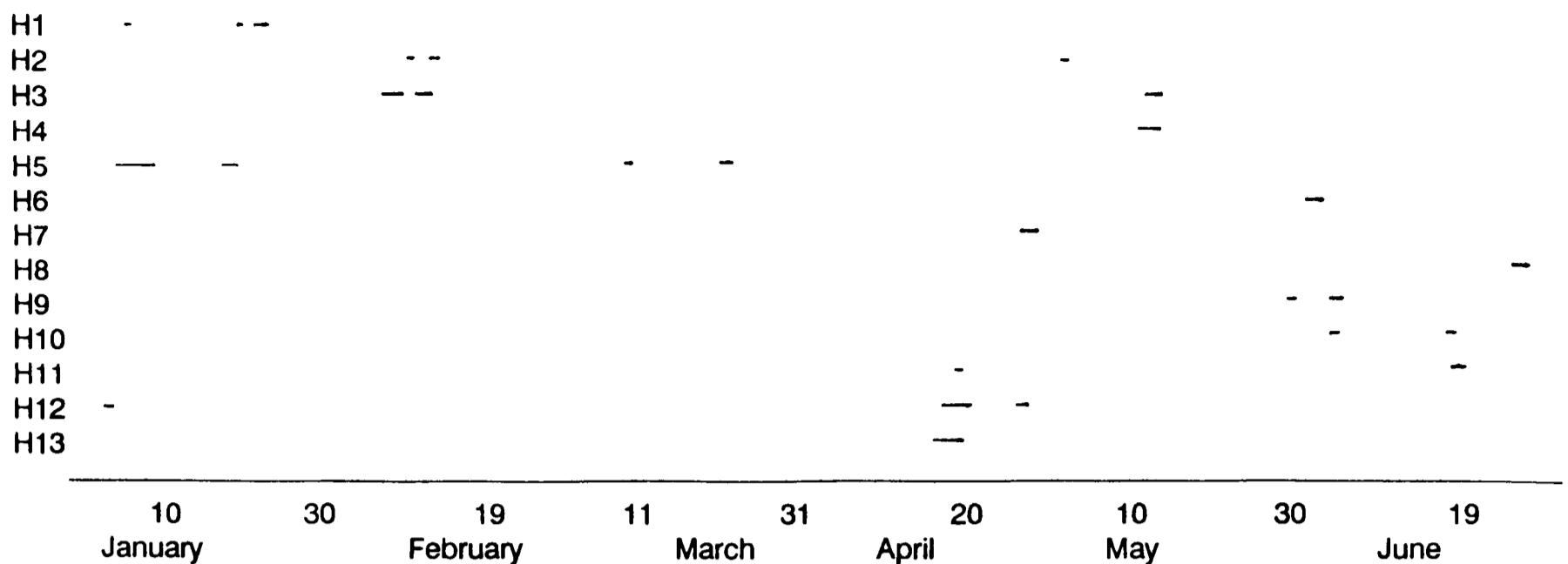

Fig. 2. First sighting positions on each day of those groups, males and transients-1 which were sighted on more than one day. For the 1987 groups a dashed line is drawn so that groups were only sighted on one side or the other of it.

greater than the number identified, confirming the low proportion of males indicated by visual counts (Whitehead *et al.*, 1989). Sighting rates suggest that the proportion of males present off the Galápagos peaked at 2% in 1985 (April) and 3% in 1987 (May) (Whitehead *et al.*, 1989).

The positions of those males identified on more than one day (Fig. 2) do not suggest any preferred ranges or territories for the males within our study area. The males were generally found more frequently in the western part because this is where the general concentrations of whales were during the periods (especially March-April) when males were most common (Whitehead *et al.*, 1989).

Although more than one male could sometimes be seen together, the only evidence of consistent coalitions between individual males is for males 501 and 506 in 1985. These individuals were seen together on both days that 506 was identified, and on two of the three days that 501 was identified.

Five of the identified large males associated with more than one group of females and four groups of females associated with more than one male (Tables 4 and 5). In five instances, particular males and groups were identified on more than one day, but four of these were on adjacent days, and the fifth pair (group H13 with male 513 in 1987) were associated on three of four consecutive days.

Using recordings of slow clicks as a guide, we estimate that groups of females were attended by one or more large males about 16% of the time in 1985 and 12% of the time in 1987, although these proportions varied with season (Whitehead *et al.*, 1989). The durations of the encounters varied from 5min to 20hr, although it was often hard to tell exactly when a male joined or left a group. Measurements of the duration of contacts were also hampered by associations between groups, and between males, and because during tracking we occasionally inadvertently changed the group that we were following. However, on 14 occasions in 1985 and 17 in 1987 only one group was identified immediately before, during and after the presence of the male or males was recorded. These had a mean duration of 5.7hr (SD 5.5hr) in 1985 and 3.1hr (SD 3.6hr) in 1987. There was no significant difference in these durations between years (Mann-Whitney U Test, $P=0.69$). There was a tendency for durations of encounters between males and groups of females to be longer in April than earlier or later in the year although this trend was not statistically significant (Whitehead *et al.*, 1989).

Transients

Two transients-1 were identified during 1985 and none in 1987. These two, nos 101 and 109, were both identified on the same five days in March, but only once together in the same 5min interval. On two of these days they associated with group G1 and 101 was also seen with G1 in February, although both 101 and 109 associated with a variety of other groups.

The six transients-2 (5 in 1985 and 1 in 1987) also associated with a variety of groups, as well as with males.

Thirteen transients-3 were identified (6 in 1985 and 7 in 1987). As we were uncertain as to whether these animals were transferring between groups, they are only being used in an examination of the general characteristics of transients.

It has been possible to determine for four transients (one transient-1, one transient-2, and two transients-3, all from 1985) whether or not a callus was present on the dorsal fin. All four animals possessed calluses, suggesting that they are mature females (Kasuya and Ohsumi, 1966; Gordon, 1987).

Some of the designations as transients, especially for transients-3 and occasionally for transients-2, could be artifacts of the temporal patterns of identification, and these animals may have been permanent members of stable groups. In addition, to recognise a transient as such, identification data from at least two, and usually more, days are required. Therefore, there were probably other animals transferring between groups within the study area, and the true proportion of transients present at any time is hard to determine from our data.

There is no indication that either of the transients-1 possessed home ranges or territories within the study area (Fig. 2).

Population size and migration

The three models of migration and population size were tested using the method developed by Whitehead (in press), and outlined in the Methods section, with the months in which groups were identified used as data. The parameters N , μ and λ were estimated for the three models, and the fit of the different models to the data was compared by means of likelihood ratio tests. The results are given in Table 8. Whitehead (in press) presents values of the support function for N and μ which suggests 95% confidence intervals for N of about 9–33 groups, and μ of

0–0.18 groups/month. Models (1) and (2) fit the data significantly better than model (3), but we cannot choose between (1) and (2) although (2) has fewer parameters and is thus more parsimonious.

Table 8

Fit of data on capture histories of sperm whale groups around the Galapagos Islands to three models of population size and geographical structure. Log-likelihoods and maximum likelihood estimates of the parameters of the model are given for each model. Results of likelihood ratio tests of the models are given beneath.

Model:	Log Likelihood	Max.Likelihood Estimate:		
		N	λ	μ
(1) Immigration/emigration from closed population	43.017	14.78	0.237	0.057
(2) Immigration/emigration from infinite population, $\mu=0$	43.781	21.74	0.050	
(3) Closed population, $\mu=0, \lambda=0$	48.228	36.36	-	-

Likelihood ratio tests:

(2) vs (1) - Presence of re-immigration:
 $-2 \cdot \log[L(N, \lambda, \mu)/L(N, \lambda, 0)] = 1.528$ ($\chi^2, 0.25 > P > 0.1$)

(3) vs (2) - Presence of emigration:
 $-2 \cdot \log[L(N, \lambda, 0)/G L(N, 0, 0)] = 8.894$ ($\chi^2, P < 0.005$)

The data, therefore, are consistent with either: (1) there are about 15 groups off the Galápagos at any time, with a turnover of about 3.5 ($\lambda \cdot N$) groups per month within a larger closed population of about 76 groups $N \cdot (\lambda + \mu) / \mu$; or (2) there about 22 groups off the Galápagos at any time with a turnover of about 1 ($\lambda \cdot N$) group per month from a very large population. The data are not consistent with sampling from a closed population of groups off the Galápagos.

Whitehead (in press) lists seven assumptions for the use of this technique. With reasonably closed groups of whales used as units, as here, four of these assumptions (equal probability of capture for groups in the study area, identification does not affect the behaviour of the groups, no groups become unidentifiable, and groups are not born and do not die during the study period) are probably approximately valid. Violations of the other three assumptions (that there are no differences in emigration and re-immigration probabilities between groups, and that sampling periods are infinitely short in duration) tend to have only small effects on mark-recapture estimates.

DISCUSSION

Comparison with results of 1985 study

Most of the results from the 1987 study, as well as those from the reanalysis of the 1985 data, are in agreement with the original 1985 results presented by Whitehead and Arnborn (1987). These include: the median group size; the proportion of large males present; the lack of territories or home ranges within the study area; and the diversity and duration of associations between large males and groups of females. However the 1987 data, and reanalysis of 1985 data, suggest modification of some of the 1985 results: a lower rate of association between groups (because of the removal of transients); the size of adult males (lower size limit 12.8m in 1987 compared with 13.7m in 1985); the movement of individuals between groups (both within and between the studies); and the movement of groups into and out of the study area. These modifications are relatively minor, and the implications of the results of the 1985 study

for the conservation and management of sperm whale populations, as discussed by Whitehead (1987), also generally arise from the analysis described in this paper. Additionally, comparison of identifications between the two studies has given information on the population size, the rates of migration and the stability of groupings.

Clustering

Much of our analysis depends on the ability to cluster individuals into (nearly) closed groups. Generally the procedure works well: clustered groups showed morphological differences (Arnborn and Whitehead, 1989), identified calves stayed within groups (Whitehead and Arnborn, 1987), group population estimates generally agreed with numbers sighted (Tables 2 and 3) and some groups maintained much of their membership two years later (Table 6). However, as the retrieval of transients-1 and the confusion of H12 and H13 show, the clustering technique is not perfect. It appears that, occasionally, two individuals from different but associating groups were identified close together in time. This may have led to either the artificial fusion of the original groups by the clustering process, or the misgrouping of individuals. Transients not recognised as such, and individuals designated as transients which were not, will also cause problems.

To test the potential of other clustering techniques for resolving these ambiguities, we calculated the mean association of each individual identified in 1987 with all members of all groups. If the clustering process could be improved we would expect a number of individuals to be more closely associated with groups other than the one to which they were allocated. However, only six such individuals were identified: five were transients, and one a member of H12 which was more closely associated with H13. This suggests that, given the data collected, the original cluster analysis cannot be much improved.

The uncertainty of the clustering is probably reasonably well expressed by the estimated standard errors of the population estimates in Tables 2 and 3: those groups like H1, whose members were seen frequently, are likely good representations of true groupings; others, like H7, whose members were only seen once or twice should be treated cautiously.

Social organisation and population structure – females and immatures

Off the Galápagos, female and immature sperm whales formed groups of about 21 individuals. This excludes first-year calves, large males and transients associating with the group, as well as a maximum of 9% individuals which are unidentifiable by our methods (comparisons of the maximum number of individuals sighted from each group and the estimated population sizes in Tables 2–3 indicates that very few individuals were not identifiable).

A few transient whales, some of which were probably females, moved between groups. Because of the difficulties in recognising transients, we cannot give a good estimate of the proportion of transients in the population. However, in January and February 1987, when a few groups were clearly defined and identified frequently, no transients-1 or transients-2 were identified, suggesting that these form a small part of the population.

From a comparison of the groupings within which individuals identified in both 1985 and 1987 were seen, we estimate that about 5% of individuals change groups

between adjacent years. Because of uncertainty in the clustering process, and other parts of the methodology in obtaining this estimate, it should be treated cautiously. We do not yet have any indications of the sex or size of these transferring individuals, although we may have data to examine this. These transferring individuals may or may not include the transients. But, because of the independent evidence mentioned above suggesting the stability of the groups, we think it likely that a few individuals may repeatedly transfer between groups, rather than all individuals having a slow rate of transfer.

There is considerable interest in the stock structure of the sperm whales in the Pacific, especially the North Pacific (e.g. IWC, 1987; Kasuya and Miyashita, 1988). The status of the stock of sperm whales around the Galápagos is particularly uncertain (Rice, 1977). The data that we analysed are not consistent with the hypothesis that we were sampling a closed population of groups around the Galápagos. The data are consistent with groups moving into and out of the Galápagos area from a much larger Pacific population, or with groups moving into and out of the Galápagos area from a surrounding stock of about 76 groups. A decision as to which of these scenarios is more appropriate requires additional data over a longer time period.

These models suggest that there are about 9–33 groups, or 193–706 female and immature sperm whales off the Galápagos at any time (using a mean group size of 21.4 from Table 7).

Large males

The rather shorter lengths of the large males measured during 1987 indicates that some of the males we identified are not quite what Best (1979) called 'prime breeding bulls' (those over 13.7m). However, according to the age-length key of Ohsumi (1977) they should all be greater than 20 years old, and all were more than 12.5m, the length at which 50% of males may be fertile according to densities of spermatozoa in the seminal fluid (Best *et al.*, 1984).

In both years there were only of the order of ten large males present off the Galápagos, and individuals generally spent only short periods in the area, showing no consistent ranges or territories. The lack of males common to the two studies suggests that the males were being sampled from a population of at least 18 (using binomial theory with $P=0.05$).

In both years, males generally spent only periods of a few hours, or at the most a few days (as suggested by the repeat associations on consecutive days – Tables 4 and 5), with particular groups of females, and associated with a variety of groups of females.

Further work

Additional analyses that we are carrying out on the 1985 and 1987 data which relate to social organisation and population structure include an investigation of the internal structure of groups: length and sex distributions, calving rates, and preferred companionships.

A short field project was carried out in April 1988 off the Galápagos, and a longer one in 1989. A major goal of this work was to collect more fluke photographs. These are being used to estimate the rate of transference of individuals between groups, the population structure of the sperm whales off the Galápagos (deciding between models (1) and (2) above), and examining the rates of change of fluke patterns. We are also collecting skin samples for

DNA analysis, so that we may compare the degree of relatedness within and between groups, between large males and others, and between sperm whales from the Galápagos and other areas.

We have made an examination of 19th century logbooks, comparing our observations off the Galápagos (with regard to geographical distribution, the presence of calves and large males, and the seasonal variation of these) with those of the whalers. Estimates of removals from the Galápagos region and changing catch rates (Bannister, Taylor and Sutherland, 1983; Shuster, 1983) are being examined with reference to population models obtained from modern data (P. Hope and H. Whitehead, in prep.).

ACKNOWLEDGEMENTS

Those who took part in, funded, and assisted the 1985 study are acknowledged in Whitehead and Arnborn (1987). The 1987 study and analysis was funded principally by an operating grant and University Research Fellowship (to H.W.) from the Natural Sciences and Engineering Research Council of Canada, and grants from the International Whaling Commission and the Dalhousie University Research Development Fund, with a generous contribution from Wild Country Productions. World Wildlife Fund kindly loaned equipment. We are very grateful to the crew of *Elendil* (in chronological order): Margo Rice, Dan Loehr, Garry Kealy, Linda Weilgart, Cheryl Hendrickson, Caroline Smythe, Bill Lambert, Matt Friedl, Miguel Zatapin, David Day, Xavier Romero, Katherine Lynch, Benjamin Weilgart-Whitehead, Leesa Fawcett, Susan Staniforth, George Prehmus, Jennifer Staniforth, Sean Smith, Tui de Roy, and Gary Kendrick. We thank the Estación Científica Charles Darwin, and especially Sylvia Harcourt and Henk Kasteleijn for support and assistance. Juan Black helped us greatly in Quito and Godfrey Merlen and Gail Davis came to our rescue several times. The hospitality of Frau Erna Sievers and the practical assistance of Rolf Sievers were also greatly appreciated. We are grateful to Tom Arnborn, Carole Carlson and Linda Weilgart for their part in the analysis. Ian McLaren and Linda Weilgart of the Biology Department, Dalhousie University, Halifax, Nova Scotia, Canada B3H 4J1, Robert Clarke of San Andrés, Pisco, Peru, and an anonymous referee usefully reviewed the manuscript.

REFERENCES

- Arnborn, T. 1987. Individual identification of sperm whales. *Rep. int. Whal. Commn* 37: 201–4.
- Arnborn, T. and Whitehead, H. 1989. Observations on the composition and behaviour of groups of female sperm whales near the Galápagos Islands. *Can. J. Zool.* 67: 1–7.
- Bannister, J.L., Taylor, S. and Sutherland, H. 1983. Logbook records of 19th Century American sperm whaling: a report on the 12 month project, 1978–79. *Rep. int. Whal. Commn* (special issue 5): 243–55.
- Best, P.B. 1979. Social organisation in sperm whales. pp. 227–89. In: H.E. Winn and B.L. Olla (eds) *Behavior of Marine Animals, Vol. 3, Cetaceans* Plenum Press.
- Best, P.B., Canham, P.A.S. and Macleod, N. 1984. Patterns of reproduction in sperm whales. *Physeter macrocephalus*. *Rep. int. Whal. Commn* (special issue 6): 51–79.
- Gordon, J.C.D. 1990. A simple photographic technique for measuring the length of whales from boats at sea. *Rep. int. Whal. Commn* 40: 581–8.
- Gordon, J.C.D. 1987. Sperm whale groups and social behaviour observed off Sri Lanka. *Rep. int. Whal. Commn* 37: 205–17.
- International Whaling Commission. 1980. Report of the sub-committee on sperm whale research needs. *Rep. int. Whal. Commn* (special issue 2): 124.

- International Whaling Commission. 1987. Report of the sub-committee on sperm whales. *Rep. int. Whal. Commn* 37: 60-7.
- Kasuya, T. and Miyashita, T. 1988. Distribution of sperm whale stocks in the North Pacific. *Sci. Rep. Whales Res. Inst., Tokyo* 39: 31-75.
- Kasuya, T. and Ohsumi, S. 1966. A secondary sexual character of the sperm whale. *Sci. Rep. Whales Res. Inst., Tokyo* 20: 89-94.
- Ohsumi, S. 1977. Age-length key of the male sperm whale in the North Pacific and comparison of growth curves. *Rep. int. Whal. Commn* 27: 295-300.
- Rice, D.W. 1977. Sperm whales in the Equatorial eastern Pacific: population size and social organisation. *Rep. int. Whal. Commn* 27: 333-6.
- Seber, G.A.F. 1982. *The Estimation of Animal Abundance and Related Parameters*. 2nd Ed. Griffin, London.
- Shuster, G.W. 1983. The Galápagos Islands: a preliminary study of the effects of sperm whaling on a specific whaling ground. *Rep. int. Whal. Commn* (special issue 5): 81-2.
- Weilgart, L.S. and Whitehead, H. 1988. Distinctive vocalisations from mature male sperm whales (*Physeter macrocephalus*). *Can. J. Zool.* 66: 1931-7.
- Whitehead, H. 1987. Social organisation of sperm whales off the Galápagos: implications for management and conservation. *Rep. int. Whal. Commn* 37: 195-9.
- Whitehead, H. In press. Mark-recapture estimates with emigration and re-immigration. *Biometrics*.
- Whitehead, H. and Arnborn, T. 1987. Social organisation of sperm whales off the Galápagos Islands, February-April 1985. *Can. J. Zool.* 65(4): 913-9.
- Whitehead, H. and Gordon, J. 1986. Methods of obtaining data for assessing and modelling sperm whale populations which do not depend on catches. *Rep. int. Whal. Commn* (special issue 8): 149-66.
- Whitehead, H., Weilgart, L.S. and Waters, S. 1989. Seasonality of sperm whales off the Galápagos Islands, Ecuador. *Rep. int. Whal. Commn* 39:207-10.

Using Photo-Identification to Study Pilot Whale Social Organization

Susan H. Shane and Dan McSweeney

West Coast Whale Research Foundation, U.S., P.O. Box 1768, Santa Cruz, CA 95061, USA.

ABSTRACT

Photo-identification of uniquely-marked individuals was the primary research tool used in studies of pilot whale (*Globicephala macrorhynchus*) social organization at Santa Catalina Island, California (1983–8) and the Big Island of Hawaii (1985–8). Pilot whales showed fairly high site fidelity, especially in Hawaii. Pod cohesiveness over time was marked in Hawaii but less evident at Catalina. Pods in both study areas were composed primarily of presumed adult females with juveniles and calves. Presumed adult males were rare, and when seen, did not associate with the same pod all the time. Pair-wise association analyses at Catalina showed some degree of social affiliation between some individuals. Thirty-four to 45% of pilot whales in the two study areas were identifiable which compares favorably with bottlenose dolphins (44%) but is lower than humpback whales (92%) and Risso's dolphins (67–95%). Despite some problems, photo-identification is a promising technique for studying pilot whale social organization.

INTRODUCTION

Photographic identification of individual cetaceans has not been used previously in long-term studies of pilot whales (*Globicephala* spp.). Here, we present preliminary data from two photo-identification studies of short-finned pilot whale (*G. macrorhynchus*) social organization and discuss the problems associated with using photo-identification techniques to study this species.

One study was conducted during six consecutive winters at Santa Catalina Island, California (33°25'N, 118°35'W) from January 1983 to February 1988. Pilot whales traditionally have gathered in the nearshore waters (usually less than 1km offshore) of Catalina Island each winter to feed on aggregations of spawning squid, *Loligo opalescens* (Norris and Prescott 1961; Dohl, Norris, Guess, Bryant and Honig, 1978). Pilot whales were photographically identified at Catalina during four different winters (1983–1986) and off the southern California mainland (Palos Verdes Peninsula) during one winter (December 1986). There were no pilot whales seen at Catalina during two winters (1987–1988).

The second study was conducted nearly year-round from 1985–88 off the island of Hawaii (19°40'N, 156°10'W). Pilot whales in Hawaii usually were seen along a 40km stretch of the Kona coast, 5–16km offshore. The present analysis is based on a sample of five encounters with pilot whales in Hawaii, including three days in 1986 and two days in 1987. These five days were selected because one distinctively-marked individual was present on each occasion.

MATERIALS AND METHODS

Research at Catalina was conducted from a 5m *Boston Whaler* with an 85hp *Evinrude* outboard engine. Pilot whales were photographed using a *Canon AE-1* camera with 70–210mm zoom lens and power winder. Most photographs were taken using *Kodachrome* 64 color transparency film at shutter speeds of 1/125 to 1/1000 of a second. On occasion, *Ektachrome* 200 color transparency film or *Tri-X* (ASA 400) black and white film were used. All photographs taken of pilot whales from 1983–86 (approximately 1,600 color transparencies and 550 black

and white negatives) were considered in this analysis. Color transparencies of a pod of about 25 pilot whales off Palos Verdes Peninsula, 35km north of Catalina, on 12 and 14 December 1986 and color transparencies taken in December 1980 and in April 1982 at Catalina were provided by other researchers (see Acknowledgements) and also used in the analysis. The choice of whether to use color transparencies or black and white film is not clear cut. *Tri-X* black and white film offers a high ASA with relatively little graininess, thus permitting the photographer to employ high shutter speeds under most conditions. However, color transparencies provide subtle details of fin characteristics that are often lost in black and white images, but with the low ASA of 64, high shutter speed is impossible under low light conditions.

The Hawaii study platforms were a 6m *Zodiac* inflatable with a 90hp *Mercury* engine and a 6m *Boston Whaler* with twin 60hp *Suzuki* engines. Two *Canon* cameras (A-1 and F-1), fitted with 400mm (f 4.5) and 300mm (f 2.8) lenses were used. *Tri-X* film was pushed to 1600 ASA and shot at shutter speeds of 1/1000 to 1/2000 of a second. A total of 757 contact images was evaluated in this analysis.

Individual whales were considered to have been identified only if they were sighted on at least two different days. One of us (SHS) sketched the whales' dorsal fins while viewing the photographs (slides, negatives or contact prints) through an 8X magnifying loupe. The sketches permitted rapid comparison of fins. When similar sketches were found, the two photographs were compared to determine whether the fins belonged to the same individual. In cases where a match was questionable, a second person was shown the photographs, and a match was scored only if both people agreed that the fins were the same. At Catalina, white dorsal saddle patterns supplemented dorsal fin marks in identifying some individuals.

The proportion of identifiable whales in Hawaii was calculated by determining the ratio between the number of identified fins and the total number of fin photographs that were clear enough to have been identifiable if identifying marks were present (N=535) on a sample of three days. We assume that the whales which might not have been photographed had the same ratio of identifiable to unidentifiable fins as those photographed.

Age class and gender were determined subjectively based on data in Kasuya and Marsh (1984). Data extrapolated from Kasuya and Marsh (1984) suggested that weaning has occurred by approximately age 3 (length = 260cm) and that mature females range in size from 320–360cm. Thus at Catalina any animal three-quarters of the length or less than an adult which it accompanied closely was considered a calf (i.e. $260/340 = 76\%$). Those whales which appeared significantly larger in total length and dorsal fin size than the next largest animals in the pod were presumed to be adult males.

Associations between individuals were based on whales occurring in the same pod. Shane (unpub. data) used Schaller's (1972) formula to measure the degree of association between pairs of identified whales during January-February 1983 at Catalina: a value of 1.0 meant that two whales were seen together at every sighting, whereas a zero meant two whales were never seen together.

RESULTS AND DISCUSSION

Among the many potential applications for photo-identification data (e.g. individual association patterns, site fidelity, population estimation, pod cohesiveness), we chose to focus on site fidelity and aspects of pilot whale social organization. Here we present results from a sample of the data we have collected on pilot whales in our two studies. From Catalina, all available data were used. From Hawaii, data were used from pods containing one focal animal on the assumption that these pods were representative of the population as a whole.

Site fidelity

Day-to-day and year-to-year resightings of recognizable individuals can indicate the degree of fidelity to an area. Thirty-two whales were sighted on two or more days at Catalina (Fig.1). Fifteen of these whales were sighted during two or more seasons. In Hawaii, 30 whales were sighted two or more times (Fig.2). Twenty-seven of these 30 whales were seen during both years.

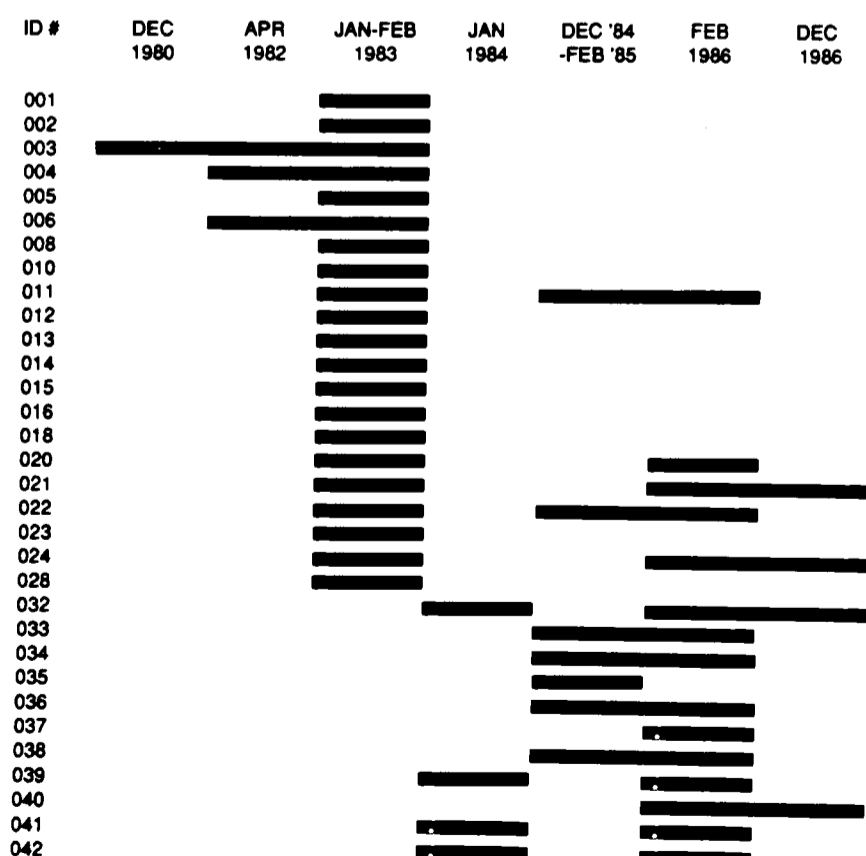

Fig. 1. Sightings of individually-identifiable pilot whales at Santa Catalina Island from 1980 through 1986 and at Palos Verdes Peninsula, California in December 1986.

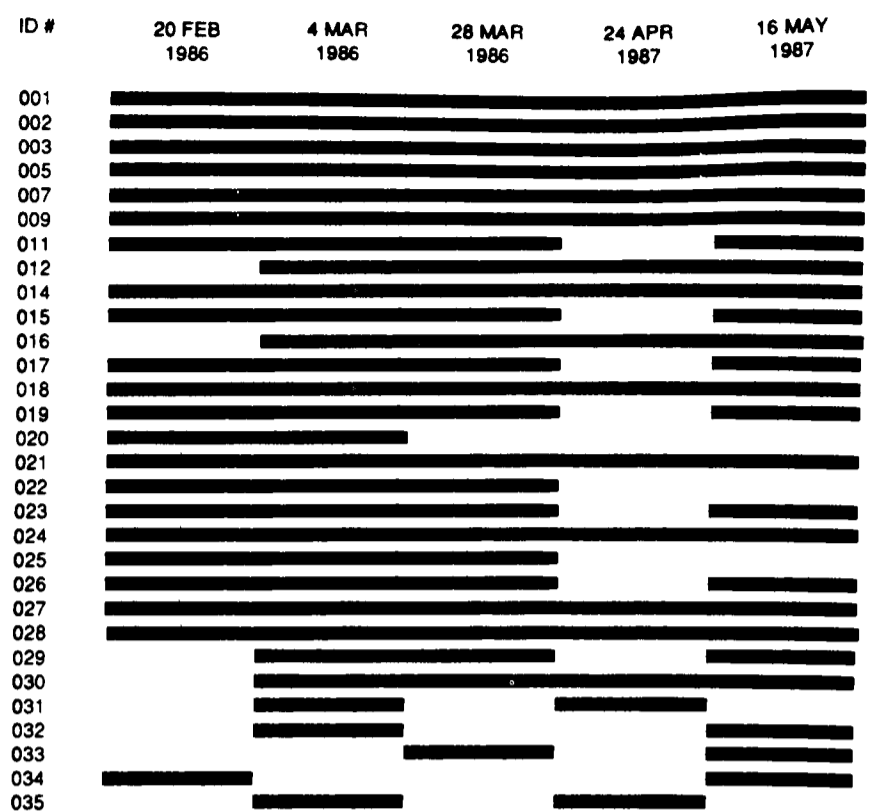

Fig. 2. Sightings of individually-recognizable pilot whales off the Kona coast of Hawaii on five days in 1986 and 1987.

These results suggest a relatively high degree of at least seasonal site fidelity in pilot whales, particularly in Hawaii. Most of the whales in Hawaii were seen repeatedly within and between years in the same area. Pilot whale occurrence at Catalina was severely disrupted by the 1982–3 El Niño event (Shane, 1985). This anomaly must be considered when interpreting the lack of absolute fidelity of individual whales to the Catalina area each winter. Of course the failure to sight an individual whale does not necessarily mean that it was not present. Gaps in our data may cause us to underestimate site fidelity and pod cohesiveness.

Pod cohesiveness

The number of identifiable whales in common between four pods sighted during four winters in southern California ranged from one to six. Pod cohesiveness within one season was demonstrated by a group of 20 pilot whales which always were seen together and never with any other pilot whales from 29 December 1984 to 28 February 1985 (Shane, 1985).

In Hawaii, 12 of the 30 pilot whales seen two or more times were seen together on all five study days. Nine whales were seen on four days, three on three days and six on two days.

These results indicate a higher degree of pod cohesiveness in Hawaii than in California.

Pod composition

January-February 1983 was the only winter when many different pods were encountered at Catalina. During that time presumed adult males were seen rarely, and there was never more than one per pod (Shane, unpub. data). Of all pilot whales seen during that season, 7.7% were calves. Calves comprised 19.6% (± 7.4) of the whales in a subset of pods containing immature animals that winter. The pod of 17 seen in January 1984 at Catalina was composed entirely of whales the size of adult females or subadult males (Shane, 1984). The 1984–5 pod of 20 contained 19 whales of adult female/subadult male size plus one calf (5%) (Shane, 1985). The February 1986 pod of 33 contained 30 whales of adult female/subadult male size,



Fig. 3. Photographs of one identified pilot whale (Catalina ID, no. 34) which indicate some of the problems associated with photo-identification. (A) Image is out of focus, so nicks are indistinct and the dorsal saddle is fuzzy. Scratches on the leading edge of the dorsal fin healed and vanished over time (photo taken in December 1984). (B) Intensity of dorsal saddle diminished as compared with 1984 due to light conditions. Dorsal saddle partially obscured by dorsal fin shadow (photo taken in February 1986). (C) Pattern on left side of dorsal saddle is completely different from that on the right side (photo taken in February 1986).

two juveniles and one calf (3%). There were no data on the composition of the pod photographed off Palos Verdes Peninsula in December 1986.

In Hawaii, one pod contained no presumed adult males. The remaining four pods each contained two to three presumed adult males (average = 6% of estimated pod size). Calves were not counted in Hawaii.

The presumed gender and size composition of pods in Hawaii and Catalina was consistent with what has been found in stranded and hunted pods of pilot whales (Sergeant, 1962; Kasuya and Marsh, 1984). Groups were dominated by presumed adult females accompanied by

juveniles and calves. Presumed adult males were comparatively rare and individual adult males did not appear to associate with the same pod all the time.

Individual associations

We quantified association patterns between individuals at Catalina but not Hawaii. Shane (1985) reported that two whales who may have been mother and offspring, based on observations in 1983, were found closest to one another more often than any other pair of whales in 1984–5. Forty-four pair-wise associations were calculated for pilot whales seen in the same pod at Catalina in 1983 (Shane,

unpub. data); ten associations had values of 0.50 or greater, indicating a degree of social affiliation between some individuals.

Problems with pilot whale photo-identification

Some of the problems encountered in our studies of pilot whales are common to any cetacean photo-identification study: (1) distant or out of focus photographs (Fig.3a); (2) photographs taken at an angle to the whale; (3) an insufficient number of photographs of a group, making it likely that some identifiable animals were missed; (4) changes occurring over time in the characteristics used to distinguish a given animal – scratches on the fin may last for weeks or even months but heal and vanish over a longer period of time (Fig. 3a).

An additional problem peculiar to pilot whale photo-identification involves the use of their white dorsal saddle patterns. Pilot whales in Hawaii have faint saddles, but they are only apparent underwater. At Catalina, not all whales have obvious saddles, and the saddles of those that do vary in visibility. Saddles are often partially or completely obscured by light conditions, water, the shadow the dorsal fin casts on the whale's back or by other whales surfacing beside the focal animal (Fig.3b). Since dorsal saddle patterns differ on the left and right sides of an individual, it is impossible to match photographs of the same animal using a left-side view and a right-side view unless there are distinctive nicks on the fin as well (Fig.3c).

Proportion of whales which were identifiable

Not all cetacean species are equally susceptible to photo-identification. We calculated that 33.5% (± 4.43) to 35.0% (± 3.27) of the Catalina pilot whales were identifiable, while 45.3% (± 2.89) of the pilot whales in Hawaii were identifiable. The percentage of identifiable bottlenose dolphins (*Tursiops truncatus*) in southwest Florida was 44% (± 0.059 ; Shane, 1987). B. Würsig (pers. comm.) estimated that 15–20% of spinner dolphins (*Stenella longirostris*), spotted dolphins (*S. attenuata*) and dusky dolphins (*Lagenorhynchus obscurus*) are photographically identifiable.

Other cetacean species have much more distinctive natural markings than do pilot whales. For example, one of us (DM) calculated that 92% of humpback whales (*Megaptera novaeangliae*) in a random sample of 534 flukes seen on 12 days in Alaska during 1983–85 were identifiable. Kruse (1989) estimated that 67.2% of Risso's dolphins in Monterey Bay are identifiable. She identified over 95% of the Risso's dolphins in one pod of 25 photographed for 4.3 hours. Since the effort per animal during this encounter was comparable to that for pilot whales in our studies, this estimate may more accurately reflect Risso's dolphin identifiability than does the 67.2% estimate.

Although pilot whales are not as distinctively marked as humpback whales or Risso's dolphins, they are roughly comparable to bottlenose dolphins in terms of the percentage of identifiable animals in a given population. Photo-identification studies of bottlenose dolphins have produced a rich understanding of the species (Würsig and Würsig, 1977; Ballance, 1987; Shane, 1987; Wells, Scott and Irvine, 1987), and the same can be expected from pilot whale research over the long term. The reason for the disparity between the proportion of identifiable animals in Hawaii (about 45%) and Catalina (about 34%) is unclear. It may be an artefact due to the relatively lower number

and quality of photographs taken at Catalina or it may be a real phenomenon. Information on the cause of the nicks and cuts on the dorsal fins will help to determine this.

CONCLUSION

Photo-identification is a promising technique for studying pilot whale social organization. Our data suggest that pilot whale pods are fairly stable. Perhaps they fit somewhere between the fluid groups of Hawaiian spinner dolphins (*S. longirostris*) (Norris and Dohl, 1980) and the very cohesive groups of killer whales (*Orcinus orca*) in the North American Pacific northwest (Bigg, 1982; Heimlich-Boran, 1986).

ACKNOWLEDGEMENTS

We are grateful to Eric Martin, Bill Samaras, Don Patten, Hubbs Research Institute and Dana Seagars for giving one of us (SS) access to their photographs of pilot whales in southern California for comparative purposes. Sallie Beavers cast the deciding vote in cases where a match between two dorsal fins was questionable. Bernd Würsig, Steve Reilly, Beth Mathews and two anonymous reviewers provided constructive ideas for editing the manuscript.

REFERENCES

- Ballance, L.T. 1987. Ecology and behavior of the bottlenose dolphin, *Tursiops truncatus*, in the Gulf of California, Mexico. M.S. Thesis. Moss Landing Marine Labs and San Jose State Univ., Moss Landing, California. 103pp.
- Bigg, M. 1982. An assessment of killer whale (*Orcinus orca*) stocks off Vancouver Island, British Columbia. *Rep. int. Whal. Commn* 32: 655–66.
- Dohl, T., Norris, K.S., Guess, R.C., Bryant, J.D. and Honig, M.H. 1978. Northeastern Pacific long-finned pilot whale, *Globicephala melaena scammoni*. pp. 269–295. In: Cetacea of the Southern California Bight, Draft Final Report: Summary of marine mammal and seabirds surveys of the Southern California Bight area 1975–78.
- Heimlich-Boran, S. 1986. Cohesive relationships among Puget Sound killer whales. pp. 251–284. In: B.C. Kirkevold and J.S. Lockard (eds.) *Behavioral Biology of Killer Whales*. Zoo Biology Monographs, Vol. 1. Alan R. Liss, Inc., New York. 457pp.
- Kasuya, T. and Marsh, H. 1984. Life history and reproductive biology of the short-finned pilot whale, *Globicephala macrorhynchus*, off the Pacific coast of Japan. *Rep. int. Whal. Commn* (special issue 6): 259–310.
- Kruse, S. 1989. Aspects of the biology, ecology and behavior of Risso's dolphins (*Grampus griseus*) off the California coast. M.S. Thesis. Univ. of California, Santa Cruz, California. 120pp.
- Norris, K.S. and Dohl, T.P. 1980. The behavior of the Hawaiian spinner porpoise, *Stenella longirostris*. *Fish. Bull.*, US 77: 821–49.
- Norris, K.S. and Prescott, J. 1961. Observations on Pacific cetaceans off Californian and Mexican waters. *Univ. Calif. Publ. Zool.* 63(4):291–402.
- Schaller, G.B. 1972. *The Serengeti Lion: a study of predator-prey relations*. Univ. of Chicago Press, Chicago, Illinois. 480pp.
- Sergeant, D.E. 1962. The biology of the pilot or pothead whale, *Globicephala melaena* (Traill) in Newfoundland waters. *Bull. Fish. Res. Bd Can.* 132: 1–84.
- Shane, S.H. 1984. Pilot whales and other marine mammals at Santa Catalina Island, California in 1983–4. Natl. Marine Fish. Serv., SWFC Admin. Rept. LJ-84–28C, 29pp.
- Shane, S.H. 1985. Detailed observations of a single pod of pilot whales and sightings of other marine mammals at Catalina Island, California in winter 1984–5. Contract report to U.S. Marine Mammal Commn. and Natl. Marine Fish. Serv., SWFC. 45pp.
- Shane, S.H. 1987. The behavioral ecology of the bottlenose dolphin. Ph.D. Dissertation. Univ. of California, Santa Cruz, California. 147pp.

Wells, R.S., Scott, M.D. and Irvine, A.B. 1987. The social structure of free-ranging bottlenose dolphins. pp. 247-305. *In*: H.H. Genoways (ed.) *Current Mammal.*, vol. 1. Plenum Press, New York and London.

Würsig, B. and Würsig, M. 1977. The photographic determination of group size, composition and stability of coastal porpoises (*Tursiops truncatus*). *Science* 198 (4318): 755-6.

Photographic Documentation of the Migratory Movement of a Humpback Whale (*Megaptera novaeangliae*) between East Australia and Antarctic Area V

Gregory D. Kaufman¹, Michael G. Osmond², Allan J. Ward³ and Paul H. Forestell¹

ABSTRACT

An adult humpback whale sighted in Antarctic Area V was resighted nineteen months later in Platypus Bay, Queensland, Australia on three occasions over a four-day period. The resightings were verified using both tail-fluke and lateral body markings. The resighting of this animal is the first photographic documentation of movement between the described areas, and provides support for the assumption, based on recovery of Discovery tags, that whales found along the east coast of Australia migrate from Antarctic Area V. The continued use of tail-fluke and lateral body markings should provide further important clarification of characteristics of humpback whale migratory patterns which could not be determined from Discovery tag studies.

INTRODUCTION

Humpback whales found off the east coast of Australia during the winter are believed to concentrate during the summer in the Antarctic in the vicinity of 150°E-180° (Chittleborough, 1965). Based on the recovery of Discovery tags (numbered steel tags fired into the body of a whale and recovered during flensing) from commercial whaling operations in the southwest Pacific Ocean, it has been assumed that essentially all whales from the east coast of Australia spend the summer in Antarctic Area V (Dawbin, 1964). However, it should be noted that of 1,871 whales marked in East Australia, New Zealand and Oceania between 1952 and 1962, only 56 were recovered (Dawbin, 1964). Allen (1980) pointed out that an unexplained low rate of tag recovery has been characteristic of humpback whales. Of approximately 4,000 humpback whales marked throughout the Southern Hemisphere since 1932, only 150 had been recovered by 1977 (Allen, 1980). The small proportion of Discovery tags recovered has prevented a more certain determination of the overall migratory patterns of humpback whales seen in east Australian waters. Since Area V humpback whales are no longer killed for commercial or scientific purposes, the continued elaboration of migratory patterns through the recovery of tags is no longer feasible.

In the last 15 years, the development of photo-identification techniques (e.g. Katona, Baxter, Brazier, Kraus, Perkins and Whitehead, 1979) has been successfully applied to documentation of humpback whale migratory patterns (e.g. Baker, Herman, Perry, Lawton, Straley, Wolman, Kaufman, Winn, Hall, Reinke and Ostman, 1986), population estimates (e.g. Darling and Morowitz, 1986; Baker and Herman, 1987) and analysis of patterns of social affiliations and life-history parameters (Glockner and Venus, 1983; see also Kaufman and Forestell, 1986) in the North Pacific. Only recently have these techniques been brought to the study of migratory

patterns in the South Pacific (Kaufman, Smultea and Forestell, 1987). The long-term study of humpback whale migration in the South Pacific through individual photo-identification should enable clarification of earlier findings based on the recovery of Discovery tags.

The potential success of photo-identification techniques is due in large part to the consistency of body markings over extended periods of time and the absence of bias in the likelihood of a given animal being photo-identified. Recent investigations of long-term changes in tail fluke patterns across years (Carlson, Mayo and Whitehead, 1990), and documentation of differences in age and sex class patterns in fluking behaviour (Perkins, Balcomb, Nichols, Hall, Smultea and Thumser, 1985; Rice, Carlson, Chu, Dolphin and Whitehead, 1987) have led to concerns about mark-recapture studies based solely on fluke photographs. We now report the first photographic documentation of extensive migratory movement by a humpback whale in the South Pacific (Figs 1 and 2). The

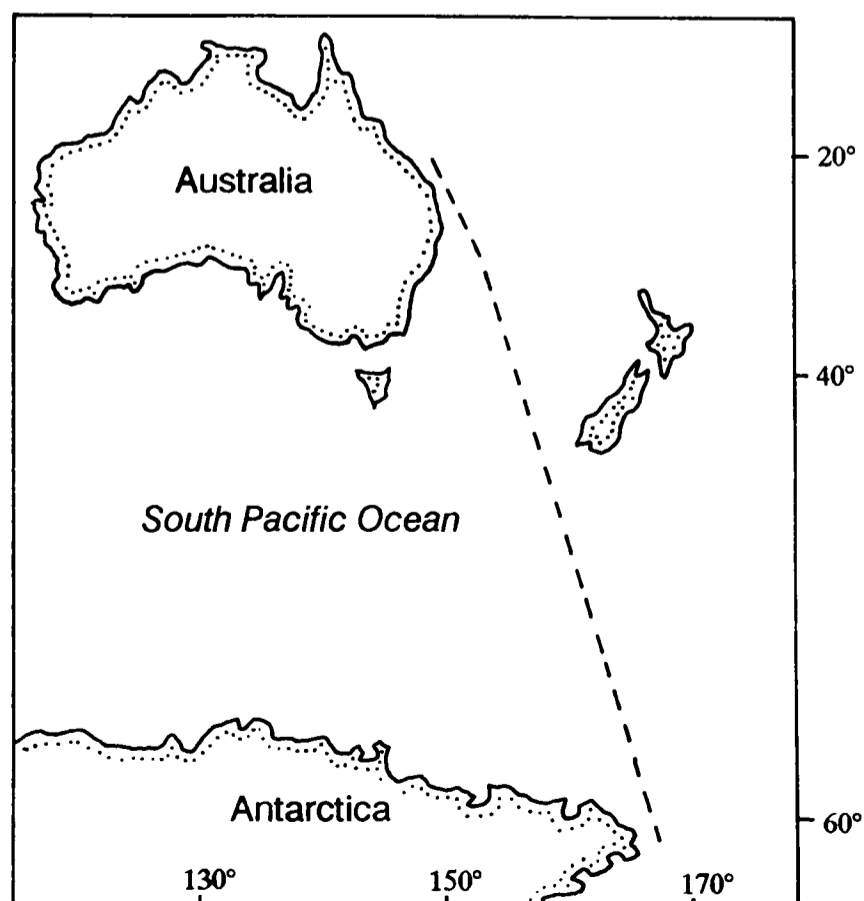

Fig. 1. Distance over which animal A0212 travelled between sightings.

¹ Pacific Whale Foundation, 101 N. Kihei Road, Kihei, Maui, Hawaii 96753, USA.

² Maritime Estate Management Branch, Department of Environment, Conservation and Tourism, PO Box 190, North Quay, Queensland 4002, Australia.

³ Sea Mammal Research Unit, High Cross, Madingley Road, Cambridge, CB3 0ET, UK.

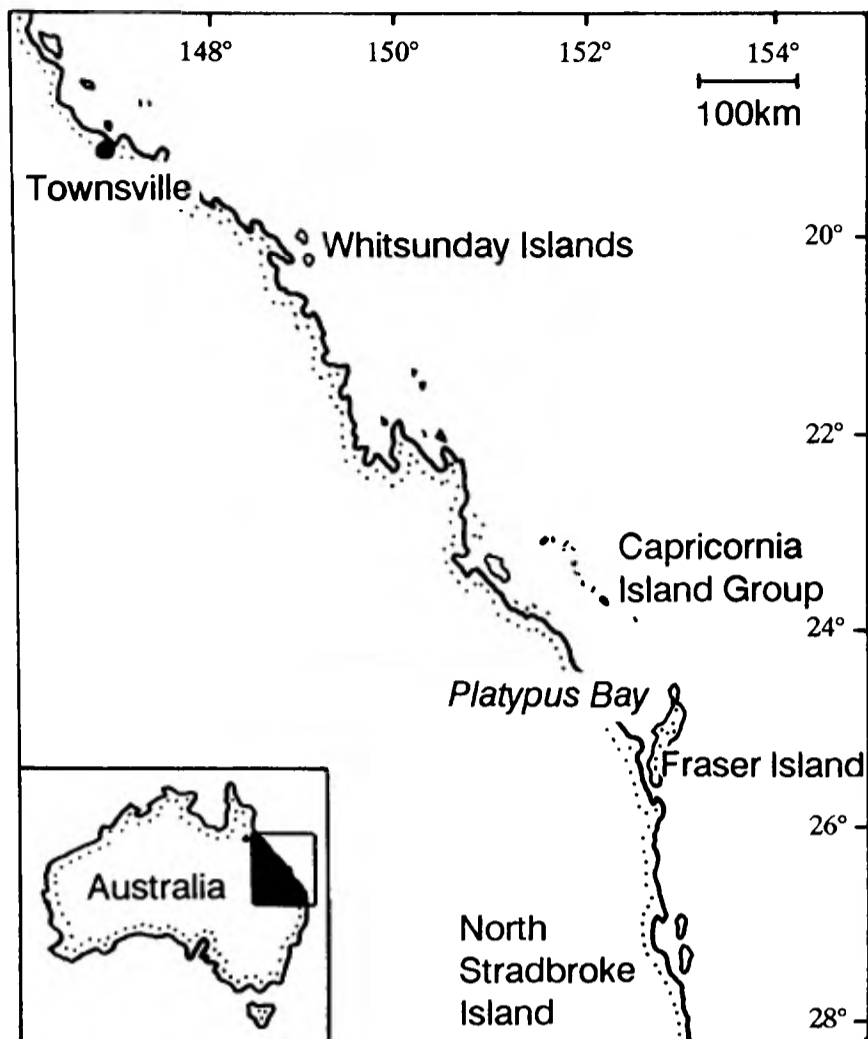

Fig. 2. Study area: Platypus Bay, Australia.

observations, based on both fluke and lateral body markings, are in keeping with suggestions by Hammond (1986) regarding photo-identification studies, and provide support for the hypothesis that Area V humpback whales migrate along the East Australia coast during winter months (Dawbin, 1964).

FIELD OBSERVATIONS

A humpback whale photographed in Antarctic Area V ($68^{\circ}46'S$, $170^{\circ}52'W$) by one of the authors (AJW) on an IWC/IDCR Southern Hemisphere minke whale assessment cruise on 7 February 1986 (Fig. 3) was entered into the Pacific Whale Foundation's South Pacific Humpback Whale Identification Catalog and assigned the reference number A0212. The identified animal was one of two adults observed within 2 km of the ice edge. Both animals remained stationary at the surface during the period they were observed.

Nineteen months later, the same whale was photographed in Platypus Bay, Queensland, Australia ($24^{\circ}57'S$, $153^{\circ}11'E$) approximately 3,500 km from where it was photographed in Area V. On 10 September 1987, animal A0212 was photographed with three adults quietly travelling at the surface inside Platypus Bay during the approximately 30-minute observation period. The ventral fluke and left lateral body patterns are shown in Figs 4 and 5. On 12 September, the same animal was photographed

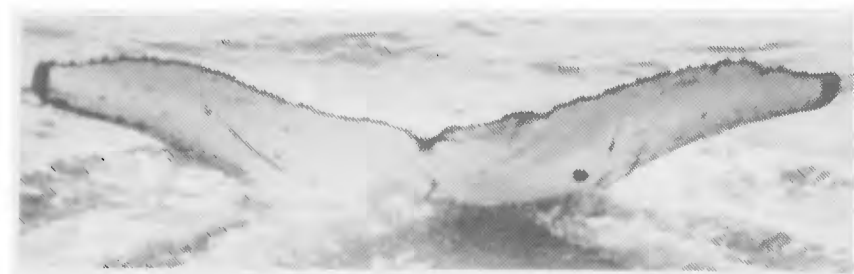

Fig. 3. Ventral tail-fluke photograph of A0212 taken February 7, 1986 in Antarctic Area V by Allan Ward.

by one of us (MGO) accompanying a mother and calf. Photographs of the flukes and left lateral body taken are presented in Figs 6 and 7. The same author photographed A0212 the following day, with four other adult whales. Only the left lateral body was photographed (Fig. 8).



Fig. 4. Ventral tail-fluke photograph of A0212 taken September 10, 1987 in Platypus Bay, Australia by Greg Krutzikowsky.



Fig. 5. Left lateral body photograph of A0212 taken September 10, 1987 in Platypus Bay, Australia by Greg Krutzikowsky.



Fig. 6. Ventral tail-fluke photograph of A0212 taken September 12, 1987 in Platypus Bay, Australia by Mike Osmond.



Fig. 7. Left lateral body photograph of A0212 taken September 12, 1987 in Platypus Bay, Australia by Mike Osmond.



Fig. 8. Left lateral body photograph of A0212 taken September 13, 1987 in Platypus Bay, Australia by Mike Osmond.

The animal accompanying A0212 during the Antarctic sighting has not been found among the approximately 600 photographs currently in the South Pacific Humpback Whale Identification Catalog. Resighting histories of the whales accompanying A0212 on September 10, 12 and 13 have not yet been determined, pending further analysis of our fluke and lateral body photographs.

GENERAL DISCUSSION

The markings of the flukes shown in the accompanying photographs showed little change during the 19 month interval between the Antarctic and Australian sightings. While detectable differences were found in some of the interior black markings, the characteristics of major fluke landmarks remained unaltered. In particular, the pattern of serrations along the trailing edge of the fluke did not change. Although major changes in fluke patterns have been established over both short- and long-term time periods, such differences have so far primarily been found in very young animals (Carlson *et al.*, 1990). Adults may show significant change as a result of bodily injury, particularly from encounters with boats, sharks, odontocetes and ectoparasites. It is important therefore to insist that verification of resightings be based on a number of points of correspondence between different types of markings. Hammond (1986) points out the importance of trying to assess the effects of any changes in patterns over time by using more than one type of marking.

Humpback whales found in the Southern Hemisphere exhibit a greater degree of white colouration than those found in the Northern Hemisphere (Chittleborough, 1965; Omura, 1953; Pike, 1953). Bryden (1982) noted that most of the tail flukes he saw in east Australia were uniformly white and indistinguishable. This fact, coupled with his observation that migrating east Australia whales seldom show the ventral surface of their flukes, led him to conclude that individual whales could not be photo-identified on the basis of tail fluke photographs. Since that time, however, researchers with the Pacific Whale Foundation and the Queensland National Parks and Wildlife Service have identified more than 600 individual whales, based on fluke photographs.

The taking of photographs of both flukes and lateral body markings is important. In fact, verification of the resighting of animal A0212 on 13 September is based entirely upon the identification of body markings along the left lateral surface, as shown in Figs 4, 6 and 7. Continued use of both types of markings will serve to clarify the degree of change exhibited by either, with consequent improvements in the ability to estimate population size on the basis of photo-identification studies (Hammond, 1986).

We have received only four photographs of whales observed in Antarctic Area V to date. The fact that one of these turned out to be a whale subsequently identified in east Australian waters provides important support for the hypothesis that Area V humpback whales migrate to East Australia in the winter. Persistent efforts to photograph whales in the Antarctic, and continued photo-documentation of humpbacks in Australia, should lead to a much greater understanding of the complex movement patterns of humpback whales in the southern oceans.

ACKNOWLEDGEMENTS

This research was funded by the Pacific Whale Foundation and its members, and was conducted under permit from the Australian National Parks and Wildlife Service (Professor J.D. Ovington, Director). PWF Research Assistant Greg Krutzikowsky photographed the subject animal on Sept. 10. We thank Greg Krutzikowsky, Kim Furry and Curt Jenner for assistance in the field. We also thank Des McWilliams and Mark Nichols of NETWORK 10 for logistical support.

REFERENCES

- Allen, K. 1980. *Conservation and Management of Whales*. University of Washington, Seattle. i-ix+107pp.
- Baker, C.S., Herman, L.M., Perry, A., Lawton, W.S., Straley, J.M., Wolman, A.A., Kaufman, G.D., Winn, H.E., Hall, J.D., Reinke, J.M. and Ostman, J. 1986. Migratory movement and population structure of humpback whales (*Megaptera novaeangliae*) in the central and eastern North Pacific. *Mar. Ecol. (Prog. Ser.)* 31:105-19.
- Baker, C.S. and Herman, L.M. 1987. Alternative population estimates for humpback whales (*Megaptera novaeangliae*) in Hawaiian waters. *Can. J. Zool.* 65: 2,818-21.
- Bryden, M.M. 1982. Survey of humpback whales (*Megaptera novaeangliae*) off eastern Australia. Report to the Australian National Parks and Wildlife Service, Canberra City, Australia (unpublished).
- Carlson, C.A., Mayo, C.A. and Whitehead, H. 1990. Changes in the ventral fluke pattern of the humpback whale (*Megaptera novaeangliae*) and its effect on matching. Paper SC/A88/ID35 (published in this volume).
- Chittleborough, R.G. 1965. Dynamics of two populations of the humpback whale, *Megaptera novaeangliae* (Borowski). *Aus. J. Mar. Freshw. Res.* 16: 33-128.
- Darling, J.D. and Morowitz, H. 1986. Census of "Hawaiian" humpback whales (*Megaptera novaeangliae*) by individual identification. *Can. J. Zool.* 64:105-11.
- Dawbin, W.H. 1964. Movements of humpback whales marked in the southwest Pacific Ocean 1952 to 1962. *Norsk Hvalfangsttid.* 48:213-38.
- Glockner, D. and Venus, S.C. 1983. Identification, growth-rate, and behavior of humpback whale (*Megaptera novaeangliae*) cows and calves in the waters off Maui, Hawaii, 1977-1979. pp. 223-58. In: R. Payne (ed.) *Communication and Behavior of Whales*. AAAS Selected Symposium 76. Westview Press, Boulder, Colorado. 643pp.
- Hammond, P.S. 1986. Estimating the size of naturally marked whale populations using capture-recapture techniques. *Rep. int. Whal. Commn* (special issue 8): 253-82.
- Katona, S., Baxter, B., Brazier, O., Kraus, S., Perkins, J. and Whitehead, H. 1979. Identification of humpback whales by fluke photographs. pp. 33-44. In: H.E. Winn & B.L. Olla (eds.) *Behavior of Marine Mammals, Vol. 3. Cetaceans*. Plenum Press, New York.
- Kaufman, G.D. and Forestell, P.H. 1986. *Hawaii's Humpback Whales*. PWF Press: Kihei, Hawaii.
- Kaufman, G.D., Smultea, M.A. and Forestell, P.H. 1987. Use of lateral body pigmentation patterns for photographic identification of East Australian (Area V) humpback whales. *Cetus* 7:5-13.
- Omura, H. 1953. Biology study on the humpback whales in the Antarctic whaling areas IV and V. *Sci. Rep. Whal. Res. Inst., Tokyo.* 8:81-101.
- Perkins, J.S., Balcomb, K.C., Nichols, G., Hall, A.T., Smultea, M. and Thumser, N. 1985. Status of the West Greenland humpback whale feeding aggregation, 1981-1983. *Rep. int. Whal. Commn* 35: 379-83.
- Pike, G.C. 1953. Colour pattern of humpback whales from the coast of British Columbia. *J. Fish. Res. Bd Can.* 10:320-5.
- Rice, M., Carlson, C., Chu, K., Dolphin, W. and Whitehead, H. 1987. Are humpback whale population estimates being biased by sexual differences in fluking behavior? *Rep. int. Whal. Commn* 37:333-5.

Case Studies (by species)



Humpback whales, courtesy of Ken Balcomb

Population Size, Trends and Reproductive Parameters of Right Whales (*Eubalaena australis*) off Peninsula Valdes, Argentina

Roger Payne, Victoria Rowntree and Judith S. Perkins

Long Term Research Institute, 191 Weston Road, Lincoln, MA 01773, USA

Justin G. Cooke

Center for Long Term Ecosystem Management, Moos, D-7809 Winden 1, Federal Republic of Germany

and

Kees Lankester

1e Helmerstraat 183-111, 1054 DT Amsterdam, Netherlands

ABSTRACT

Photo-identification of individual whales, based on natural markings, has been used to study a population of southern right whales, *Eubalaena australis*, on their winter assembly grounds around Peninsula Valdes, Argentina. Right whales have raised patches of roughened skin (callosities) on their heads. The pattern of callosities differs between individuals. This enables known individuals to be monitored over time. Photographs of individual whales have been obtained from aerial surveys conducted each year between June and December from 1971 through 1986. A total of 909 distinct individuals were identified over the period, of which 481 were identified in more than one season. These data have been used to estimate various population parameters. The mean calving interval is estimated to be 3.6 years (95% confidence interval 3.3 to 4.1 years). It is estimated that there were 99 (SE 18) calvings in the population in 1986, which implies a total population of about 1,200 in that year. The population is estimated to be increasing at a rate of 7.6% p.a. (SE 1.7%). These estimates should be treated with caution until the validity of the underlying assumptions has been verified.

INTRODUCTION

Individual southern right whales (*Eubalaena australis*) can be identified by raised patches of roughened skin (callosities) on the dorsal surface of their heads. The number, size, shape and position of callosities differs among individuals and appears to undergo only minor changes over time; furthermore the variability in the patterns is sufficient in principle to uniquely identify each individual in a population of billions (Payne, Brazier, Dorsey, Perkins, Rowntree and Titus, 1983). Fig. 1 shows an example of a whale photographed in 1971 and again in 1986.

Natural markings such as these have a number of advantages over artificial marking of individuals as a means of studying populations, including: (i) they do not have to be installed (which saves both animals and biologists considerable stress); (ii) they are easily visible in the field at reasonably large distances, making collection of data feasible from aircraft, etc; (iii) since identification of the tag does not involve killing the animal as is the case for some artificial marks, e.g. Discovery marks, the same individual can be resighted many times during its life; (iv) they do not interfere with locomotion or behaviour; (v) they appear to be retained throughout life; (vi) they provide plenty of redundancy in confirming the identity of an individual; (vii) last but not least, they leave little doubt over the number of individuals effectively marked. The latter point is especially important with respect to population estimation, where a common problem with 'Discovery' tagging is to know how many animals have been effectively tagged (e.g. see Buckland and Duff, 1989). The 'tagging' of a naturally marked animal involves the taking of a photograph. For the purpose of a given piece of analysis, the effective number of tags placed is

simply the number of photographs of adequate quality received; the date and location of each photograph are the only additional information required. Thus it is feasible to perform an analysis on data gathered from a variety of sources even when the field data have not been collected in carefully controlled circumstances.

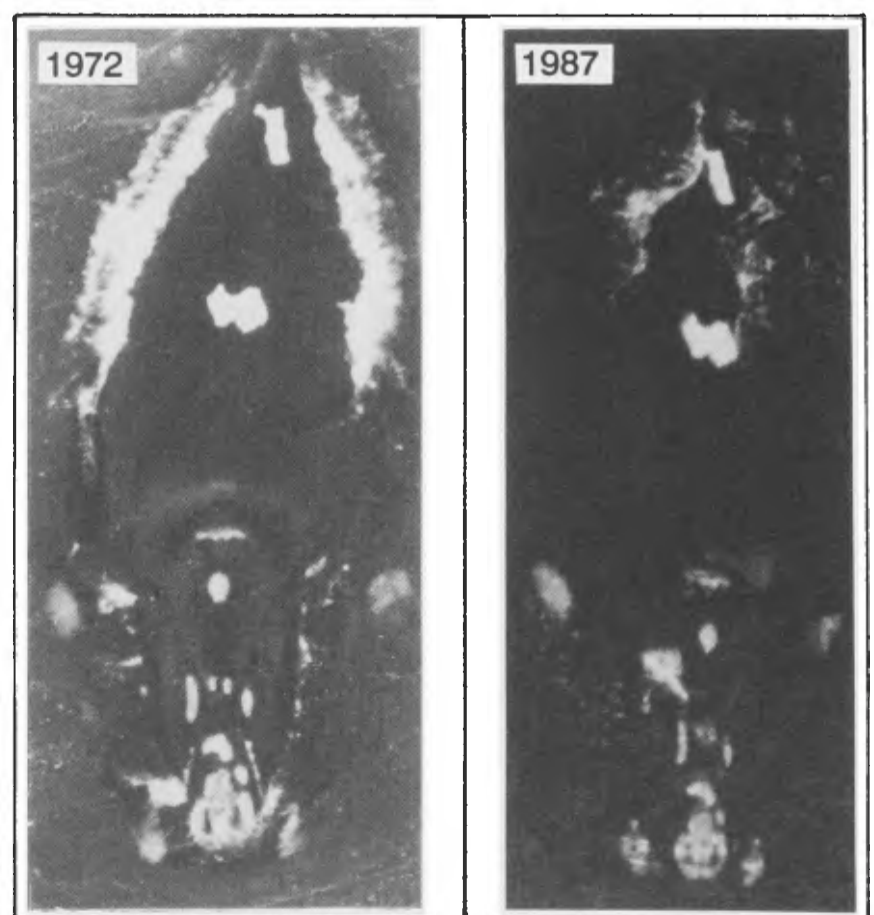

Fig. 1. Photographs of an individual taken in 1971, and the same individual photographed in 1986, showing the features used to identify the individual.

In the 18 years of this study, 909 individual whales have been identified and 481 have been identified in more than one season. In this paper, the data on identification and resightings of individuals are used to obtain preliminary estimates of some demographic parameters.

MATERIALS AND METHODS

Study site

The study site is the area surrounding Peninsula Valdes, Argentina (Fig. 2), where right whales are found between June and December every year. Calves are born there during this period. At the Peninsula, the whales concentrate along three different regions of the shoreline (Payne, 1986). We have collected data here every year since 1970 and the study is continuing. Between 1971–86, 87 aerial surveys were conducted during which individuals were photographed for identification. The number of flights per year has decreased during the course of the study, owing to the increasing cost of flying time. Fig. 3 shows the dates when flights were made. There was a minimum of two flights per year. The three regions in which the whales are most highly concentrated were surveyed at least once each year. There has been a tendency in recent years to focus survey effort on those areas where mother-calf pairs are common.

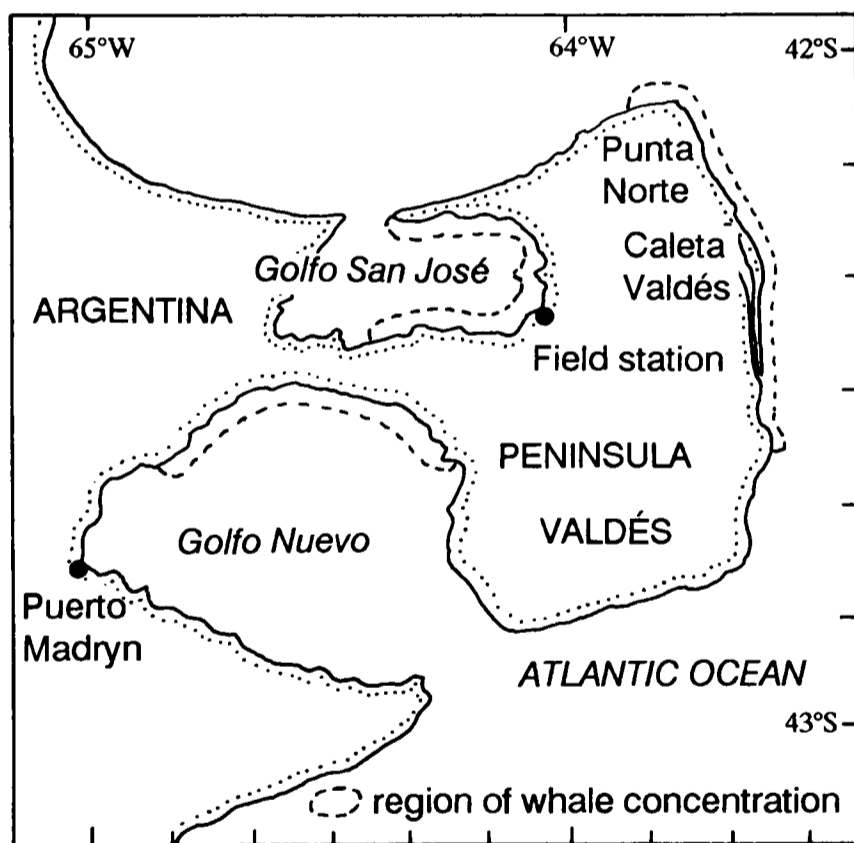

Fig. 2. Peninsula Valdes, Argentina showing, by hatching, the principal areas of right whale concentration from mid-June to mid-November. The New York Zoological Society field station from which studies are carried out is also indicated. (Taken from Payne *et al.*, 1983).

Aerial procedure and photography

Most airflights were made in a *Cessna* 182 single engine, high-wing aircraft. Most of the whales are found along the 5m depth contour (Payne, 1986), so that flights are usually within 2km of the tide line. There are a few whales in the middle of the bays, but flights over open water in a single engine plane are prohibited. The procedure is to fly at an altitude of 100–200m along the coast of the peninsula while searching for whales. When whales are sighted their location is recorded, the plane circles at 100m,

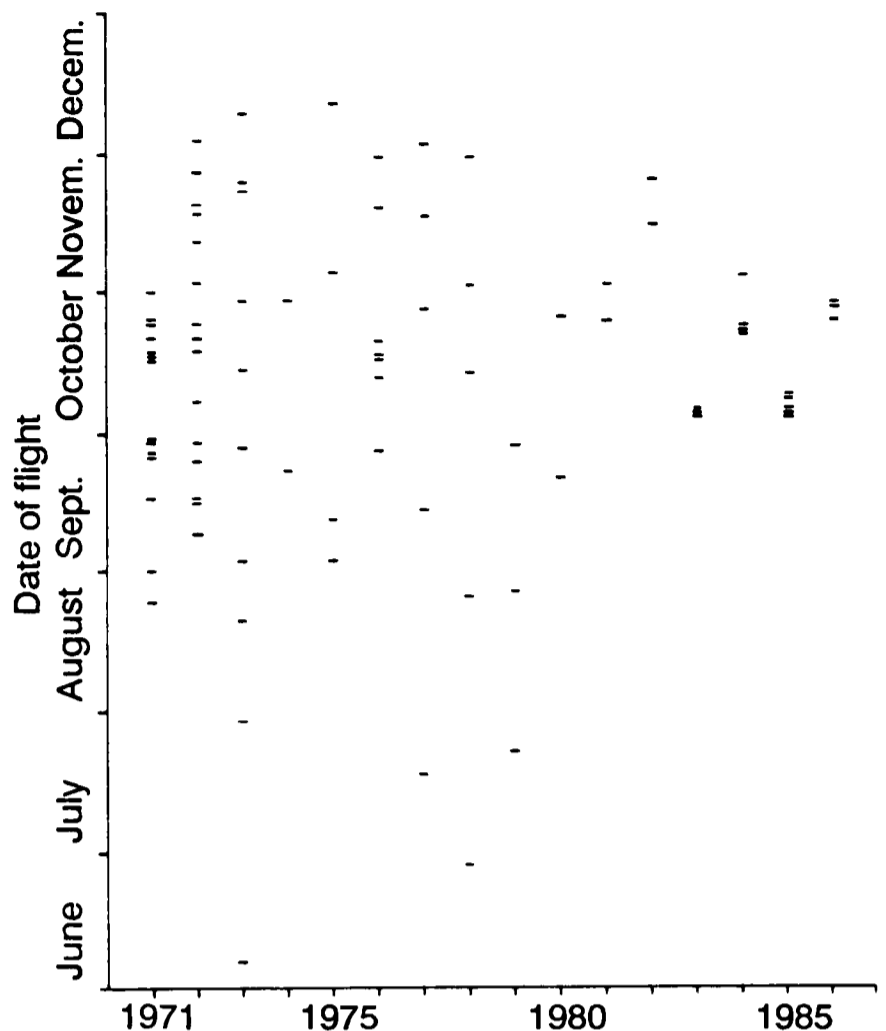

Fig. 3. Dates of each flight 1971–86.

photographs are taken and the number of whales seen determined and recorded. Usually most of the whales encountered are photographed. Some whales surface only briefly (those making a transit) or stay underwater for long periods of time. If, after 4 or 5 circles, we have been unable to obtain photographs, we abandon the whale.

Most photographs are taken at a shutter-speed of 1/500th of a second or faster, using 300mm lenses on motor driven 35mm single-lens reflex cameras. There is an unavoidable trade-off between the speed of the film (to compensate for vibrations in the airplane and occasional low light levels) and the fineness of its grain (to ensure as much detail as possible in the outline of the callosity-pattern). We have used both black and white film (*Kodak Plus-X*) and colour film (*Kodachrome 64* and *Ektachrome 200*). Callosities can more easily be distinguished from white-water splashes in colour images than in black and white, so in recent years we have used colour films exclusively. Some photographs were taken with a gyrostabilising unit attached to the base of the camera, but they were not of significantly higher quality than those taken with a hand-held camera.

The photographer sits behind the pilot so that they both look out of the same window; thus when the pilot maximises his view of the whales he does the same for the photographer. Whenever possible the closest approach is made such that the whale is head-on to the plane and the plane is between the sun and the whale. It is important to photograph the whales from in front because much of the callosity variability occurs at the anterior end of the rostrum and is less visible in a rear view. The best pictures are taken when the dorsal surface of the whale's head is above the water as the whale surfaces to breathe. Where possible we take several pictures of each individual, striving particularly for motor drive sequences in which the shutter release is depressed for several frames. This removes the inevitable motion of the camera when pressing and releasing the shutter and makes those pictures in the

middle of the motor drive sequences steadier than the first and last frames of the same sequence. Furthermore, the callosity pattern is often obscured partly or wholly by foam and/or specular reflections of sunlight. The pattern is also subject to distortion by refraction from overlying waves when seen through the water. By taking a series of photographs of the whale as it surfaces, identifications can be based on those features present in two or more photographs from different angles. After every sequence of photographs, a 'blank' is taken of some identifiable object to avoid ambiguity in later analysis.

Analysis of aerial photographs

The sequence of photographs of a whale's head is analysed to determine the pattern of its callosities. Once the pattern is determined, it is compared to the current collection of known whales, which is organised into a catalogue containing the best single photograph of the callosity pattern of each individual. In making a match it is often necessary to compare other photographs from files of the whale in the catalogue to the sequence of photographs of the individual in the film being analysed. In the initial film analysis, each whale photographed is recorded as being either (1) a match with a whale found in the catalogue, (2) a new whale not existing in the catalogue or (3) unidentifiable. All new whales in a year are compared with each other to determine that there are no duplicates. An identification as a match or a new whale is confirmed by another researcher experienced with right whale identification, and any conflicting opinions are resolved before an identification is accepted. New whales are then added to the catalogue. Each identification is graded on a scale of A (excellent) to D (marginal) for certainty of identity and the best photograph in each sequence of photographs of each whale is graded for quality of the photograph using the same scale.

One record is kept for each whale that has been identified. The record contains the whale's identification number from the catalogue, and, for each year in the study, the number of times the whale was identified, and whether it was accompanied by a calf. Occasionally the calf itself can be identified; these are recorded and provide a valuable, if small, sample of known-age individuals. However calves are usually difficult to identify in their first three months of life because the callosity area on the head is often obscured by a species of cyamid that is not confined to the callosity tissue. As a result only a minority of calves

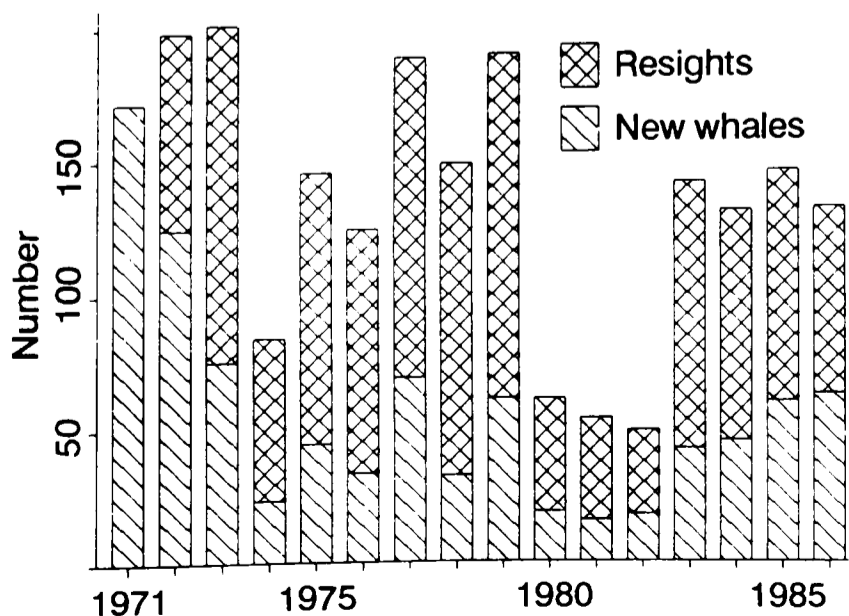

Fig. 4. Number of whales identified each year, divided into 'new' whales, and whales resighted from previous years.

can be entered into the catalogue in their year of birth. Fig. 4 shows the number of whales identified in each year, divided into 'new' whales and resightings of whales identified in previous years.

Each record also contains an indication of whether the animal is known to be male, female or if, as in about half the animals, the sex is unknown. The sexing method is described by Payne *et al.* (1983). As currently compiled, the data base does not indicate in which year the animal was sexed. Since the probability of sexing an animal is a function of the number of times it is seen, stratification of analyses by sex, where known, would result in an extremely complex problem of inference. Therefore, the sex information was not used in the analyses that follow.

ANALYSES AND RESULTS

Calving interval

Fig. 5 shows the distribution of observed apparent intervals between calvings. By far the most common inter-calf interval is three years; intervals less than this are rare. However, whales may not always be seen each year they have a calf and thus it is not clear how many of the longer intervals are 'real' and how many are the result of missed calvings. Furthermore, the large variation in annual sample sizes and the fact that we observe only a window in time, means that the apparent frequencies in Fig. 5 will be distorted by the unequal numbers of opportunities to observe different lengths of interval.

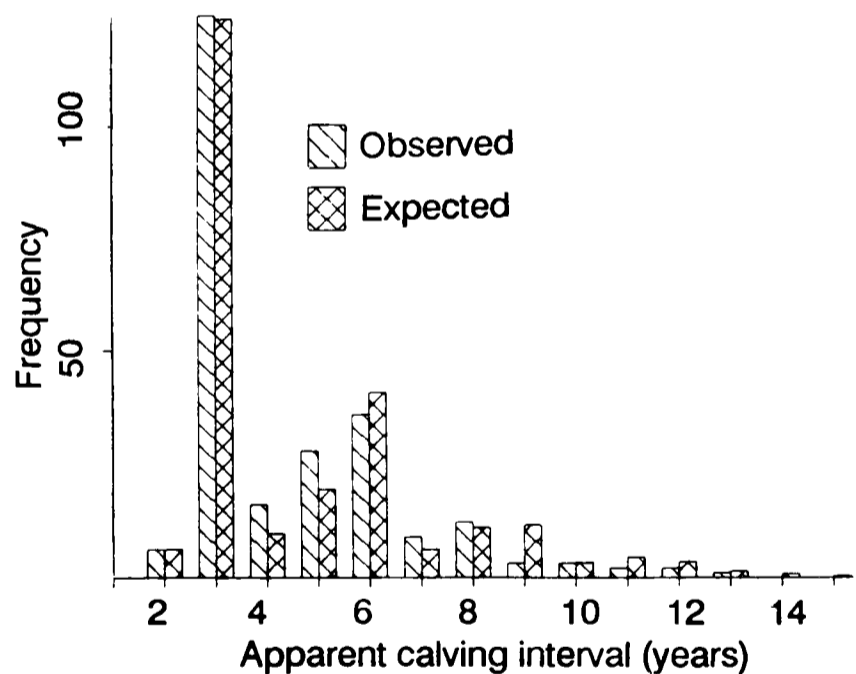

Fig. 5. The distribution of observed intervals between known calvings of individual whales. See Appendix for an explanation of the 'expected' distribution.

Barlow (1990) presents a method for estimating the frequency of different birth intervals in a population from photo-identification data. The method makes use of data on the years in which each identified whale was seen with a calf, and the years in which it was seen without a calf. It depends on the assumption that a given whale in a given year is equally likely to be seen whether or not it has a calf and that if it is seen in a year in which it has a calf, then it is also recorded as having a calf.

There are two major problems with using Barlow's method with these data: (1) as noted by Payne (1986), the breeding females in this population appear in the study area mainly in years when they have calves and less so in intervening years; and (2) it cannot be proved that calves

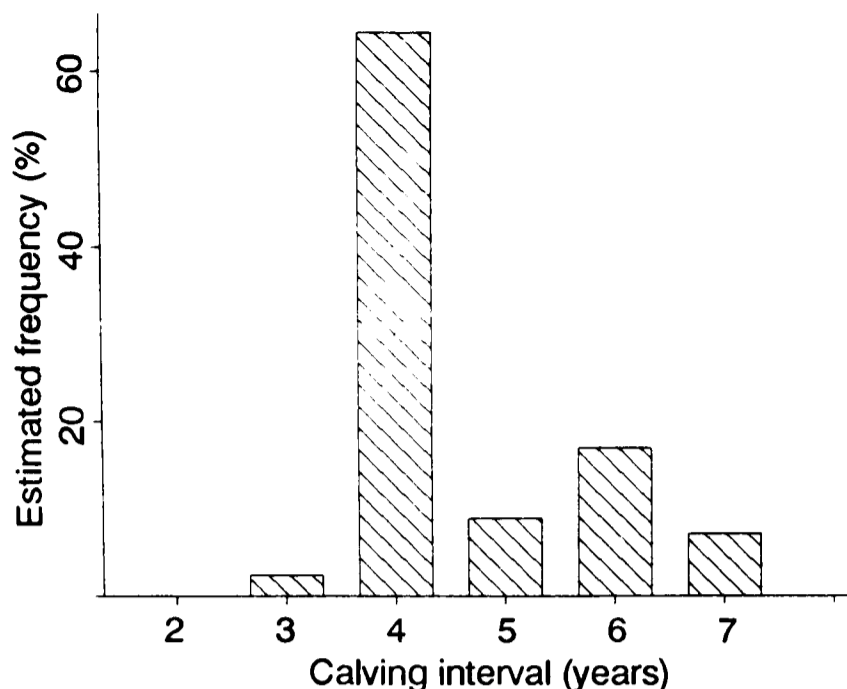

Fig. 6. Estimated relative probabilities of different inter-birth intervals for breeding females.

are always recorded even if the mother is seen. The event 'a calving is recorded' means that the mother is identified and is seen to be accompanied by a calf.

We therefore developed our own model for interpreting these data. This is described in the Appendix, it makes use only of identifications of whales with calves. The main assumptions of the model are that: (i) the probability that a random calving in a given year will be recorded is independent of whether that whale's previous calving was recorded; (ii) the probability that a whale will calve in a given year is a function only of the time elapsed since its preceding calving, if any, and not the time elapsed since calvings previous to the immediately preceding calving (i.e. successive calvings of an individual form a Markov chain). Further, less critical assumptions about survival rates are detailed in the Appendix.

Fig. 6 gives the resulting estimates of the relative frequency of different birth intervals. The mean calving interval is estimated at 3.63 years with a 95% confidence interval of 3.27 to 4.09.

Fig. 7 shows the observed ratio of calves to other whales sighted each year. There is a considerable increase in the proportion of calves over the period. While this may suggest an increase in the calving rate, it may also simply reflect a tendency to concentrate the sampling effort on the

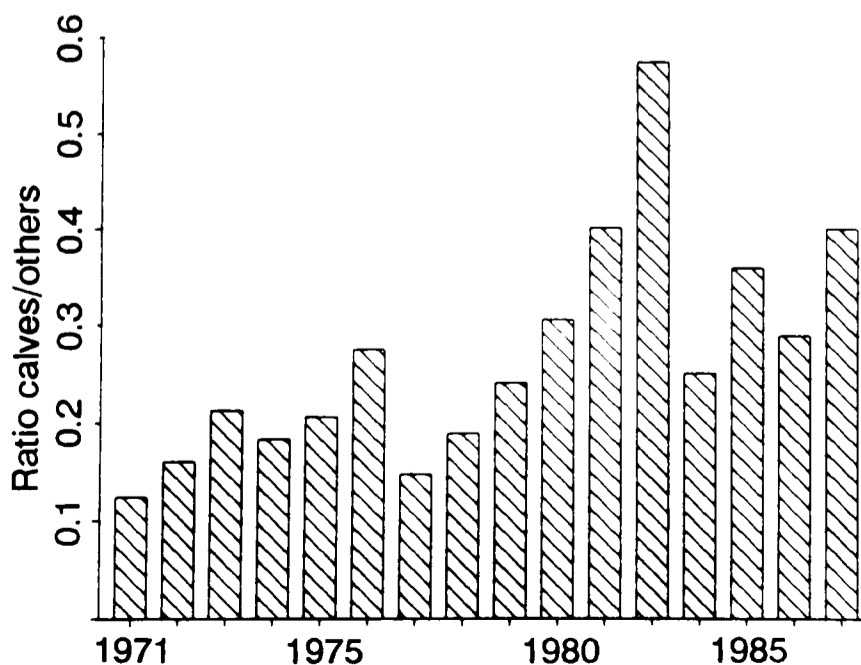

Fig. 7. Observed ratio of calves to identified non-calves by year.

areas or periods in which mother-calf pairs predominate in the later years. If the observation is due to a real increase in the calving rate, then this would imply a decrease in the mean calving interval. Since the bulk of calving intervals are in the range 3–5 years, one would expect a decrease in mean calving interval to be reflected in a tendency for 4- and 5-year intervals to become relatively less common with time compared with the 3-year intervals.

The analysis of the data for possible trends in these frequencies detailed in the Appendix reveals no significant trends. There is even a non-significant increasing trend in the relative frequency of 4- and 5-year intervals and hence in the mean calving interval. It can therefore be concluded that the apparent increase in calving rate is not real.

Age at first calving

As noted earlier, a small number of calves could be entered into the catalogue in their year of birth. This provides a sample of known age individuals from which information on the year of first calving can be obtained. Because new calves are being added to this sample every year there are relatively more observations of known age animals in younger than in older age classes. Surveys began in 1971 and thus the maximum known age in 1986 was 15 years.

Fig. 8 shows the distribution of age at first known calvings of known age individuals that have calved. The minimum age at first calving is 7 years. Because inter-calf intervals less than three years are rare, it can be assumed that the apparent first calvings at ages 8 and 9 are also genuine first calvings. Given that we estimate that about half the calvings in the later years have been missed (Fig. 10), some or possibly all of the remainder of apparent first calvings will be second or subsequent calvings.

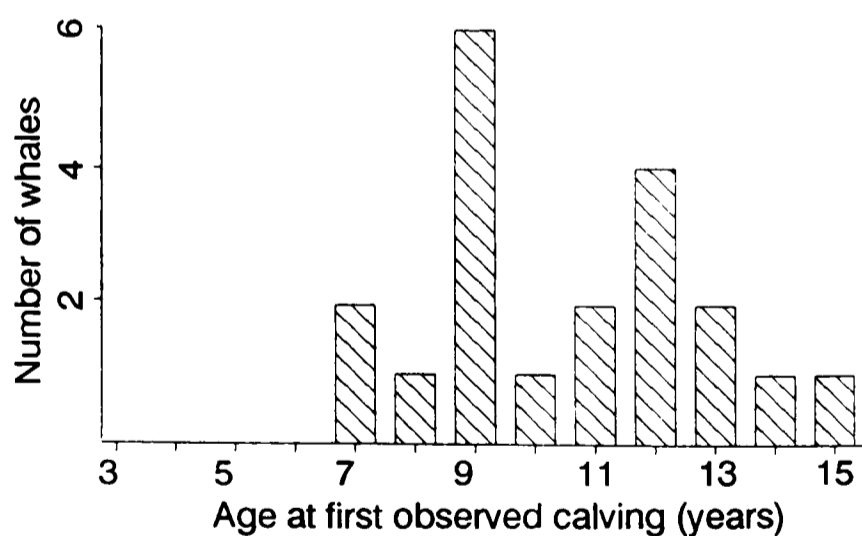

Fig. 8. Distribution of age at first known calving of known-age individuals.

The data suggest that the majority of first calvings may occur at 9 years of age, while the subsidiary peak at age 12 represents second calvings, but sample sizes are too small to draw any definitive conclusions. In principle a model could be developed to estimate the proportions of apparent first calvings at each age that are genuine, but in view of the small numbers it does not seem worth doing so at present.

Provided that the study is continued, sample sizes of known age animals in the key age classes will accumulate rapidly over the next few years, enabling more precise estimation of the mean age at first calving.

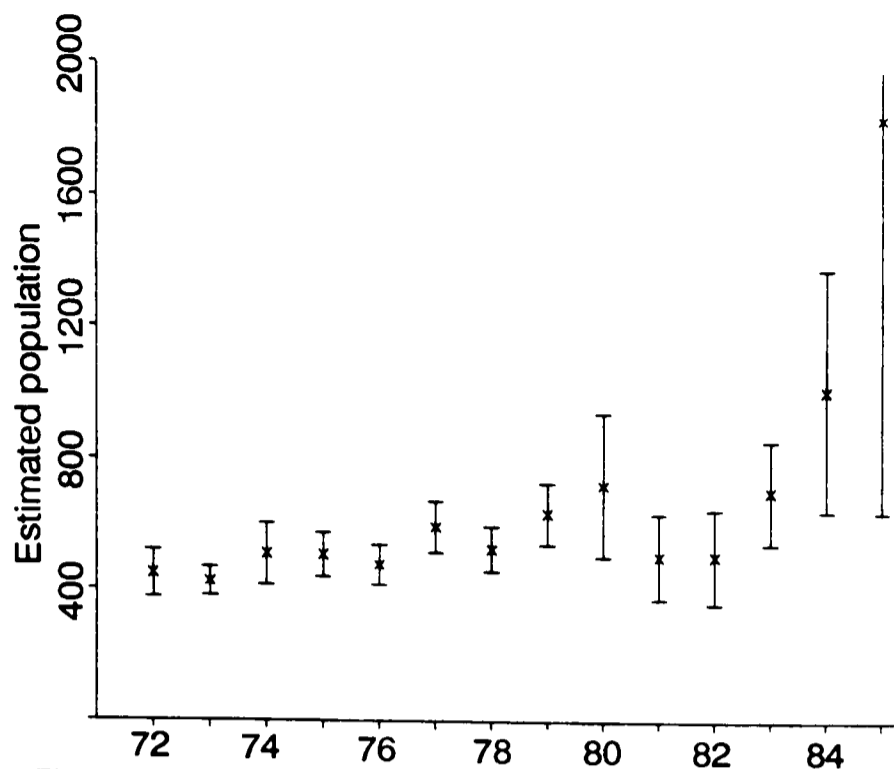

Fig. 9. Estimates of population size by year 1972–85 using the Jolly-Seber 3-sample method. Error bars are two estimated standard errors each side of the estimate (actual 95% confidence intervals would be asymmetric).

Population size and trends

Estimates of the total population size and the numbers of known females by year were obtained in an earlier paper from the first six years of this data set (Whitehead, Payne and Payne, 1986), using the Jolly-Seber three-sample method (Seber, 1982).

Updated estimates of the total population (excluding calves) using the same method are shown in Fig. 9. However, these estimates should be treated with caution, because some of the assumptions of the method are known to be violated. A key assumption of the method is that the probability that a random individual is sampled in a given year is independent of whether it was sampled in previous years.

Because the raw apparent calving rate of the population (Fig. 7) is greater than the calving rate implied by the estimated mean calving intervals in the preceding section, we know that the samples are biased towards calving females. Furthermore, this bias increases in the later years, so that estimates of trends in population size as well as estimates of absolute population size from the Jolly-Seber method will both be biased.

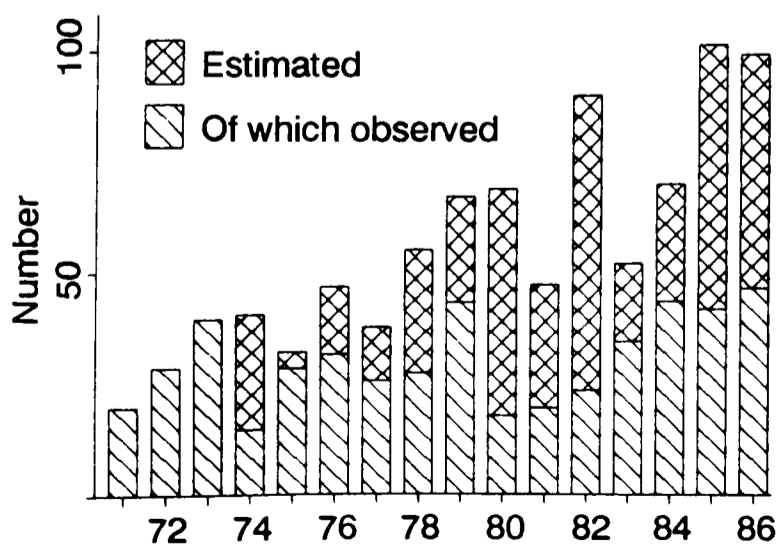

Fig. 10. Estimates of numbers of calvings occurring in the population by year 1974–86, using the method described in the Appendix. The portion of the estimated number that was actually observed in each year is also shown. No estimates are available for 1971–73: observed numbers only shown.

The reason why the estimates for the final two years are so much higher than the estimates for all other years is that the samples in the later years consist mainly of calving females which tend not to be resighted in the two years following a sighting. Since the population estimates are inversely related to the return rates, estimates of population size one or two years before the end of the data series will be biased upwards relative to previous estimates. This effect biases the trend in all other years to some extent, albeit less dramatically.

The tendency of females to return at 3-year intervals can also be viewed as a violation of the assumption of the Jolly-Seber method that animals do not emigrate from the population to return later.

If we restrict attention to the calving population, the method described in the Appendix, with its somewhat weaker assumptions, can be used. The estimated number of animals calving in each year using that method are shown in Table 1 and Fig. 10. Because the estimates are based on records of repeat calvings of females previously observed to calve, the method does not provide estimates for the first three years of the study.

Calculation of standard errors of these estimates is laborious and has only been done for the final (1986) estimate. Since the estimates in different years have considerable covariances, a simple regression of these estimates against time would not necessarily provide a valid estimate of the rate of change. The annual rate of change is estimated by the method described in the Appendix to be 7.6% (SE 1.7%).

Table 1

Observed and estimated number of calvings in the population.

Year	Obs.	Est.	SE	Year	Obs.	Est.	SE
1971	20	—	—	1979	44	66	—
1972	29	—	—	1980	18	69	—
1973	40	—	—	1981	20	48	—
1974	15	41	—	1982	24	90	—
1975	29	33	—	1983	35	52	—
1976	32	48	—	1984	44	70	—
1977	26	38	—	1985	42	101	—
1978	28	56	—	1986	47	99	18

DISCUSSION

Assumption (i) of the method may be violated in several ways. Firstly, the classification of photographs or photo-sequences of whales into 'match', 'new' and 'unidentifiable' is done in the following way: an attempt is made to match the photograph with one in the catalogue; if no match can be found, it is either entered into the catalogue as a new whale or discarded as unidentifiable. This procedure does not guarantee that whales that in reality match a whale in the catalogue are equally likely to be considered identifiable as are those which in reality are 'new' whales. Hence the assumption that the probability that a calving whale is identified in a given year is independent of whether it was identified in a previous year may not be justified. Secondly, some whales may be intrinsically more likely to be identified than others, due to their behaviour, calving date or migrational habits. To some extent this can be ascertained from the data themselves.

A further implicit assumption of the method is that all classifications of whale sightings into 'matches' and 'new' whales are correct. We have some evidence that some matching whales have been incorrectly classified as new, and it cannot be ruled out at this stage that some new whales have been incorrectly classified as matches. While the frequency of errors is thought to be low, a final judgement on this must await an appropriate analysis. Furthermore, the probability of errors of either type may be a function of catalogue size, since each new photograph or photo-sequence has to be compared with every whale in the catalogue. This could bias any apparent trends with time, such as the trend in population size.

The assumptions of the model are likely to be more seriously violated for the 'non-calving' segment of the population, because of its inhomogeneous composition. It comprises subadults of either sex, adult males, and adult females which have not yet been observed to calve. It would not be safe to assume *a priori* that the frequency of returns of subadults to the study area are independent of age. Hence no attempt has been made here to analyse these components of the population directly. It might be possible after recompilation of the data to perform analyses on subsets of the population of known status such as adult males. Otherwise, it may be necessary to wait until a larger sample of known age animals has accumulated.

If the mean age at first calving is 8.5 years then, assuming a stable age structure and a 50:50 sex ratio, we would expect 27% of the population to have had a calf if there is no mortality, and a lower proportion if there is mortality occurring. The estimate of 99 calvings in 1986 corresponds to an estimated population of females who have calved by 1986 of 320 assuming the estimated mean calving interval of 3.63 to be correct. (It is not a simple product of the numbers calving in 1986 and the mean calving interval, because of the effect of the increasing trend in the calving population.) This corresponds to a total population of 1,190 (more if mortality is occurring).

The calf production rate estimated from the mean inter-calf interval could generate an annual population growth rate of 7.6%, in the absence of immigration, only if the mortality rate is low enough. If mortality occurs equally at all ages, the annual rate would have to be less than 0.6%. If mortality occurs in the first year of life only, a value of up to 9.5% would be consistent with the observed rate of increase. A total of 12 dead calves have been observed during the period 1981–85, which places a lower bound on calf mortality of about 3%.

A low mortality rate does not necessarily imply an unreasonably long life span if the population is increasing. For example, even if no animal lived beyond 35 years of age, the annual mortality rate in a population with a stable age structure growing at an annual rate of 7.6% would be only 0.6% provided there was no mortality before this age. If it is growing as fast as it appears to be, the current population is too young to provide much information on lifespan.

The apparent rate of increase in the population could be exaggerated if there is net immigration from other calving areas in the southwest Atlantic, or if the interchange with other calving areas has been increasing even if there has been no net immigration. Furthermore, the possible biases

mentioned above relating to the identification process may also bias the apparent rate of increase especially if they are related to catalogue size. Thus the estimate should be regarded as provisional until these factors have been further investigated.

ACKNOWLEDGEMENTS

We gratefully acknowledge the help of friends during all phases of research described herein. In Argentina we received invaluable assistance from both institutions and individuals. Among institutions our deepest thanks go to the Fundacion Alfredo Fortabat, particularly Senora A. LaCroze de Fortabat; the New York Zoological Society, especially W. Conway; the Bernadino Rivadavia Museum of Natural Sciences, especially J.M. Gallardo; to the Chubut Department of Tourism, especially to A. Torrejon and J. Pepitone; and to the Fundacion Vida Silvestre, particularly M. Reynal and A. Lichter. We are grateful to the Government of Chubut and the Argentine Navy for making planes available. The Aero Club of Trelew made possible the regular flights from which the majority of data reported here were gathered. The individuals who gave us particular help are J. Bird, O. Brazier, H. Callejas, C. and J. Clark, E. Ferro, C. Garcia, J. and C. Gould, L. Guinee, G. and P. Harris, L. Leland Struhsaker, J.C. and D. Lopez, K. O'Connell, J. Olazabol, S. Ortega, T. and M. Ortiz-Basualdo, R. Osinalde, K. Payne, J. Perez Macchi, A. and A. Pereyra-Iraola, S. Tabor, P. Thomas, A. Torrejon, B. and M. Wursig and several anonymous reviewers. E. Dorsey and J. Seger helped in many aspects of this paper, including the analysis.

This research was supported by grants from the Fundacion Alfredo Fortabat, the National Geographic Society, the New York Zoological Society, the People's Trust for Endangered Species and the World Wildlife Fund-US; and by a contract with the Marine Mammal Commission (No. MM6ACO17).

REFERENCES

- Barlow, J. 1990. A birth-interval model for estimating age at first calving and mean calving interval. Paper SC/A88/ID6. (Published in this volume).
- Nelder, J.A. and Wedderburn, R.W.M. 1972. Generalised linear models. *J. R. Stat. Soc. A.* 135: 370–84.
- Payne, R. 1986. Long term behavioural studies of the southern right whale (*Eubalaena australis*). *Rep. int. Whal. Commn* (special issue 10): 161–7.
- Payne, R., Brazier, O., Dorsey, E., Perkins, J., Rowntree, V. and Titus, A. 1983. External features in southern right whales (*Eubalaena australis*) and their use in identifying individuals. pp. 371–445. In: R. Payne (ed.) *Communication and Behavior of Whales* AAAS Selected Symposia Series 76. Westview Press, Boulder, Colorado. 643pp.
- Sandland, R.L. and Cormack, R.M. 1984. Statistical inference for Poisson and multinomial models for capture-recapture experiments. *Biometrika* 71(1): 27–33.
- Seber, G.A.F. 1982. *The Estimation of Animal Abundance and Related Parameters*. Griffin, London. 2nd Edition, 654pp.
- Whitehead, H., Payne, R. and Payne, M. 1986. Population estimate for the right whales off Peninsula Valdes, Argentina, 1971–76. *Rep. int. Whal. Commn* (special issue 10): 169–71.

Appendix

A MODEL FOR ESTIMATING CALVING INTERVALS AND RELATED PARAMETERS

Let p_j be the probability that a calving in year j is recorded and h_j be the probability that a female that calved in year m will have its next calf in year $m+j$, conditional on its survival to year $m+j$. Let j_{max} be the maximum calving interval, so that:

$$\sum_{j=1}^{j_{max}} h_j = 1$$

Let q_j be the probability that a whale which calved in year m also calves in year $m+j$, conditional on its survival to year $m+j$. The q_j are related to the h_j by the relations:

$$q_j = \sum_{i=1}^j h_i q_{j-i}$$

where $q_0 = 1$.

Conditional on n_i , the number of calvings recorded in year i , the expectation of n_{ij} , the number of whales recorded to calve both in year i and in year j , is:

$$E(n_{ij}) = n_i p_j q_{j-i} s_{j-i} \quad (j > i) \quad (1)$$

where s_k is the probability that a whale calving in year m survives to year $m+k$.

To simplify the calculations, the model can be fitted as if the n_{ij} had a Poisson distribution about their expectation, even though this leads in theory to some overestimation of variance compared with the more realistic binomial model (Sandland and Cormack, 1984).

The following assumptions are implicit in the model:

- (i) the probability that a calving of a randomly selected individual in a given year will be recorded is independent of whether that individual's previous calving was recorded;
- (ii) the probability that the interval between a given calving of a given individual and the next calving of that individual, if any, will be of a given length is independent of the length of the interval between the given calving and the previous calving, if any;
- (iii) the relative probabilities of calving intervals of each length do not change with time;
- (iv) survival probabilities of females are not affected by calvings and do not change with time.

Table 2

Estimated probability distributions of calving intervals for different assumptions about the maximum calving interval.

Interval (years)	Assumed maximum interval (years)			
	4	5	6	7
1	0.00	0.00	0.00	0.00
2	0.13	0.03	0.02	0.02
3	0.80	0.73	0.65	0.65
4	0.07	0.08	0.08	0.08
5	—	0.16	0.17	0.17
6	—	—	0.08	0.08
7	—	—	—	0.00
Mean calving interval	2.94	3.39	3.63	3.63
Relative likelihood	0.00001	0.70	1.00	1.00
Verdict	reject	accept	accept	accept

The above formulation yields a series of nested models according to the value chosen for j_{max} , the maximum calving interval. Calculations were conducted for $j_{max} = 4, 5, 6$ and 7 . Table 2 shows the estimated h_j for each of the four models, on the assumption that survival rates are all unity.

While the relative likelihoods of such models should not be interpreted too literally, it is clear that the model with $j_{max} = 4$ is rejected. This is largely because there are too few 2-year intervals to adequately explain the relatively higher number of 5-year intervals in terms of sequences of 2 and 3-year intervals with a missed calving. The model with $j_{max} = 5$ is not rejected. The model with $j_{max} = 7$ led to exactly the same estimates of the h_j as the model with $j_{max} = 6$, because in the former model the estimate of h_7 was zero.

Fig. 5 shows the expected distribution of apparent inter-calf intervals from the models with $j_{max} = 6$ or 7 . The model seems to have some trouble fitting the large number of 4 and 5-year intervals and the relative paucity of 9-year intervals.

Due to the non-linear nature of the model and the complex covariance structure of the estimates of the h_j , individual standard error estimates for each of the h_j would not be particularly meaningful and have not been calculated. The mean calving interval is given by:

$$\sum_{j=1}^{j_{max}} j \cdot h_j s_j / \sum_{j=1}^{j_{max}} s_j$$

For the model with $j_{max} = 6$, the estimate of the mean calving interval is 3.63. The 95% confidence interval based on the likelihood ratio criterion is 3.77 to 4.09.

In principle, the survival rate can be estimated along with the h_j . The best estimate of the annual mortality rate using the model with $j_{max} = 6$ is approximately 0.01, but a zero value is not rejected at the 95% level. The upper 95% confidence limit is approximately 0.05. It can be concluded that such data are not sufficient for the estimation of the natural mortality rate. Natural mortality is reflected in such data as a tendency for the resighting rate to decay with time elapsed since the previous sighting. In this case, any apparent decay is confounded with the pattern of calf interval probabilities and is therefore difficult to detect.

There is a positive correlation between the value assumed for the natural mortality rate and the estimated mean calving interval. Hence the above estimate obtained with the assumption that the mortality rate is zero is in that respect a minimum estimate. Using the estimated value of M (0.01) changes the estimate of mean calving interval to 3.65 years, while using the upper confidence limit for M (0.05) increases the estimated mean calving interval to 3.77 years.

Numbers of calvings by year and trends over time

As a by-product, the fitted model (1) provides estimates of the p_j , the probability of recording a calving occurring in year j . These yield the estimators of the numbers of calvings in each year, N_j , given overleaf:

$$\hat{N}_j = n_j / \hat{p}_j$$

$$\text{where } \hat{p}_j = \frac{\sum_{i=0}^{j-1} n_{ij}}{\sum_{i=0}^{j-1} n_i q_{j-i} s_{j-i}}$$

The method yields no estimate of N_0 , the number of calvings in the first year of the study. Since there are no observed 1-year calving intervals in this data set, the method yields no estimate of N_1 either. Because there are so few two-year calving intervals, no meaningful estimate of N_2 is obtained. The remaining estimates are listed in Table 1. Because the estimates have considerable covariance, the simple procedure of regressing these estimates against time would not necessarily provide a valid estimate of the trend in the calving population size. A trend in the calving population size can be estimated with the following model:

Let $N_j = N_0 \cdot \exp(\delta \cdot j)$, where δ is the annual rate of increase expressed as an instantaneous rate. We can then fit the model:

$$E(n_{ij}) = n_i n_j \exp(-\delta \cdot j) q_{j-i} s_{j-i} / N_0 \quad (j > i)$$

Provided that we require only an estimate of δ and not of N_0 , we can fit this model directly, treating the q_j as nuisance parameters, without having to go via the h_j . The s_j and N_0 can be absorbed into the q_j parameters without changing the structure of the model. Thus for the purpose of estimating δ we do not need to assume a value for the natural mortality rate nor do we need to assume a value for

the maximum calving interval. The model is in the standard log-linear form, for the fitting of which various algorithms such as GLIM (Nelder and Wedderburn, 1972) are available. The estimate of δ is 0.073 (SE 0.017). This corresponds to an annual rate of increase of 7.6% p.a. (SE 1.7%).

Detection of trends in the mean calving interval

We note that since the h_1 and h_2 probabilities are zero or small, probabilities q_1 through q_5 are very close to the corresponding h values. Furthermore, the bulk of calving intervals are five years or less. Thus any trend in the mean calving interval will be reflected in terms of a trend in the relative values of the q_3 , q_4 or q_5 over time. We restrict attention to intervals of 3, 4 and 5 years inclusive and fit the model:

$$E(n_{i,j}) = n_i q_{j-i} p_j$$

where $q_{ij} = q_{i0} \exp(j \cdot \delta_i)$ ($i = 3, 4, 5$)

Again, we can work with the q_j 's alone without invoking the h_j and so without needing to assume a value for the natural mortality rate.

δ_i is the time trend in the frequency of calving intervals of length i . Because of the relative smaller size of the sample of 4 and 5 year intervals, we estimated a common value for δ_4 and δ_5 . Since there is one degree of redundancy between the δ_i and the p_j , one of the δ_i (say $\delta_{4,5}$) can be set to zero without loss of generality. This leaves only δ_3 to estimate. The estimate was -0.018 (SE 0.052). The negative sign implies a tendency for 3-year intervals to get less common relative to 4- and 5-year intervals with time, i.e. for calving intervals to get longer, but the trend is not significant.

Southern Right Whales off Western Australia

J.L. Bannister

The Western Australian Museum, Perth, Western Australia 6000

ABSTRACT

Southern right whale aerial counts and head callosity photographs from southern Western Australia, over some eleven years to 1987, have provided information on: a significant population increase, at least in cow-calf pairs; differences in some body characters (lip callosities, some body markings) compared with animals off South Africa and Argentina; patterns of distribution and dispersal along the coast; and reproduction (most mating activity unlikely to be taking place on the coast, one animal first seen as a probable yearling giving birth nine years later, calving interval averaging three years). Up to 81 individuals (including 21 calves) have been identified in one year along some 1,100km of coastline.

INTRODUCTION

Aerial surveys for southern right whales (*Eubalaena australis*) have been undertaken off southern Western Australia since 1976. Bannister (1986a) gave details of methodology, area covered and results obtained to 1982. As well as providing information on numbers, distribution, and relative abundance since 1980, a routine photographic record has been made, for identification of as many individuals as possible, using head callosity patterns and body markings, as developed by Payne and his colleagues (Payne, Brazier, Dorsey, Perkins, Rowntree and Titus, 1983).

The Western Australian work grew out of a programme of aerial survey originally designed to monitor the extent of recovery of right whales off the southwestern coast of the State. That area (the Coast of New Holland Ground) supported a right whale fishery in the early 1800s, both from pelagic vessels and shore stations. Both kinds of operation relied on the animals' habit of approaching the coast in the Southern Hemisphere winter and spring (July-October).

The effect of the coastal fishery together with offshore catching in the warmer months (October-January), was extreme stock depletion over a short period. The main shore-based activity off southwestern Australia lasted only 30 years (1836-66) and pelagic whalers concentrated on the area for only a third of that time, between about 1838 and 1849 (Bannister, 1986b).

The result was that by the early 1900s a right whale had become a very rare sight. Not until the mid 1950s was a twentieth century Australian sighting recorded in the literature, involving a cow and calf seen in 1955 off Albany (35°00'S, 117°52'E) (Chittleborough, 1956).

Increasing numbers of right whale reports from the 1960s off southwestern Australia, coupled with encouraging results from South America and South Africa, led to the continuing programme of annual aerial surveys that began in 1976.

This paper includes information from data available to 1987, in particular on body characters (including head callosities and dorsal body markings), distribution patterns, increase in numbers and calving interval.

DATA COLLECTION

Sampling strategy

Initially, the flight path was designed to examine the distribution of animals very close to the coast in winter/spring, in the area from which up to that time most reports had been obtained. That area extended along some 500 n.miles (900km) of the southern coast between Cape Leeuwin (34°22'S, 115°08'E) in the west and Israelite Bay (33°37'S, 123°55'E) in the east. In some years flights have continued up the west coast towards Perth (31°57'S, 115°51'E); since 1985 they have, whenever possible, been extended eastwards towards Twilight Cove (32°16'S, 126°02'E) at the western end of the Great Australian Bight. The maximum area covered, along some 600 n.miles (1,100 km) is shown in Fig. 1.

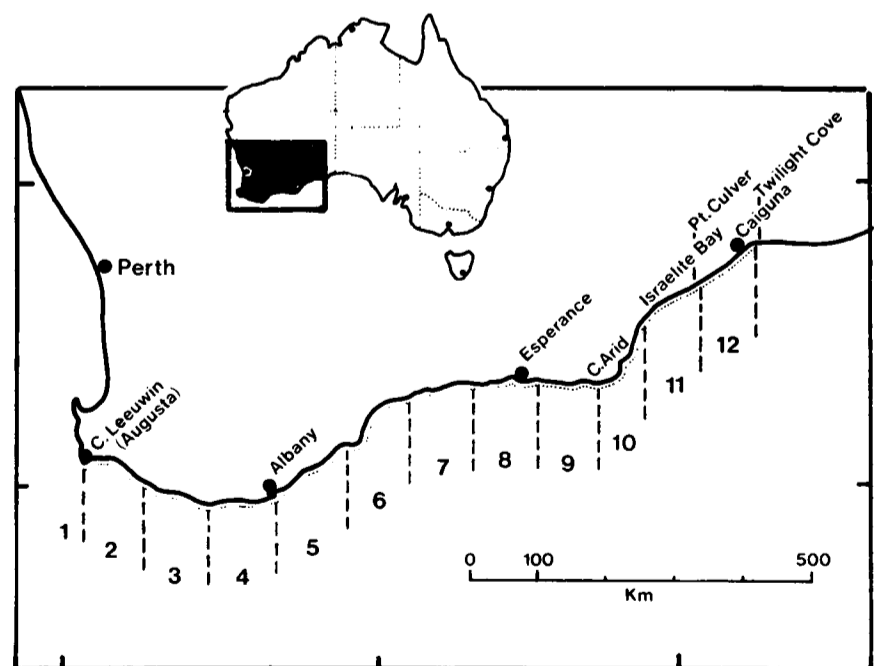

Fig. 1. Flight path, Western Australia 1976-87; also showing 50 n.mile distributional 'blocks'.

Flights follow the coastline in a highwing monoplane flying at 1,500 ft and approximately 100 knots. Prior to 1986 a *Cessna 172* was used; in that year it was replaced by a *Cessna 185*. The plane is flown virtually along the beachline. Searching is conducted mainly seawards throughout the flight, in a narrow zone from the beach

beyond the breakers to not more than 1 n.mile from the coastline. Flights are only begun when there is likelihood of 'good' weather, involving winds of less than 15 knots, calm to low swell and good to excellent visibility.

When whales are encountered, a count is taken from 1500 ft, and they are then circled at between 300 and 600 ft, for confirmation of numbers present and photography. The plane is generally crewed by two, a pilot/observer and an observer/photographer, both based at Albany (35°00'S, 117°52'E). The same two have flown on virtually all flights since 1980. The pilot (J. Bell) is extremely experienced, having been a whaling company spotter pilot since 1963, originally looking for humpback whales near the coast and sperm whales further offshore.

In recent years, attempts have been made to undertake two complete flights in each month from July to October. Their completion is not always possible, depending on a happy combination of availability – of pilot, of photographer, of good weather and of funds. In 1987, for example, only one flight in each month from August to October was possible because of funding constraints.

A 'typical' flight now occupies three days, as follows:

Day 1: Albany to Cape Leeuwin and return (about 4 hours)

Day 2: Albany to Twilight Cove (about 6 hours), overnight at Caiguna (32°16'S, 125°28'E)

Day 3: Twilight Cove to Albany (about 6 hours).

In 1984, a flight was undertaken along the whole of the Australian south coast, from Cape Leeuwin, around the Great Australian Bight and along the South Australian, Victorian and New South Wales coasts to Sydney. Since 1983 surveys similar to those off Western Australia have been conducted along the coast of South Australia. Since 1986 they have been planned to link up with those off Western Australia, overlapping at Twilight Cove.

Essentially, then, the aim off Western Australia has been to obtain information on the numbers, distribution and identity of animals close to the coast from at least one, and possibly two, complete flights in good weather along the whole flight path in each month during the period when major concentrations of animals are expected on the coast, i.e. July to October. Through operational constraints, that has been reduced most recently to one good flight in each month from August to October. Nevertheless that period covers the time when right whales have been recorded most frequently in the area, i.e. August and September (Bannister, 1986a).

Photographic techniques

Photographs are taken by the photographer/observer (R. Smith) using a hand-held *Bronica* 4.5 x 6cm format camera with motor drive and 250mm lens, on 200 ASA *Ektachrome* professional film through the open window of the aircraft. Up to five shots may be taken of an individual, with the object of providing as good a set as possible of photographs of the dorsal surface of the whale's head and of any dorsal body markings.

The pilot manoeuvres the aircraft so that the whale is on the circumference of a circle and circles it as required by the photographer. This allows a shot to be taken directly over the whale, with the top of its head parallel to the focal plane of the camera. That cannot be achieved if the whale is at the centre of the circle described by the aircraft. Shots are only taken when the aircraft is directly over the whale, with the sun behind the aircraft.

The photographer/observer relates the film and frame number to the whales recorded on a standardised log sheet maintained by the pilot. The processed film is then forwarded to the author together with the flight log sheets.

The author reviews each frame, and mounts those where the shots are likely to be useful in identifying an animal. They are mounted as 2" x 2" glass slides and projected on a *Simon SVS5822* table top viewer. Tracings of callosity patterns at x8 or x22 magnification are transferred to punched file cards for later sorting, together with observations on body markings, class of whale (calf, cow-calf pair, unaccompanied adult etc.), date, location and other comments. Each slide is identified by a number which combines the date, the whale number noted by the photographer and the frame number. Each file card represents a single individual, except where the calf of a cow-calf pair cannot be individually identified, which is usually the case.

At present, all file cards are retained where the tracing derived from a photograph allows a callosity pattern to be recognised, or where a well-defined body marking is present.

REIDENTIFYING INDIVIDUALS

Initial sorting uses the tracing of the head callosity pattern on the punched card. Features used in identifying the callosity pattern are shown in Fig. 2. As elsewhere (e.g. Payne *et al.*, 1983; Best, in press), the presence/absence and extent of the lip patches, and the presence and pattern of rostral islands, have been found most useful for identifying individuals. Again as elsewhere, other callosities (bonnet, post blowhole island) seem always to be present. The coaming is almost always present (it is absent in only one Western Australian individual to date).

'Matching' of individuals is first undertaken on the presence or absence of lip patches, as in Best (in press) but in contrast to Payne *et al.* (1983) who sort first on the posterior margin of the bonnet.

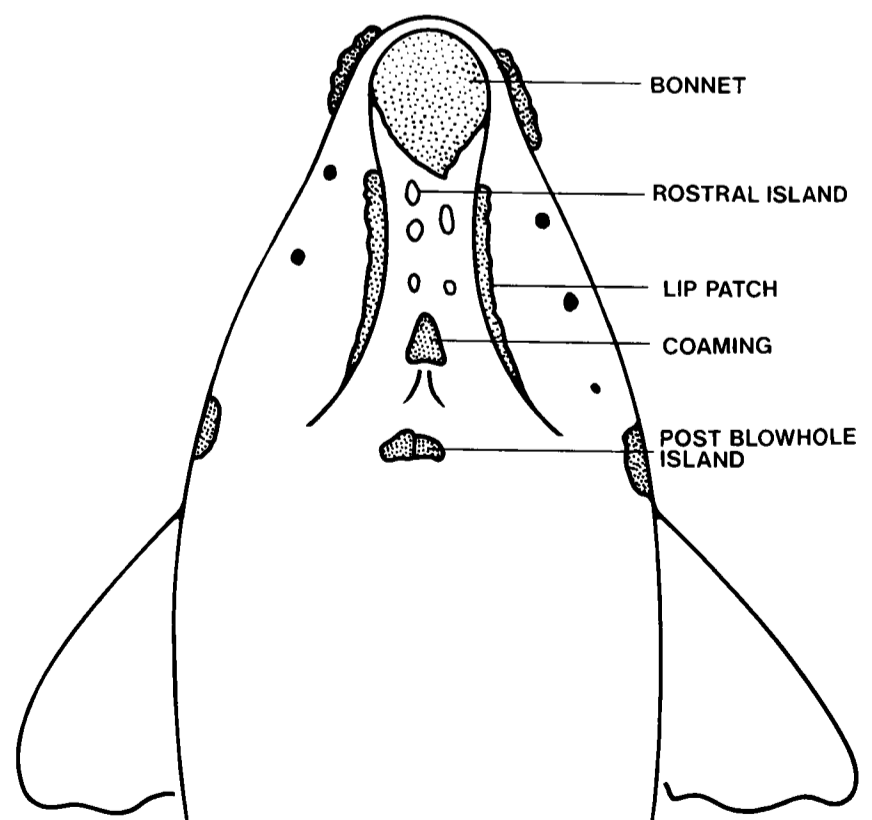

Fig. 2. Southern right whale. Dorsal surface of head, showing callosities used in identification of individuals (Match 26, based on Payne and Rowntree, 1984).

Once a potential 'match' has been identified from the tracing on the file card, the original photographic slides from which the tracings were taken are examined. Only after exhaustive comparison of those photographs is a 'match' confirmed.

Payne *et al.* (1983) have demonstrated the persistence of callosity patterns over time. Such persistence has now been recorded in the Western Australian data for up to eight years. Some examples of persistent patterns are given in Fig. 3.

The callosity patterns seen in Western Australian animals are generally similar to those described from other Southern Hemisphere localities, i.e. South Africa and Argentina. However, two animals have approached the condition recorded for the Northern Hemisphere, where in nearly half of the photographed population there is a more or less continuous callosity from the bonnet to the coaming (Kraus *et al.*, 1986). One of the Western Australian examples is shown in Fig. 4.

The punched card index (as at April 1988) contains 453 cards, as given below.

- (1) 232 cards representing 73 'matches' i.e. individuals identified more than once, either within or between years. The adults represented by those matches were accompanied by 63 calves. Each calf is recorded on its respective 'adult' card unless identified individually.
- (2) 221 cards representing 220 individual adults ('non-matches'), accompanied by 79 calves, and including one card representing a single calf.

The above represents 293 adults and 143 calves, i.e. 436 individuals. Given that the non-matches probably include a few unidentified matches, that figure is likely to be an overestimate, although not a large one, of the number of individuals involved.

In addition to head callosities, three kinds of natural body marking have been found useful for identifying individuals over time. As described by Best (1985) these comprise white dorsal blazes, partial albinism and grey

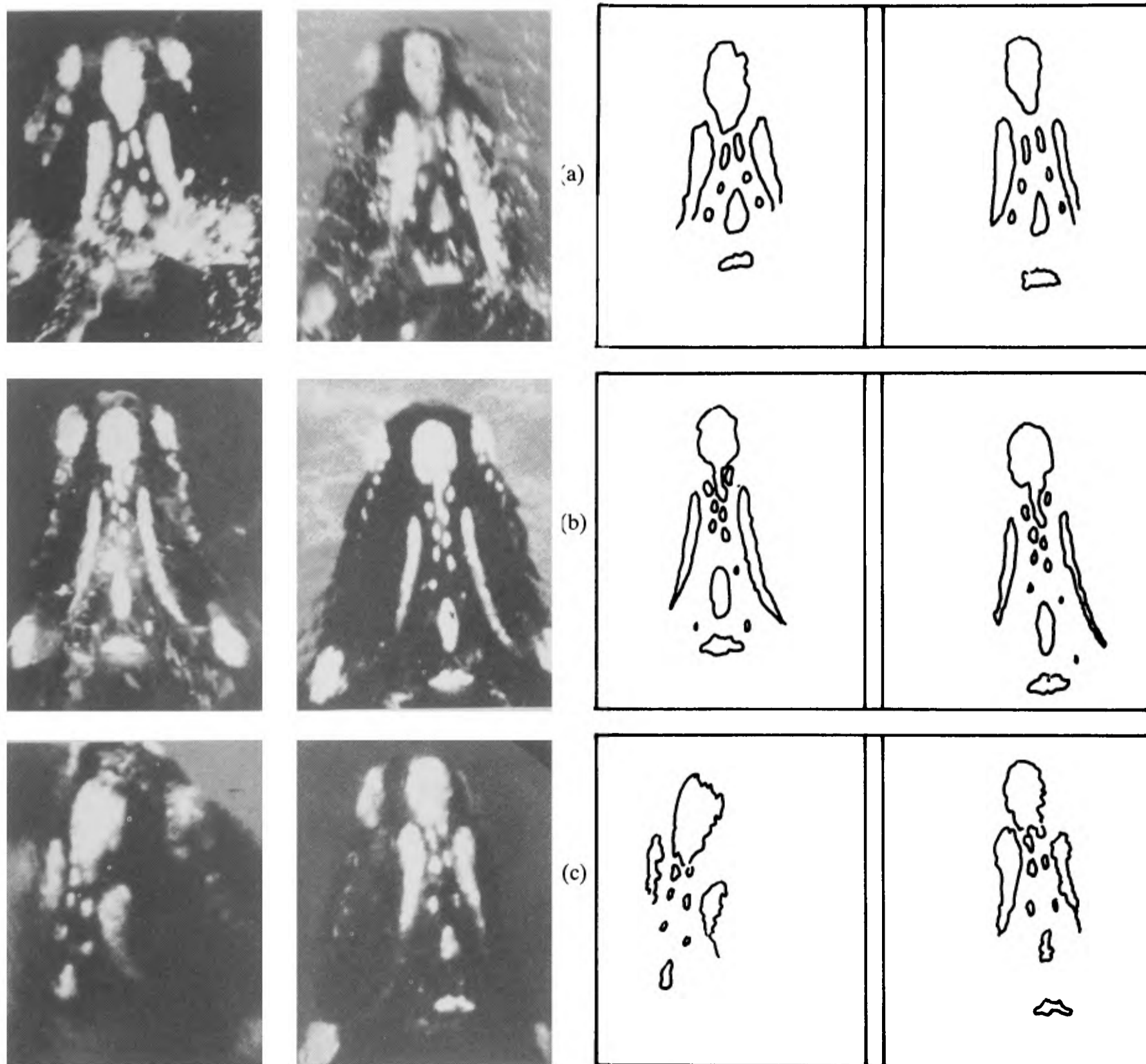

Fig. 3. Examples of consistency in callosity patterns; Western Australia, 1982-87. (a) Match 20: i - 1982; ii - 1987. (b) Match 24: i - 1982; ii - 1987. (c) Match 27: i - 1982; ii - 1986.

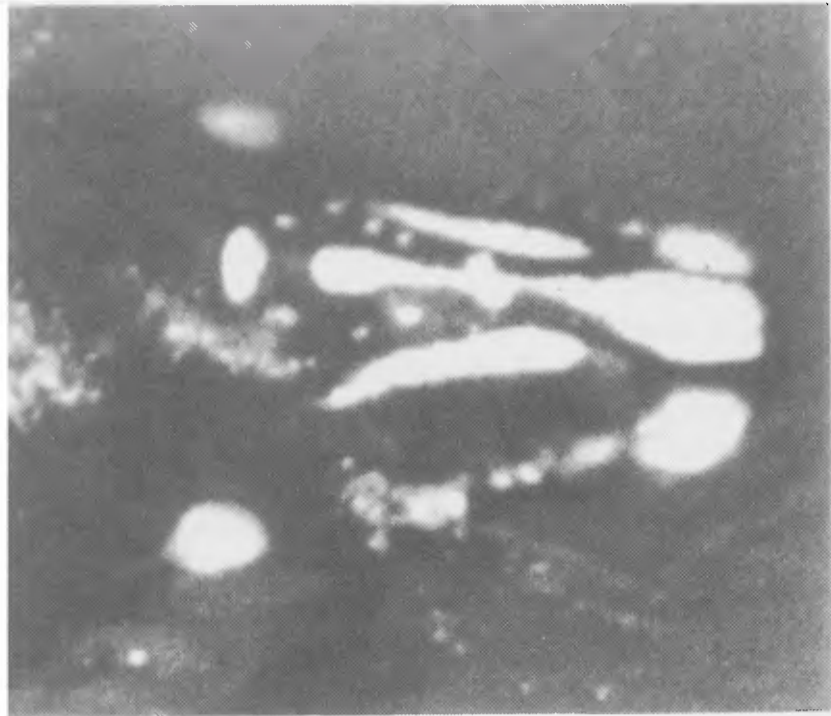

Fig. 4. A Western Australian 'Northern Hemisphere' callosity pattern (Match 39, 1985).

dorsal blazes. All three have been used to identify individuals off Western Australia. Their persistence over time is well demonstrated in several individuals; for example, one animal (Match 17), first recognised by a distinctively - shaped white dorsal blaze in 1976, has been resighted since in 1981, 1984 and 1987. Their usefulness in confirming the persistence of head callosity patterns can also be demonstrated from the Western Australian data. In Match 17, for example, where the callosity pattern was first photographed in 1981, that pattern has been retained over the years to 1987.

SPATIAL AND TEMPORAL DISTRIBUTION

Population differentiation

Demonstrated differences in frequency of callosity patterns or body markings from separate localities can be taken to suggest that the animals in those localities may belong to separate populations. Some comparisons are now possible for data from Western Australia, South Africa and South America.

There is a highly significant lack of homogeneity among the frequencies of lip patches from the three areas (chi-square=24.57, 4df, $p < 0.005$). The frequencies are given in Table 1. Best (in press) found no significant difference between South Africa and Argentina in this respect, but there is a highly significant difference between Western Australia and South Africa (chi-square=17.39, 2df, $p < 0.005$). As in the other two localities, where only one callosity is present it is almost invariably on the right hand side (all but one in each case being found on that side).

Table 1

Incidence of head callosities in three Southern Hemisphere localities

No. of lip patches	Western Australia n = 293	South Africa* n = 223	Argentina* n = 188
None	58 (19.7%)	63 (28.3%)	38 (20.2%)
One - left only	1 (0.3)	1 (0.4)	1 (0.5)
- right only	5 (1.7)	17 (7.6)	11 (5.9)
Two	229 (78.2)	142 (63.7)	138 (73.4)

* Data from Best (in press).

Frequencies of occurrence of the three body markings (white dorsal blazes, grey dorsal blazes, partial albinism) in the three Southern Hemisphere areas are given in Table 2.

White dorsal blazes - relatively small, well-defined marks - have been recorded exclusively in 'non-calves' off Western Australia. Their incidence (in 4 out of 293, i.e. 1.4%) is significantly lower than off South Africa as recorded by Best (18 out of 224 individuals, 8.0%) (chi-square, Yates' corrected value for small numbers, =15.5, 1df, $p < 0.005$). It is, however, very similar to that for Argentina (9 out of 484 individuals, 1.9%, Payne *et al.*, 1983). Off the eastern United States such marks have been identified on calves and are regarded as birth marks (Kraus, pers. comm.).

Table 2.

Incidence of body markings in three Southern Hemisphere localities

		Western Australia	South Africa*	Argentina*
White dorsal blazes	Non-calves	4/293, 1.4%	18/224, 8.0%	9/484, 1.9%
	Calves	0/143, 0%	?	
Grey dorsal blazes	Non-calves	10/293, 3.4%	23/224, 10.3%	7/484, 1.4%
	Calves	1/143, 0.7%	?	
Partial albinos	Non-calves	5/293, 1.7%	? 3.6%	
	Calves	4/143, 2.8%	13/260, 5.0%	7/484, 1.4%
	Cows	1/113, 0.9%	3/209, 1.4%	

* Data from Best (in press).

Grey dorsal blazes - larger, more diffuse but still relatively well-defined marks - have been recorded off Western Australia, again almost exclusively in non-calves. Their incidence (10 out of 293 non-calves, 3.4%) is again significantly lower than off South Africa (23 out of 224 non-calves, 10.3%) (chi-square=9.98, 1df, $p < 0.005$). There is one Western Australian instance where a calf with very distinct large white markings was recognised one year later as a non-calf with a typical well-marked grey dorsal blaze (Match 18), confirming the darkening of colour in these marks with age. Another calf had a most unusual white colouration of the distal half of each tail fluke. Nothing comparable has been recorded in non-calves off Western Australia.

Partial albinism has been recorded both in calves and non-calves off Western Australia, and off South Africa. In calves off Western Australia there were 4 instances out of 143 individuals (2.8%) not significantly fewer than off South Africa (13 out of 260, 5.0%; chi-square, corrected, =0.58, 1df $p \approx 0.50$).

Similarly, in non-calves, the Western Australian and South African incidences were not significantly different (Western Australia, 5 out of 293, 1.7%; South Africa, 3 out of 209, 3.6%; chi-square=0.15, 1df, $p \approx 0.75$).

Off South Africa, Best found a distinctly lower partially albinistic proportion in adult cows than in calves (1.4% cf 3.6%, $p = 0.0345$). This is not the case in the data from Western Australia. Although the incidence in cows is very low (1 out of 113, 0.9%) it is not significantly different from the proportion in calves (2.8%, chi-square, corrected, =0.41, 1df, $p \geq 0.50$).

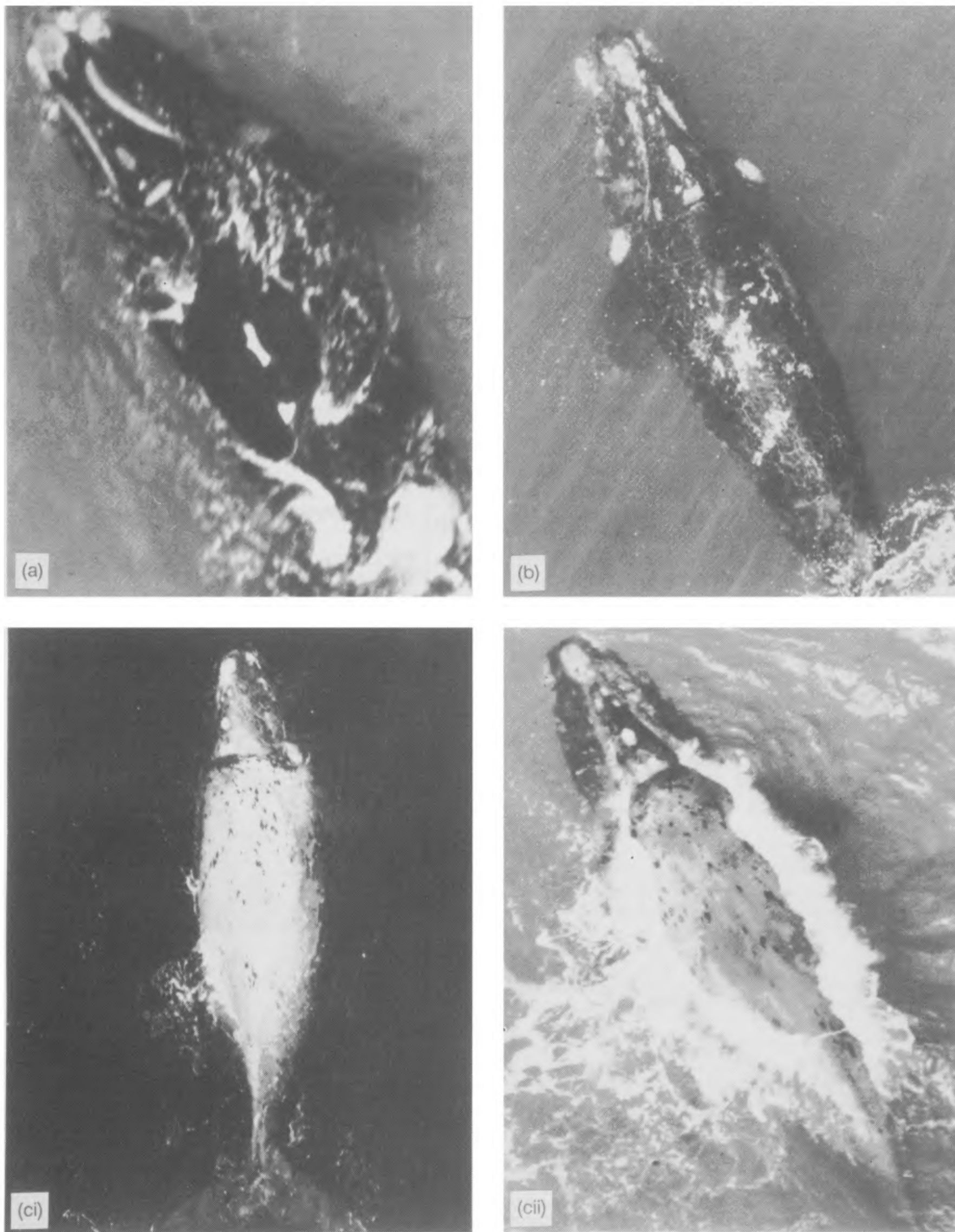

Fig. 5. Examples of body markings; Western Australia, 1978-87. (a) White dorsal blaze (Match 17, observed over 11 years). (b) Grey dorsal blaze (Match 53, 5 years). (c) Partial albinism (Match 75, 9 years): i 1978, probable yearling; ii - 1987, with own calf (out of photo).

In three characters (lip patches, white dorsal blazes, grey dorsal blazes), the Western Australian animals thus differ from those off South Africa while in two (white dorsal blazes, grey dorsal blazes) they are closer to those off Argentina. The differences may reflect different breeding populations, but whether this is the case depends on knowledge of each individual's heredity, which is not possible to obtain from the current field observations.

Some examples of different body markings from Western Australia are shown in Fig. 5.

Relationships within populations

Within the animals so far observed along the Western Australian coast, there are differences between different classes of animals in group size, time spent on the coast and dispersal, the latter both within and between years.

Population structure

Among those 'non-calves' recorded as 'other adults' (i.e. where no calf was seen accompanying the adult), while by far the majority were either single animals or pairs, as many as 15 have been recorded together (Table 3 (a)). Where calves were present, most sightings were of single cow-calf pairs, although up to five cows, each with a calf, have been seen together (Table 3 (b)). In addition, single cow and calf pairs have been seen associated with groups of up to five other adults, and on one occasion four cow and calf pairs were in association with a further 18 adults – the largest grouping (26 animals) yet recorded off this coast.

Distribution

It is clear that some parts of the coast are favoured more than others. Fig. 6 gives plots of the distribution, by 50 n.mile 'block', of all individual groups of animals seen. It shows at least four distinct areas where right whales can be expected: near Cape Leeuwin itself; in a wide region, spanning some 150 n.miles, from Cheynes Beach to Hopetoun (blocks 5–7); east of Esperance (block 9); and east of Israelite Bay (block 11).

Period between sightings (within years)

The longest period between sightings of one individual in any year is 89 days, or nearly 13 weeks. That animal (Match 27) was first seen as a single adult on 3 July 1983; 38 days

later, on 10 August, it was seen again, this time accompanied by a calf. It was seen twice more that year, on 17 September and 30 September, each time with a calf. Three other animals first seen as single adults had calved when next seen in the same year. Elapsed times between their being seen first as single animals and then with calves were 38, 20 and 17 days (Matches 60, 24 and 60 respectively). But because no animal giving birth has yet been seen more than once unaccompanied by a calf in the year in which it gave birth, there is no Western Australian evidence yet on the length of time a cow may spend on the coast before giving birth. The fact that no cow has been seen twice before calving may, however, mean they arrive shortly before giving birth.

Cows accompanied by calves have been recorded as staying on the coast considerably longer than adults without calves (11 weeks cf. 6 weeks, Table 4). Included in the table are the four animals referred to above which were first seen as single adults before calving, but only for the period during which they were accompanied by calves. There is a significant difference at the 5% level between the two sets of data (Mann-Whitney U Test).

Table 3.

Group size frequencies, Western Australia, 1977-87 (data from flights used in estimating abundance - see Table 8)

(a) Adults without calves*

Number of animals	1	2	3	4	5	6	7	8
Frequency (%)	24 (35.8)	25 (37.3)	7 (10.5)	1 (1.5)	4 (6.0)	0	1 (1.5)	1 (1.5)
Number of animals	9	10	11	12	13	14	15	Total
Frequency (%)	1 (1.5)	1 (1.5)	1 (1.5)	0	0	0	1 (1.5)	67 (100)

(b) Cows with calves

Number of pairs	1	2	3	4	5	Total
Frequency (%)	48 (77.4)	8 (12.9)	4 (6.5)	1 (1.6)	1 (1.6)	62 (100)

*i.e. only groups where no cows were present

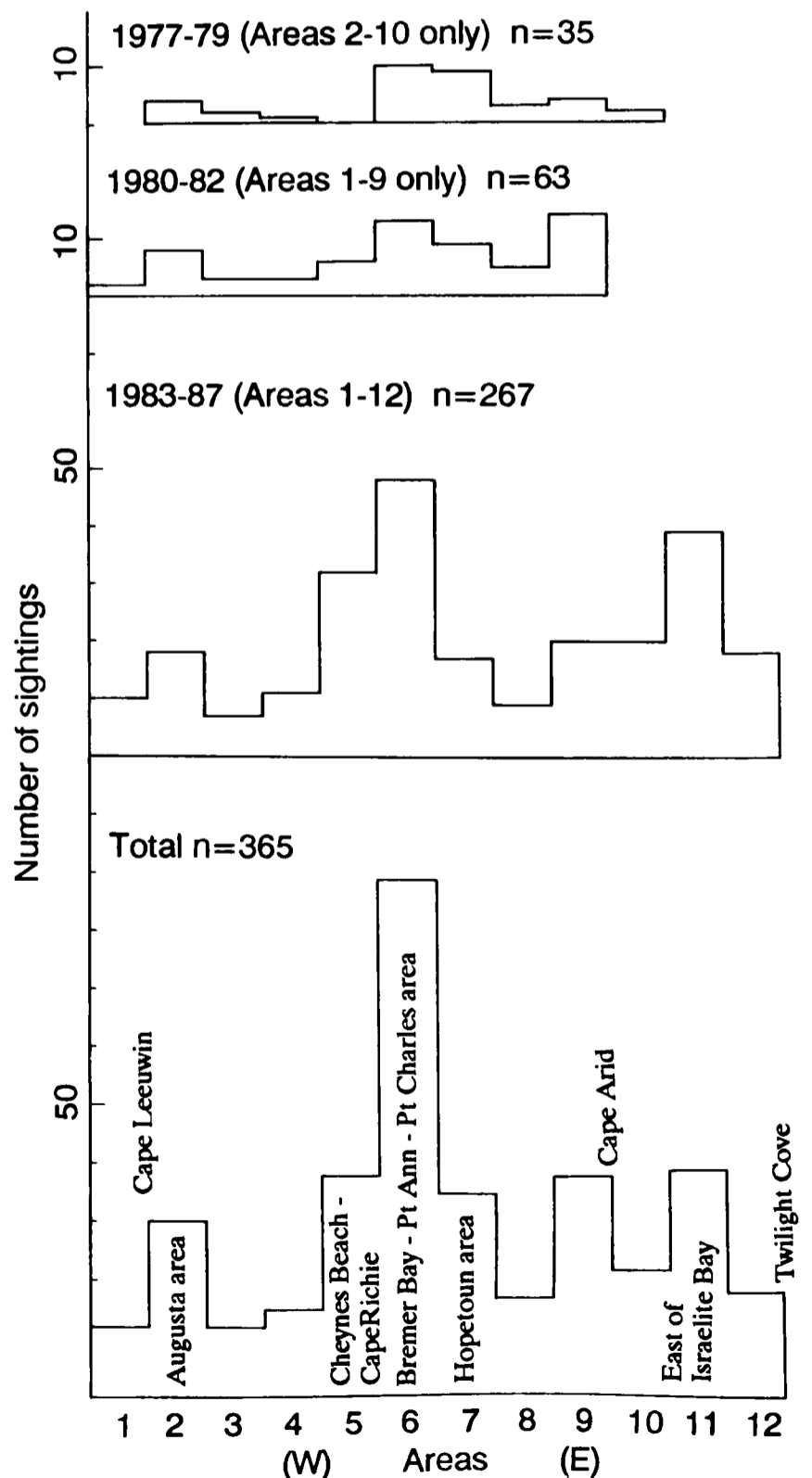

Fig. 6. Distribution by 'blocks', east of Cape Leeuwin-Twilight Cove, Western Australia; all animals.

Table 4.
Period between sightings (within years)

	Length of time recorded on coast in weeks											Total
	1	2	3	4	5	6	7	8	9	10	11	
Cow with calf	1	5	6	7	6	1	4	2	1	3	1	37
Adult (no calf)	1	5	2	3	7	2	0	0	0	0	0	20
Yearling	0	0	0	0	0	0	1	0	0	0	0	1
Total	2	10	8	10	13	3	5	2	1	3	1	58

Period between sightings (between years)

The range of repeat sightings off Western Australia now extends over 11 years (a female, Match 17, first seen in 1976 and again in 1981, 1984 and 1987, see Fig. 7). For cows accompanied by calves, the elapsed time between

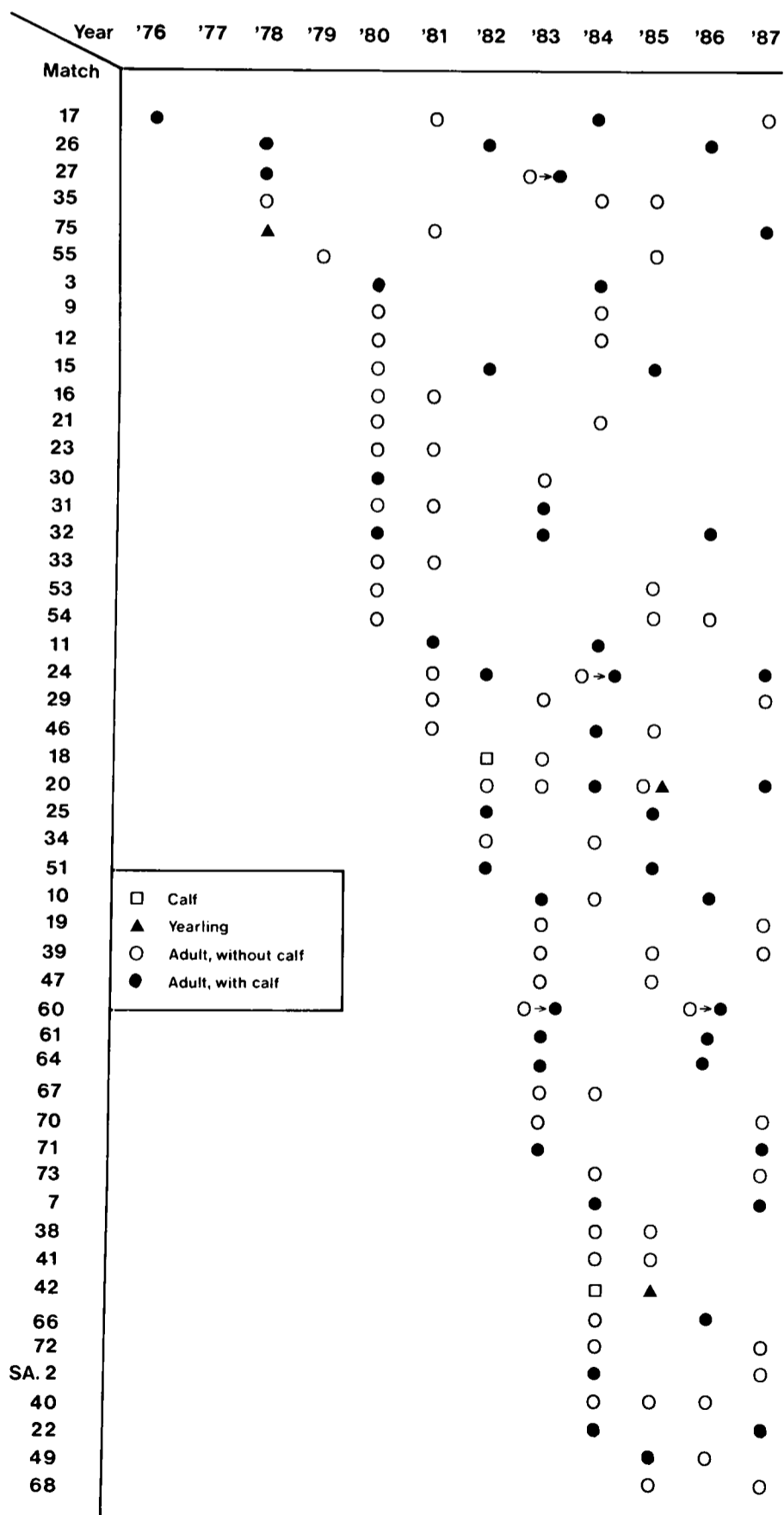

Fig. 7. 'Between Year' Matches, Western and South Australia, 1976-87.

Table 5.
Elapsed time between sightings

	No. of years elapsed						Total
	1	2	3	4	5	6	
<i>(a) Cows with calves</i>							
Frequency	6	7	16	4	2	1	36
(%)	(16.7)	(19.4)	(44.4)	(11.1)	(5.6)	(2.8)	(100)
<i>(b) Adults without calves</i>							
Frequency	11	6	3	6	2	2	30
(%)	(36.7)	(20.0)	(10.0)	(20.0)	(6.7)	(6.7)	(100)

sightings ranges from one to six years, with a well-defined peak at three years (Table 5).

For adults without calves, the range is also six years, but the pattern is rather different, with a well-defined peak (37%) of animals returning after one year and equal but lower percentages (20%) also prominent at two and four years.

Dispersal (between years)

Most animals (76%) recorded in a subsequent year or years were not more than about 150 n.miles from the place where first sighted, although some were found much further away (Table 6). Not included in the table are seven animals which show movement between Western Australia and South Australia during the period.

The shapes of the distributions for cows accompanied by calves and for other adults appear to be rather different (Table 6). Both are negatively skewed, but with the mode for cows with calves at block 0, and for 'other animals' at block 2, suggesting that cows with calves will tend to return to the same or an adjacent area more readily than other adults. But there is no significant difference between the two distributions (Mann-Whitney U Test), nor between the medians for either group ($p=0.250-0.100$).

There is some indication that the range over which the animals are distributed has increased. The situation is complicated because the length of coastline searched has itself changed, particularly since 1983. Nevertheless Fig. 6 shows that in the early years of the survey, 1977-80, only a small proportion (6%) of all sightings occurred in the most eastern part of the survey area (block 10). Unfortunately there was no searching there or even further east (in blocks 10, 11 or 12) in 1980-82, but from 1983 onwards relatively larger numbers (29%) were seen in those blocks. At the same time there was an increase in the numbers seen in the central part of the search area, particularly in the Bremer Bay-Point Ann-Point Charles region. This could indicate

Table 6.
Distance traversed between years

	Number of 50 n.mile blocks traversed							Total
	0	1	2	3	4	5	6	
Cows with calves	9	6	5	6	3	1	1	32
Adults without calves	3	2	8	5	4	1	3	26
Total	12	8	13	11	7	2	4	58

an expansion of range of a population increasing in size over the period, or juvenile dispersal, or both. It may be significant that the only two animals first identified individually as calves were each seen the following year 150 or more n.miles from where they were first recorded.

Dispersal (within years)

There is a marked difference in the pattern of dispersal between cows accompanied by calves and other adults (Table 7), allowing for a minimum of one month between sightings. Apart from one cow-calf pair which traversed some 300 n.miles between sightings in one year, cows accompanied by calves have tended to stay relatively close to the place where first seen, even though they spend a longer time on the coast than other adults. 68% of the 25 cow and calf sightings had not moved more than 50 n.miles, whereas all other adults had moved further than that, and their pattern of dispersal is much more evenly spread over the range (50 to 250 n.miles). There is a significant difference at the 5% level between the two distributions (Mann-Whitney U Test).

Table 7.

Dispersal within years

	Number of 50 n.mile blocks traversed								Total
	0	1	2	3	4	5	6	7	
Cows with calves	17	4	2	1	0	0	1	0	25
Adults without calves	0	4	2	1	3	1	0	0	11
Total	17	8	4	2	3	1	1	0	36

POPULATION PARAMETERS

Population status

A major aim of the aerial survey programme was to determine whether or not the population off Western Australia has shown any sign of increase over the period. Results from other sources, e.g. incidental sightings (Bannister, 1986a), could not answer that question unequivocally, although there was a strong presumption that such an increase was occurring. Information from aerial surveys suggested that there had been some increase up to 1982.

Analyses of the data available to 1987 indicate that an increase has indeed been occurring. Various attempts have been made over the years to arrive at an appropriate index of relative annual abundance. The greatest number seen on a single coverage of the 'standard area' (Cape Leeuwin - Cape Arid) in any one year has been used recently as the most appropriate index. This eliminates any error due to 'resightings' of animals between the flights.

It is now possible also to utilise some of the data obtained from between Cape Arid and Israelite Bay (block 10), where in recent years further animals have been seen. Because the area east of Israelite Bay (blocks 11 & 12) has only been searched regularly since 1985, the relatively large numbers seen in that area recently have not been included in the comparison.

Table 8
Southern right whales, Western Australia, 1977-87.
Indices of abundance

Area:	C. Leeuwin-C. Arid			C. Leeuwin-Israelite Bay		
	a	b	c	a	b	c
Group:						
1977	14	8	3	14	8	3
1978	23	11	6	23	11	6
1979	9	5	2	9	5	2
1980	29	23	3	-	-	-
1981	42	40	1	-	-	-
1982	20	6	7	-	-	-
1983	13	5	4	21	5	8
1984	43	25	9	44	26	9
1985	37	23	7	37	23	7
1986	32	10	11	32	10	11
1987	39	23	8	43	25	9

Two sets of data are therefore now available for comparison: Cape Leeuwin to Cape Arid (blocks 2-9); and Cape Leeuwin to Israelite Bay (blocks 2-10). Data are available for the former in an unbroken series from 1977. (In 1976, the first year of operation, the whole area was not covered in any single flight.) For the slightly larger area of the latter, data are available for 1977 to 1979, and from 1983 to 1987.

The results are tabulated in Table 8 for each of the two data sets by three main groups: 'all animals'; 'other animals'; and 'cow-calf pairs'. 'Other animals' are those other than cow-calf pairs.

Inspection of the series suggests a generalised increase over the period, but there are anomalous 'peaks' in 1981 and 1984, at least in 'all animals' and 'other animals'. The numbers in each of those years are particularly affected by sightings of one or more larger groups of animals than normally encountered. For example, in 1981, one group of 15 animals (with no calves) was seen in Dillon Bay (34°28'S, 119°19'E) and another of 10 off Taylor Island (33°55'S, 122°52'E). In 1984, a group of 26 animals (including four calves) was seen in Tagon Harbour (33°53'S, 122°59'E).

Fitting exponential curves to the data of Table 8 results in significant slopes (at the 5% level) in three of the six sets of data (Table 9). Those not significant are 'all animals' (for Cape Leeuwin to Cape Arid) and 'other animals' (for both areas). For cow-calf pairs the slopes for both areas are significant.

Table 9

Southern right whales, Western Australia, 1977-87.
Best fit curves to data of Table 8. Regressions for groups a and b in the C. Leeuwin-C. Arid area and group b in the C. Leeuwin-Israelite Bay area were not significant

Area:	C. Leeuwin-C. Arid		C. Leeuwin-Israelite Bay
	c	a	c
Group:			
Regression:	$y=0.0001e^{0.13x}$	$y=0.0016e^{0.117x}$	$y=0.00025e^{0.1227x}$
Significance:	0.01 < p < 0.05	0.01 < p < 0.05	0.01 < p < 0.05
Rate of increase: (%, ± 2SE)	13.0 ± 11.7	11.7 ± 7.2	12.3 ± 7.7
Range of increase (%)	1.3 - 24.7	4.5 - 18.9	4.6 - 20.0

The point estimates of increase range from 11.7% (all animals, Cape Leeuwin-Israelite Bay) to 13.0% (cow-calf pairs, Cape Leeuwin – Cape Arid), with cow-calf pairs (Cape Leeuwin – Israelite Bay) at 12.3%. These values appear rather high, particularly compared with the rate of increase (for cows and calves) recently obtained off South Africa of $6.8 \pm 2.0\%$ (Best and Underhill, 1990). However the 95% confidence limits for the Western Australian data are very wide (1.3–24.7% maximum), and encompass the South African results.

From the above it seems reasonable to conclude, as off South Africa, that at least for that part of the population that regularly visits the coast, i.e. cows with calves, there has been a significant increase in number off the Western Australian coast in the eleven year period since 1977.

No attempt has yet been made to estimate absolute abundance. The greatest number seen on one complete flight between Cape Leeuwin and Caiguna is 71, including 13 calves, in August 1987. The greatest number of individuals identified in any one year (1985) is 81, including 21 as calves in cow-calf pairs. Assuming there have been no matches missed, that figure must represent the minimum population size off the Western Australian coast at present.

Reproduction

Direct evidence of age at first reproduction is available only from one Western Australian animal so far. 'Match 75' was recorded in 1978, 1981 and 1987. In 1978, it was recorded as a 'juvenile' accompanying an adult. The determination was based mainly on the animal's relative size, more than 70% (in length) of the accompanying animal.

In 1981 the same animal was recorded as one of a pair of adults accompanied by a calf. The calf was not associated with this animal. In 1987 the same animal was recorded as a cow with a very small calf. There is no doubt of the animal's identity. In addition to its individual head callosity pattern the animal was a 'partial albino' – i.e. grey with darker specks. When first seen, in 1978, it was recorded as 'very white', which confirms its young age then. Evidence from South America (Payne *et al.*, 1983) suggests that partially albino calves lose their white colour within the year, so this animal is likely to have been no more than a yearling in 1978. Photographic measurements from South Africa indicate it was likely to have been a yearling rather than a calf. In 48 records from August to November 1988, calves ranged from 35.1 to 60.2 per cent of their mothers' length (Best, pers. comm.).

If the animal was a yearling in 1978, and itself had its first calf in 1987, its age would have been ten years at first parturition. This is the first indication of age at first parturition for this species in Australian waters.

The three year calving interval observed elsewhere is also the norm off Western Australia. In 67% of the 21 records of cows accompanied by calves in more than one year, the resighting time (between years) is three years (Table 10). The mean calving interval is 3.143 ± 0.84 years. This compares with Best's (1985) estimate of 3.39 ± 0.16 (2 SE) for South African animals. Of 24 cows recorded as returning to the Western Australian south coast since 1976, 7 were recorded as having calves once, 15 twice and 3 three times (Fig. 7).

Only two animals identified in one year as cows accompanied by calves were seen in the previous year (Matches 20 and 24). Neither was recorded as 'mating' in

the earlier year. Match 24, a cow with a calf in 1982, was recorded as a 'single adult' the year before. Match 20 was recorded as one of two or three adults in 1982, as a single adult in 1983, and as a cow with a calf in 1984.

Table 10.

Calving intervals

	Intervals between calves (years)								Total
	1	2	3	4	5	6	7	8	
Frequency	0	1	14	4	1	0	0	1	21
Percentage	0	4.8	66.7	19.0	4.8	0	0	4.8	100

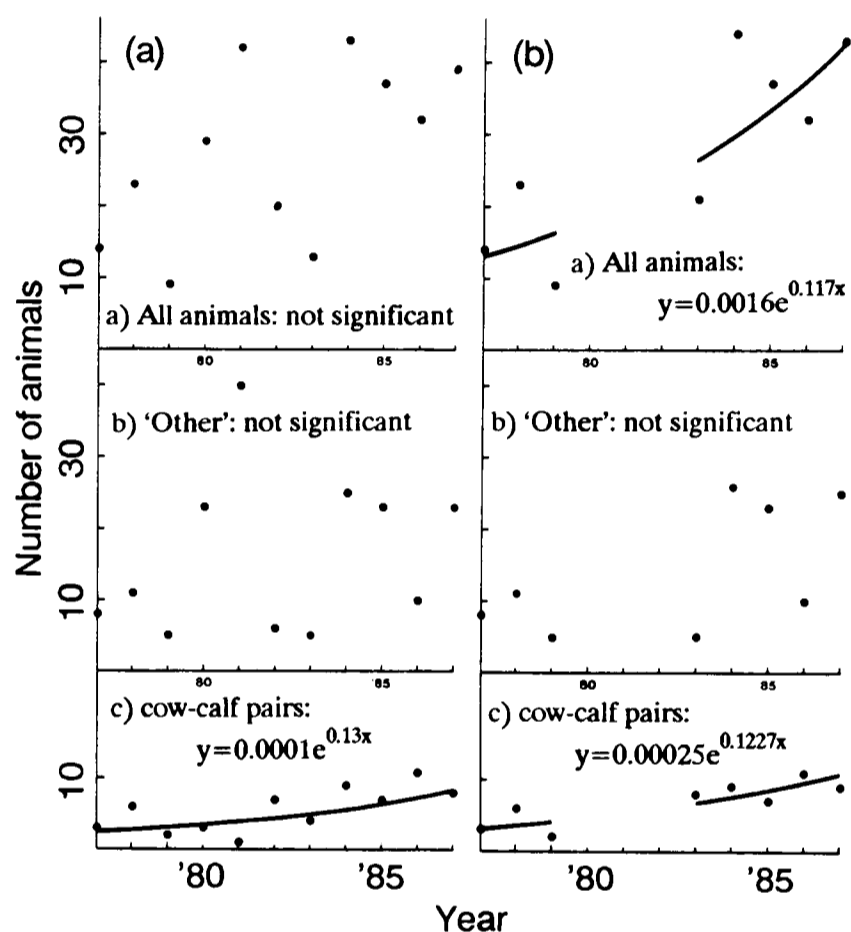

Fig. 8. Numbers seen from the aircraft, maximum in each year on one complete flight (a) Cape Leeuwin to Cape Arid (b) Cape Leeuwin to Israelite Bay. Data of Table 8; Best-fit curves of Table 9.

'Mating' was recorded in the aircraft logs on ten occasions between 1980 and 1987. In no case was an animal recorded as mating in one year seen either in the next, or in any later year, as a cow with calf. The small amount of evidence remains against the bulk of effective mating taking place on the coast. Indeed while some of the ten animals recorded in the flight logs as 'mating' have been definitely identified as males, there is no evidence yet from individually identified whales that any recorded as mating have actually been females.

ACKNOWLEDGEMENTS

J. Bell and R. Smith undertook almost all of the field observations on which the above is based; V. Milne provided administrative assistance. G.P. Kirkwood advised on regressions for Table 9, which were calculated by S. Wayte. P.B. Best provided information on cow/calf photographic measurements from South Africa. L.S. Brindle typed the manuscript. Since 1979 the field work has been funded by the Australian National Parks and Wildlife Service, Canberra.

REFERENCES

- Bannister, J.L. 1986a. Southern right whales: status off Australia from twentieth-century 'incidental' sightings and aerial survey. *Rep. int. Whal. Commn. (special issue 10)*:153-7.
- Bannister, J.L. 1986b. Notes on nineteenth century catches of southern right whales (*Eubalaena australis*) off the southern coast of Western Australia. *Rep. int. Whal. Commn. (special issue 10)*:255-9.
- Best, P.B. In press. Natural Markings and their use in to determining calving intervals in right whales off South Africa. *S. Afr. J. Zool.*
- Best, P.B. and Underhill, L.G. 1990. Estimating population size in southern right whales, *Eubalaena australis*, using naturally marked animals. Paper SC/A88/ID16 (published in this volume).
- Chittleborough, R.G. 1956. Southern right whale in Australian waters. *J. Mammal.* 37(3): 456-7.
- Kraus, S.D., Moore, K.E., Price, C.A., Crone, M.J., Watkins, W.A., Winn, H.E., and Prescott, J.H. 1986. The use of photographs to identify individual North Atlantic right whales (*Eubalaena glacialis*). *Rep. int. Whal Commn. (special issue 10)*:145-51.
- Payne, R., Brazier, O., Dorsey, E.M., Perkins, J.S., Rowntree, V.J., and Titus, A. 1983. External features in southern right whales (*Eubalaena australis*) and their use in identifying individuals. pp. 371-445 In: R. Payne (ed.) *Communication and Behavior of Whales*. AAAS Selected Symposia Series 76, Westview Press, Colorado, 643pp.
- Payne, R. and Rowntree, V.J. 1984. (eds). *Southern right whales. A Photographic Catalogue of Individual Whales seen in the Waters Surrounding Peninsula Valdes, Argentina*. World Wildlife Fund, US and Center for Long Term Research Inc., Lincoln, Mass. 24+pp.

Bowhead Whales Reidentified Through Aerial Photography Near Point Barrow, Alaska

David Rugh

*National Marine Mammal Laboratory, NMFS/NOAA Bldg 4,
7600 Sand Pt Way NE, Seattle, WA 98115, USA*

ABSTRACT

The US National Marine Mammal Laboratory has collected aerial photographs of bowhead whales, *Balaena mysticetus*, near Point Barrow, each spring from 1984–7. There were respectively 22, 631, 290 and 211 images of sufficient quality to identify individual whales. A total of 647 conclusive and 217 inconclusive resightings were recognised within these four survey years. These resightings indicated that bowheads passed Point Barrow on a median bearing of 68° True at a mean travel speed of 4.0km/hr. As the season progressed, an increasingly greater proportion of the whales had white on their tails, supporting the hypothesis that older animals (and those with calves) migrate later in the season than younger whales. Between 1985 and 1986, arrival dates of three reidentified whales were consistent within 5 days, but three other whales varied up to 20 days between years. The sample of 234 photographed whales from 1985 and 164 from 1986, resulted in 6 resightings. A Petersen estimate calculated from this sample gives a bowhead population size of 5,538 (with a 95% CI of 1,763–9,314). This estimate is considered provisional because only a portion of the migration was sampled, only whale images with unambiguous marks were included in the samples, the population is not closed and the number of resightings is small.

INTRODUCTION

Bowhead whales (*Balaena mysticetus*) migrate from the Bering Sea past Point Barrow, Alaska, to the Beaufort Sea each year, generally between mid-April and early June (Braham, Fraker and Krogman, 1980). Their narrow migration corridor and consistent timing make Point Barrow an ideal area in which to sample the population. In spring 1984, the US National Marine Mammal Laboratory (NMML) carried out an exploratory study by photographing these whales vertically from an aircraft near Point Barrow. This study followed similar photogrammetric efforts carried out from late July to September in the Beaufort Sea by LGL Ltd in 1981 (Davis, Koski, Richardson, Evans and Alliston, 1982) and 1982 (Davis, Koski and Miller, 1983) and by the NMML in conjunction with Cascadia Research Collective in 1983 (Cabbage, Calambokidis and Rugh, 1984). The NMML's photogrammetric study of bowhead whales near Point Barrow continued through 1987. Measurements of whales photographed during the springs of 1985–86 were reported by Nerini, Withrow and Strickland (1987). Results from reidentifications of individual whales are reported here. The study's objectives were to learn more about bowhead whale migration (travel orientation, speed and timing) and life history parameters (population size, calving intervals, etc.).

METHODS

Aerial photography was used to collect permanent records of dorsal views of bowhead whales for purposes of identifying individuals (Fig. 1). A twin-engine, high-wing aircraft was flown generally at 185km/hr (100 knots) and approximately 150m (500ft) altitude. Surveys were carried out during the spring whale migration in the Point Barrow area from 26 April–14 May 1984 (essentially a feasibility study), 21 April–7 June 1985, 2 May–1 June 1986 and 19 April–7 June 1987. Flights were usually less than 5hr long and within a 170km radius of Point Barrow. Tracklines

were nonsystematic searches along ice cracks but followed similar strategies throughout all three seasons. In order to maximise opportunities to photograph whales, the general approach was to fly where whales were expected to be found, such as along the shorefast ice edge, but the flights were kept east of Point Barrow to avoid whalers. When whales were located, several passes were made until the whale group was adequately photographed or until they dived out of sight.

Apart from in 1987, when the camera was fix-mounted over an open hole and fired remotely, photographs were taken with a handheld camera aimed vertically downward through a 48cm diameter hole covered with optical quality glass. A medium format (6x6cm) camera with a 150mm lens and an autodrive provided the best combination of large film size and fast film advance. A manual aperture was necessary to set the correct exposure for dark whales in dark water surrounded by bright ice. *Ektachrome* film (ASA 200) provided a reasonable compromise between minimizing motion blur and maximizing film resolution. An onboard HP-86B computer automatically recorded time and altitude along with positional data as provided by the aircraft's Global Navigation System (GNS).

Photographic transparencies were examined for whale images of sufficient quality (without excessive motion blur or exposure problems) and showing enough of each whale to be potentially reidentifiable. In some cases reidentifications could be made between neighboring transparencies, wherein only the best was selected for printing. These images were enlarged to 10cm and made into color prints cropped with one whale per print. Each image was set in a standardised position (with the head oriented to the left) to improve chances of reidentifying individuals. These procedures were established at workshops held in 1983 (Braham and Rugh, 1983).

Bowheads were categorised into one of 20 files according to the extent of white on their chins and caudal peduncles (Fig. 2). This facilitated inter-year matching attempts as only specific categories (including neighboring files) had to be compared. However, within each season all images

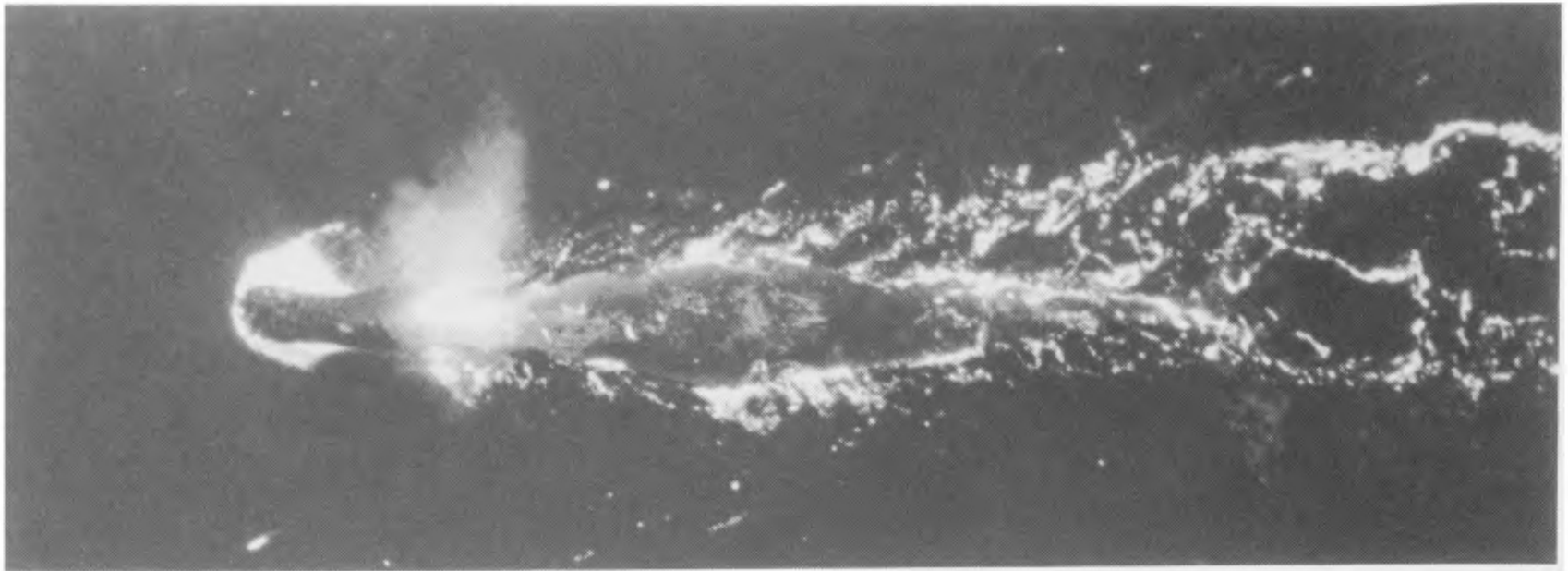

Fig. 1. This aerial photograph of a bowhead whale shows features used to identify individuals. The extent of white on the chin and the lack of white on the tail help categorize the whale (see Fig. 2), and white marks on the dorsal surface help identify the individual.

were compared against each other. There was a good distribution of whale images among the 20 categories, ranging from 1.2% to 8.2% per category.

The white areas on chins and caudal peduncles characterised bowheads to some extent but did not provide clear identification of individuals. Instead, acquired marks on the dorsal surface were used. Ephemeral marks, such as mud blotches or sloughing skin, allow for recognition of individuals seen minutes or hours apart. Deeper marks, such as cuts caused by ice or other surface trauma, provide identifications which presumably last many years. It was necessary to distinguish these permanent marks from water splashing across the whale.

When two similar images were found, large, unique marks or constellations of dots could be used in some cases to identify a match. Sometimes, however, only a few nebulous marks were visible. For these, matches were verified by measuring distances between marks relative to other whale features (e.g. fluke widths) visible in both photographs. A match was considered conclusive when several identical marks appeared on the same body locations in both images. A pair of images was considered conclusively to be of two different whales when the same area on both whales showed different marks. If two images were similar but there was a possibility they were from two different whales, the images were considered an inconclusive match. Only conclusive matches were used in subsequent analysis.

The date a whale migrated past Point Barrow was calculated relative to a common longitude ($156^{\circ}27'W$, the north-south line passing through the northernmost point of land). The time each whale crossed this was estimated by using the distance between it and the location of each whale and by assuming a 4.0km/hr travel speed (calculated here from resighting data). This enabled inter-year differences in migratory dates to be more accurately approximated.

Mark-recapture analysis to estimate population size could only be applied to the 1985 and 1986 photographs. Rates of bowhead whale sightings and calls (Fig. 3 from George and Carroll, 1987a) indicated that the timing of the 1985 and 1986 migrations were similar. The 1984 sample was too small for the analysis while the 1987 sample missed the portion of the season sampled in 1986. Two calculations were carried out. In one the sample was

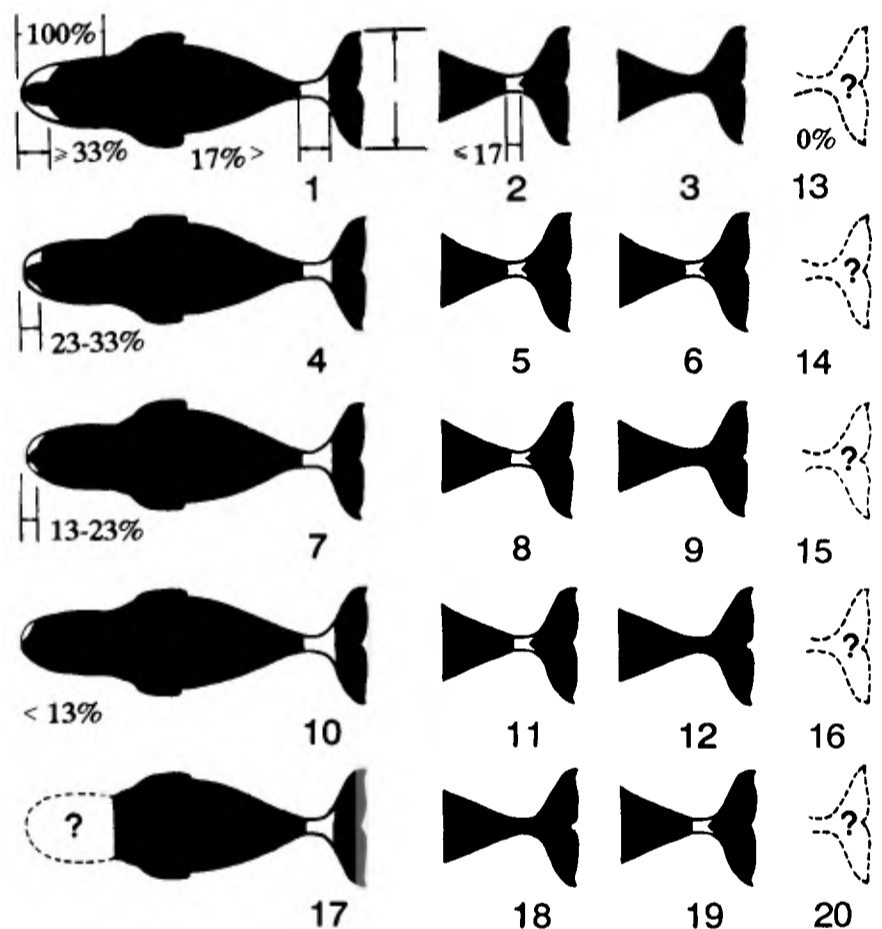

Fig. 2. There were 20 photographic categories (established by Davis *et al.*, 1983) used to sort bowhead whale images based on the extent of white on their chins and tails. Each row contains whales of similar chin characteristics; each column contains similar tail colorations. The rightmost column includes images where tail features were invisible; the lowest row includes images where chin features were invisible. Therefore, File 20 has neither tail nor chin features visible. Percentages show the amount of white on the chin relative to the rostrum length (rostral tip to blow hole), or the amount of white on the tail relative to fluke width.

restricted to the 2 May – 1 June period (the only portion of the migration photographed in both years) and in the other all the available data from 1985 and 1986 were used.

Only whale images showing both the rostrum and the broadest portion of the back were included in these calculations and sampling was restricted to clearly marked whales. This prevented an unknown number of whales from appearing in the second sample as unrecognised resightings. The assumption is that marked whales are

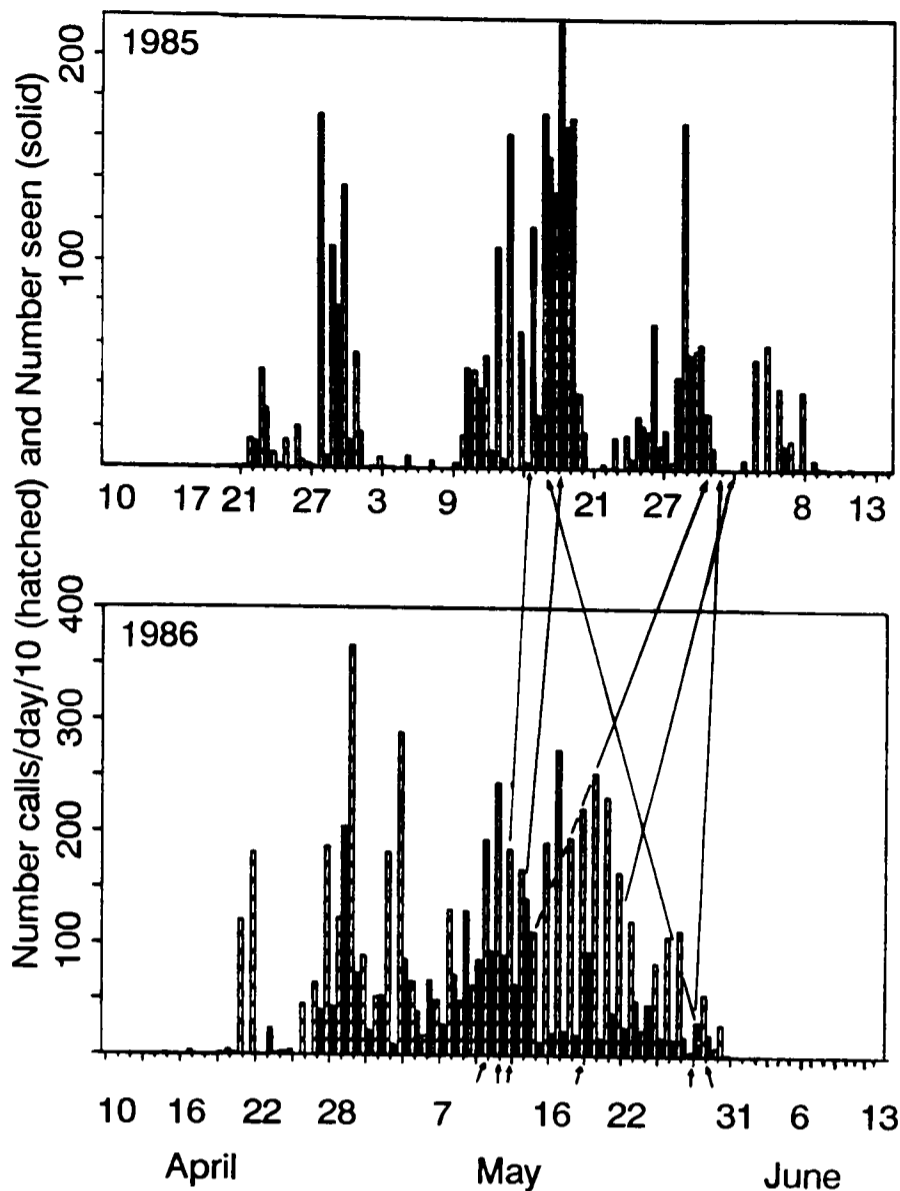

Fig. 3. Seasonal distribution of bowhead whale sightings and recorded calls near Point Barrow, Alaska, during censuses in 1985 and 1986 (from George and Carroll, 1987a). Whales photographed both years are indicated by the lines connecting the dates on which they passed near the census station.

representative of the total population such that the rate of reoccurrence of individuals between samplings would be the same whether or not they were marked.

Using S_1 as the sample from 1985, S_2 as the sample from 1986 and M as the number of matches between these years, a population size (N) was calculated *via* Chapman's (1951) modified Petersen estimate as recommended by Hammond (1986):

$$N = (S_1 + 1)(S_2 + 1) / (M + 1) - 1.$$

A variance was calculated as:

$$v(N) = (S_1 + 1)(S_2 + 1)(S_1 - M)(S_2 - M) / (M + 1)^2(M + 2).$$

RESULTS AND DISCUSSION

Sample size

Table 1 shows dates, total number of bowhead whale images photographed, number of prints entered into the NMML collection, number of identifiable whales (with conclusive duplicates removed) for intrayear and interyear comparisons (the latter excluding ephemeral marks), and number of intrayear reidentifications made (with the range showing conclusive and total matches). The feasibility study in 1984 was short (19 days), resulting in relatively few photographs. The only full season sampling was made in 1985. The start of 1986 was delayed by budgetary problems

while in 1987 a faulty aircraft altimeter and persistent, heavy fog reduced the sample in the latter portion of the season.

Of the 488 whales in photographic prints from 1984-7, 229 (47%) were reidentified at least once within the respective season, each on separate passes over the whales. Most of these reidentifications (71%) occurred within six minutes of the initial photograph (Fig. 4). Fourteen matches were each seen from 1-5 days apart.

Table 1

Sample size of photographs collected for identifying individual bowhead whales migrating past Point Barrow in the spring. The range in intrayear matches indicates conclusive versus total matches.

Dates	Total whale images	Printed images	Identifiable whales		Intrayear matches
			Intrayear	Interyear	
84/4/26-5/14	88	22	21	6	1 - 8
85/4/21-6/07	1,776	631	441	234	395 - 473
86/5/02-6/01	862	290	242	164	209 - 303
87/4/19-6/07	351	211	309	113	42 - 79
Total	3,077	1,154	1,013	517	647 - 863

Whale travel direction

The median direction for 81 pairs of bowhead whale sightings was 68° True (Fig. 5). Many of the bearings did not occur along the expected ENE migratory direction either because the whales were milling or the GNS locations were inaccurate. Multiple passes (45 in 1987) flown over fixed targets resulted in GNS location errors up to 1.89km with 90% of the error range within 0.58km. No pattern in the orientation of these errors was evident. By selecting the 14 resightings that occurred over 10hr apart, GNS location errors could be minimised. This also resulted in a median of 68° with 95% of the directions distributed between 49° and 105°. Observations from the ice-based census stations provided a similar median of 65° with 95% of the directions between 32° and 87° (George and Carroll, 1987b).

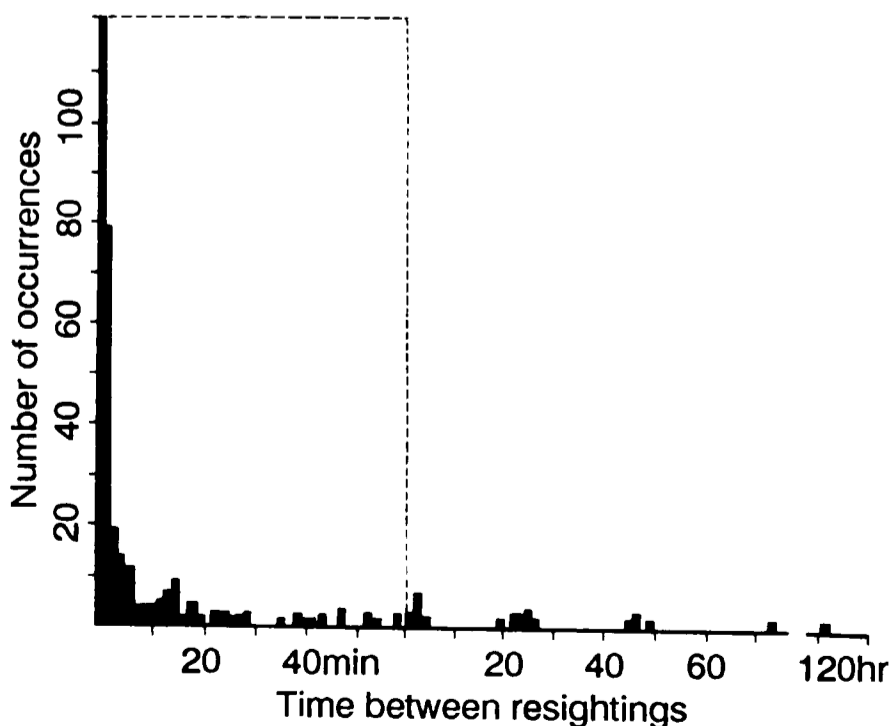

Fig. 4. Frequency of resightings of bowhead whales occurring within each of the 1984-7 survey seasons. Resightings made within an hour of the initial sighting are depicted in the expanded block for the first hour interval; all other resightings are shown by hour intervals.

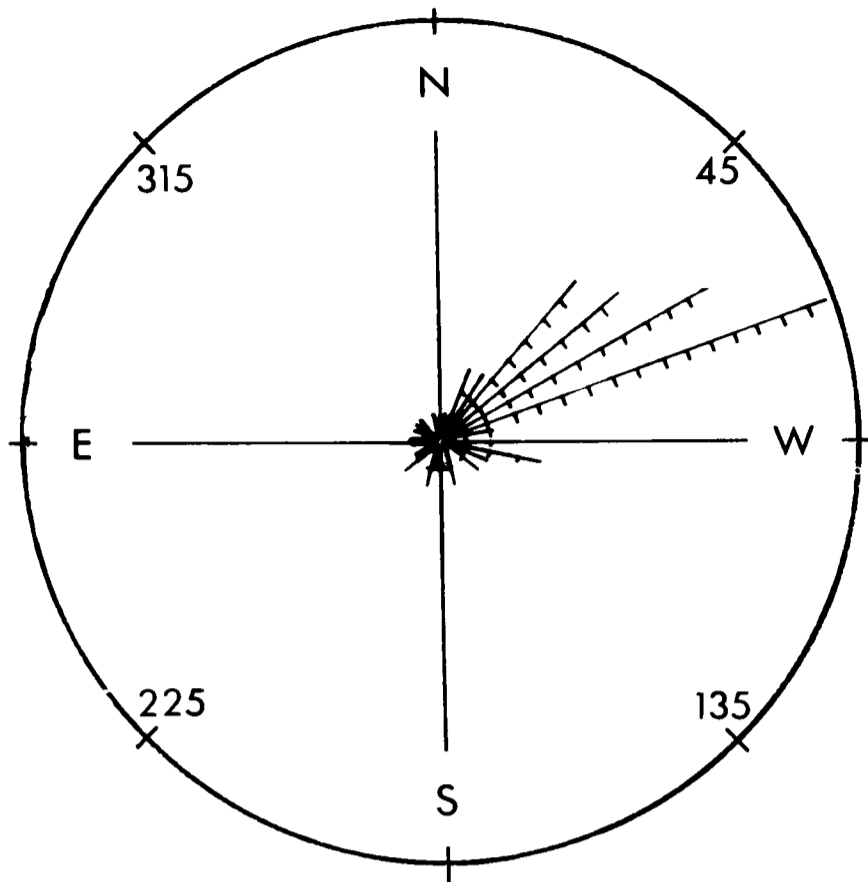

Fig. 5. Frequency distribution of travel directions of bowhead whales near Point Barrow, Alaska, 1984–7 as determined from paired intrayear resightings of individual whales. The 81 travel bearings (deg True) represented here were for sightings occurring more than 6 min apart. Each length unit on the radii represents one sighting made within the respective 10° increment.

Whale travel speed

Calculations of whale travel speeds were also hindered by GNS inaccuracies. For 55 resightings made 0.1–1.0hr apart, the mean speed (weighted by the duration of the time between resightings) was 5.4km/hr (SD=2.5); for 14 resightings made 1–10hr apart, the speed was 2.6km/hr (SD=2.3); for 14 resightings made >10hr apart, the speed was 1.2km/hr (SD=1.0, range 0.2–3.4km/hr). Whales that swam slowly or deviated from a migratory course were more likely to be photographed several times than were whales which moved quickly through the survey area (Fig. 6). This caused a downward bias in the apparent travel rates of whales observed for many hours. To minimise this bias and problems with GNS inaccuracy, the 30 resightings that occurred 0.1–10hr apart with orientations in the expected migratory direction (49°–105°) were selected as a sample of migrating whales. This resulted in a calculated mean travel speed of 4.0km/hr (SD=2.1). George and Carroll (1987b) calculated a comparable mean speed of 4.7km/h (SD=1.6) for 27 bowheads accompanied by calves observed from ice-based sites.

Pigmentation trends

The seasonal trend in extent of white pigmentation (Table 2) was examined through the 1985 and 1986 bowhead migrations, years with relatively thorough photographic coverage and similar migrational timing (Fig. 3). The seasons were divided into four periods based on whale sighting rates reported from the census stations. There was no apparent trend in the amount of white on chins ($P=0.49$; chi-square=8.41; 9 df), but there was clearly an increase in the relative degree of white on peduncles through the migration ($P<0.001$; chi-square=32.93; 6 df). Davis *et al.* (1983) demonstrated that larger (presumably older) bowheads have more white on their peduncles than

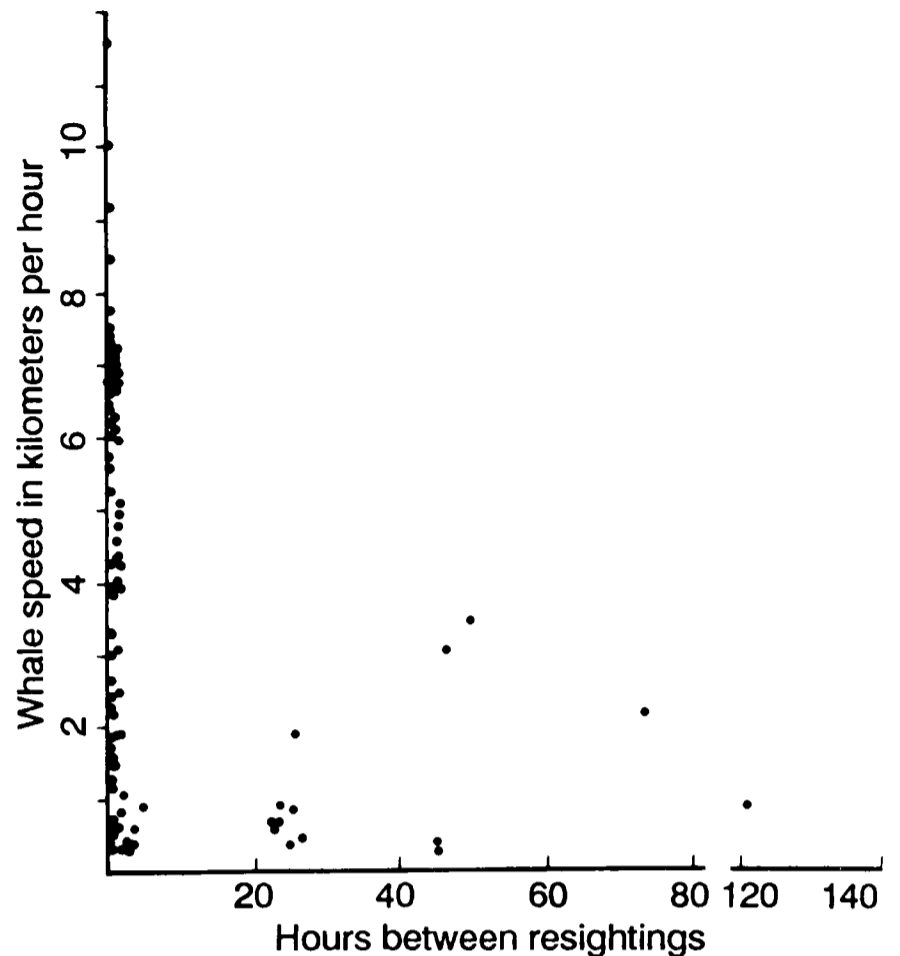

Fig. 6. Frequency of occurrence of calculated swimming speeds of bowhead whales near Point Barrow, Alaska, 1984–7 as determined from resightings of photographed individuals.

do smaller bowheads. Thus these observations concur with those of Nerini *et al.* (1987) who showed a trend of increasing bowhead size through the spring migration. Small animals tend to be seen earlier than large animals (exclusive of calves which are seen late in the season accompanied by large adults).

Recognisability as a function of whiteness

There was no apparent correlation between the rate of recognised matches and the extent of white on the chin (Table 3; $P=0.50$, Theil Test). Because whales of all lengths, including neonates, have variable amounts of white on the chin, the age, and therefore amount of scarring and recognisability, would not be expected to correlate with extent of chin whiteness. However, matches were twice as likely to occur among whales with white on their caudal peduncles (categories 1 and 2) as among dark whales (category 3; Table 3). This also corresponds with

Table 2

Seasonal trends in pigment marks on bowhead whales passing Point Barrow, Alaska, during the spring as detected in aerial photographs. The relative amount of white on the chin and tail is ordered from most to least, the latter being apparently all-dark whales.

Dates	Chin markings				Tail markings		
	1	2	3	4	1	2	3
4/27 - 5/5	5 23%	9 41%	5 23%	3 14%	0 0%	8 50%	8 50%
5/06 - 5/21	39 17%	87 38%	73 32%	30 13%	48 26%	59 32%	80 43%
5/22 - 6/1	25 18%	45 32%	48 34%	23 16%	49 38%	51 39%	30 23%
6/02 - 6/7	7 28%	4 16%	8 32%	6 24%	14 56%	10 40%	1 4%

Table 3

Bowhead whale photographic images categorized by the extent of white on chins and tails and correlated to the number of matches recognized between images. This includes all photographic prints categorized by whale coloration (1,172) from the NMML's 1984-87 collection. The relative amount of white is ordered from most to least.

Extent of white	Number of whales (%)	Number of matches (%)	Percentage matched
Chins: 1	193 (16)	110 (18)	57
2	318 (27)	180 (29)	57
3	305 (26)	137 (22)	45
4	164 (14)	108 (18)	66
Unknown	192 (16)	82 (13)	43
Tails: 1	237 (20)	147 (24)	62
2	294 (25)	204 (33)	69
3	355 (30)	122 (20)	34
Unknown	286 (24)	144 (23)	50

the view that the amount of white on a bowhead whale's peduncle increases with age as does the amount of scarring and, therefore, recognisability. Young animals have fewer scars and might appear in the photographic collection several times as unrecognised or as inconclusive matches. Davis, Koski and Miller (1986) demonstrated a relationship between increased bowhead length (i.e. age) and increased scarring.

Interyear matches

Comparing photographs from 1984 with the succeeding years resulted in only one inconclusive match. Between 1985 and 1986 there were 6 conclusive and 5 inconclusive matches. Fig. 3 depicts the temporal linkages of whales seen between these two years. Three whales were seen on almost the same date each year (with differences of 3.5, 4.0 and 5.2 days), and three whales were seen weeks apart (with differences of 12.1, 14.6 and 20.4 days). All but the 12.1 day difference were matches occurring earlier in 1986 than in 1985. These six pairs of links all occurred on the expected migratory route for whales passing within 2km of the shorefast ice edge near Point Barrow. Some marks were retained very well between years. This was also observed for resightings in the Beaufort Sea occurring up to five years apart (Gary Miller, pers. comm.).

Calves

Among the 21 identifiable whales photographed in spring 1984, there were no calves. Calves were associated with 8 (2%) of the 441 identifiable whales in 1985, 23 (10%) of the 242 in 1986 and 3 (1%) of the 309 in 1987. Nerini *et al.* (1987) found 1.1% and 12.8% calves among photogrammetrically measured bowheads in 1985 and 1986 respectively. Ice-based observers counting bowheads during the spring migration past Point Barrow recorded 2% calves in 1984 (Dronenburg, George, Krogman, Sonntag and Zeh, 1986), 1% in 1985 (Krogman, George, Carroll, Zeh and Sonntag, 1986) and 3% in 1986 (George, Carroll, Tarpley, Albert and Yackley, 1987).

Among photographed whales, only one adult associated with a calf in one year was reidentified in another year. This whale passed Point Barrow late in the migration both years, 1 June in 1985 and 28 May in 1986. It will take many more years of sampling and increased sampling per year before we can establish patterns in reproductive rates. It is especially difficult to study reproductive rates during the spring migration because some calves are not born until

after the whales have passed Point Barrow while weaning might have occurred before the whales pass this area the following spring (Nerini, Braham, Marquette and Rugh, 1984).

Population size

In the mark-recapture analysis, 205 whales from 2 May to 1 June 1985 were compared with 164 from 1986 (the other years were inadequately sampled); six conclusive matches were found. If we allow the 205 to represent our first sampling (S_1) and 164 the second sampling (S_2) of the population (N) with the 6 matches as recaptures (M), then the population estimate is 4,855 ($SD=1.651$; 95% $CI=1,600-8,100$) which compares favorably with the 4,417 (95% $CI=2,613-6,221$) calculated from sighting data from ice-based censuses near Point Barrow as reported in IWC (1986). However, if the full season sampling from both 1985 ($S_1=234$) and 1986 ($S_2=164$) is used, the population size is estimated to be 5,538 ($SD=1.888$; 95% $CI=1,763-9,314$) which is within the standard error range of the bowhead population size (7,200; $SE=2,400$) reported by Zeh, Reilly and Sonntag (1988) when sighting and acoustic data from near Point Barrow were combined in a capture-recapture type analysis.

There are several important considerations to be made before we can accept mark-recapture techniques from photographically reidentified whales as a valid estimate of bowhead abundance.

- (1) Only a portion of the whale migration was sampled in 1986. As the temporal distribution of whales' migration timing was evidently non-random, either of the above calculations underestimate the total population size in that they do not represent whales coming after the sample period.
- (2) Some whales with faint identifying marks might not have been recognised although they were rephotographed; however, the process used for selecting the sample would have minimised this bias. Note that most biases in the process of seeking matches lead to not finding matches that are present rather than making matches that are not real. Verification of recognised interyear matches was made by several other biologists familiar with aerial images of bowhead whales (including Gary Miller and William Koski of LGL and James Cabbage of Cascadia Research Collective).
- (3) Images that appeared to be similar but were not conclusively of the same whale were not considered marked and were removed from the sample. This could result in downward bias for resightings (M) and hence an overestimation of the population size; however, on the assumption that marked whales and unmarked whales reappeared in the second sample at equal rates, the bias of removing unmarked whales should not be strong.
- (4) New marks may have been acquired between years, and some marked whales may have died or been absent in the second year. These biases tend to cause an overestimation of the population.
- (5) The sample size is small, particularly the number of recaptures (M), resulting in a large confidence interval and possible bias (Seber, 1982). Future photographic studies comparable to those described here could provide independent samplings for population size calculations and could eventually minimise some of these biases.

ACKNOWLEDGEMENTS

Mary Nerini and Howard Braham provided administrative support for this study. Judith Zeh and Jeffrey Breiwick gave statistical consultation. David Withrow, Kathy Strickland, Joanne Flanders and Barbara Taylor assisted with data collection and handling. Melanie Whitaker and Laurel Code assisted in the search for matches. Anne Sinclair and Celeste Whalen facilitated data processing. Helpful reviews were provided by Thomas Albert and John George of the Department Wildlife Management (North Slope Borough, Box 69, Barrow, AK 99723), Jeffrey Breiwick, Howard Braham, Camille Goebel-Diaz, Merrill Gosh, Mary Nerini, Dale Rice, Jack Turnock and David Withrow (National Marine Mammal Laboratory), Lori Quakenbush (College of Natural Sciences, University of Alaska, Fairbanks, AK 99775), Judith Zeh of the Department of Statistics (GN-22, Univ. of Washington, Seattle, WA 98195), Rolph Davis, Gary Miller and William Koski of LGL, Ltd. (22 Fisher St., PO Box 280, King City, Ontario, Canada, L0G LK0) and an anonymous reviewer.

REFERENCES

- Braham, H., Fraker, M. and Krogman, B. 1980. Spring migration of the Western Arctic population of bowhead whales. *Mar. Fish. Rev.* 42 (9-10):36-46.
- Braham, H. and Rugh, D. 1983. A photographic identification system for bowhead whales. US Dep. Commer., Natl. Oceanic Atmos. Admin., Natl. Mar. Fish. Serv., Northwest and Alaska Fish. Center, Wash., Proc. Rep., (unpublished) 43pp.
- Chapman, D. 1951. Some properties of the hypergeometric distribution with applications to zoological censuses. *Univ. Calif. Public. Stat.* 1:131-60.
- Cubbage, J., Calambokidis, J. and Rugh, D. 1984. Bowhead whale length measured through stereophotogrammetry. Final rept. to Natl. Mar. Mammal Lab., NMFS, NOAA, Seattle, Wash., Contract 83-ABC-00129. (Unpublished) 70pp.
- Davis, R., Koski, W. and Miller, G. 1983. Preliminary assessment of the length-frequency distribution and gross annual reproductive rate of the Western Arctic bowhead whale as determined with low-level aerial photography, with comments on life history. Rep. by LGL Ltd., Toronto, Ontario, for the Natl. Mar. Mammal Lab., NMFS, NOAA. Seattle, Wash. (Unpublished) 89pp.
- Davis, R., Koski, W., Richardson, W., Evans, C. and Alliston, W. 1982. Distribution, numbers and productivity of the Western Arctic stock of bowhead whales in the Eastern Beaufort Sea and Amundsen Gulf, summer 1981. Rep. by LGL Ltd., Toronto, Ontario, for Dome Petroleum Ltd., Calgary, Alberta, and for Sohio Alaska Petroleum Co., Anchorage, Alaska. (Unpublished) 134pp.
- Davis, R., Koski, W. and Miller, G. 1986. Experimental use of aerial photogrammetry to assess the long term responses of bowhead whales to offshore industrial activities in the Canadian Beaufort Sea, 1984. Rep. by LGL Ltd., King City, Ontario, for Northern Affairs Ottawa. 157pp.
- Dronenburg, R., George, J., Krogman, B., Sonntag, R. and Zeh, J. 1986. Report of the 1984 spring bowhead whale (*Balaena mysticetus*) ice-based visual census. *Rep. int. Whal. Commn* 36:293-8.
- George, J. and Carroll, G. 1987a. Overview of the 1985 and 1986 visual and acoustic census of bowhead whales off Point Barrow, Alaska with observations on the subsistence harvest. Abstract in the Fourth Conf. on the Biol. of the Bowhead Whale, *Balaena mysticetus*, March 1987, Anchorage, Alaska. 6pp.
- George, J. and Carroll, G. 1987b. Observations of spring migrating cow-calf pairs near Point Barrow, Alaska. Abstract in the Fourth Conf. on the Biol. of the Bowhead Whale, *Balaena mysticetus*, March 1987, Anchorage, Alaska. 6pp.
- George, J., Carroll, G., Tarpley, R., Albert, T. and Yackley, R. 1987. Report of field activities pertaining to the spring 1986 census of bowhead whales, *Balaena mysticetus*, off Point Barrow, Alaska with observations on the subsistence hunt. *Rep. int. Whal. Commn* 37:301-8.
- Hammond, P. 1986. Estimating the size of naturally marked whale populations using capture-recapture techniques. *Rep. int. Whal. Commn* (special issue 8):253-82.
- International Whaling Commission. 1986. Report of the sub-committee on protected species and aboriginal subsistence whaling. Annex H. *Rep. int. Whal. Commn* 36:95-109.
- Krogman, B., George, J., Carroll, G., Zeh, J. and Sonntag, R. 1986. Preliminary results of the 1985 spring ice-based census of the bowhead whale (*Balaena mysticetus*) conducted near Point Barrow, Alaska. *Rep. int. Whal. Commn* 36:343-52.
- Nerini, M., Braham, H., Marquette, W. and Rugh, D. 1984. Life history of the bowhead whale, *Balaena mysticetus* (Mammalia: Cetacea). *J. Zool., Lond.* 204:443-68.
- Nerini, M., Withrow, D. and Strickland, K. 1987. Length structure of the bowhead whale population derived from aerial photogrammetry, spring 1985 and 1986. Paper SC/39/PS14 presented to the IWC Scientific Committee, June 1987 (unpublished).
- Seber, G. 1982. *The Estimation of Animal Abundance and Related Parameters*. 2nd ed. MacMillan Pub. Co., N.Y. 654pp.
- Zeh, J., Reilly, S. and Sonntag, R. 1988. Appendix 3. Bowhead population estimate and variance. *Rep. int. Whal. Commn* 38:115-16.

Population Size, Migrations and Feeding Aggregations of the Humpback Whale (*Megaptera novaeangliae*) in the Western North Atlantic Ocean

Steven K. Katona and Judith A. Beard

College of the Atlantic, Bar Harbor, Maine 04609, USA

ABSTRACT

Through collaboration by nearly all cetologists and many amateurs photographing whales in the North Atlantic Ocean, over 9,000 photographs of humpback whale (*Megaptera novaeangliae*) flukes have been collected. As of 31 December 1986, 3,647 individual whales were represented in the collection. Over 1,100 photographically-verified resightings of individually-known humpbacks demonstrated the existence of at least four, and probably five, separate feeding aggregations, namely Iceland-Denmark Strait; western Greenland; Newfoundland (including the Labrador coast); Gulf of St. Lawrence; and Gulf of Maine-Scotian Shelf. Individual whales returned annually to a particular feeding region, but whales from all feeding aggregations migrated to nearshore areas and banks in the Dominican Republic, Puerto Rico and the Virgin Islands for breeding. Some whales from all feeding aggregations migrated north past the Bermuda Islands in Spring. The variance-weighted mean of annual capture-recapture estimates of the total North Atlantic humpback population for years 1979–1986 was $5,505 \pm 2,617$ (95% CI).

INTRODUCTION

Cetologists throughout the world use photographs of the distinctive pattern on the underside of the fluke for the identification of individual humpback whales (Kraus and Katona, 1977; Perkins and Whitehead, 1977; Katona, Baxter, Brazier, Kraus, Perkins and Whitehead, 1979; Katona and Kraus, 1979; Katona, Harcourt, Perkins and Kraus, 1980; Whitehead, Harcourt, Ingham and Clark, 1980; Katona and Whitehead, 1981; Perkins, Bryant, Nichols and Patten, 1982; Whitehead, Chu, Harcourt and Alling, 1982; Whitehead, Silver and Harcourt, 1982; Darling, Gibson and Silber, 1983; Tyack and Whitehead, 1983; Martin, Katona, Mattila, Hembree and Waters, 1984; Perkins, Balcomb, Nichols and Deavilla, 1984; Weinrich, 1984; Baker, Herman, Wolman, Winn, Hall, Kaufman, Reinke and Ostman, 1986; Darling and Morowitz, 1986; Clapham and Mayo, 1987; Kaufman, Smultea and Forestell, 1987; Stone, Katona and Tucker, 1987).

This paper describes efforts to compare all available fluke photographs from the North Atlantic region in order to: (1) document long-term, long-range movement patterns of individual whales; (2) identify population sub-units and examine movements between them; and (3) estimate the number of whales in the entire western North Atlantic Ocean and its component regions using capture-recapture techniques.

METHODS

Over 200 individuals or groups contributed photographs to the collection on which this report is based. Photographs dated from 1952 to 1987.

Standard black and white images, 5cm by 9cm, were printed from negatives or copied from 35mm colour slides using *Panatomic X* film (ASA 32), a *Nikon 55mm* macro lens and a *Bowens Illumatron* slide duplicator. Each unique individually-identified whale received a catalog

number and was represented by one standard photograph in the master catalog, located at the College of the Atlantic. Catalog photographs were stored in clear plastic pages, eight photos to a page. In the few cases where the right and left portions of a fluke were visible only in separate photographs, or where an individual was known only from two relatively poor photographs, both were included in the master catalog. Additional images of the identified whales were stored in sequentially-numbered envelopes. Data for all photographs in the collection were included in a computer file.

New batches of fluke photographs, organized into a pattern gradient from white to black, were compared manually with the existing collection by research assistants selected for patience and skill in pattern recognition (Katona and Kraus, 1979). Photographic comparisons were usually carried out singly to maximize concentration and accuracy, but several flukes with similar pattern elements were sometimes processed together.

Whenever a new photograph appeared to be of a previously cataloged whale, the match was confirmed by one of us and appropriate data were added to the computer file. If a photograph did not match any previously photographed animal, it received a new catalog number and was then entered in the master database, inserted in the master catalog and included in all future comparisons of new photographs.

The following data are maintained for each photograph: contributor name, roll and frame number, date, time, location, latitude, longitude, sex (if known from photograph of genitals or presence of calf), age class (calf or yearling, if known), group size (if whale was sighted with companions), companion identifications (if known) and whale name (if known). Whales were grouped by the region where they were photographed on the feeding range.

The master database was stored on the 30 MB hard disk of an upgraded *IBM PC-XT* computer. Data were entered and manipulated with *dBASE III+* and *foxBASE+* database management programs. Two large computer

programs (*CHARTS* and *CRETAB*) written in C analyzed the geographic and temporal distribution of resightings and calculated annual population estimates using the Bailey modification of the Petersen two-sample estimator (Seber, 1982; Begon, 1979; Hammond, 1986).

The number of whales added to the North Atlantic humpback whale fluke catalog during the period 1976-1987 is shown in Fig. 1. Occasionally two photographs thought to be of different whales were subsequently judged to represent the same animal. The rate of discovery of these errors (Fig. 2) has declined significantly since record keeping started in October 1985, and it does not appear likely that any remaining duplicates would seriously affect the results discussed below.

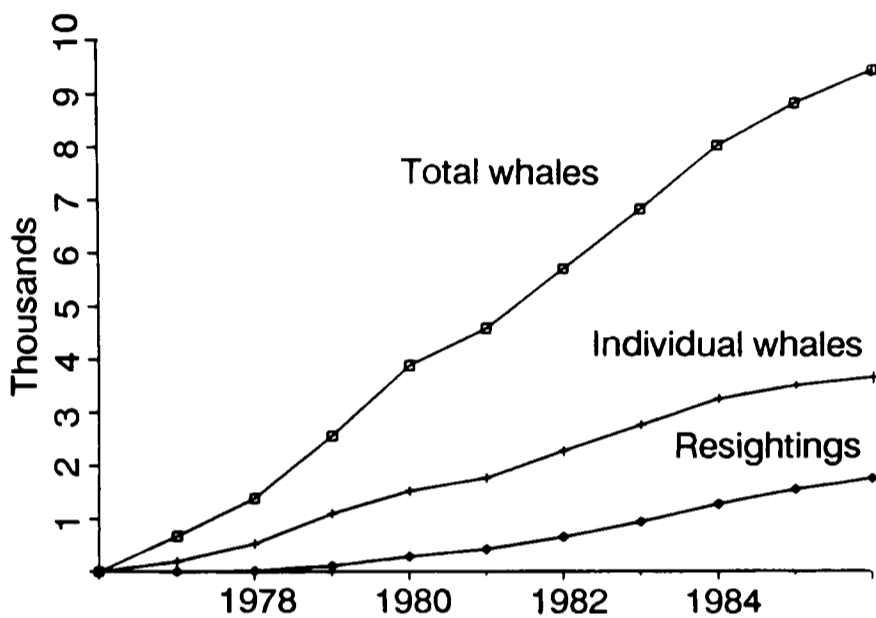

Fig. 1. Growth of North Atlantic Humpback Whale Catalog, 1976-1986, including total number of photographs curated, total number of individually-identified whales and total number of resightings for each year.

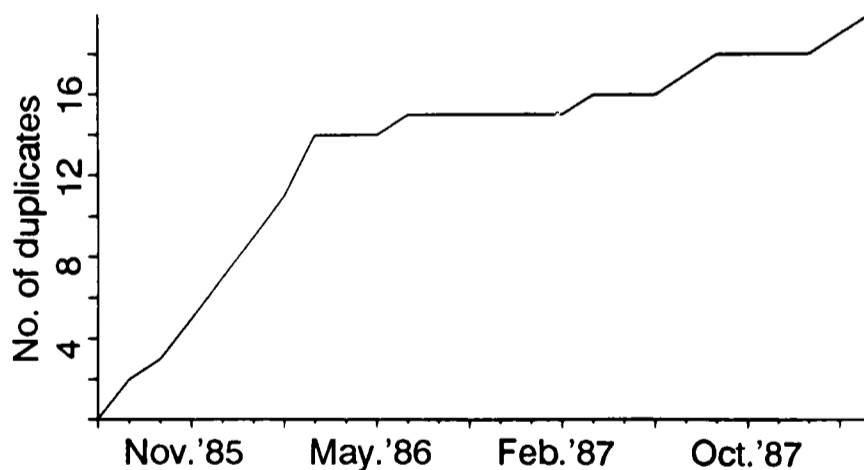

Fig. 2. Rate of discovery of duplication errors in the North Atlantic Humpback Whale Fluke Catalog.

Humpback whales were photographed in six regions of the North Atlantic where they feed during spring through autumn (European coast; Iceland-Denmark Strait; western Greenland; Newfoundland (including the Labrador coast); Gulf of St. Lawrence; Gulf of Maine-Scotian Shelf). The number of whales photographed in each region as of December 31 1986, is shown in Table 1, along with the percentages known from photographs of the whole flukes (Type 1), left half of the fluke only (Type 5), or right half of the fluke only (Type 6). Also shown for each area is the number of individuals photographed only as calves.

Table 1

Geographic distribution of identified humpback whales as of December 31, 1986. Table includes numbers (and percentages) of whales identified by photographs of whole flukes (Type 1), left halves only (Type 5), and right halves only (Type 6) of acceptable photographic quality (Q1 = excellent, Q2 = good, Q3 = included in migration studies, but excluded from population estimates).

	Type 1	Type 5	Type 6	Calves
Northeast Atlantic	10 (0%)	0 (0%)	1 (0%)	0 (0%)
Iceland	20 (1%)	0 (0%)	0 (0%)	0 (0%)
Greenland	149 (4%)	2 (0%)	3 (0%)	8 (0%)
Newfoundland	1,432 (40%)	7 (0%)	8 (0%)	4 (0%)
Gulf of St. Lawrence	121 (3%)	0 (0%)	0 (0%)	2 (0%)
Gulf of Maine	505 (14%)	9 (0%)	13 (0%)	47 (1%)
Southeast coast USA	2 (0%)	0 (0%)	1 (0%)	0 (0%)
Bermuda	107 (3%)	4 (0%)	3 (0%)	-
Dominican Republic	975 (30%)	58 (2%)	74 (2%)	-
Puerto Rico	461 (13%)	4 (0%)	3 (0%)	-
Virgin Bank	103 (3%)	3 (0%)	7 (0%)	-
Total	3,885 (95%)	87 (2%)	112 (3%)	61 (1%)

We estimated the size of the humpback whale population in the western North Atlantic Ocean and subregions using the Bailey modification of the Petersen two sample capture-recapture estimator, as discussed by Seber (1982, pp.61-4) and Begon (1979, pp.6-9):

$$\hat{N}_1 = n_1(n_2+1)/(m_2+1)$$

$$V_1 = \frac{n_1^2(n_2+1)(n_2-m_2)}{(m_2+1)^2(m_2+2)}$$

$$V_1 = \frac{n_1^2(n_2+1)(n_2-m_2)}{(m_2+1)^2(m_2+2)}$$

where:

\hat{N}_1 = estimated population size

n_1 = number of individuals identified from photographs in sample 1

n_2 = number of individuals identified from photographs in sample 2

m_2 = number of individuals identified from photographs in both sample 1 and sample 2

V_1 = estimated variance of N_1 .

This method allows for replacement of sampled individuals (Hammond, 1986). Similar techniques have been applied to photographic resightings of individual humpback whales by Perkins and Whitehead (1978), Balcomb and Nichols (1978), Whitehead (1982), Darling *et al.* (1983), Perkins *et al.* (1984), Balcomb, Katona and Hammond (1986) and Baker and Herman (1987).

Population estimates for the entire western North Atlantic (Fig. 3) used as n_1 the total number of individuals identified from photographs in all northern feeding regions during one summer; n_2 , the total number of individuals identified from photographs in all southern breeding regions during the following winter; and m_2 the number of individuals identified from photographs in both samples. Three different population estimates based on slightly different datasets are shown for each year. 'Type 1' estimates used when possible (e.g. Type 1,5 in year 1985). Whales known only by photographs of the left half of the fluke were never compared with whales known only by photographs of the right side of the fluke. Values for n_1 , n_2 and m_2 for all datasets are given in Table 5.

We eliminated from these analyses all animals photographed as newborn calves on the breeding ground; their photographs are often poor since they rarely fluke up and their fluke patterns are ill-defined or variable

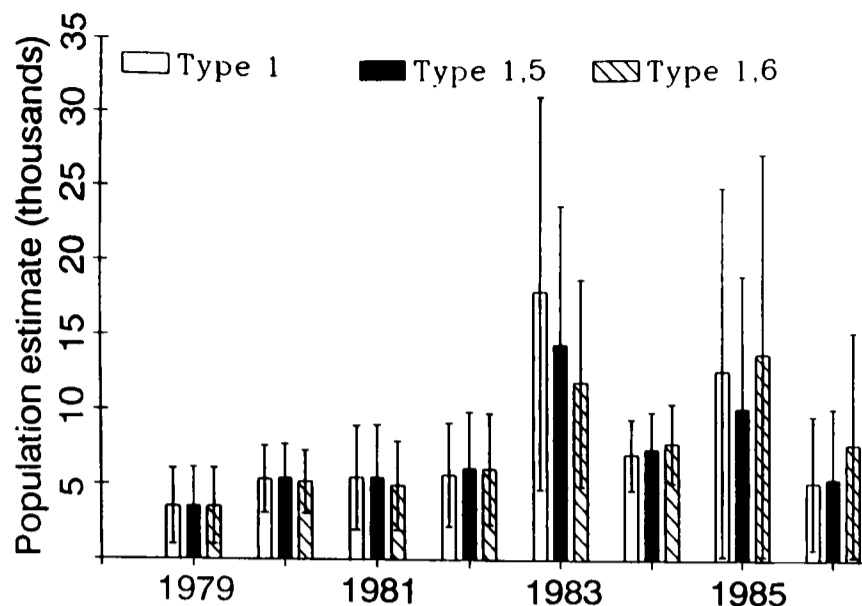

Fig. 3. Population estimates for western North Atlantic Ocean based on pooled photographs from all northern feeding aggregation regions as n_1 . Three partly independent estimates are shown, drawn from datasets for whole flukes (Type 1); whole flukes plus left fluke halves (Types 1,5); and whole flukes plus right fluke halves (Types 1,6).

(Carlson, Mayo and Whitehead, 1990). Our analyses did include animals first photographed as calves on the feeding grounds, since their fluke patterns are better developed, they fluke up more frequently, and their resighting percentage is good (40 of 110 animals, 36%).

For each year we selected the population estimate with smallest standard error (Table 5, Table 6) and used it to calculate variance-weighted means and their variances (Sokal and Rohlf, 1981, pp.41–43; also see Begon, 1979, pp.13–16). A variance-weighted mean minimizes the importance of outlying data points, such as the unexplainably high population estimates calculated for years 1983 and 1985 (Tables 5 and 6).

We also computed annual population estimates for the separate feeding aggregations and breeding range subregions in the western North Atlantic. For example, to compute a population estimate for the Gulf of Maine for year 1979 we used:

n_1 = number of individuals identified from photographs taken in the Gulf of Maine in 1978;

n_2 = number of individuals identified from photographs taken in the Gulf of Maine in 1979;

m_2 = number of individuals identified from photographs taken in the Gulf of Maine both in 1978 and 1979.

Estimates were independent from year to year, because they were based on different photographic samples. Variance-weighted means and their variances were computed (Table 7) after selecting annual estimates with the lowest standard errors.

RESULTS AND DISCUSSION

(1) Probable feeding-group aggregations of the North Atlantic humpback whale population

Analysis of 643 individuals resighted in particular subregions of the feeding range after intervals of one year or more (Table 2) showed that relatively high percentages of whales returned to the same feeding locations during different years. These values are highest for northern regions which have been studied intensely and have humpback whale populations of several hundred animals or so (Table 1; see Table 7), namely the Gulf of Maine (56%), western Greenland (28%) and the Gulf of St.

Table 2

Summary of geographic distribution of resightings of individually-identified humpback whales on the feeding range.

A. Number of whales returning to same feeding region in more than one feeding season.

	No.	%
Iceland	1	5
Greenland	43	28
Newfoundland	211	15
Gulf of St. Lawrence	30	25
Gulf of Maine/Scotian Shelf	294	56

B. Number and subset index, S , of whales resighted in different feeding areas.

	No.	S
Gulf of St. Lawrence and Greenland	1	0.01
Gulf of St. Lawrence and Newfoundland	12	0.11
Gulf of St. Lawrence and Gulf of Maine	10	0.10
Gulf of Maine and Newfoundland	3	0.01

Lawrence (25%). Newfoundland humpbacks had a lower resighting percentage (15%), probably because they were not studied intensively after 1982 and because the population appears to include several thousand whales.

A total of 26 individuals were resighted in more than one feeding subregion (Table 2), but expression of the fraction of whales that moved between feeding locations is confounded by differences in photographic sample sizes and population sizes. We have used the formula:

$$S = C/A + C/B$$

where,

A = photographic sample size for first region (Table 1);

B = photographic sample size for second region (Table 1);

and

C = no. of animals observed in both regions (Table 2B).

The expression, S , which we call the 'subset index', then varies from 0 (no interchange) to 2 (all animals migrate between locations A and B). If either term of the expression approaches 1, the corresponding region can be considered a subset of the other region. Evaluation of movement between feeding aggregations points out regions from which whales could potentially replenish an extirpated humpback population and gives a relative indication of how long the process might take.

No movement of whales was detected between Iceland and/or Greenland and/or Newfoundland (Table 2). Since those regions also had moderately high between-year within-region resighting percentages, their humpback populations can be regarded as distinct feeding aggregations. The Gulf of Maine-Scotian Shelf region can be considered a fourth aggregation unit based on its very high (56%) between-year within-region resighting percentage. Three individuals from this region have also been seen in Newfoundland ($S=0.01$), but no other interchange has been observed thus far between this region and the three regions above. The last major northern region for which we have adequate photographs, the Gulf of St. Lawrence, appears to be a fifth aggregation unit. Its high (25%) between-year within-region resighting

percentage shows that a population of whales returns regularly. However, 10 individuals have been seen in both the Gulf of St. Lawrence and the Gulf of Maine ($S=0.10$); 12 different whales have been seen in the Gulf of St. Lawrence and in Newfoundland waters ($S=0.11$); and one other whale has been seen in the Gulf of St. Lawrence and near Greenland ($S=0.01$), so the status of this region is somewhat more complex.

Table 3

Summary of geographic distribution of north-south migrations of individually-identified humpback whales and distribution on the breeding range. N = number of individuals and S = subset index for whales seen in more than one region. Values shown as percentages are actual percentages of whales returning to the same region in more than one year.

A. Number (and percentage) of whales returning to same southern region in more than one breeding season.

	No.	%		No.	%
Bermuda	4	4	Puerto Rico	26	6
Dominican Republic	63	6	Virgin Islands	1	1

B. Movement of whales between southern regions, expressed as S = subset index.

	Bermuda		Dom. Rep.		P. Rico	
	No.	S	No.	S	No.	S
Dominican Republic	12	0.12				
Puerto Rico	6	0.07	42	0.13		
Virgin Bank	3	0.05	11	0.11	10	0.11

C. Migratory movements of whales from different feeding aggregations to southern regions, expressed as S = subset index.

	Bermuda		Dom. Rep.		P. Rico		Virgin Bank	
	No.	S	No.	S	No.	S	No.	S
Iceland	1	0.06	1	0.05	4	0.21	0	—
Greenland	2	0.03	17	0.13	1	0.01	4	0.06
Newfoundland	14	0.13	157	0.25	65	0.18	10	0.10
G. of St. Lawrence	1	0.02	13	0.12	12	0.12	1	0.02
Gulf of Maine	8	0.09	32	0.09	17	0.07	2	0.02

(2) North-south migrations of individually-identified humpback whales

Humpback whales were photographed in three regions where they breed during winter (Dominican Republic; northwest coast of Puerto Rico; and Virgin Islands); and also at one location, the Bermuda Islands, which they pass during the northward migration in spring. We combined photographs from Navidad Bank (29), Mouchoir Bank (1), Nechir Passage (1), and Samana Bay (13) with those from Silver Bank (1,072) and listed the total (1,107) as Dominican Republic. (The total is less than the sum of the subregions, due to inter-region resightings of several whales). Although it is not yet known whether whales exchange freely between these four locations, two individuals were photographed at Samana Bay and at Silver Bank; and four others were photographed at both Navidad and Silver Banks. Balcomb and Nichols (1978) hypothesized that whales moved west from Navidad Bank to Silver Bank to Mouchoir Bank as the season progressed.

Identified individuals from all five of the postulated feeding aggregations migrated to the breeding range during winter (Table 3). Whales from Newfoundland had the highest interchange with the Dominican Republic ($S=0.25$), Virgin Bank ($S=0.10$), and with Bermuda ($S=0.13$) during northward migration, but whales from Greenland showed slightly higher interchange with Puerto Rico ($S=0.21$).

Some movement of identified individuals occurred between the Dominican Republic, Puerto Rico and the Virgin Bank (Table 3), with subset coefficients ranging from $0.11 < S < 0.13$.

We calculated log-likelihood ratios (G test, Zar, 1984, pp.53–4) to test hypotheses about movement patterns of whales from the different feeding aggregations (Table 4).

There was significant deviation from the hypothesis that whales from the five feeding aggregations visited the southern breeding range in proportion to the size of our photographic samples ($G=12.563$, $df=4$, $0.01 < p < 0.025$). In this analysis photographs from all locations south of the Bahamas were lumped as the 'breeding range'. Comparison of observed values with expected values suggested that whales from Newfoundland-Labrador were over-represented on the breeding range while those from the Gulf of Maine were under-represented.

Table 4

Log-likelihood tests for migration of individually-identified humpback whales in proportion to the sizes of photographic samples from feeding aggregations.

Area	Breeding range		Dominican Rep.		Puerto Rico		Virgin Bank		Bermuda			
	Obs	Exp	Obs	Exp	Obs	Exp	Obs	Exp	Obs	Exp		
Iceland		20	4	2.8	1	1.9	4	0.9	0	0.1	1	0.2
Greenland		154	20	21.5	17	14.8	1	6.7	4	1.1	2	1.8
Newfoundland/Labrador		1,443	226	202.2	157	138.3	65	63.0	10	10.3	141	6.6
Gulf of St. Lawrence		107	18	16.9	8	10.3	12	4.7	1	0.8	1	1.4
Gulf of Mexico/Nova Scotia		519	51	73.6	32	49.7	16	22.7	2	3.7	8	6.0
Total		2,243	319		215		98		17		26	

G-Statistic:

->Breeding range	$G = 12.563$	$df=4$	$(0.025) < p < (0.01)$	significant
->Dominican Republic	$G = 11.068$	$df=4$	$(0.05) < p < (0.025)$	significant
->Puerto Rico	$G = 23.788$	$df=4$	$p < (0.001)$	significant
->Virgin Bank	$G = 5.776$	$df=4$	$(0.25) < p < (0.10)$	not significant
->Bermuda	$G = 2.546$	$df=4$	$(0.75) < p < (0.50)$	not significant

There was also significant deviation from the hypothesis that whales from the five feeding aggregations migrated to the major breeding location, the Dominican Republic, in proportion to the size of our photographic samples ($G=11.068$, $df=4$, $0.025 < p < 0.05$). Previous work has indicated that a portion of this region, Silver Bank, may host up to 85% of western North Atlantic breeding humpbacks (Winn, Edel and Taruski, 1975; Balcomb and Nichols, 1978) and 96% of our Dominican photographs come from that location. Current evidence suggests that whales from all five feeding aggregations interbreed at Silver Bank, at least, since 75% of the eight surface-active courtship groups observed there containing two or more whales known from the northern range included individuals from two different feeding aggregation regions (Mattila, Clapham, Katona and Stone, 1989). Whales from Newfoundland-Labrador were again somewhat over-represented and those from the Gulf of Maine were under-represented.

Finally, there was significant deviation ($G=23.788$, $df=4$, $p < 0.001$) from the hypothesis of proportional migration to Puerto Rico. Whales from both Iceland and the Gulf of St. Lawrence were over-represented at Puerto Rico, while whales from Greenland and the Gulf of Maine were under-represented.

There was no significant deviation from the hypothesis of proportional migration from the five feeding aggregations to the Virgin Bank ($G=5.776$, $df=4$, $0.01 < p < 0.25$), although it appeared that whales from Greenland were over-represented there.

There was also no deviation from the hypothesis that whales from the five feeding aggregations migrated north past Bermuda in proportion to the size of our photographic samples ($G=2.546$, $df=4$, $0.5 < p < 0.75$). Stone *et al.* (1987) and R. Payne (pers. comm.) have suggested that the number of humpbacks seen off Bermuda may have declined in recent years. If so, sightings of whales from all feeding aggregations have declined proportionally.

Our interpretation of these data is that the North Atlantic humpback whale population comprises at least five relatively distinct feeding aggregations which return regularly to the same feeding regions year after year. Whales from all of the northern regions west of the Mid-Atlantic Ridge winter in the Antilles, but there is some evidence for non-homogeneous representation and distribution both on the breeding range as a whole and around the Dominican Republic and Puerto Rico. We do not yet have explanations for these deviations from expected random distribution. During the northern migration following breeding, separation into different feeding aggregations apparently does not occur until the whales are north of Bermuda ($32^{\circ}30'N$).

We emphasize that the current model envisions the entire western North Atlantic population of humpback whales as one genetic stock. Additional photographs from the eastern Atlantic, Europe and the Cape Verde Islands are needed to assess potential gene flow across the entire North Atlantic basin. Feeding aggregations maintain their geographic fidelity culturally, rather than genetically, calves learning the migration routes from their mothers, then passing them on to their own calves. Even though most of the animals in our 12 year study have shown geographic fidelity, individuals are probably not permanently bound to their feeding aggregations and a certain amount of wandering may be expected in response to changing conditions during their relatively long

lifetimes. For example, Gulf of Maine-Gulf of St. Lawrence interchange, first seen in 1983, could represent spillover from population increase in the Gulf of Maine or dispersal related to changing abundances of prey species.

(3) Population estimate for the western North Atlantic Ocean

Using data from Table 5, our variance-weighted mean for years 1979–86 was $5,505 \pm 2,617$ (95% CI). This estimate is within the 2,000–6,000 range suggested by Whitehead (1982) using a closely-related technique. The confidence interval includes the estimate of 4,400 to 4,700 humpbacks calculated by Mitchell and Reeves (1983) on the basis of cumulative catch data as a minimum number of humpback whales existing in the North Atlantic Ocean in the year 1865.

Table 5

Summary of annual population estimates and standard deviations computed using Bailey's modification of the Petersen capture-recapture technique, along with corresponding values of n_1 , n_2 and m_2 . Photographs from the entire feeding range were pooled as n_1 . Three partly independent estimates were calculated for each year, drawn from the datasets for whole flukes (Type 1); whole flukes plus left fluke halves (Types 1, 5); and whole flukes plus right fluke halves (Types 1, 6). For each year the estimate with lowest standard error, indicated by an asterisk (*), was selected for calculation of variance-weighted means (see text).

		n_1	n_2	m_2	N	SE
1979	T1	294	71	5	3,528	1,277*
	T1,5	294	72	5	3,577	1,295
	T1,6	295	71	5	3,540	1,281
1980	T1	539	188	18	5,362	1,137
	T1,5	544	189	18	5,440	1,154
	T1,6	542	190	19	5,176	1,069*
1981	T1	382	113	7	5,444	1,750
	T1,5	384	113	7	5,472	1,759
	T1,6	384	114	8	4,907	1,490*
1982	T1	234	214	8	5,590	1,730*
	T1,5	237	228	8	6,030	1,869
	T1,6	238	225	8	5,976	1,852
1983	T1	478	224	5	17,925	6,684
	T1,5	480	239	7	14,400	4,719
	T1,6	481	245	9	11,833	3,494*
1984	T1	500	433	30	7,000	1,192*
	T1,5	507	465	31	7,383	1,240
	T1,6	505	475	30	7,754	1,325
1985	T1	271	139	2	12,647	6,255
	T1,5	275	147	3	10,175	4,488*
	T1,6	276	149	2	13,800	6,831
1986	T1	330	62	3	5,198	2,249*
	T1,5	330	65	3	5,445	2,360
	T1,6	332	69	2	7,747	3,789

It is somewhat higher than previous estimates, as summarized by Whitehead (1982) and Balcomb and Nichols (1982). Estimates for the total population of humpback whales in the western North Atlantic have increased substantially in the past twenty years, but this could result partly from improved census techniques as well as actual growth of the population. Early estimates of 1,259 whales (Mitchell, 1973) and 785 to 1,157 whales (Winn *et al.*, 1975) were probably low for methodological reasons.

Table 6

Selected annual population estimates and variances for feeding substock regions and breeding range, computed using Bailey's modification of the Petersen capture-recapture technique, along with corresponding values of n_1 , n_2 and m_2 . Three partly independent estimates were calculated for each year, drawn from the datasets for whole flukes (Type 1); whole flukes plus left fluke halves (Types 1, 5); and whole flukes plus right fluke halves (Types 1, 6). For each year the estimate with lowest standard error, (*), was selected for calculation of variance-weighted means (Table 7).

		n_1	n_2	m_2	N	SE			n_1	n_2	m_2	N	SE
<i>Greenland</i>						<i>Iceland</i>							
1982	Type 1	68	63	23	181	29*	1982	Type 1	2	17	1	18	10*
	Type 1,5	69	63	23	184	29		Type 1,5	2	17	1	18	10
	Type 1,6	68	64	23	184	29		Type 1,6	2	17	1	18	10
1983	Type 1	63	59	15	236	49	<i>Gulf of St. Lawrence</i>						
	Type 1,5	63	60	16	226	45*	1983	Type 1	41	31	8	146	39*
	Type 1,6	64	59	15	240	50		Type 1,5	41	31	8	146	39
								Type 1,6	41	31	8	146	39
<i>Newfoundland</i>						<i>Bermuda</i>							
1978	Type 1	22	267	2	1,965	977*	1985	Type 1	18	22	3	104	42*
	Type 1,5	22	267	2	1,965	977		Type 1,5	18	22	3	104	42
	Type 1,6	22	268	2	1,973	981		Type 1,6	18	22	3	104	42
1979	Type 1	267	480	39	3,211	480	<i>Dominican Republic</i>						
	Type 1,5	267	482	40	3,145	464*	1978	Type 1	12	34	1	210	118*
	Type 1,6	268	482	39	3,236	484		Type 1,5	14	35	1	252	141
1980	Type 1	480	256	50	2,419	300*		Type 1,6	12	35	1	216	121
	Type 1,5	482	258	50	2,448	304	1981	Type 1	95	27	2	887	419*
	Type 1,6	482	258	50	2,448	304		Type 1,5	96	27	2	896	423
1981	Type 1	256	52	6	1,938	638*		Type 1,6	97	27	2	905	428
	Type 1,5	258	52	6	1,953	643	1982	Type 1	27	164	2	1,485	736*
	Type 1,6	258	52	6	1,953	643		Type 1,5	27	175	2	1,584	785
1982	Type 1	52	204	3	2,665	1,180*		Type 1,6	27	173	2	1,566	776
	Type 1,5	52	206	3	2,691	1,192	1984	Type 1	130	378	6	7,039	2,465*
	Type 1,6	52	206	3	2,691	1,192		Type 1,5	144	410	6	8,455	2,964
1983	Type 1	204	259	27	1,894	332		Type 1,6	150	420	7	7,894	2,606
	Type 1,5	206	264	28	1,882	324*	1985	Type 1	378	112	6	6,102	2,089
	Type 1,6	206	260	27	1,920	337		Type 1,5	410	119	7	6,150	1,980
1984	Type 1	259	10	1	1,425	744*		Type 1,6	420	121	8	5,693	1,733*
	Type 1,5	264	10	1	1,452	758	<i>Puerto Rico</i>						
	Type 1,6	260	10	1	1,430	747	1979	Type 1	10	63	2	213	104*
<i>Gulf of Maine</i>						<i>Puerto Rico</i>							
1978	Type 1	20	26	3	135	56*		Type 1,5	10	64	2	217	106
	Type 1,5	20	26	3	135	56		Type 1,6	10	63	2	213	104
	Type 1,6	20	26	3	135	56	1980	Type 1	63	96	3	1,528	669*
1979	Type 1	26	58	12	118	28*		Type 1,5	64	96	3	1,552	680
	Type 1,5	26	61	12	124	29		Type 1,6	63	96	3	1,528	669
	Type 1,6	26	59	12	120	28	1981	Type 1	96	86	2	2,784	1,368*
1980	Type 1	58	124	42	169	21		Type 1,5	96	86	2	2,784	1,368
	Type 1,5	61	124	44	169	20*		Type 1,6	96	87	2	2,816	1,384
	Type 1,6	59	125	44	165	20	1982	Type 1	86	49	4	860	333*
1981	Type 1	124	114	75	188	12*		Type 1,5	86	52	4	912	345
	Type 1,5	124	116	75	191	13		Type 1,6	87	51	4	905	351
	Type 1,6	125	117	77	189	12	1983	Type 1	49	91	1	2,254	1,287
1982	Type 1	114	150	81	210	16		Type 1,5	52	92	1	2,418	1,381
	Type 1,5	116	150	83	209	15*		Type 1,6	51	92	2	1,581	778*
	Type 1,6	117	150	81	215	16	1984	Type 1	91	56	3	1,297	559*
1983	Type 1	150	156	98	238	14		Type 1,5	92	56	3	1,311	565
	Type 1,5	150	157	98	239	15		Type 1,6	92	56	3	1,311	565
	Type 1,6	150	159	100	238	14*	<i>Greenland</i>						
1984	Type 1	156	216	120	280	17*	1982	Type 1	68	63	23	181	29*
	Type 1,5	157	220	122	282	17		Type 1,5	69	63	23	184	29
	Type 1,6	159	221	122	287	17		Type 1,6	68	64	23	184	29
1985	Type 1	216	266	151	379	20	1983	Type 1	63	59	15	236	49
	Type 1,5	220	266	154	379	20*		Type 1,5	63	60	16	226	45*
	Type 1,6	221	268	153	386	20		Type 1,6	64	59	15	240	50
1986	Type 1	266	236	140	447	24*	<i>Newfoundland</i>						
	Type 1,5	266	239	140	453	24	1978	Type 1	22	267	2	1,965	977*
	Type 1,6	268	241	140	460	25		Type 1,5	22	267	2	1,965	977
								Type 1,6	22	268	2	1,973	981

(4) Growth of annual population estimates for western North Atlantic Ocean

Least-squares regression lines computed using the natural logarithm of annual population estimates with lowest standard errors yielded the equation $y=8.3129+0.0942x$ ($r^2=0.33$, 95% CI of slope=-0.12 to 0.30) for years 1979–1986. This equation suggests an annual rate of increase of 9.4% for the North Atlantic humpback population during those years, but the confidence interval around that slope is broad. However, this value is comparable to the value of 11.6% (SE 0.020) obtained for humpback whales off Iceland from sightings data collected from 1970–88 by Sigurjónsson and Gunnlaugsson (1990). Chittleborough's (1965) best estimate for the rate of annual increase of Southern Hemisphere humpback whales was 4.6%, based on pregnancy rates of hunted specimens. Given the magnitude of standard errors in our annual population estimates and the relatively low rates of expected annual growth of a baleen whale population, detection of population trends will require at least a decade.

(5) Population estimates for feeding aggregations and breeding regions

Population estimates for feeding aggregations and breeding regions are shown in Tables 6 and 7. Other workers have made previous estimates for some of those regions, but since most have submitted photographs to our collection, only those estimates not based on fluke photography provide independent values for comparison.

Perkins *et al.* (1984) obtained an estimate of 282 ± 76 (95% CI) individuals for the 1983 western Greenland humpback population using the Chapman modification of the Petersen method. Our variance-weighted mean of 194 ± 284 (95% CI) for 1982 and 1983 used those and other photographs.

Table 7

Variance-weighted means for estimated humpback whale populations of regions of the North Atlantic feeding and breeding range, calculated after selecting annual estimates with lowest standard errors from Table 6. Any estimates in which m_2 equalled 0 or 1 were not used in calculations.

	Wt. mean	95% CI	
Iceland	—	—	(no reliable estimate)
Greenland	194	284	
Newfoundland	2,310	580	
Gulf of St. Lawrence	155	61	
Gulf of Maine	240	93	
Bermuda	104	—	(only one annual estimate)
Dominican Republic	1,349	5,604	
Puerto Rico	359	985	
Virgin Bank	—	—	(no reliable estimate)

Whitehead's (1982) five estimates for the Newfoundland-Labrador region in years 1978 and 1979 ranged from 1,955 to 3,093, providing a mean of 2,470. Our variance-weighted mean of $2,310 \pm 580$ (95% CI) for the same region for years 1978–1983 (Tables 6 and 7) is within that range. All of Whitehead's photographs are included in our collection, and although they make up the bulk of photographs from Newfoundland-Labrador, our database also includes photographs from other sources that were not used in his analyses.

No independent data are available from the Gulf of St. Lawrence for comparison with our variance-weighted mean of 155 ± 61 (95% CI) whales.

Using data from aerial surveys carried out during 1979–81, CeTAP (1982) estimated the mean number of humpbacks in US continental shelf waters from Cape Hatteras to southern Nova Scotia to be 658 ± 590 (95% CI) during Spring, the period of maximal abundance. Most of the animals observed during sampling were located above latitude 41°N , as indicated by the population estimate of 555 ± 734 (95% CI) for the Gulf of Maine during that same period. The maximum point abundance estimate was $827 \pm 2,266$ (95% CI) in the Gulf of Maine, July 1979. All of these estimates were considerably higher than comparable capture-recapture estimates we computed for those years or for our variance-weighted mean, 240 ± 93 (95% CI) for 1978–86. Our highest annual capture-recapture estimate for the Gulf of Maine was 447, computed for 1986. Possible reasons why the CeTAP estimates are higher than those reported here could be: (1) the aerial survey covered offshore waters from which we did not receive photographs; or (2) some of the humpbacks observed by CeTAP may have been migrating to other feeding grounds near Nova Scotia or even the Gulf of St. Lawrence, and might not have been available during the n_2 sample. It should also be recognised that the CeTAP estimates have very wide confidence intervals that include our capture-recapture estimates.

Our population estimates for regions of the breeding range are problematical, because they show much more variation between years than do estimates for feeding regions (Table 6). However, we have at present no clear basis for eliminating particular estimates from our calculation of overall means. An unweighted population mean for the Dominican Republic, $3,776 \pm 4,853$ (95% CI), may be a better estimate than our variance-weighted mean, $1,349 \pm 5,604$ (Table 7), although both used annual capture-recapture estimates with lowest standard errors for years 1981, 1982, 1984 and 1985 (Table 6). The number of resightings, m_2 , was only two in the 1981 and 1982 estimates, but was six in the 1984 and 1985 estimates. If the first two years could be dropped, the mean for the two recent years, both of which had much higher effort, would be much closer to our overall estimates for the total western North Atlantic population.

Several other population estimates for portions of the breeding range are available for comparison. Whitehead (1982) used shipboard strip census surveys to estimate a peak population of 2,000–3,500 humpback whales for Silver, Navidad and Mouchoir Banks combined during 1978. At least 70% of those whales were found on Silver Bank and 5% or less were on Mouchoir Bank. Using similar methods, but a different ship, Scott and Winn (1980) found 1,375 to 1,747 (95% CI) humpbacks on Silver and Navidad Banks combined during the first two weeks of March 1978. Balcomb and Nichols (1982) performed strip census transects on Navidad and Silver Banks over the whole breeding season in 1980, using methods similar to those of Whitehead (1982). Peak numbers of whales occurred on Navidad Bank in late January 1980, and two weeks later on Silver Bank. The combined peak population computed for 1980 was 1,923 whales, but similar surveys in 1981 yielded only 1,177.

Differences in these various estimates suggest the possibility that the humpback population on Silver Bank may not be identical each year. Whales of different age classes or reproductive states could differ in spatial distribution over the whole breeding range, total time spent on Silver Bank, or in other ways (Mattila *et al.*,

1989). These hypotheses are of some importance, since they will affect the design and interpretation of future population studies.

A population estimate is available for only one other breeding location, the Virgin Bank. Winn *et al.* (1975) used observation and acoustic censusing to estimate a population of 8–16 humpbacks on the Virgin Bank during the mid-1970s, but Mattila and Clapham (1987) observed 70 humpbacks and recorded transect densities of 0.02–0.04 whales per square kilometer.

It is clear from historical sources (Mitchell and Reeves, 1983) that humpbacks used to be present in some numbers throughout the Lesser Antilles all the way to Venezuela. For example, Mitchell and Reeves found that 20 whaling stations operated in the Grenadine Islands during some part of the period 1875–1920, killing approximately 44 humpbacks annually during the years 1880 to 1913. Between 1924 and 1926 about 174 humpbacks were killed in Grenada. From 1950–1984 the land-based whaling station at Bequia, St. Vincent, landed only 44 whales and lost 10 (Price, 1985). A three-week expedition to photograph humpback flukes at Bequia during winter 1984, encountered only one whale (S. Mayo, pers. comm.).

Considering the paucity of humpback sightings elsewhere on the breeding range, the total number of whales in the Dominican Republic, Puerto Rico and Virgin Bank is a reasonable estimator of the humpback population on the winter range. No published evidence exists to suggest that many humpbacks fail to migrate to the southern breeding range during winter, although occasional late-season high-latitude records are available for Newfoundland (Williamson, 1961; Sergeant, 1966; J. Lien, pers. comm.) and the Gulf of Maine (P. Clapham, pers. comm.; C. Haycock, pers. comm.).

(6) Further discussion of capture-recapture methods

Photographic capture-recapture techniques are more efficient and precise than previous techniques used to estimate humpback whale population size in the western North Atlantic (cumulative catch, Mitchell and Reeves, 1983; summer-range shipboard strip census transects, Mitchell, 1974; aerial census surveys, Scott and Winn, 1980 and Scott *et al.*, 1981).

The modified capture-recapture technique employed here is the most practical method currently available for our data for reasons discussed by Hammond (1986). Underlying assumptions for proper use of the method (Seber, 1982, p.59) are:

- (a) the population is closed, i.e. the number of animals present is constant;
- (b) all individuals have an equal probability of being caught (i.e. photographed) in the first sample;
- (c) marking (photographing) does not affect 'catchability' of the animal in subsequent samples;
- (d) the second sample is a simple random sample;
- (e) animals do not lose marks in the time between samples, i.e. fluke markings do not change substantially over time;
- (f) all marks are reported on recovery in the second sample, i.e. animals previously photographed are successfully recognized in later photographs.

Since Begon (1979) provided a useful general discussion of these assumptions, and Hammond (1986) discussed their validity in photo-identification studies of whales, we will only briefly mention several additional considerations.

The first assumption (a), closed population, is probably not seriously violated. The humpback whales we studied probably did not leave the North Atlantic Ocean, although they are probably physically capable of doing so (Katona, 1986). None of 23 humpbacks photographed along the western side of the Palmer Peninsula, Antarctica, matched any of the individuals in our North Atlantic catalog (Stone and Hamner, 1988). Analysis of humpback song dialects also suggests that each ocean contains a single population of whales, distinct from those in other basins (Payne and Guinee, 1983, Winn *et al.*, 1981). Failure of many whales to perform the regular north-south migrations discussed above would introduce significant bias, as would movement to locations where they are not adequately sampled. We have no evidence that either of these phenomena occurs to a significant degree. Another violation of assumption (a) would occur if mortality or natality occurred between samples but since our samples are separated by less than one year, both factors will usually be small. Photographing a whale does not directly affect its mortality so there should be no difference between marked and unmarked whales. However for the Newfoundland samples, many animals released from entrapment in coastal fishing gear have been photographed over the past five years. If those animals have increased tendencies to become entangled in future years, owing to habitat choice, feeding method or other factors, then their availability in the subsequent sample may, in effect, be reduced if they are more likely to die (however it will be increased if they are more likely to become entrapped again and thus photographed).

The second assumption (b), equal catchability in first sample, is probably violated in some cases, as discussed by Hammond (1986). Hammond (1990) found evidence that capture probabilities were not equal within our data set for the Gulf of Maine and described a method for minimizing this heterogeneity.

Assumption (c), that marking does not affect catchability, is probably valid. Photographing a whale on one occasion does not, *per se*, make that whale easier to photograph at a later time, but it is possible that some whales in an area frequented intensively by whale watching cruises could become habituated or attracted to the boats, so that they would be photographed more frequently. Such behavior might have the best chance of developing in the southern Gulf of Maine, where the whale watching industry has been most intensive. To affect the population estimate, that behavior would need to reoccur several months later on the southern range. We think this unlikely, since in our experience, such behavior tends to be 'vessel specific', as if the whales recognized a particular boat or type of boat from its sounds or underwater appearance. Diesel-powered vessels up to 30m long, often with several engines, are used most frequently for whale watch cruises in locations where whales might develop habituation. In contrast, large (over 30m) auxiliary-powered sailboats, 10m sailboats and inflatable boats powered by outboard engines have been used during studies on the southern range. A paired-sample test for comparison of paired means (Zar, 1984, pp.150–3) revealed no significant difference in the mean number of times that individual whales which comprised the m_2 recaptures in our annual population estimates had been photographed compared to other whales in the corresponding n_1 samples ($t=-0.398$, $df=8$, $p>0.50$). This was also true for comparisons with corresponding n_2 samples ($t=0.237$, $df=8$, $p>0.50$).

Assumption (d), random second sample, is violated because the entire range is not sampled either randomly or evenly. Hammond (1990) demonstrated that heterogeneity introduced as a result of unrepresentative sampling can be accounted for but this does not eliminate all the problems of violating this assumption.

We are confident that assumption (e), successful recognition of marked animals in the second sample, is valid. Although fluke patterns of some individuals may darken considerably during the first several years of life and new environmentally-induced markings (wounds, killer whale teeth marks, etc.) may be gained, experienced researchers can still identify individuals by the shape of the trailing margin of the fluke and any constant pattern elements (Carlson, Mayo and Whitehead, 1990).

Whitehead (1982), Hammond (1986) and Perkins *et al.* (1984) evaluated the possible effects of assumption violations on the Petersen capture-recapture method. Whitehead (1982) concluded that the Petersen capture-recapture method probably overestimated humpback whale population size by about 5% to 15%. Hammond (1986) calculated that this method could overestimate baleen whale populations by up to 11% over a one year sampling period, 23% over two years and 37% over three years. Perkins *et al.* (1984) suggested that variations in fluking behavior between individuals might produce underestimation of 10% to 20% using the Petersen capture-recapture method, but Rice, Carlson, Chu, Dolphin and Whitehead (1987) concluded that the effect on population estimates was not significant since calculated biases were only between 0 and 4%.

(7) Future goals

The collaborative, long-term research described above has produced the most comprehensive model available for the geographic structure of a baleen whale population in an ocean basin, but significant data gaps still exist.

Additional photographs must be obtained from the eastern North Atlantic Ocean; our collection contains only 11 individuals, yet over 1,500 humpback whales were taken from that region during 1880–1980 (K.C. Balcomb, pers. comm.). The population in the eastern North Atlantic is currently thought to be low (Bannister, Mitchell, Balcomb, Brown and Martin, 1984), but no estimates are available. We do not know whether humpback whales breed in the eastern North Atlantic, for example at the Cape Verde Islands. Humpback whale songs were recorded there by Winn *et al.* (1975), and whaling records document that up to seven humpbacks were taken each season during 1853–1883 (Mitchell and Reeves 1983), but no fluke photographs are available.

Further studies of the Antillean breeding range need to investigate whether individual whales use all subregions at random or in succession, and whether individuals return regularly to specific portions of the breeding range. Additional work in the lower Antilles is particularly needed even though several recent expeditions failed to find many whales. More effort should be made to photograph flukes of the whales occasionally killed by whalers in St. Vincent or Bequia (Ward, 1987). Documentation of whale deaths is important for maintaining accuracy of the collection as well as for any other information that the photographs might possibly reveal.

Given the relatively large confidence intervals to be expected, capture-recapture studies must be continued for a long time in order to reveal population trends. Advances in computer-assisted photographic analysis (e.g. Mizroch, Beard and Lynde, 1990) will become increasingly important as the photographic collection grows.

ACKNOWLEDGEMENTS

The North Atlantic Humpback Whale Catalog has been funded by the Marine Mammal Commission (1976, 1977) and the Northeast Fishery Center, Woods Hole, Massachusetts, of the National Marine Fisheries Service (1980–1987, Contracts NA-81-FA-C-00027 and 40-EANF-700314. Private contributions to College of the Atlantic in support of whale research, and volunteer efforts of many students and colleagues have also made this collaborative project possible.

We particularly thank the following workers whose long-term research projects have resulted in the contribution of significant collections of photographs: Alex Aguilar (University of Barcelona, Spain); Kenneth C. Balcomb (Center for Whale Research, Friday Harbor, Washington); Peter Beamish (Ceta-Research, Trinity, Newfoundland); Bob Bowman (Maine Whale Watch, Northeast Harbor, Maine); Carole Carlson and Philip Clapham (Cetacean Research Program, Provincetown Center for Coastal Studies, Provincetown, Massachusetts); Steve Frohock (Atlantic Cetacean Research Center, Gloucester, Massachusetts); Carl Haycock (Brier Island Ocean Study, Westport, Nova Scotia); Scott Kraus (New England Aquarium, Boston, Massachusetts); Finn Larsen (Greenlands Fisheries and Environmental Research Institute, Copenhagen, Denmark); Jon Lien (Memorial University of Newfoundland, St. John's, Newfoundland); George Marler (Caribbean Wildlife Society Tortola, British Virgin Islands); Scott Marion (Seafarers Expeditions); Anthony Martin (Sea Mammal Research Unit, Cambridge, England); David Mattila and Charles 'Stormy' Mayo (Cetacean Research Program, Provincetown Center for Coastal Studies); Gale McCullough; Scott Mercer (New England Whalewatch, Newburyport, Massachusetts); George Nichols, Jr. (Ocean Research Education Society, Inc., Gloucester, Massachusetts); Roger Payne (Long Term Research Institute, Lincoln, Massachusetts); Judith Perkins; Richard Sears, Fred Wenzel and Michael J. Williamson (Mingan Island Cetacean Society, Sept Iles, P.Q.); Johann Sigurjónsson (Marine Research Institute, Reykjavík, Iceland); Peter Stevick; Gregory S. Stone (College of the Atlantic); Edward B. Tucker (Kings Point, Somerset, Bermuda); William A. Watkins, William E. Schevill and Karen Moore (Woods Hole Oceanographic Institution); Mason Weinrich (Cetacean Research Unit, Gloucester, Massachusetts); Hal Whitehead (Dalhousie University, Halifax, N.S.); and Howard Winn (University of Rhode Island, Narragansett, R.I.).

We thank the following people who have helped with the technical aspects of assembling the existing catalog of humpback whale fluke photographs. For skillful darkroom work we thank Lisa Carpenter, Michelle Frentrop, Bill McDowell, Stephen V. Mullane and Peter Stevick. For patient and careful comparison of photographs we thank Lisa Baraff, Lydia Barnes, Harriet Corbett, Lauren

Gilson, Patty Harcourt, Cathy Iles, Suzanne Knecht, Scott Kraus, David Mattila, Rebecca May, Judith Perkins, Andrea Preston, Ann Rivers, Peter Stevick, Gregory S. Stone, Fred Wenzel and Virginia S. White. For assistance with data entry we are grateful to Matthew Hare, Melissa Hotchkiss, Charmaine Kinton and Ann Seymour. We thank Paul Cady, Harris Hyman and Alan Mainwaring for help with computer programming and database management; Philip Hammond (Sea Mammal Research Unit, Cambridge, England) for consultation in capture-recapture analysis; and John O. Anderson (College of the Atlantic) and Robert Collins (The Jackson Laboratory, Bar Harbor, Maine) for statistical advice.

We are grateful to Mr Edward McC. Blair, Bob Bowman, Mrs Francis Coleman, Mr and Mrs Henry B. Guthrie, Mr and Mrs Adrian Hooper, Mrs M.S. Ingalls, Mrs Seward Johnson, Mr C. Casard Kaesemeyer, Mr and Mrs Erasmus Kloman, Mr and Mrs Michael Kramer, Mr Tudor Leland, Mr and Mrs John Longmaid, Scott Mercer, Mr and Mrs Gerrish Milliken, Mr and Mrs Francis W. Peabody, Mr and Mrs Donald B. Straus, Mr and Mrs W.B. Dixon Stroud, Mr and Mrs Edward B. Tucker and Mrs Jephtha Wade for financial or logistic support important to the success of this project.

Finally, we thank Douglas Beach, Jeff Breiwick, Greg Donovan, Philip Hammond, Robert Hofman, Thomas Polacheck, Sally Mizroch, Gordon Waring and one anonymous reviewer for critical readings of this manuscript.

REFERENCES

- Baker, C.S. and Herman, L.M. 1987. Alternative population estimates of humpback whales (*Megaptera novaeangliae*) in Hawaiian waters. *Can. J. Zool.* 65:2,818-21.
- Baker, C.S., Herman, L.M., Perry, A., Lawton, W.S., Straley, J.M., Wolman, A.A., Winn, H.E., Hall, J., Kaufman, G., Reinke, J. and Ostman, J. 1986. The migratory movement and population structure of humpback whales (*Megaptera novaeangliae*) in the central and eastern North Pacific. *Mar. Ecol. - Prog. Ser.* 31:105-19.
- Balcomb, K.C. III and Nichols, G., Jr. 1978. Western north Atlantic humpback whales. *Rep. int. Whal. Commn* 28:159-64.
- Balcomb, K.C. III and Nichols, G., Jr. 1982. Humpback whale censuses in the West Indies. *Rep. int. Whal. Commn* 32:401-6.
- Balcomb, K.C. III, Katona, S.K. and Hammond, P.S. 1986. Population estimates for the North Atlantic humpback whale using capture-recapture methods on photo-identified whales. *Rep. int. Whal. Commn* 36: 110.
- Bannister, J.L., Mitchell, E.D., Balcomb, K.C., Brown, S.G. and Martin, A.R. 1984. Report of the subgroup on North Atlantic humpback boundaries. *Rep. int. Whal. Commn* 34:181.
- Begon, M. 1979. *Investigating Animal Abundance: capture-recapture for biologists*. University Park Press, Baltimore. 97pp.
- Carlson, C.A., Mayo, C.A. and Whitehead, H., 1990. Changes in the ventral fluke pattern of the humpback whale, *Megaptera novaeangliae*, and its effect on matching. Paper SC/A88/ID35 (published in this volume).
- CeTAP. 1982. Characterization of marine mammals and turtles in the mid- and north-Atlantic areas of the US outer continental shelf. NTIS PB83-215855. Springfield, VA 22161. 540pp.
- Chittleborough, R.G. 1965. Dynamics of two populations of humpback whale, *Megaptera novaeangliae* (Borowski). *Aust. J. Mar. Freshwater Res.* 16: 33-128
- Clapham, P.J. and Mayo, C.A. 1987. The attainment of sexual maturity in two female humpback whales. *Mar. Mamm. Sci.* 3(3): 279-82.
- Darling, J.D. and Morowitz, H. 1986. Census of 'Hawaiian' humpback whales (*Megaptera novaeangliae*) by individual identification. *Can. J. Zool.* 64:105-11.
- Darling, J.D., Gibson, K.M. and Silber, G.K. 1983. Observations on the abundance and behavior of humpback whales (*Megaptera novaeangliae*) off West Maui, Hawaii, 1977-1979, pp.201-22. In: R. Payne (ed.), *Communication and Behavior of Whales*. Westview Press, Boulder, Colorado. 643pp.
- Hammond, P.S. 1986. Estimating the size of naturally marked whale populations using capture-recapture techniques. *Rep. int. Whal. Commn* (special issue 8):253-82.
- Hammond, P.S. 1989. Heterogeneity in the Gulf of Maine? Estimating population size from individual recapture data when capture probabilities are not equal. Paper SC/A88/ID4 (published in this volume).
- Katona, S.K. 1986. Biogeography of the humpback whale, *Megaptera novaeangliae*, in the North Atlantic. pp. 166-71. In: A.C. Pierrot-Bults, S. van der Spoel, B.J. Zahuranec and R.K. Johnson (eds.) *Pelagic Biogeography*. Unesco Technical Papers in Marine Science 49, Paris. 295pp.
- Katona, S.K., Baxter, B., Brazier, O., Kraus, S., Perkins, J. and Whitehead, H. 1979. Identification of humpback whales by fluke photographs. pp.33-44. In: Winn, H.E. and Olla, B. (eds.) *The Behavior of Marine Mammals*, Vol. 3. Plenum Press, New York and London. 438pp.
- Katona, S.K., Harcourt, P., Perkins, J. and Kraus, S. (eds.) 1980. *Humpback Whales: A Catalogue of Individuals Identified in the Western North Atlantic Ocean by Means of Fluke Photographs*. 2nd ed. College of the Atlantic, Bar Harbor, ME 04609.
- Katona, S.K. and Kraus, S. 1979. Photographic identification of individual humpback whales (*Megaptera novaeangliae*): evaluation and analysis of the technique. US Department of Commerce, NTIS Publication PB-298-740, Springfield, VA, 30 29 pp.
- Katona, S.K. and Whitehead, H. 1981. Identifying humpback whales using their natural markings. *Polar Record* 20:439-44.
- Kaufman, G.D., Smultea, M.A. and Forestell, P. 1987. Use of lateral body pigmentation patterns for photo ID of east Australian (Area V) humpback whales. *Cetus* 7(1):5-13.
- Kraus, S. and Katona, S.K. (eds.) 1977. *Humpback Whales (Megaptera novaeangliae) in the Western North Atlantic: A Catalogue of Identified Individuals*. College of the Atlantic, Bar Harbor, ME 04609.
- Martin, A.R., Katona, S.K., Mattila, D., Hembree, D. and Waters, T.D. 1984. Migration of humpback whales between the Caribbean and Iceland. *J. Mammal.* 65:330-3.
- Mattila, D.K. and Clapham, P.J. 1989. Humpback whales, *Megaptera novaeangliae*, and other cetaceans on the Virgin Bank and in the northern Leeward Islands, 1985 and 1986. *Can. J. Zool.* 67(9): 2,201-211.
- Mattila, D.K., Clapham, P.J., Katona, S.K. and Stone, G.S. 1989. Population composition of humpback whales, *Megaptera novaeangliae*, on Silver Bank, 1984. *Can. J. Zool.* 67:281-5.
- Mitchell, E. 1973. Draft report on humpback whales taken under special scientific permit, eastern Canadian land stations, 1969-1971. *Rep. int. Whal. Commn* 23:138-54.
- Mitchell, E. 1974. Present status of northwest Atlantic fin and other whale stocks. pp.108-69. In: W.E. Schevill (ed.) *The Whale Problem: a status report* Harvard Univ. Press, Cambridge, Massachusetts. 419pp.
- Mitchell, E. and Reeves, R.R. 1983. Catch history, abundance and present status of northwest Atlantic humpback whales. *Rep. int. Whal. Commn* (special issue 5): 153-212.
- Mizroch, S.A., Beard, J.A. and Lynde, M. 1990. Computer assisted photo-identification of humpback whales. (Published in this volume).
- Payne, R. and Guinee, L.N. 1983. Humpback whale (*Megaptera novaeangliae*) songs as an indicator of 'stocks'. pp.333-53. In: R. Payne (ed.) *Communication and Behavior of Whales* AAAS Selected Symposium 76, Westview Press, Boulder, Colorado. 643pp.
- Perkins, J. and Whitehead, H. 1977. Observations on three species of baleen whales off northern Newfoundland and adjacent waters. *J. Fish. Res. Bd Can.* 34:1,436-40.
- Perkins, J.S., Balcomb, K.C. III, Nichols, G. Jr. and Deavilla, M. 1984. Abundance and distribution of humpback whales (*Megaptera novaeangliae*) in West Greenland waters. *Can. J. Fish. Aquat. Sci.* 41:533-6.
- Perkins, J.S., Bryant, P., Nichols, G. and Patten, D. 1982. Humpback whales (*Megaptera novaeangliae*) off the west coast of Greenland. *Can. J. Zool.* 60:2,921-30.

- Price, W.S. 1985. Whaling in the Caribbean: historical perspective and update. *Rep. int. Whal. Commn* 35:413-20.
- Rice, M., Carlson, C., Chu, K., Dolphin, W. and Whitehead, H. 1987. Are humpback whale population estimates being biased by sexual differences in fluking behavior? *Rep. int. Whal. Commn* 37:333-5.
- Scott, G.P. and Winn, H.E. 1980. Comparative evaluation of aerial and shipboard sampling techniques for estimating the abundance of humpback whales (*Megaptera novaeangliae*). US Department of Commerce, NTIS, Publication PB81-109852, Springfield, VA. 96pp.
- Sergeant, D.E. 1966. Populations of large whale species in the western North Atlantic with special reference to the fin whale. *Fish. Res. Board Can. Arctic Biol. Sta. Circ.* 9. 30pp.
- Seber, G.A.F. 1982. *The Estimation of Animal Abundance*, 2nd ed. Griffin and Co., London. 654pp.
- Sigurjónsson, J. and Gunnlaugsson, T. 1990. Recent trends in abundance of blue (*Balaenoptera musculus*) and humpback whales (*Megaptera novaeangliae*) off west and southwest Iceland based on systematic sightings records with a note on the occurrence of other cetacean species. *Rep. int. Whal. Commn* 40:537-51.
- Sokal, R.R. and Rohlf, F.J. 1981. *Biometry*, 2nd ed. W.H. Freeman and Co., San Francisco. 859pp.
- Stone, G.S. and Hamner, W.M. 1988. Humpback whales *Megaptera novaeangliae* and southern right whales *Eubalaena australis* in Guerlache Strait, Antarctica. *Polar Record* 24(148):15-20.
- Stone, G.S., Katona, S.K. and Tucker, E.B. 1987. History, migration and present status of humpback whales *Megaptera novaeangliae* at Bermuda. *Biol. Conserv.* 42: 133-45.
- Tyack, P. and Whitehead, H. 1983. Male competition in large groups of wintering humpback whales. *Behavior* 83:132-54.
- Ward, N. 1987. The whalers of Bequia. *Oceanus* 30(4):89-93.
- Weinrich, M. 1984. The humpback whales of Stellwagen Bank revisited. *Whalewatcher* 8(3):7-9.
- Whitehead, H.P. 1982. Populations of humpback whales in the northwest Atlantic. *Rep. int. Whal. Commn* 32:345-53.
- Whitehead, H., Chu, K., Harcourt, P. and Alling, A. 1982a. The humpback whales off west Greenland: summer 1981, with notes on other marine mammals and seabirds sighted. NTIS PB82-243924. Springfield, VA 22161. 25pp.
- Whitehead, H., Harcourt, P., Ingham, K. and Clark, H. 1980. The migration of humpback whales past the Bay de Verde Peninsula, Newfoundland, during June and July, 1978. *Can. J. Zool.* 58: 687-92.
- Whitehead, H., Silver, R. and Harcourt, P. 1982b. The migration of humpback whales along the northeastern coast of Newfoundland. *Can. J. Zool.* 60: 2,173-79.
- Williamson, G.R. 1961. Winter sighting of a humpback whale suckling its calf on the Grand Bank of Newfoundland. *Norsk. Hvalfangsttid.* 50: 335-6, 339-41.
- Williamson, M. 1984. Humpback whale research in the Gulf of St Lawrence. *Whalewatcher* 19(3):9-11.
- Winn, H.E., Edel, R.K. and Taruski, A.G. 1975. Population estimate of the humpback whale *Megaptera novaeangliae* in the West Indies by visual and acoustic techniques. *J. Fish. Res. Bd Can.* 32:499-506.
- Winn, H.E., Thompson, T.J., Cummings, W.C., Hain, J., Hudnall, J., Hays, H. and Steiner, W.W. 1981. Song of the humpback whale - population comparisons. *Behav. Ecol. Sociobiol.* 8:41-6.
- Zar, J.H. 1984. *Biostatistical Analysis*, 2nd ed. Prentice-Hall, Inc., Englewood Cliffs, NJ. 718pp.

Population Characteristics of Individually Identified Humpback Whales in the Central and Eastern North Pacific: A Summary and Critique

Anjanette Perry*, C. Scott Baker*

Laboratory of Genetics, National Cancer Institute-Frederick Cancer Research Facility, Building 560, Room 21-105, Frederick, Maryland 21701-1013, USA

and

Louis M. Herman

Kewalo Basin Marine Mammal Laboratory, University of Hawaii, 1129 Ala Moana Boulevard, Honolulu, Hawaii 96814, USA

ABSTRACT

Methods developed to obtain and record photographs of tail flukes and accompanying sighting data for humpback whales are described. Published descriptions of the migratory movement, abundance, reproductive histories and social organization of individually identified humpback whales based on our long-term studies in Hawaii and southeastern Alaska and other studies in the eastern and central North Pacific are reviewed. Biases and limitations associated with the collection and analysis of photographic data are discussed and additional methods that can be useful in describing population parameters for humpback whales and other cetacean species are suggested.

Humpback whales in the North Pacific, like those in the North Atlantic, appear to form geographically isolated feeding herds which intermingle on one or more wintering grounds. Mark-recapture analyses of resighting data suggest a seasonal population of 327 to 421 in the southeastern Alaska feeding region, and 1,113 to 1,701 on the Hawaiian wintering grounds. In Hawaii, multiple sightings of 18 sexually mature females provided an estimated calving rate (calves/female/year) of 0.58, but this value may be inflated by sighting biases. In southeastern Alaska, multiple sightings of 41 mature females provided an estimated calving rate of 0.37, which we believe is a better estimate of current reproductive rates. On the Hawaiian wintering ground, social organization can be described as a polygynous mating system involving male-male competition for mature females. In southeastern Alaska, the foraging strategies of humpback whales appear to be noncompetitive and, on occasion, cooperative.

INTRODUCTION

Biologists have long noted the remarkable variation in pattern and coloration of humpback whales (e.g. Lillie, 1915; Mathews, 1937). Schevill and Backus (1960), however, were the first to describe the use of these [idiosyncratic] markings to discriminate free-ranging individual humpback whales:

'Megaptera novaeangliae is a species in which minor individual variations are often sufficiently conspicuous and distinctive to enable even a shipboard observer to recognize individual whales out of small groups. Of the four Megaptera that we saw...our subject was readily distinguishable by its larger size, by the shape of the dorsal fin or hump (especially variable in this species) and by the distinctive color pattern of the underside of the flukes...'(p.279).'

The use of tail fluke color patterns and dorsal fin shapes to identify individual humpback whales was fully developed for field use primarily through the work of two independent programs of research – that of Charles Jurasz and his associates in southeastern Alaska (e.g. Jurasz and Palmer, 1981) and Steve Katona and his associates in the North Atlantic (e.g. Katona, Baxter, Brazier, Kraus, Perkins and Whitehead, 1979). Although dorsal fins can vary considerably, the most distinctive anatomical features are the markings, scarring and patterns of white and black coloration on the underside of the flukes. Coloration among individual whales ranges through a variety of patterns, from all black, to mottled, to nearly pure white. Some change in the degree of pigmentation in young

animals has been noted (Jurasz and Palmer, 1981; Carlson, Mayo and Whitehead, 1990), but color patterns appear to stabilize by about three years of age and the shape of each fluke's trailing edge seems fixed from birth. Adult individuals resighted across intervals as long as 16 years (Baker, Perry and Vequist, 1988) in the North Pacific have shown little alteration in the characteristic markings or coloration of their flukes.

Here we describe methods developed to obtain and record photographs of flukes and accompanying sighting data for humpback whales in the central and eastern North Pacific. We also review the published results of our study that are pertinent to an understanding of humpback whale population parameters. Finally, we discuss biases and limitations associated with the collection and analysis of photographic data, and suggest additional methods that can be useful in describing population parameters for humpback whales and other cetacean species.

METHODS

The majority of research findings summarized in this paper were obtained from studies conducted in Hawaii and southeastern Alaska by personnel from the Kewalo Basin Marine Mammal Laboratory (KBMML) and by one of us (CSB) during doctoral and contracted research projects. Collaboration with other independent researchers (listed in Acknowledgements) increased the data base to include sighting records from additional feeding and breeding areas. A photographic catalog of 1,140 individually identified whales assembled from the combined efforts of

* Present address: Dept Biological Sciences, Victoria University of Wellington, Wellington, New Zealand.

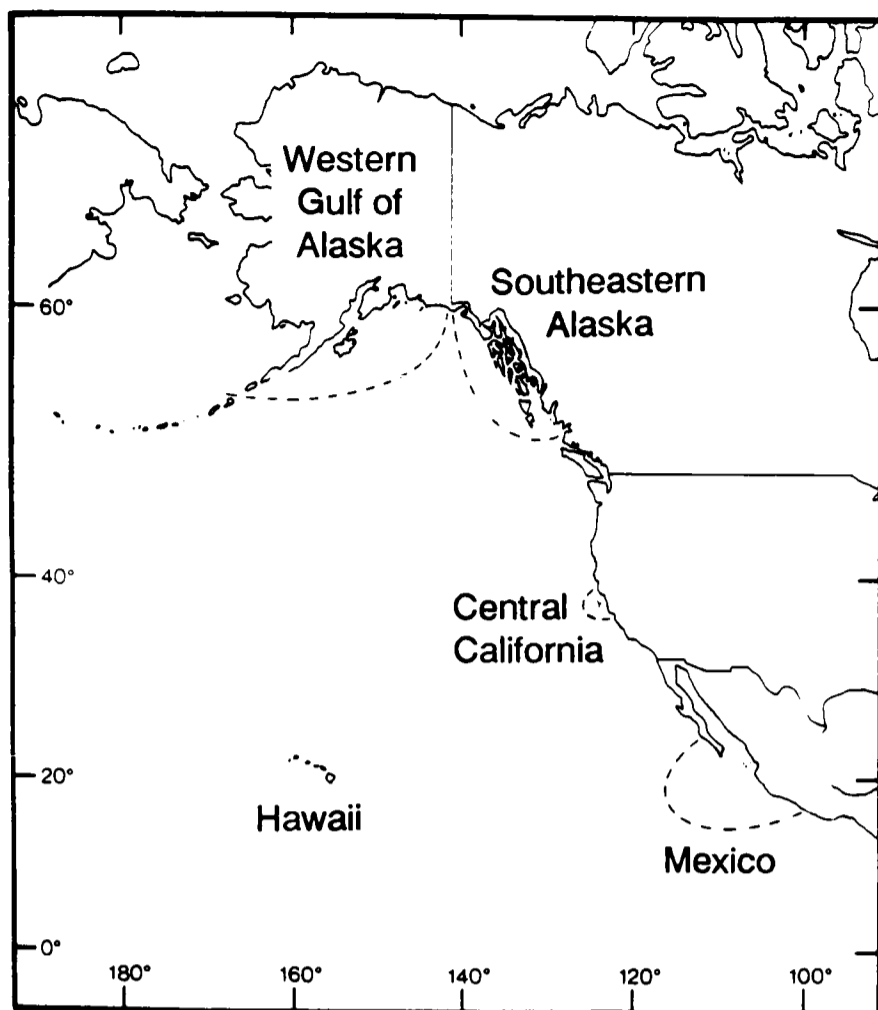

Fig. 1. Major study regions of the central and eastern North Pacific.

these research programs provides one of the most complete records of sightings of humpback whales in the North Pacific (Perry, Mobley, Baker and Herman, 1988).

Study locations and periods

Research effort was concentrated in five regions of the central and eastern North Pacific (Fig. 1). Two of these regions are winter habitats or breeding grounds: (1) the main Hawaiian Islands and (2) the west coast of Mexico. Three of the regions are primarily summer habitats or feeding grounds: (1) the coast of central California; (2) southeastern Alaska; and (3) the western Gulf of Alaska.

Photographs were collected in Hawaii during all winters from 1977–85 and in southeastern Alaska during all summers from 1979–85. They were collected from the other study regions at various times during the period 1977–85 (Table 1).

Table 1

Years humpback whales were photographed in each region.

Region	Years studied
Hawaii	1977-85
Southeastern Alaska	1979-85
Western Gulf of Alaska	1977, 1980, 1982-5
Mexico	1978, 1980, 1985
California	1979-81, 1983, 1985

Photography

Photographs of the ventral surfaces of the tail flukes were taken with 35mm cameras equipped with telephoto lenses and motor drives or power winders. Photographs were usually taken from small boats that were quick and manoeuvrable, but at times were taken from larger research vessels. A variety of films were used, but we have

found high-speed black and white negative film (*Kodak Tri-X* or similar) to be the most suitable. This film has several advantages: (1) it can be used under a broad range of light conditions in the field, including under very low dusk or winter light if 'pushed' to 1600 ASA; (2) selected frames can be printed and stored separately from the negatives; (3) processing is simple and inexpensive; and (4) repeated use of the prints does not degrade the original negative.

Photographic comparisons

Photographs from each observation of a whale or pod of whales were examined and the best photograph of each individual was printed. We found that printing negatives so that image size of all flukes was similar (2–3" from tip to tip of the flukes for a 3x5" print) greatly enhanced our ability to make matches, as did printing all photographs in black and white. Each print was then assigned a unique 'Observation' number. If that photograph was later matched with another taken during a different observation period (i.e. pod composition, sighting date, and/or location differed), both photographs were assigned an 'Animal' number which was used for all subsequent sightings of that individual whale. The record of each Observation included sighting date, location, behavioral role of the whale and pod size (Table 2). This information, stored on computer in a Statistical Analysis Systems (SAS) data file, forms a 'library' of sighting histories that was used in virtually all the research analyses described here.

Table 2

Examples of the primary variables stored with each 'Observation' record in the SAS database. Obs= observation and Ani= Animal.

Number				Pod			Photo quality
Obs	Ani	Region	Date	No.	Size	Rôle	
0101	022	HI	02.02.80	4	4	none	good
0104	-	HI	02.02.80	4	4	none	poor
0388	-	HI	19.02.81	5	3	cow	good
0398	022	HI	19.02.81	5	3	escort	good
1149	045	HI	20.03.81	1	1	singer	good
0727	599	SEA	03.07.81	2	1	none	good
0728	022	SEA	03.07.81	3	2	none	poor

All photographs were judged to be of either good, poor, or insufficient quality. Good photographs showed at least 50% of both left and right flukes at an angle sufficiently vertical to distinguish the shape of their trailing edges. Poor quality photographs showed at least some distinctive feature of the flukes, but lacked clarity or showed too little area. For example, a poor quality photograph might show the left fluke but not the right. Such a photograph could be matched to a good quality picture, but not to another poor quality print showing only the right fluke of the same whale. Insufficient quality photographs did not show enough information to make an unambiguous match to another photograph, and were deleted from the data set.

Within each major study region, individual photographs were organized according to decreasing amount of white pigmentation on the flukes. Additionally, whales with similar scarring and color patterns were grouped together. Thus, any new photograph could be initially compared to a smaller subset of the entire collection to establish a resighting. Each one was examined against the entire data

set on at least three occasions, with several researchers participating in the comparison process. Subsets of photographs taken within a particular region or year were typically compared to each other ten or more times.

Matching errors

In making our photographic comparisons, we assumed that each photograph identified a unique individual until demonstrated to be otherwise. Using this as our null hypothesis, two types of errors could be made when comparing pairs of photographs. If two photographs were considered to be a match when in fact they were of different whales, i.e. our null hypothesis was rejected when in fact it was true, a 'misidentification' error resulted. In a given sample of photographs, misidentification would lead to an undercounting of the number of unique individuals. Similarly, if the null hypothesis was accepted when in fact it was false, a 'nonidentification' error resulted, leading to an overcounting of the unique individuals in a photographic sample. We were very stringent in the requirements for a match and feel it is improbable that two different whales were considered to be the same individual. By choosing to reduce our misidentifications, however, we increased the chances of nonidentifications. To help counter this bias and thus reduce both types of errors, we used only good quality photographs for population analyses. If any pair-wise comparison of photographs resulted in a quandary, one or both of the photographs were downgraded to poor or insufficient quality.

RESULTS

Migratory movement and population structure

The details of migratory movement and stock segregation of humpback whales in the North Pacific are still not fully understood. Using the observations of early whalers, Kellogg (1929) suggested that humpback whales in the North Pacific were divided into American and Asian stocks. He proposed that the Asian stock winters in tropical waters south of Japan and travels north to feeding areas in the Sea of Okhotsk and along the Kamchatka Peninsula. The American stock was thought to breed in the waters off the west coast of Mexico and travel northward along the coast of North America to feeding grounds in the Gulf of Alaska, the Bering Sea and near the Aleutian Islands. Although Rice (1978) suggested that whales from the Hawaiian wintering grounds are part of an extended American stock, Kellogg (1929) did not consider this group and may have been unaware of its existence (Herman, 1979).

To examine patterns of migratory movement in humpback whales of the central and eastern North Pacific, we assembled identification photographs of more than 1,000 individual whales (Baker, Herman, Perry, Lawton, Straley, Wolman, Kaufman, Winn, Hall, Reinke and Ostman, 1986; Perry *et al.*, 1988). The collection included photographs from five geographically isolated regions: (1) the main Hawaiian Islands; (2) the west coast of Mexico, including the Islas Tres Marias and the Islas de Revillagigedo; (3) the coast of central California, including the Farallon Islands; (4) southeastern Alaska, including Yakutat Bay; and (5) the western Gulf of Alaska, including Prince William Sound.

A comparison of photographs among the three feeding regions and between the two wintering grounds revealed little movement within seasonal habitats, i.e. between

Table 3
Humpback whale resightings across regions
(see also note added in proof on p.317)

Sighting region	Resighting region				
	HI	MEX	SEA	WGA	
Hawaii [HI]	634	2	82	17	1
Mexico [MEX]	-	36	1	1	1
Southeastern Alaska [SEA]	-	-	464	2	0
Western Gulf of Alaska [WGA]	-	-	-	95	0
California [CA]	-	-	-	-	18
Total sightings					1,247
Total individuals (Total whales minus resights across regions)					1,140

wintering grounds or among feeding regions (Baker *et al.*, 1986; Perry *et al.*, 1988; Table 3). Across all study years, only two whales were sighted on both the Hawaiian and Mexican wintering grounds and only two whales were sighted in both the western Gulf of Alaska and the southeastern Alaska feeding regions. No movement was found between the feeding regions of southeastern Alaska and central California or between the western Gulf of Alaska and central California.

Baker *et al.* (1986) used an estimate of across-years-within-region resighting probability from southeastern Alaska to conclude that the observed movement across feeding regions was far less than expected from chance if individuals randomly assorted among these regions in different years. Strong fidelity to a given feeding region was also indicated by the large proportion of migratory returns to some regions (Table 4). Of the 464 whales sighted in southeastern Alaska between 1979 and 1985, 225 (48%) were sighted in more than one year (Perry *et al.*, 1988). Site fidelity, as demonstrated by photographic resighting, was also reported for whales in Prince William Sound and other areas of the western Gulf of Alaska (Hall, 1979; Matkin and Matkin, 1981; Rice and Wolman, 1982; von Zeigesar and Matkin, 1986).

Baker *et al.* (1986) repeated their analysis of across-years-within-region resighting probability for the Hawaiian wintering ground and concluded that movement between the two wintering grounds was also less than expected from chance if random assortment occurred in alternate years. Strong fidelity to a given wintering ground, however, was less obvious than on the feeding grounds. Of the 634

Table 4
Humpback whale resightings across years within each regional habitat.

Regional habitat	Number of years sighted					Total
	1	2	3	4	>4	
Hawaii	511 81%	89 14%	22 3%	9 1%	3 0.4%	634
Mexico	36 100%	-	-	-	-	36
Southeastern Alaska	239 52%	76 16%	58 12%	40 9%	51 11%	464
Western Gulf of Alaska	75 79%	18 19%	2 2%	-	-	95
California	18 100%	-	-	-	-	18

whales sighted in Hawaii between 1977 and 1985, only 19% were sighted in more than one year (Perry *et al.*, 1988). Because the proportion of resightings across years is a function of both sample size and true abundance, it is difficult to assess fidelity of migratory return to Hawaii without further information from the other wintering ground. Across-years resightings from the Mexican grounds have been documented by Alvarez, Aguayo, Rueda and Urban (1990).

In contrast to the movement between grounds in the same season, migratory movement between feeding and breeding grounds was extensive (Baker *et al.*, 1986; Perry *et al.*, 1988) (Table 3). Whales from both the Hawaiian and Mexican wintering grounds travelled to all three feeding regions, although not in equivalent proportions. The strongest migratory connections observed were between Hawaii and the two Alaskan feeding grounds: 18% of the animals sighted in southeastern Alaska (82 of 464 individuals) and 18% from the western Gulf of Alaska (17 of 95) were also sighted in Hawaii. The number of photographs from Mexico and central California in our library was too small to draw any conclusions about the strength of migratory connections to these regions.

Recent work in the eastern North Pacific, however, suggests that humpback whales are more likely to move between California and coastal Mexico than to more distant feeding and breeding grounds. Dohl, Guess, Duman and Helm (1983) used seasonal trends in aerial sightings to suggest that central California was the north terminus for some humpback whales. Calambokidis, Cabbage, Steiger, Balcomb and Bloedel (1988), in collaboration with Mexican researchers Jorge Urban and Carlos Alvarez, reported 18 matches between humpback whales photographed off central California and those photographed near the coast of Mexico, far more than the single match reported by Baker *et al.* (1986). The movement of some whales from Mexican waters may be even more restricted. Urban and Aguayo (1987) reported that a small number of humpback whales use the northern Gulf of California as a summer feeding ground. It is not known whether these animals remain in the Gulf during the winter season, move to other regions within Mexican waters, or possibly migrate south to undescribed wintering grounds along the coast of Central and South America.

Photographic comparisons indicate that humpback whales in the eastern and central North Pacific do not form two completely isolated subpopulations with separate feeding grounds that correspond to the Hawaiian and Mexican wintering grounds. Neither are they entirely nomadic, assorting randomly among different regions of each seasonal habitat in alternate years. Instead, the analysis of regional fidelity and migratory movement indicates that these whales, like humpback whales in the North Atlantic (Katona and Beard, 1990), form several geographically isolated 'feeding herds' during summer months. Individuals from the southeastern Alaska and western Gulf of Alaska feeding herds intermingle on the Hawaiian wintering grounds. Currently available data indicate some degree of isolation between the California and Alaska herds, but both Hawaii and Mexico are visited by at least a few individuals from each group during the breeding season. Movement of individual whales between these two wintering grounds seems to be relatively infrequent, although it does occur. In most cases, the segregation or intermingling of whales from different regions is not absolute, but a matter of degree.

The complex pattern of humpback whale movements reveals the inadequacy of viewing these whales as a unified 'stock.' By definition, all individuals within a given stock should have the potential to freely intermingle during both summer and winter (Chapman, 1974). Baker *et al.* (1986) suggested instead that humpback whale groups in the North Pacific are best described as 'structured stocks.' Each structured stock consists of several feeding herds which may intermingle to breed on one or more wintering grounds. Within a structured stock, sets of whales associate with different probabilities in each seasonal habitat. These seasonal changes in probabilities of associations have important implications for understanding the social organization of humpback whales and for evaluating management programs for this species.

Abundance

The North Pacific population of humpback whales is thought to have numbered between 15,000 and 20,000 individuals prior to intensive exploitation by the commercial whaling industry (Rice, 1978). At the time of its international protection in 1967, this population may have been reduced to no more than 1,000 animals. To what extent it has recovered over the last 20 years is a controversial question at present.

Our direct counts of identified individuals would suggest a minimum estimate of 1,140 humpback whales in the North Pacific. This count, however, is based on photographs collected across a 10 year period. During this period, the number of births and deaths could render the count nearly meaningless as a current estimate of abundance. Based on this count alone, it is correct to assume only that at least 1,140 individual humpbacks have lived in the last ten years.

Mark-recapture analyses are more likely to provide reasonable estimates of abundance and population trends in regions where across-years sighting information is available. For such an analysis, an animal is considered 'marked' or 'captured' when it is photographically identified. Any subsequent resightings of that individual are considered to be a 'recapture'. Based on resightings of 291 individual whales across five summer seasons in southeastern Alaska, Baker *et al.* (1986) derived the weighted mean of the Petersen estimate (Begon, 1979) to suggest a seasonal population of 374 (95% confidence interval, 327 to 421) individuals in southeastern Alaska. They noted, however, that the weighted Petersen should be an inflated estimate of current abundance since it does not correct for births and deaths during the study years. More recent photo-identification surveys of southeastern Alaska indicate that this population is stable or possibly growing (Baker, Straley and Perry, 1988).

Mark-recapture estimates of abundance are currently available from two other feeding regions in the North Pacific. In Prince William Sound, von Zeigesar and Matkin (1986) identified 96 individuals across the years 1977-84. Using the Schnabel formula, they estimated a local population of about 100 individuals. They noted, however, that across-years resighting frequencies suggest that their Prince William Sound study area does not encompass the full seasonal range of the 'southcentral Alaska' (equivalent to our western Gulf of Alaska) herd and thus may underestimate the regional population. Off the coast of central California, Calambokidis *et al.* (1988) identified a total of 177 individuals during the summer and fall seasons

of 1986 and 1987. Using between-year resighting data, they estimated a population of 230 (95% confidence interval, 200 to 260) for this feeding region.

For the Hawaiian wintering grounds, Darling, Gibson and Silber (1983) used the Petersen formula to estimate a population of 895 (95% confidence interval, 592 to 1,837) based on resighting data from the years 1978–9. They expressed little confidence in this estimate, however, and suggested that the necessary assumptions of the Petersen model were not met by their sample. More recently, Darling and Morowitz (1986) used three analyses based on photo-identification to ‘census’ the number of humpback whales visiting Hawaii during the years 1977–81: (1) the fit of the Bernoulli distribution to the observed sighting frequency of photo-identified whales within seasons; (2) a graphic interpretation of the rate of newly photo-identified whales within and across seasons; and (3) direct counts of photo-identified whales within and across seasons. The best estimates from these analyses were 1,000 whales in one winter season and 2,100 over five winter seasons, with a minimum count of 922 individuals photo-identified across the entire study period.

Baker and Herman (1987) cited problems with Darling and Morowitz’s (1986) mark-recapture model, including a poor fit of the Bernoulli distribution and potential biases in estimates based on the rate of newly photo-identified whales. Using data from their own study of photo-identified humpback whales in Hawaiian waters during 1980–3, Baker and Herman (1987) calculated several alternate estimates of across-years abundance. They concluded that the weighted Petersen was the most robust estimate, based on its narrow confidence limits and use of cumulative across-years data, and suggested that a total population of 1,407 animals (95% confidence limits, 1,113 to 1,701) visited the Hawaiian Island across their four-year study, including whales that were born or died during that time. They cautioned, however, that this estimate could be inflated by as much as 37% from births and deaths alone.

Reproductive histories of females

Historically, the reproductive biology of baleen whales has been described only from the examination of carcasses in commercial catches. Once a population is protected from harvest, comparable data on subsequent changes in reproductive parameters are difficult to collect. Only in a few protected populations, including the California gray whale (Rice and Wolman, 1971; Reilly, 1984) and the bowhead whale (Nerini, Braham, Marquette and Rugh, 1984), are recent censuses and records of aboriginal or scientific catches available for estimating current population parameters. Among populations of naturally marked animals, however, sighting records of individuals across years can be used to construct reproductive histories. From the reproductive histories of individually identified female humpback whales in the North Pacific, we have attempted to measure interbirth or calving intervals and to estimate average calving rates for this population (Baker, Perry and Herman, 1987).

Records of females sighted across more than a single year provided information on the calving intervals of individual whales. We defined a calving interval as the number of years separating seasons in which a female was accompanied by a calf. Most sighting records were not continuous, and we assumed that the female was accompanied by a calf in her unsighted year. As a

consequence of this assumption, intervals unbounded by a sighting were only a minimum estimate of the true calving interval.

Forty total sightings of 18 Hawaiian females across the years 1980–5 included 17 two-year calving intervals and 1 one-year interval. In southeastern Alaska, 138 sightings of 41 females across the same years included records of 65 calving intervals. One of these intervals was one year; 49 intervals were two years; 11 were three years; 2 were four years; 1 was five years; and 1 was thought to be seven years. Data for those females with the most complete sighting records are presented in Table 5.

Table 5

Reproductive histories of those female humpback whales with the most complete records of sightings in southeastern Alaska.

Animal number	Sighting year						
	80	81	82	83	84	85	86
573	C	A	-	A	C	A	C
161	A	A	A	C	A	A	C
539	A	A	C	A	A	C	A
587	A	A	A	A	C	A	C*
530	-	A	C	A	C	A	C
581	-	A	A	A	C	A	A
593	-	A	A	C	A	A	-

* The 1986 calf of animal number 587 disappeared during July of that summer and was presumed dead.

The unusually long reproductive intervals of some individuals reported here are not biased by sightings prior to attainment of sexual maturity. The previous work of Jurasz and Palmer (1981) provided additional information on the reproductive history of the females with the two longest calving intervals. Possible problems in confirming the seven year interval of animal number 166 are discussed in the Critique. Jurasz and Palmer (1981) reported that number 587, nicknamed ‘Gertrude’, was first sighted in 1973 and subsequently sighted with a calf in 1977. Thus, the five year calving interval extending from 1980 to 1984 is not the result of including sighting records prior to this animal’s sexual maturity. The death of a calf prior to any one of these summer sightings, as was observed for her in 1986 (Baker *et al.*, 1987), is a possible explanation for this unusually long calving interval.

If resighting histories of females were complete, their average calving rate would simply be the inverse of their average calving interval. Unfortunately, the number of sightings of females bounded by both their previous and subsequent sightings with a calf is currently too small for this calculation. We chose instead to estimate yearly calving rates by dividing the number of sightings of photo-identified females with calves by the total number of sightings of photo-identified females with or without calves. This estimate makes no assumption about the presence or absence of a calf during years when an individual was not sighted. It does assume, however, that the chances of sighting a female were not affected by the presence or absence of a calf (see Critique).

In Hawaii, the average calving rates of individual females varied from a low of 0.43 (calves/female/year) in 1980 to a high of 0.77 in 1983. Year to year differences were not significant and the combined calving rates provide an estimate of 0.58 (95% confidence interval, 0.41 to 0.75). In southeastern Alaska, the average calving rates also showed

considerable year to year variation, ranging from a low of 0.24 in 1985 to a high of 0.48 in 1984. Overall differences across the 1980–5 study were not statistically significant, however, and we combined all years to estimate an average calving rate of 0.37 (95% confidence interval, 0.28 to 0.46). The observations from southeast Alaska suggest that, on average, a mature female gives birth only once every 2.7 years to a calf that survives its first six months of life and its first migratory transit.

Social organization

Many early whalers assumed that pods of humpback whales represented stable family groups which remained together throughout the year. This assumption was based on the age and sex composition of a few pods in which all or most of the members were killed. Through our analysis of individual resighting histories, however, we have found that pod composition is dynamic and that the social organization of humpback whales is dramatically different in each seasonal habitat.

The social structure of humpback whales in Hawaii is extremely fluid and associations between individuals in a group are transient. The resighting histories of individuals in Fig. 2 give some idea of the complexity of these associations. Females are seen serially and simultaneously with multiple males and males are seen serially with a succession of females (Baker and Herman, 1984a). Frequent changes in pod composition appear to be the result of males aggressively excluding other males from the proximity of sexually mature females (Darling *et al.*, 1983; Tyack and Whitehead, 1983; Baker and Herman, 1984a; Mobley and Herman, 1985). In 33 extended observations collected over six years of study, Baker and Herman (1984a) documented only one pair of adults that remained together for more than a few hours. Escort No. 73 and cow No. 71, accompanied by her calf of the previous year, were

seen together on two consecutive days, apparently at a time when the cow was weaning her yearling. Assuming the cow and escort remained together between the two sightings, this association is one of the longest documented between adult whales in Hawaii and perhaps indicates the formation of a brief mating bond. These observations suggest that humpback whales are not monogamous and do not form stable pair bonds during the winter breeding season. Instead, the social organization of humpback whales in Hawaii can be described as a polygynous or promiscuous mating system involving male-male competition for sexually mature females.

On the southeastern Alaska feeding grounds we have been able to distinguish two distinct patterns of social associations correlated with foraging strategies: (1) fluid associations between whales feeding on swarming krill and (2) stable or repeated associations between individuals feeding on schooling fish (Baker and Herman, 1984b; Baker, 1985).

When feeding on swarms of krill, humpback whales sometimes form large aggregations referred to by early whalers as 'shoals' (Nemoto, 1964). Within these shoals, which may include as many as 80 whales within a few square kilometers, individuals casually join and leave smaller pods of four or fewer members. Although the transient membership of these feeding groups is similar to that of mating groups, their sexual composition and behavior differ markedly. Feeding groups may be composed of all males, all females, or both sexes, and little overt aggression or competition is observed (Baker, 1985).

Among whales feeding on schooling fish, pod stability may extend far beyond the casual level seen within shoals. On three occasions in 1981 and again on three occasions in 1984, we observed a pod of seven to eleven whales feeding together on schooling herring. The examination of individual identification photographs showed that

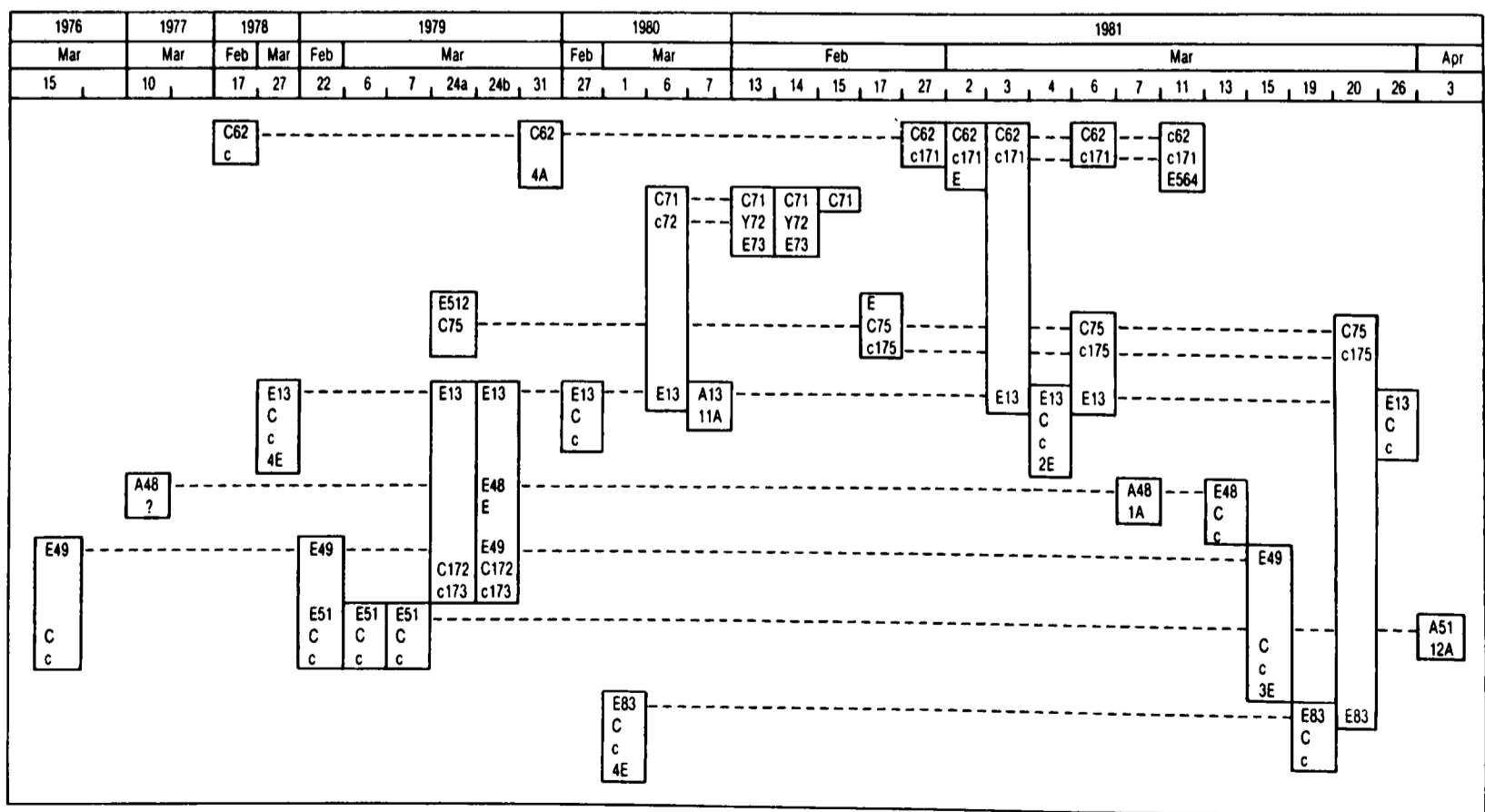

Fig. 2. The associations of cows and escorts in Hawaii. Letters indicate behavioral role or age class: A = adult; C = cow with calf or yearling; c = calf; E = escort; Y = yearling. Numbers preceding letters indicate several animals in a particular behavioral category; letters without numbers following indicate that the whale was not identified by a fluke photograph. Thus, 4E = 4 escorts not identified by photographs. Individually identified whales are designated by their whale number and behavioral role. Thus, C62 = cow no. 62; A62 = same individual unaccompanied by a calf in that sighting year. Resighted individuals are shown across rows connected by dashed lines. Boxes enclose pods, i.e. codes within a box designate whales sighted together.

1981		1982		1983		1984		1985			
Jul		Jul	Aug	Jul	Aug	Jul	Aug	Jun	Jul	Aug	Sept
A166	A166	A166	A166	A166	A166	A166	A166	A166	A166	A166	A577
A577	A577	A577	A577	A577	A577	A577	A577	A577	A577	A577	A577
A587	A587	A587	A587	A587	A587	A587	A587	A587	A587	A587	A587
A155	C155	C155						C155	C155	C155	C155
A573				A573	A573			c445	c445	c445	c445
						C573	C573	A573	A573	A573	A573
						c382		A236	A236	A236	A236
	A581			A581				A581	A581	A581	A581
						C581	C581				
						c353					

Fig. 3. The sighting records and associations of whales in a socially stable feeding pod in southeastern Alaska. See Fig. 2 for description of codes.

associations between some of the individuals in this pod extended across all six sightings in the three year period (Baker, 1985). Adult females seemed to predominate among the regular members of this pod, but males were also present.

We have more detailed observations of another socially stable and behaviorally coordinated pod of whales in southeastern Alaska across the years 1981 to 1985 (Fig. 3). This group was always sighted within a few kilometers of a submarine ridge located at the confluence of three straits. Hydroacoustic assessment and net tows in their vicinity showed that large schools of adult herring provide abundant prey (Krieger and Wing, 1984; 1986). The close association of these whales across a summer season was nearly continuous (Baker, 1985; Perry *et al.*, 1985; Baker, 1986). Annual membership in the group seemed to be influenced by sex and reproductive status. Six of the 'core' members of this group were known to be mature females and these females were less likely to join in years that they were accompanied by a calf. In 1984 the group did not form, although individual members remained in the area. Group formation may have been inhibited by the presence of calves with three of the core members.

Why is feeding on schooling fish associated with such closely coordinated behavior and long-term associations between individuals? It seems likely to us that these groups are more efficient than singles or pairs at herding agile and fast-swimming fish. Like the pack-hunting strategies of lions, wolves and killer whales, cooperative feeding may allow humpback whales to achieve greater success than they could as solitary feeders. Further observations of these individuals can help us to learn more about the interdependence of social behavior and foraging strategies of humpback whales.

CRITIQUE

Migratory movement and population structure

Ongoing studies of humpback whales in the North Pacific and North Atlantic have demonstrated the power of photo-identification in describing patterns of seasonal movement within oceanic populations. In the central and eastern North Pacific, at least occasional migratory movement between almost every known seasonal habitat has already been documented (Darling and Jurasz, 1983; Darling and McSweeney, 1983; Baker *et al.*, 1985; Baker *et al.*, 1986; Perry *et al.*, 1988). The task now remains to extend this description throughout the historic range of humpback whales in each ocean and to quantify the degree of exchange among subpopulation units. In the North Pacific, photographs are needed from the waters along the

Aleutian Islands and the Alaska Peninsula as well as from the Asian wintering grounds. Without a reasonable sample of photographs from these historically important habitats, our understanding of migratory movement will remain incomplete.

To quantify levels of exchange between subpopulation units, photographs should be collected systematically and concurrently across years from at least two putative feeding herds and two geographically isolated wintering grounds. The growing collections of photographs from the western Gulf of Alaska, southeastern Alaska, central California, Hawaii and Mexico are a promising start to such an analysis. An across-years and between-regions comparison of these photographs could provide a quantitative index of exchange or fidelity within and between seasonal habitats. With this index it should be possible to assess the relative extent and permanence of an individual's natal fidelity to wintering grounds or maternally directed fidelity to feeding regions.

Abundance

Photoidentification of humpback whales lends itself to estimates of population abundance by direct counts and by mark-recapture analyses. Direct counts or censuses of photo-identified individuals provide a minimum estimate of regional abundance if collected during a single season. An overestimate could occur only if failure to recognize a previously identified individual was common. In feeding regions where photographic effort is high and the seasonal residency of whales is protracted and relatively unbiased by age-sex class, direct counts may provide reasonably accurate estimates of abundance. On the wintering grounds where the number of animals is large and their seasonal residency is short and variable, counts collected during a single season are likely to underestimate abundance by a considerable margin. Cumulative counts of individuals collected across years are more difficult to interpret. Even in a closed population, across-year counts could overestimate abundance depending on the length of the census, the extent of the sampling effort and the rate of births and deaths in the population.

With long-term sighting histories, mark-recapture models are likely to provide the most satisfactory estimates of humpback whale populations if applied with consideration for the ecology and behavior of the species, and for the unique characteristics of photo-identification data. A general presentation of mark-recapture methods is found in Caughley (1977) and Seber (1982). Hammond (1986) presents an excellent review of the strengths and weaknesses of these models when applied to naturally marked whales. Here we will address only two assumptions of mark-recapture models that require special attention for application to populations of humpback whales: (1) all marks are permanent and are noted correctly on recapture and (2) all individuals have an equal chance of being caught during each sample, or the probability of capture is stratified by some known and identifiable characteristic of an individual (e.g. age or sex).

The identification or 'tagging' of individuals from photographs of natural markings presents some challenges to the assumption that all tags are permanent and noted correctly on recapture. Although the markings and shape of adult humpback whale flukes have been shown to remain stable over periods as long as 16 years, dramatic changes can occur due to injury and scarring. Available tests for tag loss should be applied to assess the frequency

of this occurrence. Among young animals, particularly calves, markings are often indistinct and coloration is subject to dramatic changes during the first two or three years of life (Carlson *et al.*, 1990). The exclusion of calves and juveniles from mark-recapture analyses can help correct for this bias.

As discussed in the Methods section, a photographic mark could be improperly noted in two ways: photographs of a single whale could be counted as different individuals or photographs of different whales could be counted as a single whale. We were very stringent in our requirements for a match and consider it improbable that two different whales were considered to be the same in our analyses. The near absence of discovered errors of this type in reviews of our catalog supports this belief. Nonidentification errors, on the other hand, were more common, and a few new matches were made each time the catalog was reviewed.

The probability of a nonidentification error is likely to increase as the number of photographs increases due to the sheer volume of comparisons, and ensuing visual fatigue or saturation. In a final review of our catalog, we laid out all of the prints and sorted them according to general similarity before comparing each to the remainder. With photographs of over 1,100 individual whales we felt that we were reaching the limit of effectively reviewing the catalog in its entirety. Although the development of computerized systems will aid in the matching of individual photographs to an established catalog, it seems unlikely that such systems will allow the rapid shuffling and simultaneous display of a large number of photographs, as has been our typical method for comparing new photographs or reviewing an existing catalog. Until powerful pattern recognition programs become commonly available, a potential tradeoff between large sample size and the number of missed matches may be inevitable in mark-recapture analyses of photo-identification data.

Several aspects of the ecology and behavior of humpback whales could affect the assumption of equal catchability: (1) individuals may migrate to a particular regional habitat in some years but not in others; (2) animals may arrive in a region during the sampling period in some years but not in others; (3) within a region, animals may have preferred ranges that are not uniformly sampled; and (4) there may be age or sex-specific differences in the frequency of dives where the tail flukes are extended (Rice, Carlson, Chu, Dolphin and Whitehead, 1987). Increasing the time and geographic extent of sampling effort within a region can help to minimize biases 2 and 3. Bias 4 could be minimized by picking pods according to a randomized schedule and remaining until a photograph of the flukes is collected from all individuals. Bias 1, however, is more difficult to evaluate and requires information about the probability of sighting an individual in more than one geographic region across years, i.e. seasonal population structure, and about the uniformity of migratory cycles.

Based on our current understanding of population structure in the North Pacific, there appear to be several reasons why mark-recapture estimates of abundance from individual feeding regions (i.e. southeastern Alaska, western Gulf of Alaska and possibly central California) are likely to be less biased by these behavioral attributes and thus more accurate than similar estimates from the Hawaiian wintering ground. First, there is considerable evidence that individuals maintain fidelity to a given feeding herd, thus approximating a 'closed' population within a given region. Each feeding herd is a smaller subset

of the larger winter aggregations, and equivalent effort can provide a more complete sample. Second, the seasonal residency of individuals on the feeding grounds is known to be lengthy (up to at least six months) and relatively unbiased by age-sex class. Third, age or sex-specific differences in the frequency of flukeup dives seem less pronounced (CSB, personal observation) and an identification photograph can usually be obtained if the researcher is persistent.

Fidelity to the Hawaiian wintering ground, on the other hand, is less well documented, and this congregation of whales is large and temporally stratified by age-sex class within a season. Sex or age-specific differences in behavior are more pronounced and may lead to a sighting bias. Accurate determination of the gender of individuals could be used to help correct for this potential heterogeneity. If overwintering in northern waters is common and influenced by age-sex class or reproductive status, some violation of the assumption of equal capture will occur regardless of the geographic fidelity of individuals to a particular breeding ground.

There is little doubt, however, that improved design and analysis could increase the accuracy of abundance estimates from both summer and winter grounds (Hammond, 1986). Most mark-recapture analyses of humpback whale populations have relied on relatively simple models. These analyses have also relied on photographic data that was collected nonsystematically or during research projects in which estimating abundance was a secondary concern. It would be desirable to use more complex mark-recapture models that integrate the growing body of data on the age-sex class of individuals and independent estimates of reproduction and mortality. These models could then be applied to photographs collected systematically during directed cruises. With these improvements, it should be possible to uncover and correct a considerable amount of heterogeneity that now exists in sighting records.

Reproductive rates

Sighting records of individually identified females provide a direct measure of current reproductive rates among humpback whales. Unlike estimates of pregnancy rate based on examination of carcasses in commercial catches, reproductive histories will eventually allow the partitioning of reproductive variance into individual, chronological and regional components.

Our analysis of the reproductive histories of females on the wintering and summering grounds of a single population revealed important differences between these two regions. Estimated calving rates of females on the Hawaiian wintering ground were substantially higher than those of females on the southeastern Alaska feeding grounds (0.58 calves/female/year in Hawaii compared to 0.37 in southeastern Alaska). Although some of this difference could be due to neonatal mortality during migration, evidence also suggests that our measurements of calving rates in Hawaii are inflated by behavioral characteristics that increase the probability of sighting a female during years that she is accompanied by a calf (Baker *et al.*, 1987). These behavioral characteristics include many of those that bias estimates of abundance: (1) pods with newborn calves surface more frequently and remain closer to shore than adult pods (Glockner and Venus, 1983); (2) cow-calf pairs are often at the center of conspicuous aggregations of male escorts competing for

proximity to the cow (Herman and Antinaja, 1977; Tyack and Whitehead, 1983; Baker and Herman, 1984a); (3) cow-calf pairs as a class tend to remain longer on the wintering grounds than resting or newly pregnant females (Chittleborough, 1965; Dawbin, 1966; Herman and Antinaja, 1977); and (4) resting or senescent females may not migrate to the wintering grounds every year.

As discussed previously, many of the biases affecting the sightability of individuals on the wintering grounds can be discounted on the feeding grounds: the smaller seasonal population; the high probability of regional return; and the prolonged seasonal residency of all age-sex classes help assure that individual females are sighted repeatedly and continuously across several years, regardless of the presence or absence of a calf. Inevitably, however, measurements of calving rates on the feeding grounds will be influenced by neonatal mortality (Clapham and Mayo, 1987; Baker *et al.*, 1987). Evidence of neonatal mortality from our sighting records includes the apparent loss of a calf between Hawaii and southeastern Alaska (Baker *et al.*, 1985) and the loss of a calf during the summer season in southeastern Alaska (Baker *et al.*, 1987). A direct estimate of neonatal mortality would be possible with more sighting records of individually identified females on both the summer and winter grounds. Such an estimate would be an extremely valuable contribution to our understanding of reproductive parameters in baleen whales.

Some negative bias in estimated calving rates based on sighting records could result from the inadvertent inclusion of yearly sightings prior to a female's sexual maturity (Baker *et al.*, 1987; Clapham and Mayo, 1987). Adjustments for this bias will be possible as the number and length of reproductive histories increases. Until extensive reproductive histories are available, care must be taken to avoid creating a further bias by inappropriately 'censoring' records. Simply omitting all sightings of an individual female prior to her first sighting with a calf, for example, will result in an inflated estimate of calving rates for those individuals. In our own analysis of reproductive histories we attempted to control for this bias by comparing the overall calving rate from the six-year study (1980-5) with the annual calving rates from only the last two years of the study. Since all but a few females were known to be mature by the last two years, a larger calving rate from this subset of the data would suggest the inclusion of immature females in the earlier years. No trend toward increasing calving rates was observed. The calving rate of these females during the 1986 season was also consistent with the overall estimate from all sample years combined (Baker *et al.*, 1988).

A positive bias in estimated calving rates from sighting records could result from the chance exclusion of females with unusually long calving intervals. Two of our sighting histories exemplify this potential bias. Animal number 250 was sighted without a calf in five nonconsecutive years across an eight year period. Based on this information alone, it would be tempting to assume that this animal was a male. Karyotyping from biopsy samples, however, has shown that this individual is a female (Lambertsen, Baker, Duffield and Chamberlin-Lea, 1988). Because she has never been sighted with a calf, she was not included in our analysis of reproductive rates (Baker *et al.*, 1987). Animal number 166, discussed in Baker *et al.*, (1987), was sighted in southeastern Alaska across six consecutive years without a calf. Jurasz and Palmer (1981), however, report that this individual was accompanied by a calf in 1974. Animal

number 166 has now been sighted an additional two years, for a total of eight consecutive years, without a calf (Baker, 1987). The question remains: Did Jurasz and Palmer (1981) incorrectly identify number 166 as a cow in 1974 or is she reproductively dysfunctional or senescent? Because of this uncertainty, number 166's sighting record was excluded from our estimate of calving rates (Baker *et al.*, 1987). Further determination of gender from cytogenetics and the continued documentation of reproductive histories among these and other individually identified female humpback whales (Glockner-Ferrari and Ferrari, 1984) are necessary to provide increasingly accurate measurements of population parameters in this species.¹

ACKNOWLEDGEMENTS

We are grateful to Michael Tillman, National Marine Fisheries Service, Washington, DC; Gordon Bauer, Psychology Department, University of Hawaii, Honolulu, HI; and two anonymous reviewers for their comments on this manuscript.

Photographic and sighting data reviewed here were obtained in association with research projects funded by various agencies and organizations. We are aware of the following sources of financial or logistical support: The National Park Service, Glacier Bay National Park and the Alaska Regional Office; the Auke Bay Laboratory, National Marine Fisheries Service (NMFS); the National Marine Mammal Laboratory, NMFS; The Center for Field Research; the Universities of Hawaii and Alaska Sea Grant College Programs; the National Science Foundation; The National Wildlife Federation; the Oceanic Society; the American Cetacean Society; and the US Forest Service, Admiralty Island Monument. All research was carried out under permits from NMFS.

The following people provided valuable technical assistance and logistical support during many of our research projects: Al Lovaas of the National Park Service, Alaska Regional Office; Don Chase and Gary Vequist of the Glacier Bay National Park and Preserve; Ken Krieger, George Snyder and Bruce Wing of the Auke Bay Laboratory; and Linda Jones, Sally Mizroch, Mary Nerini, Michael Tillman and the late James Johnson of the National Marine Mammal Laboratory.

Finally, we wish to thank the many researchers, who generously contributed photographs or sighting data for the catalog and other published works reviewed in this paper: Kelly Balcomb (North Gulf Oceanic Society); Marilyn Dahlheim (National Marine Mammal Laboratory, NMFS); Kirsten Englund (North Gulf Oceanic Society); Connie Ewald (Gulf of the Farallones Research Group); John Hall (Hubbs Sea World); John Heiser (Kenai Fjords National Park); Charles Jurasz (Sea Search); Bruce Kaye (Kenai Fjords National Park); Ronald Antinaja, Michael Aseltine, Gordon Bauer, Brooks Bays, Pierre Dawson, Paul Forestell, Adam Frankel, Michael Herder, Thomas Kieckhefer, Frank Minogue, Joseph Mobley, William Stifel, Barbara Taylor and Randy Wells (Kewalo Basin Marine Mammal Laboratory); William Lawton (Global Naturalists); Craig Matkin (North Gulf Oceanic Society); R. Colin Miller (North Gulf Oceanic Society); Jan Ostman

¹ Note added in proof. Molecular genetic techniques for the identification of sex have revealed that animal 166 is in fact a male (Baker, Lambertsen, Weinrich, Calambokidis and O'Brien, in review).

(University of California, Santa Cruz); Greg Kaufman (Pacific Whale Foundation); Robert Pitman (Southwest Fisheries Center, NMFS); John Reinke (American Cetacean Society); Jonathan Stern (University of California, Santa Cruz); Janice Straley (University of Alaska, Fairbanks); Isidore Szczepaniak (Gulf of the Farallones Research Group); Mark Towner (National Marine Mammal Laboratory, NMFS); Olga von Ziegesar (North Gulf Oceanic Society); Mark Webber (Gulf of the Farallones Research Group); Howard Winn (University of Rhode Island) and Allen Wolman (National Marine Mammal Laboratory, NMFS).

REFERENCES

- Alvarez, C., Aguayo, A., Rueda, R. and Urbán, J. 1990. A note on the stock size of humpback whales along the Pacific coast of Mexico. Paper SC/A88/ID27 (published in this volume).
- Baker, C.S. 1985. The population structure and social organization of humpback whales (*Megaptera novaeangliae*) in the central and eastern North Pacific. PhD dissertation, University Microfilms International, Ann Arbor. 306pp.
- Baker, C.S. 1986. Population characteristics of humpback whales in Glacier Bay and adjacent waters: Summer 1986. Final report to the National Park Service, Alaska Regional Office, Anchorage. (Unpublished). 30pp.
- Baker, C.S. 1987. Population characteristics of humpback whales in Glacier Bay and adjacent waters: Summer 1987. Final report to the National Park Service, Alaska Regional Office, Anchorage. (Unpublished). 13pp.
- Baker, C.S. and Herman, L.M. 1984a. Aggressive behavior between humpback whales (*Megaptera novaeangliae*) wintering in Hawaiian waters. *Can. J. Zool.* 62: 1,922-37.
- Baker, C.S. and Herman, L.M. 1984b. Seasonal contrasts in the social behavior of humpback whales. *Cetus* 5(2):14-16.
- Baker, C.S. and Herman, L.M. 1987. Alternate population estimates of humpback whales (*Megaptera novaeangliae*) in Hawaiian waters. *Can. J. Zool.* 65: 2,818-21.
- Baker, C.S., Perry, A. and Herman, L.M. 1987. Reproductive histories of female humpback whales *Megaptera novaeangliae* in the North Pacific. *Mar. Ecol. Prog. Ser.* 41:103-14.
- Baker, C.S., Herman, L.M., Perry, A., Lawton, W.S., Straley, J.M. and Straley, J.H. 1985. Population characteristics and migration of summer and late-season humpback whales (*Megaptera novaeangliae*) in southeastern Alaska. *Mar. Mammal Sci.* 1(3): 304-23.
- Baker, C.S., Herman, L.M., Perry, A., Lawton, W.S., Straley, J.M., Wolman, A.A., Kaufman, G.D., Winn, H.E., Hall, J.D., Reinke, J.M. and Ostman, J. 1986. Migratory movement and population structure of humpback whales (*Megaptera novaeangliae*) in the central and eastern North Pacific. *Mar. Ecol. Prog. Ser.* 31(2): 105-19.
- Baker, C.S., Straley, J.M. and Perry, A. 1988. Population characteristics of humpback whales in southeastern Alaska: Summer and late season 1986. Draft report to US Marine Mammal Commission, Washington. (Unpublished). 32pp.
- Baker, C.S., Perry, A. and Vequist, G. 1988. Humpback whales of Glacier Bay, Alaska. *Whalewatcher* 22(3):13-17.
- Begon, M. 1979. *Investigating Animal Abundance: Capture-recapture for Biologists*. University Park Press, Baltimore. 97pp.
- Calambokidis, J., Cabbage, J.C., Steiger, G.H., Balcomb, K.C. and Bloedel, P. 1987. Humpback whale (*Megaptera novaeangliae*) distribution and abundance in the Gulf of the Farallones, 1987. Second annual report for contract number CX 8000-6-0003 to Gulf of the Farallones National Marine Sanctuary, NOAA. (Unpublished). i-iv + 65pp.
- Carlson, C.A., Mayo, C.A. and Whitehead, H. 1990. Changes in the ventral fluke pattern of the humpback whale, *Megaptera novaeangliae*, and its affect on matching: evaluation of its significance to photo-identification research. Paper SC/A88/ID35 (published in this volume).
- Caughley, G. 1977. *Analysis of Vertebrate Populations*. John Wiley and Sons, Inc., New York. 228pp.
- Chapman, D.G. 1974. Status of Antarctic rorqual stocks. pp.218-38 In: W.E. Schevill (ed.) *The Whale Problem: a Status Report*. Harvard University Press, Cambridge. i-x + 419pp.
- Chittleborough, R.G. 1965. Dynamics of two populations of the humpback whale, *Megaptera novaeangliae* (Borowski). *Aust. J. Mar. Freshw. Res.* 16:33-128.
- Clapham, P.J. and Mayo, C.A. 1987. Reproduction and recruitment of individually identified humpback whales, *Megaptera novaeangliae*, observed in Massachusetts Bay, 1979-1985. *Can. J. Zool.* 65: 2,853-63.
- Darling, J.D., Gibson, K.M. and Silber, G.K. 1983. Observations on the abundance and behavior of humpback whales (*Megaptera novaeangliae*) off West Maui, Hawaii, 1977-79. pp.201-22 In: R. Payne (ed.) *Communication and Behavior of Whales*. Westview Press, Boulder. i-xii + 643pp.
- Darling, J.D. and Jurasz, C.M. 1983. Migratory destinations of North Pacific humpback whales (*Megaptera novaeangliae*). pp.359-68 In: R. Payne (ed.) *Communication and Behavior of Whales*. Westview Press, Boulder. i-xii + 643pp.
- Darling, J.D. and McSweeney, D.J. 1983. Observations on the migrations of North Pacific humpback whales (*Megaptera novaeangliae*). *Can. J. Zool.* 63:308-14.
- Darling, J.D. and Morowitz, H. 1986. Census of 'Hawaiian' humpback whales (*Megaptera novaeangliae*) by individual identification. *Can. J. Zool.* 64:105-11.
- Dawbin, W. H. 1966. The seasonal migratory cycle of humpback whales. pp.145-71 In: K.S. Norris (ed.) *Whales, Dolphins, and Porpoises*. University of California Press, Berkeley. i-xv + 789pp.
- Dohl, T.P., Guess, R.C., Duman, M.L. and Helm, R.C. 1983. Cetaceans of central and northern California, 1980-1983: Status, abundance, and distribution. Final report. MMS 84-0045, Contract 14-12-0001-29090. (Unpublished).
- Glockner, D. and Venus, S.C. 1983. Identification, growth rate, and behavior of humpback whale (*Megaptera novaeangliae*) cows and calves in the waters off Maui, Hawaii, 1977-79. pp.223-58 In: R. Payne (ed.) *Communication and Behavior of Whales*. Westview Press, Boulder. i-xii + 643pp.
- Glockner-Ferrari, D. and Ferrari, M. 1984. Reproduction in humpback whales, *Megaptera novaeangliae*, in Hawaiian waters. *Rep. int. Whal. Commn* (special issue 6): 237-42.
- Hall, J.D. 1979. A survey of cetaceans of Prince William Sound and adjacent vicinity - their numbers and seasonal movements. pp.631-726 In: *Environmental Assessment of the Alaskan Continental Shelf. Final Reports of the Principal Investigators, vol. 6. Biological Studies*. NOAA-OCSEAP, Boulder, Co.
- Hammond, P.S. 1986. Estimating the size of naturally marked whale populations using capture-recapture techniques. *Rep. int. Whal. Commn* (special issue 8): 253-82.
- Herman, L.M. 1979. Humpback whales in Hawaiian waters: a study in historical ecology. *Pac. Sci.* 33: 1-5.
- Herman, L.M. and Antinaja, R.C. 1977. Humpback whales in the Hawaiian breeding waters: population and pod characteristics. *Sci. Rep. Whales Res. Inst., Tokyo* 29: 59-85.
- Jurasz, C.M. and Palmer, V.P. 1981. Censusing and establishing age composition of humpback whales (*Megaptera novaeangliae*) employing photodocumentation in Glacier Bay National Monument, Alaska. Report to the National Park Service, Anchorage. (Unpublished). 44pp.
- Katona, S., Baxter, B., Brazier, O., Kraus, S., Perkins, J. and Whitehead, H. 1979. Identification of humpback whales by fluke photographs. pp.33-44 In: H.E. Winn and B.L. Olla (eds.) *Behavior of Marine Animals, vol. 3*. Plenum Press, New York. i-xix + 438pp.
- Katona, S.K. and Beard, J.A. Population size, migrations and feeding aggregations of the humpback whale (*Megaptera novaeangliae*) in the western North Atlantic. Paper SC/A88/ID2 (published in this volume).
- Kellogg, R. 1929. What is known about the migrations of some of the whalebone whales. *Annual Reports of the Smithsonian Institute for 1928*: 467-94.
- Krieger, K. and Wing, B.L. 1984. Humpback whale prey studies in Southeast Alaska, summer 1983. Northwest and Alaska Fisheries Center, Auke Bay Laboratory, Auke Bay. (Unpublished). 42pp.
- Krieger, K. and Wing, B.L. 1986. Hydroacoustic monitoring of prey to determine humpback whale movements. NOAA Technical Memorandum NMFS F/NWC-98. 62pp.
- Lambertsen, R.H., Baker, C.S., Duffield, D.A. and Chamberlin-Lea, J. 1988. Cytological (karyologic) confirmation of gender among individually identified humpback whales, *Megaptera novaeangliae*. *Can. J. Zool.* 66:1,243-48.

- Lillie, D.G. 1915. Cetacean. British Antarctic (Tera Nova) Expedition, 1910. *Natl. History Rep., Zool.* 1: 85-124.
- Mathews, L.H. 1937. The humpback whale, *Megaptera nodosa*. *Discovery Rep.* 17: 7-92.
- Matkin, C.O. and Matkin, D.R. 1981. Marine mammal survey of southwestern Prince William Sound 1979-1980. Report to the US Fish and Wildlife Service, Anchorage. (Unpublished). Unnumbered pp.
- Mobley, J.R. and Herman, L.M. 1985. Transience of social affiliations among humpback whales (*Megaptera novaeangliae*) on the Hawaiian wintering grounds. *Can. J. Zool.* 63: 762-72.
- Nemoto, T. 1964. Schools of baleen whales in the feeding areas. *Sci. Rep. Whales Res. Inst., Tokyo* 18: 89-110.
- Nerini, M.K., Braham, H.W., Marquette, W.M. and Rugh, D.J. 1984. Life history of the bowhead whale, *Balaena mysticetus* (Mammalia: Cetacea). *J. Zool., Lond.* 204:443-68.
- Perry, A., Baker, C.S. and Herman, L.M. 1985. The natural history of humpback whales in Glacier Bay, Alaska. Final report to the National Park Service, Alaska Regional Office, Anchorage. (Unpublished). 41pp.
- Perry, A., Mobley, J.R., Baker, C.S. and Herman, L.M. 1988. *Humpback Whales of the Central and Eastern North Pacific: A Catalog of Individual Identification Photographs*. Sea Grant Miscellaneous Report, UNIH-SEAGRANT-MR-88-02, Honolulu. i-ix + 37pp + C1-158 + I1-38.
- Reilly, S.B. 1984. Observed and maximum rates of increase in gray whales, *Eschrichtius robustus*. *Rep. int. Whal. Commn* (special issue 6): 389-99.
- Rice, D.W. 1978. The humpback whale in the North Pacific: distribution, exploitation, and numbers. pp.29-44. In: K.S. Norris and R. Reeves (eds.) Report on a Workshop on Problems Related to Humpback Whales (*Megaptera novaeangliae*) in Hawaii. US Marine Mammal Commission, Washington, DC 90pp.
- Rice, D.W. and Wolman, A.A. 1971. The life history and ecology of gray whales, *Eschrichtius robustus*. *Am. Soc. Mamm. Spec. Publ.* 3: 1-142.
- Rice, D.W. and Wolman, A.A. 1982. Whale census in the Gulf of Alaska, June to August 1980. *Rep. int. Whal. Commn* 32: 491-98.
- Rice, M., Carlson, C., Chu, K., Dolphin, W. and Whitehead, H. 1987. Are humpback whale population estimates being biased by sexual differences in fluking behaviour? *Rep. int. Whal. Commn* 37:333-5.
- Schevill, W.E. and Backus, R.H. 1960. Daily patrol of a *Megaptera*. *J. Mamm.* 41: 279-81.
- Seber, G.A.F. 1982. *The Estimation of Animal Abundance and Related Parameters*. MacMillan Publishing Co., New York. 645pp.
- Tyack, P. and Whitehead, H. 1983. Male competition in large groups of wintering humpback whales. *Behaviour* 83: 132-54.
- Urban, J. and Aguayo, A. 1987. Spatial and seasonal distribution of the humpback whale, *Megaptera novaeangliae*, in the Mexican Pacific. *Mar. Mamm. Sci.* 3(4): 333-44.
- Von Zeigesar, O. and Matkin, C.O. 1986. Humpback whales in Prince William Sound in 1985. Report for contract no. 41 USC 252 to National Marine Mammal Laboratory, NOAA. (Unpublished). Unnumbered pp.

Note added in proof

Recent review of North Pacific humpback identification photographs by S. Mizroch and D. Rice has discovered that a whale previously reported as being off Socorro Island, Mexico in 1978 was actually seen off the Tres Marias Islands, Mexico in that year. The movement of this whale from Prince William Sound, Alaska in 1977 to Socorro Island the following year, reported by Baker *et al.* (1986), is therefore incorrect. Perry *et al.* (1988) refer to this whale as Observation No. 679 in Alaska, Observation No. 2647 in Mexico and Resight No. 298.

Fall and Winter Occurrence of Humpback Whales (*Megaptera novaeangliae*) in Southeastern Alaska

Janice M. Straley

Institute of Marine Science, University of Alaska Fairbanks, Fairbanks, Alaska 99775, USA

and

PO Box 273, Sitka, Alaska 99835, USA

ABSTRACT

Humpback whales (*Megaptera novaeangliae*) were individually identified during the fall and winters of 1979–86 in southeastern Alaska. Most of the identified whales were seen only once (not resighted) during the study period. Peak sightings occurred in late November and early December, with a slow decline through January. Occasional sightings were made through the rest of the winter. Although whales were sighted in every month of the year, no single whale was documented to remain throughout the winter. There was no apparent delineation by age or sex, as known females in at least three reproductive stages (resting, lactating and pregnant), calves and mature males were present. There is evidence that behaviour associated with mating begins on the feeding grounds, as 'singing' and aggressive interactions between males were observed in the study area. The factors determining the timing of the whales southward migration are more complex than mere seasonal cues and the timing is flexible for individual whales.

INTRODUCTION

During the early 1900s, shore-based whaling in southeastern Alaska took humpback whales, *Megaptera novaeangliae*, and fin whales, *Balaenoptera physalus*, (Andrews, 1909). With the advent of alternative oil sources and the decline in the availability of whales, all whaling stations along this coast were closed by 1922 (Anon, 1971; Rice and Wolman, 1975; Inglis and Haggarty, 1985).

The status of both species in southeastern Alaska from the 1930s-60s is unclear. Fin whales have not returned to their historical feeding areas in southeastern Alaska, but humpback whales are present and have been studied by numerous researchers since 1968 (e.g. Rice and Wolman, 1975; Jurasz and Jurasz, 1979; Darling and McSweeney, 1985; Baker, Herman, Perry, Lawton, Straley and Straley, 1985; Dolphin, 1987).

The North Pacific population of humpback whales, which is thought to number around 1,200 whales (Rice and Wolman, 1982), are seasonal migrants, breeding in the warmer, sub-tropical waters of Mexico and Hawaii and feeding on zooplankton and small schooling fishes in the cool, subarctic coastal waters of Alaska. Humpback whales begin to arrive in Hawaiian waters in November, with numbers peaking in February and declining by late June or early July (Norris and Reeves, 1978). No humpback whales are sighted off Hawaii from July to October (Norris and Reeves, 1978). Humpbacks are sighted off Mexico during every season of the year (Urbán and Aguayo, 1987).

The southeastern Alaskan feeding stock, estimated to be 374 whales (Baker, Herman, Perry, Lawton, Straley, Wolman, Kaufman, Winn, Hall, Reinke and Östman, 1986), arrives in Alaskan waters in late spring and departs southward for the breeding grounds in late summer or early fall (Cuccarese and Evans, 1981). Local residents of southeastern Alaska have noted the year-round occurrence of humpback whales, however, and Berzin and Rovnin (1966) reported the presence of humpback whales in the eastern Aleutian Islands in December. Ingebrigtsen

(1929) reported that, around the turn of the century, humpback whales, including females with near term fetuses, were caught off Norway during the winter.

This paper documents and discusses the presence of humpback whales during the late fall and winter in two areas of southeastern Alaska from 1979–86.

METHODS

Individual whales were photographically identified by natural markings on the ventral fluke surfaces (Katona, Baxter, Brazier, Kraus, Perkins and Whitehead, 1979). Whales were photographed with a 35mm SLR camera with a 70–210 mm zoom lens using high speed black and white print film (400ASA) or colour slide film (200 and 400ASA). Small inflatables and fibreglass and aluminium skiffs equipped with 25hp or 35hp outboard engines were used to approach and photograph individual whales.

All photographs of individual whales were logged with date, social grouping (if determined) and location, and compared with the humpback fluke photographs on file at the Kewalo Basin Marine Mammal Laboratory (KBMML), University of Hawaii Manoa (Baker *et al.*, 1985). Fluke photographs were rated to be of good, fair or poor quality based on sharpness, contrast and fluke angle. Good and fair photographs showed 50% of each fluke at an angle sufficient to show the shape of the trailing fluke edge, the outline of which was also used as a natural individual identifying tag. Poor quality photographs and photographs of calf flukes were excluded from analyses of abundance.

Photographs of individual whales were also filed with the North Pacific humpback whale fluke identification catalog located at the National Marine Fisheries Service, National Marine Mammal Laboratory, Seattle, WA, USA.

The study was conducted in two areas of southeastern Alaska (Fig. 1) during the fall and winters of 1979–86: (1) Seymour Canal (the primary study area) which is a long, narrow fjord along the east side of Admiralty Island,

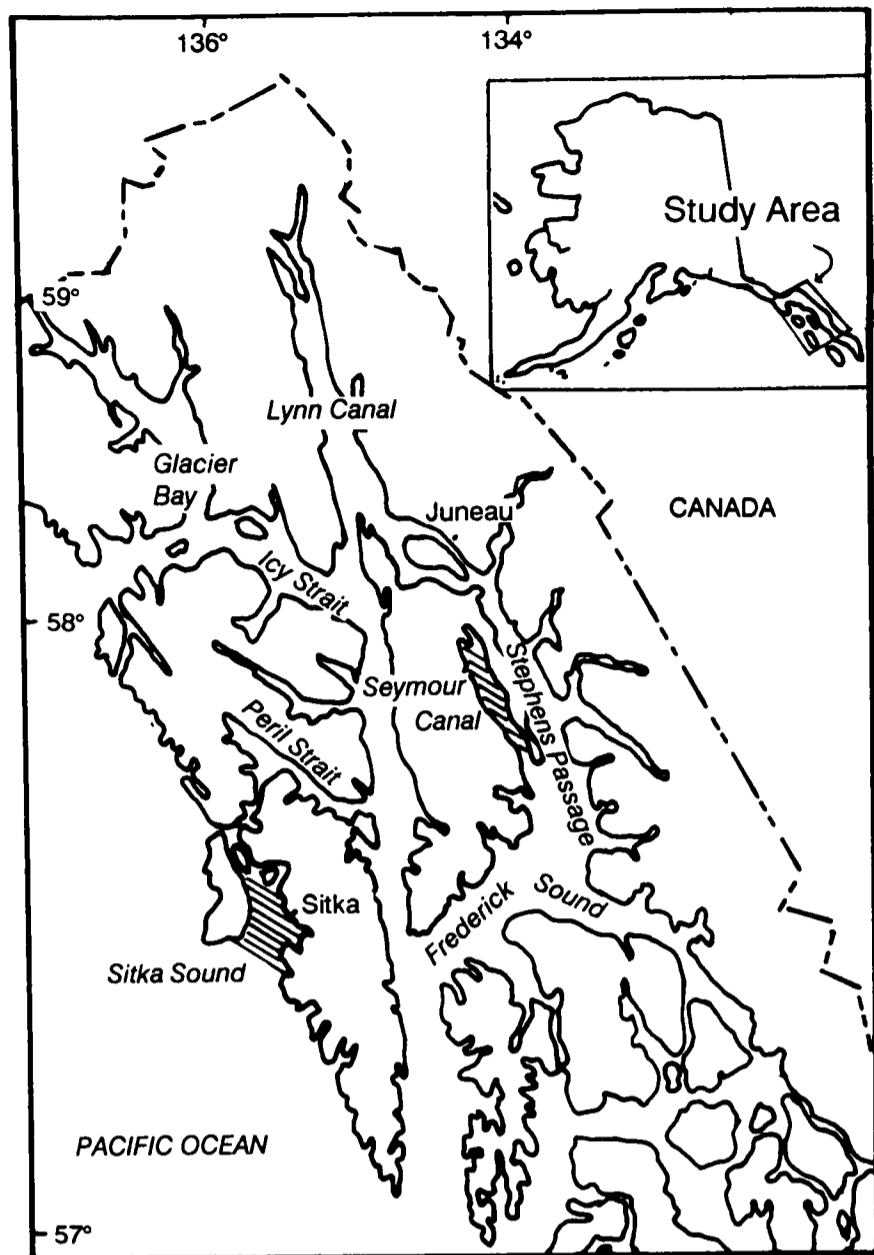

Fig. 1. The southeastern Alaska study areas.

bordered by Stephans Passage to the south; and (2) Sitka Sound which is located near the city of Sitka along the outer coast of southeastern Alaska, bounded by Baranof Island and the Pacific Ocean. Sitka Sound is one of the principal entrances to the inside waters of southeastern Alaska, hence it is a transition zone between the waters of the archipelago and the Gulf of Alaska. As such, it is exposed to rougher seas and more severe weather than are inside waters such as Seymour Canal.

During the fall and winter, survey efforts were opportunistic and often sporadic as dictated by the weather and limited daylight (4hrs/day useable light). On average, it was possible to work on the water on one day in three.

All observations occurred during the day except on a few occasions where humpbacks were observed at night from a larger vessel in Seymour Canal. Study periods ranged from October to March (Table 1) but centred around late November to early January and were variable for area and year. Late winter and early spring (March) sightings were documented for Sitka Sound, but identification photographs were not consistently taken, and are not included in the data analyses.

Shore-based and skiff surveys were conducted for most years and locations (Table 1).

Population estimates were calculated using the open population Jolly-Seber estimator (Seber, 1982). Seasons 1 and 2 were pooled because there were no resightings in the second season.

Table 1

Fall and winter study periods and areas

Area	Study period
Seymour Canal	18 November 1979 - 7 March 1980
	18 November 1980 - 7 January 1981
	18 November - 4 December 1981
	23 November - 10 December 1982
	8 November 1983
	1 December - 9 December 1985
29 November - 10 December 1986	
Sitka Sound	8 October 1980 - 16 November 1980
	14 December 1981
	20 October 1982 - 23 January 1983
	6 November 1983 - 6 February 1984
	26 October - 20 December 1984
	5 October - 21 November 1985
	15 October - 22 December 1986

RESULTS

Seasonal distribution and numbers

Seymour Canal

The larger aggregation of whales was found in Seymour Canal during late fall and early winter. The general pattern was for a peak in sightings in late November with a gradual decline through December. A few scattered sightings were made in January and February. Peak counts obtained from shore or skiff surveys ranged from 26 to 61 whales per year (Table 2). Total whales photo-identified per year ranged from a low of 0 in 1983 and 1984 (no surveys) to a high of 82 in 1982 (Table 3). Over the eight year study period, 247 photo-identifications were made of 181 different whales in Seymour Canal. Most (70%) were sighted only once, with very few (5%) identified in 3 or 4 seasons (Fig. 2). Estimates of total numbers, using an open population estimator (Jolly-Seber), resulted in an average yearly population estimate of 205 whales (SE=47, CV=23% (Table 4).

Table 2

Seymour Canal peak daily count per year

Year	Peak number	Date
1979-80	35	25 November
1980-81	34	21 November
1981	28	23 November
1982	61	4 December
1983	26	8 November (aerial survey)
1984	No Survey	
1985	42	3 December
1986	44	3 December

Table 3

Humpback whales photo-identified each year in Seymour Canal. These numbers include whales seen in more than one year

Year	Number photo-identified
1979-80	11
1980-81	9
1981	45
1982	82
1985	46
1986	54

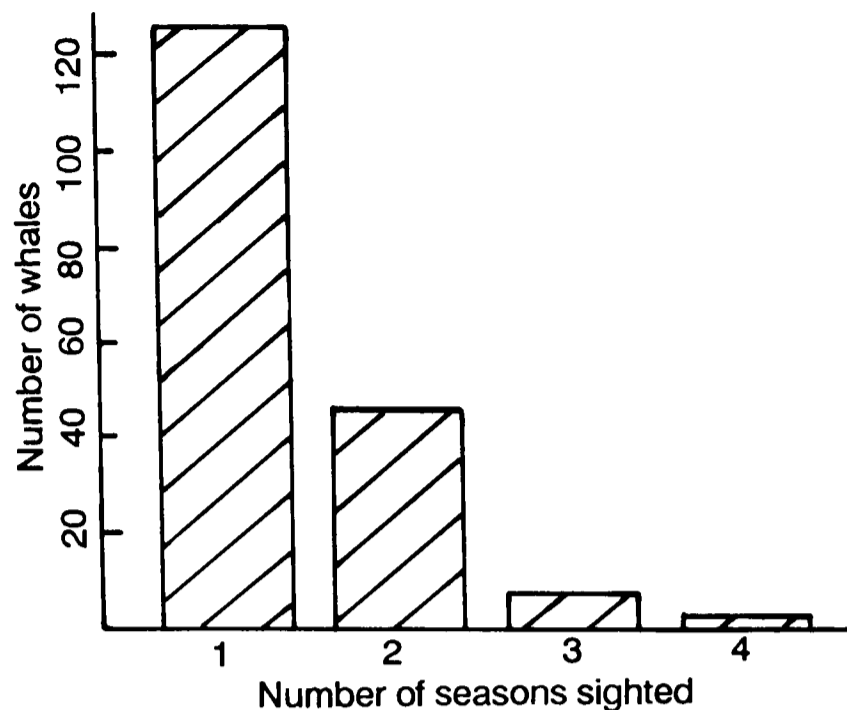

Fig. 2. Numbers of whales sighted in 1,2,3 or 4 years in Seymour Canal.

Table 4

Population estimates for Seymour Canal from mark-recapture, open population, Jolly-Seber Estimator (Seber, 1982)

Year	Number	SE	CV
1979-80/1980-81	230	129	
1981	193	101	
1982	205	50	
1985	190	74	
1986	-	-	
Average	205	47	23%

Sitka Sound

Sitka Sound consistently had fewer whales than Seymour Canal. The seasonal trend was similar, however, with whales arriving in October and staying through December or mid-January, and only an occasional whale sighted in late January and early February. Annual fall and winter peak counts ranged from 2 to 10 whales for the seven year study period (Table 6). Sightings of humpback whales during March were coincident with the spawning of Pacific herring (*Clupea harengus pallasii*). The total number of whales photo-identified was 16 (Table 7). Of these, 14 (87.5%) were seen once in this area and two (12.5%) were seen in three of the seven years. Due to the low numbers of whales identified, no mark-recapture population estimates were calculated.

Table 5

Sitka Sound peak daily count during season

Year	Number	Date
1980	6	14 November
1981	2	14 December
1982-83	5	15 January
1983-84	10	15 January
1984	8	12 November
1985	5	5 October
1986	4	22 December

Table 6

Humpback whales photo-identified each year in Seymour Canal. These numbers include whales seen in more than one year

Year	Number photo-identified
1980	0
1981	2
1982-83	1
1983-84	8
1984	5
1985	0
1986	4
Total	20

Table 7

Reproductive stages of some females during the Fall-Winter 1979-86

No.	1980	1981	1982	1983	1984	1985	1986
1	-	-	-	-	-	PREG	LACT ²
2	-	-	-	-	-	PREG	LACT ²
3	-	REST	PREG ¹	-	-	-	LACT
4	LACT	-	-	-	-	-	-
5	-	-	REST ¹	-	-	-	-
6	-	PREG	LACT	-	-	-	-
7	-	-	-	-	REST	-	LACT
8	-	-	-	-	-	-	LACT
9	-	-	LACT	-	-	-	-
10	-	REST	PREG ¹	-	-	-	-
11	-	-	REST ¹	-	-	PREG	LACT ²
12	-	-	PREG ¹	-	-	-	LACT
13	-	-	-	-	-	PREG	LACT ²
14	-	-	-	-	REST	-	LACT ²

¹ Data gathered by Dr. C.S. Baker during the summer assisted in documenting reproductive stage of some fall-winter whales.
² summer

Group composition

Comparisons made between the fluke photographs taken during this study with those published in the KBMML fluke catalog (Perry, Mobley, Baker and Herman, 1988) and collaboration with University of Hawaii researchers provided a description of the sex, relative age and reproductive state of several humpbacks sighted in Seymour Canal and Sitka Sound. Mature females in three reproductive stages (lactating, pregnant and resting) were observed (Table 8). Lactating females with calves less than a year old were seen in both study areas in October, November, December and January. Pregnant females were seen the following year with a calf and resting females were seen in subsequent years as pregnant and then with a calf. Resting refers to females that are post-lactation and pre-conception and are physically able to become pregnant but wait or 'rest' a year or more before becoming pregnant.

'Singing', which is thought to be a mating display specific to mature males (Tyack, 1981; Baker and Herman, 1984a), was heard on 29 December 1979 and 5 January 1980 in Seymour Canal. The 'songs', although not recorded, were heard through the hull of a stationary fibreglass skiff and lasted for 15-20 minutes.

Only one whale was thought to be singing on each occasion. One of the identified whales in the area at the time the song was heard was observed as an 'escort' in Hawaii. Previous studies have suggested that 'escort' whales are males (Glockner-Ferrari and Ferrari, 1985).

Table 8

Sighting histories and seasonal movement for some individual humpback whales in Southeastern Alaska

Number	Dates	Year	Area
22	4 December	1982	Seymour Canal
	13 May	1987	Sitka Sound
68	20-30 December	1979	Seymour Canal
	early November	1985	Kelp Bay ¹
	7 December	1985	Seymour Canal
	1 August	1986	Frederick Sound
206	23 November	1981	Seymour Canal
	1 December	1982	Seymour Canal
	21 June	1984	Sitka Sound
	mid- August	1985	Sitka Sound
	21 June	1987	Sitka Sound
224	1 December	1982	Seymour Canal
	1 September	1985	Frederick Sound
	11 December	1986	Sitka Sound
268	20 November	1980	Seymour Canal
	8 December	1985	Gambier Bay
	15 June	1986	Sitka Sound
	29 November	1986	Peril Strait
560	1 December	1982	Seymour Canal
	early November	1985	Kelp Bay ¹
	7 December	1985	Seymour Canal
	30 August	1986	Frederick Sound
916	5 January	1984	Ulloa Channel
	9 July	1986	Sitka Sound

¹ Photo courtesy of NOAA ship *Fairweather*.

Aggressive behaviour between two individuals and among individuals in groups was observed during early December 1985 and 1986, which differs from the more placid behaviour generally seen during the summer in Alaskan waters. This consisted of headlunges and charging; no body strikes were seen. Such behaviour also is assumed to be performed by mature males (Baker and Herman, 1984a).

Movement between areas and residency

Not all individual whales stayed in one fall or winter feeding area. For example, some whales moved between areas in different years and seasons. Cow 916, photo-identified with a calf in Ulloa Channel, near the town of Craig in southern southeastern Alaska, in January 1984, was next sighted in Sitka Sound with another calf in July 1986. Whale 224 was seen in Seymour Canal in December 1982 but was seen in Sitka Sound in December 1986. Table 9 gives sighting histories and seasonal movements for some representative whales. Whale 268 has been identified in Seymour Canal and Sitka Sound in different years and has been seen in areas between these two areas, as well. This individual has the longest confirmed residency within the same calendar year (5.5 months) of any whale identified in southeastern Alaska during this study. In 1986 the earliest photo-identification of whale 268 was on 15 June and the last sighting was on 29 November. No whale was observed continuously from a fall or winter through the following spring and summer. Over 150 whales have only been photo-identified in a single area and only during the fall or winter.

Feeding behaviour

Several types of feeding behaviour have been observed during the fall and winter. Vertical, horizontal and echelon lunge-feeding (Jurasz and Jurasz, 1979; Baker and

Herman, 1984b) were observed in nearly all years in Sitka Sound and Seymour Canal. Vertical and horizontal lunge-feeding were always associated with the blowing of bubble-nets to concentrate prey. Bubbles were blown or released at depth, and as they rose, acted as a net to concentrate prey near the surface. When the bubbles reached the surface, usually in a circle or figure eight configuration, the 'net' was completed, and the whales immediately lunged with open mouth through the concentrated prey. Groups of lunge-feeding whales ranged in size from 1-12 whales. Activities presumed to be subsurface feeding also were observed. Whales would dive and, in 3-15 minutes, resurface at or near the same location. Often schooling fish, euphausiids, diving seabirds and other marine mammals were seen near these whales. It can only be assumed that the whales were feeding at depth. In Seymour Canal feeding was not observed at night; on a few occasions when it was observed at dusk, the whales moved toward shore and appeared to rest. They reassembled the next morning at first light and began feeding again. Whether the whales in Sitka Sound continue to feed at night is unknown.

Through echo sounder recordings, visual identification and qualitative sampling, the prey were judged to be mostly euphausiids and Pacific herring. Two fecal samples collected by the author (Seymour Canal, November 1982; Sitka Sound, November 1983) were analysed (B. Wing, pers. comm.). Mostly euphausiid parts were found in both samples. The Seymour Canal sample contained uropods, telsons, antennal scales and a few eyes. The Sitka Sound sample contained carapace remnants, abdominal segments, a few uropods and antennal scales. Identification to species was not carried out. No evidence of fish was found in either sample. Visual observation and qualitative sampling after a bubble-net/lunge-feeding episode, in Sitka Sound in 1986, demonstrated the presence of Pacific herring 20cm in length. Sitka Sound is a major wintering and spawning ground for Pacific herring (Blankenbeckler, 1977; D. Ingledue, pers. comm.).

DISCUSSION

Humpback whales are present in southeastern Alaska in all months of the year. No one whale has been documented to overwinter or stay year-round. Whales present in the fall, winter and early spring appear to be irregular migrants, some being late to depart and others being early to arrive on the feeding grounds. Humpback whales last sighted in Alaskan waters in late fall or winter have been resighted during the same and later seasons in Hawaii or Mexico (Baker *et al.*, 1985; 1986). Overwintering may take place in southeastern Alaska but is probably rare, for it has not yet been detected. No individual has been seen from fall to spring in Alaskan waters.

The Seymour Canal area has the largest known fall and winter aggregation in southeastern Alaska with an estimated 193 to 230 whales per year over the eight years of this study. If the population of whales utilising southeastern Alaska each year is almost 400, as estimated by Baker *et al.* (1986), many of them may be feeding there in the fall and winter. The implications of this are significant. This potential feeding opportunity may be important to whales arriving on the feeding grounds late or those in need of additional calories to survive the migration and the demands of mating or calving on the breeding grounds.

The assumptions of the Jolly-Seber open population estimator may have been violated during this study (Seber, 1982; Hammond, 1986). Most importantly, it is not known whether or not the whales which are present in fall and winter in southeastern Alaska are the same whales each year. The unavailability of whales to be photographed in every year is known as temporary emigration; there is no way to account for this in estimation of population size unless the pattern of absence is known. The violation of the assumption of equal catchability would lead to negative bias or underestimation of population size (Hammond, 1986; Seber, 1982). It is unlikely that all whales have the same 'catchability', as fluking behaviour varies greatly and some whales are much easier to photograph than others. Because the model assumptions may have been violated the population estimates calculated for the fall and winter whales of southeastern Alaska should be used with caution and only as a general indicator of population size.

During the 1987/88 season (not included in this paper), there were numerous reports of pods of humpback whales just off the outside coast of Baranof and Kruzof Islands, areas inaccessible by small skiff. In addition, there are other areas of southeastern Alaska with reported small aggregations of whales during the fall and winter, that have not yet been studied. Both the outer and inner waters need further study if better estimates of numbers of late-leavers and early-arrivers are to be determined and the significance of such behaviour to be better understood.

The factors governing the timing of the southbound migration of humpback whales from Alaskan waters to Hawaii and Mexico appear to be more complex than mere seasonal cues. This timing appears to vary among individual whales and among years. The reasons for this flexibility are unknown but may be tied to factors such as prey availability, oceanographic conditions and individual needs of each whale. This research has only documented the presence of humpback whales in Alaskan waters during the fall and winter months and shown that the timing of migration is irregular for individuals within the Alaskan feeding stock.

ACKNOWLEDGEMENTS

This research was encouraged first by K.J. Metcalf of Angoon, Alaska and supported at various times by Admiralty Island National Monument, Juneau, Alaska, the US Forest Service, Tongass National Forest, Sitka, Alaska, the National Marine Fisheries Service, Sitka, Alaska, the National Marine Fisheries Service, National Marine Mammal Laboratory, Seattle, Washington, Drs J. and C. Greenough and their vessels *Raven* and *Chichagof* and C. Johnstone and his vessel *Fairweather*, all of Sitka, Alaska. I should like to thank J. Straley, K. Hazard, S. Reifstahl and S. Warner for their field assistance. In addition I would like to thank Dr F. Fay, Dr C.S. Baker and A. Perry for their helpful comments in review of an earlier draft of this manuscript (their addresses are University of Alaska, Fairbanks 99775, USA; Victoria University of Wellington, PO Box 600, Wellington, New Zealand; and 178 Melbourne Road, Island Bay, Wellington, New Zealand). This research was conducted under National Marine Fisheries Permit to take Endangered Marine Mammals Number 571.

REFERENCES

- Andrews, R.C. 1909. Observations on the habits of the finback and humpback whales of the Eastern North Pacific. *Bull. Amer. Mus. Nat. Hist.* 26: 213-6.
- Anonymous. 1971. Whalers of Murder Cove. *Alaska Journal* 1: 22-4
- Baker, C.S. and Herman, L.M. 1984a. Aggressive behaviour between humpback whales, *Megaptera novaeangliae*, wintering in Hawaiian waters. *Can. J. Zool.* 62: 1,922-37.
- Baker, C.S. and Herman, L.M. 1984b. Seasonal contrasts in the social behaviour of the humpback whale. *Cetus* 5(2): 14-6.
- Baker, C.S., Herman, L.M., Perry, A., Straley, J.M. and Straley, J.H. 1985. Population characteristics and migration of summer and late-season humpback whales (*Megaptera novaeangliae*) in southeastern Alaska. *Mar. Mamm. Sci.* 1:304-23
- Baker, C.S., Herman, L.M., Perry, A., Lawton, W.S., Straley, J.M., Wolman, A.A., Kaufman, G.D., Winn, H.E., Hall, J.D., Reinke, J.M. and Östman, J. 1986. Migratory movement and population structure of humpback whales (*Megaptera novaeangliae*) in the central and eastern North Pacific. *Mar. Ecol. Prog. Ser.* 31: 105-19
- Berzin, A.A. and Rovnin, A.A. 1966. The distribution and migration of whales in the northeastern part of the Pacific Ocean and in the Bering Sea and the Sea of Chukotsk. *Izv. TINRO* 58: 179-207
- Blankenbeckler, D. 1977. pp.91-3. In: D. Blankenbeckler (ed.) Proceedings of the Third Pacific Coast Herring Workshop, June 22-23, 1976. Fish. Res. Bd Can., Ms. Rep. Ser. No. 1421
- Cuccarese, S.V. and Evans, C.D. 1981. The North Pacific Humpback Whale (*Megaptera novaeangliae*): Its status on Alaska grounds. Draft Issue Paper. Arctic Environmental Information and Data Center, Anchorage, Alaska. Presented to the meeting to review ongoing and planned research concerning humpback whales in Glacier Bay and surrounding waters in southeast Alaska, Dec 1981 (unpublished). 135pp.
- Darling, J.D. and McSweeney, D.J. 1985. Observations on the migration of North Pacific humpback whales *Megaptera novaeangliae*. *Can. J. Zool.* 63: 308-14
- Dolphin, W.F. 1987. Dive behaviour and estimated energy expenditure of foraging humpback whales in southeastern Alaska. *Can. J. Zool.* 65: 354-62
- Glockner, D.A. and Ferrari, M.J. 1985. Individual identification, behaviour, reproduction and distribution of humpback whales, *Megaptera novaeangliae*, in Hawaii. Report to US Marine Mammal Commission, No. MMC-83/06. 49pp.
- Hammond, P.S. 1986. Estimation the size of naturally marked whale populations using capture-recapture techniques. *Rep. int. Whal. Commn* (special issue 8): 253-82
- Ingebrigtsen, A. 1929. Whales caught in the North Atlantic and other seas. *Rapp. P.-V. Réun. CIEM* 56(2): 1-26
- Inglis, R.I. and Haggarty, J.C. 1985. Humpbacks off port bow. *Wildlife Review* (Spring): 25-7
- Jurasz, C.M. and Jurasz, V.P. 1979. Feeding modes of the humpback whale *Megaptera novaeangliae* in southeast Alaska. *Sci. Rep. Whales Res. Inst., Tokyo* 31: 69-83
- Katona, S., Baxter, B., Brazier, O., Kraus, S., Perkins, J., and Whitehead, H. 1979. Identification of humpback whales by fluke photographs. pp.33-44. In: H.E. Winn and B.L. Olla (eds.) *Behaviour of Marine Mammals*. Vol. 3. Plenum Press, New York.
- Norris, K.S. and Reeves, R. 1978. p.5. In: K.S. Norris and R. Reeves (eds.) Report on a workshop on problems related to humpback whales (*Megaptera novaeangliae*) in Hawaii. US Marine Mammal Commission, Washington, DC, USA. 25pp.
- Perry, A., Mobley, J., Baker, C. and Herman, L. 1988. Humpback whales of the central and eastern North Pacific: a catalog of individual identification photographs. Sea Grant Misc. Rep., UNHI-SEAGRANT-MR-87-00, Sea Grant Publications, University of Hawaii, Honolulu.
- Rice, D.W. and Wolman, A.A. 1975. The humpback whales of southeastern Alaska: aerial and vessel censuses. Report to US National Marine Fisheries Service, National Marine Mammal Laboratory, Seattle, WA, USA. 20pp.
- Rice, D.W. and Wolman, A.A. 1982. Whale census in the Gulf of Alaska, June to August 1980. *Rep. int. Whal. Commn* 32: 491-8
- Seber, G.A.F. 1982. *The Estimation of Animal Abundance and Related Parameters*. Griffin, London. 2nd Edition. 654pp.
- Tyack, P. 1981. Interactions between singing humpback whales and conspecifics nearby. *Behav. Ecol. and Sociobiol.* 8: 105-6.
- Urbán, J.R. and Aguayo, A.L. 1987. Spatial and seasonal distribution of the humpback whale, *Megaptera novaeangliae*, in the Mexican Pacific. *Mar. Mamm. Sci.* 3: 333-44.

Population Estimates of Humpback Whales in the Gulf of the Farallones, California

John Calambokidis, James C. Cubbage, Gretchen H. Steiger

Cascadia Research, 218 I/2 West Fourth Avenue, Olympia, Washington 98501, USA

and

Kenneth C. Balcomb and Prentice Bloedel

Center for Whale Research, 1359 Smugglers Cove Road, Friday Harbor, Washington 98250, USA

ABSTRACT

We examined population estimates of humpback whales (*Megaptera novaeangliae*) based on photo-identification and aerial surveys in the Gulf of the Farallones, California. Population estimates for 1986–8 were made within years, between years and among years; methods used to estimate population size included the total number of individuals identified, the rate of discovery, mark-recapture estimators (Petersen estimator with the Chapman and Bailey modifications and Jolly-Seber method) and aerial line-transect calculations. We found a number of violations of mark-recapture assumptions in our data; the most serious was the lack of a defined closed population. Heterogeneity of capture probability was observed, particularly in the occurrence of a sub-group of whales that was more likely than others to return to the region. Assuming that within-year estimates were accurate, 22% and 17% of whales present in 1986 and 1987, respectively, did not return the following year; 54% and 35% of whales present in 1987 and 1988, respectively, had not been present the previous year. All abundance estimates based on photo-identification, including the number of individuals identified, were higher than estimates from aerial line-transects even when an attempt was made to correct the latter for whales submerged and undetected. Estimates of abundance based on between-year samples at a feeding area may be seriously biased unless whales in the entire region are sampled randomly.

INTRODUCTION

Cetacean abundance has been estimated using mark-recapture techniques based on individually identified whales of several different species including humpback whales (e.g. Whitehead, 1982; Katona and Beard, 1990). The calculations and assumptions of the various mark-recapture models have been reviewed by Seber (1982) and their application to individually identified cetaceans reported by Hammond (1986). In the North Atlantic, methods for estimating humpback whale abundance have varied both in the estimators employed and the sampling strategy. The most commonly used procedures to estimate humpback whale populations have been the two-sample Petersen estimate (Whitehead, 1982; Whitehead, Chu, Perkins, Bryant and Nichols, 1983; Balcomb and Breiwick, 1984; Perkins, Balcomb, Nichols and DeAvilla, 1984; Perkins, Balcomb, Nichols, Hall, Smultea and Thumser, 1985; Whitehead and Glass, 1986; Balcomb, Katona and Hammond, 1986; Baker and Herman, 1987; Alvarez, Aguayo, Rueda and Urbán, 1990; Katona and Beard, 1990) and the Jolly-Seber multiple sample model (Whitehead, 1982; Hammond and Larsen, 1985; Whitehead and Glass, 1985; Baker and Herman, 1987). Other methods include the Schnabel estimator (Perkins and Whitehead, 1977; Whitehead *et al.*, 1983) and the estimate for the saturation number for the rate of discovery of new whales (Darling and Morowitz, 1986; Alvarez *et al.*, 1990; Katona and Beard, 1990). Even with a given procedure such as the Petersen estimate, however, strategies for delineating the two samples have varied. These pairs of samples have included: (1) within-year samples at a feeding or breeding area during two time periods in one season; (2) within-year samples in an area using different vessels from which photos were taken as the samples; (3) within-year samples in a region using specific locations as the division between samples; (4)

between-year samples for the same breeding or feeding location; and (5) feeding and breeding area samples in adjacent seasons.

These procedures involve different potential violations of one of the principal assumptions of the Petersen estimate, namely that the population is closed. Similarly, the samples must be taken from a clearly-defined population so that the estimates have practical meaning. Between-year estimates of humpback whales on North Atlantic feeding grounds have relied on the general site fidelity of humpback whales at these areas (Perkins *et al.*, 1984; Katona and Beard, 1990). The population of the whales in these areas was thereby considered defined and closed (with the exception of natality and mortality between samples).

Humpback whales have been studied and individually identified at feeding areas in the eastern North Pacific including the Gulf of Alaska (Baker, Herman, Perry, Lawton, Straley, Wolman, Kaufman, Winn, Hall, Reinke and Ostman, 1986), southeastern Alaska (Darling and Jurasz, 1983; Darling and McSweeney, 1985; Baker *et al.*, 1986), Prince William Sound (Darling and McSweeney, 1985; von Ziegesar and Matkin, 1986; Baker *et al.*, 1986), Vancouver Island (Darling and McSweeney, 1985), and central California (Baker *et al.*, 1986; Calambokidis, Steiger, Cubbage, Balcomb and Bloedel, 1989). Some individuals from all these feeding areas have been identified at breeding grounds in Mexico and Hawaii (Darling and McSweeney, 1985; Baker *et al.*, 1986; Urbán, Balcomb, Alvarez, Bloedel, Cubbage, Calambokidis, Steiger and Aguayo, 1987; Calambokidis *et al.*, 1989). Some interchange has occurred between some areas in Alaska and off Vancouver Island across years (Darling and McSweeney, 1985) but no interchange has yet been observed between feeding areas off California and those in Alaska (Baker *et al.*, 1986; Calambokidis *et al.*, 1989).

Although the humpback whales that summer along the California coast may represent a discrete feeding herd, they do not redistribute randomly between years within this region as evidenced by the decreasing proportion of matches with increasing distance between areas (Calambokidis *et al.*, 1989).

We estimate humpback whale population size with data gathered over a three-year period in the Gulf of the Farallones, California. Sampling effort in this region was thorough which resulted in a high proportion of the animals present being identified. We compare various mark-recapture estimates, consider some of the problems associated with these estimates, and compare the mark-recapture estimates with aerial line-transect estimates for the same region.

METHODS

Individual identification

The study area extended from the southern border of the Gulf of the Farallones National Marine Sanctuary (37°30'N) north to 38°30'N (off Bodega Bay, California) west to 122°30'W and included the Farallon Islands, Cordell Bank and Bodega Canyon (Fig. 1). Three primary vessels were used to photograph whales: a 44ft motor sailer (the *Noctilio*), a 19ft Boston Whaler and 14–16ft inflatable boats. Total vessel effort was 513 hours in 1986, 460 hours in 1987 and 484 hours in 1988. In 1986, vessel effort was conducted in a 7-week period from 23 July to 15 September; the 1987 surveys were conducted during two three-week sessions between 17 August–4 September and 25 September–17 October; the 1988 surveys were conducted in two three-week sessions between 19 August–5 September and 21 September–17 October, as well as a late season effort from 27 October to 2 November.

Whales were identified using photographs of the underside of the flukes. We used motor-advance 35mm cameras with lenses from 180mm f2.8 to 300mm f4.5 and Kodak Tri-X or Ilford HP-5 film black and white film pushed for ISO rating 1000 to 1600. A catalog of individual whales identified during the study was developed by comparing all photographs taken of individual whales.

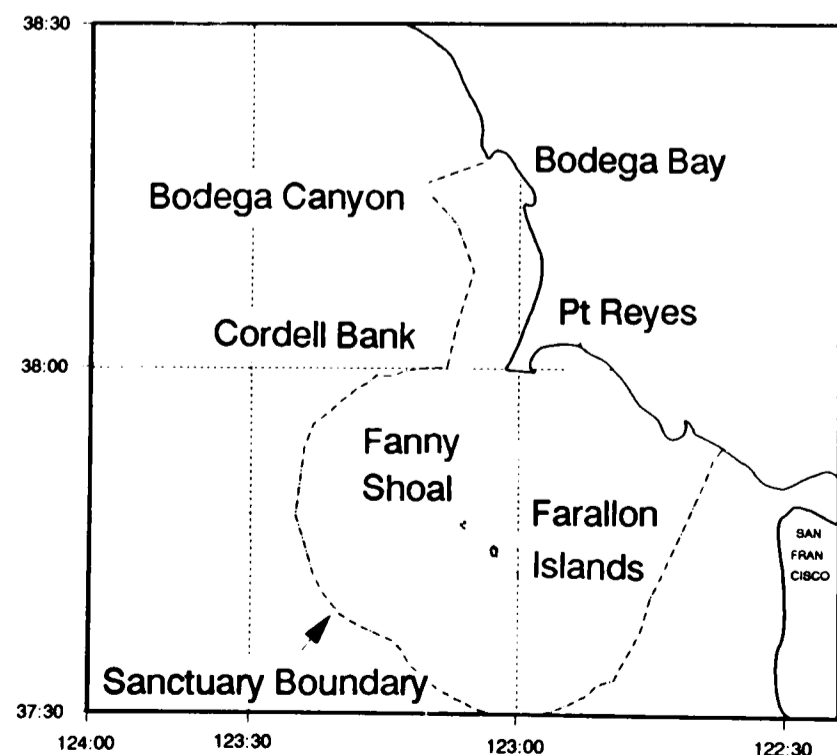

Fig. 1. Study area off central California showing the Gulf of the Farallones National Marine Sanctuary.

Mark-recapture estimates

Population estimates of humpback whales in the Gulf of the Farallones were derived with mark-recapture methods based on resighting rates of identified individuals. Estimates were made with the following procedures: (1) total individuals identified (number of unique individuals in a time period); (2) Chapman modification of the Petersen estimate (Seber, 1982, p.60; Chapman, 1951) for sampling without replacement (multiple captures of the same animal in the second sample were ignored); (3) Bailey modification of the Petersen estimate (Seber, 1982; Bailey, 1951) for sampling with replacement (an animal captured on several days in the second sample was counted each time (see Seber, 1982, pp.110–11)); (4) Jolly-Seber model (Seber, 1982, p. 219–20); and (5) rate of discovery (Darling and Morowitz, 1986).

Assumptions of the models are reported in Seber (1982) for the Petersen estimator (p. 59) and the Jolly-Seber method (p. 196).

Several sampling schemes were used for the mark-recapture calculations. Petersen estimates were computed using both within-year samples and between-year samples. Within-year samples were divided by date and alternatively by vessel and by region. The date used to divide samples was straightforward in 1987 and 1988 because the field season was divided into two sessions separated by a three-week interval; for 1986 a division date was chosen (19 August) that roughly divided the sample in half and occurred during a period of 7 days of no effort. Identifications made from the vessel having the largest sample were compared to identifications from all other vessels for each year. Identifications made in the southern portion of the study area were compared to those from the northern portion. The specific boundary of the separation was chosen as the 10 min latitude that separated the sample into the most similar sample sizes for each year. The Jolly-Seber estimate was made using each year as a sample.

Rate of discovery estimates were calculated using the generalized saturation curve suggested by Darling and Morowitz (1986), however, we used only daily totals of whales identified (whales identified multiple times in a single day were counted only once) instead of treating each identification as a sample. SYSTAT (Wilkinson, 1988) was used to fit the best parameters to the observed discovery rate. Rates of discovery were calculated for each year and for all three years combined. To help evaluate the observed discovery rate and the fitted curves, we also computed expected rates of discovery for the calculated saturation points, assuming whales were sampled randomly each day.

Estimates of emigration/mortality and immigration/nativity were made using the single-year Petersen estimates as the assumed number of animals present each year in the Gulf of the Farallones. Portions of this procedure are analogous to those used in the Manly-Parr method (Seber, 1982) except that the population for each year was obtained from the single-year Petersen estimates. This allows estimates of immigration and emigration between all sample years. The following formulas were used:

$$\begin{aligned}
 p_i &= n_i/N_i \\
 R_{i,i+1} &= m_{i+1}/(p_{i+1}p_i) \\
 NR_{i,i+1} &= N_i - R_{i,i+1} \\
 NEW_{i+1} &= N_{i+1} - R_{i,i+1}
 \end{aligned}$$

Where:

- P_i -proportion of year i population identified in year i
- n_i -number identified in year i
- m_{i+1} -number identified in year $i+1$ that had been identified in year i
- N_i -total estimated population in study area in year i (from Petersen within-year samples)
- $R_{i,i+1}$ -number present in both year i and year $i+1$
- $NR_{i,i+1}$ -number present in year i but not returning in year $i+1$
- NEW_{i+1} -number present in year $i+1$ that had not been present in year i

Data were tested for evidence of bias resulting from violations of mark-recapture assumptions. Rates at which identified humpback whales were resighted and their tenure (the number of days from the first to last sighting each season) were examined for 1986-8. Field data quantifying the rate of fluking by an individual whale was tested in 1987; these data were gathered during all photographic approaches to humpback whales where we photographed every fluke presented and endeavoured to stay with groups of whales until all in the group fluked and were photographed. We examined the number of fluke photographs per minute of effort (during approaches) among the individuals encountered on multiple occasions. Additionally, differences in the fluke display rate between individuals were examined in relation to the number of days a whale was seen through the study.

We compared a number of characteristics of fluke markings and photograph quality with the number of days that a whale was seen to evaluate the effects of the distinctiveness of marks on the resighting rate. If these qualities had no effect on our ability to identify an individual, there would be no increase in sighting frequency with distinctiveness. The following qualities of 141 whales identified in 1987 were scored from the catalog photographs (the best portrayal of an individual):

- Amount of white: 1 = 0-20% to 5 = 80 to 100% white
- Fluke trailing edge: 1 = no apparent fringing to 5 = definite distinctive gouges, bites or deep fringing
- Scars: 1 = no scars to 5 = distinctive or numerous scars
- Catalogue photo quality: 1 = poor to 5 = excellent focus, contrast and lighting
- Overall distinctness: 1 = indistinct to 5 = easy to recognize.

The number of days a whale was seen in 1987 was compared among the five possible scores (1-5) for each category above by analysis of variance (ANOVA).

Aerial line-transect surveys

Humpback whale numbers were also examined using line-transect population estimates from aerial survey data. Line-transect surveys were flown in a *Cessna 172* on 16 September 1986, 21 August 1987 and 26 September 1988; a line-transect calibration survey was flown on 22 August 1987. In 1987 and 1988, surveys were flown along latitude lines every four n.miles, in 1986 lines followed longitudes every 4 minutes (3.2n.miles). The area surveyed was smaller in 1986 than in 1987-8 (Fig. 2) but nevertheless covered the region where humpback whales had been observed in previous vessel and aerial (non-transect)

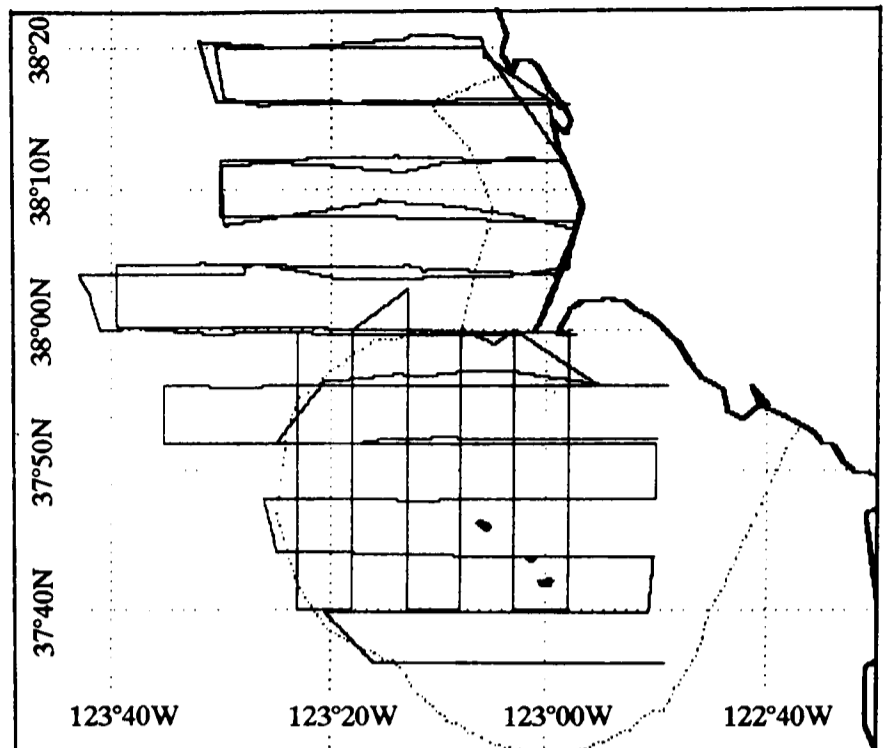

Fig. 2. Tracklines for aerial line-transect surveys in 1986-8. The 1986 survey is represented by north to south transect lines. The 1987 and 1988 surveys covered similar areas with the exception of the southern portion of the study which was not surveyed in 1988 due to heavy fog. Dotted lines shows sanctuary boundary.

surveys. All surveys were conducted under good or excellent sighting conditions with the exception of the southern portion of the 1988 survey which was aborted due to fog.

Distances to humpback whales from the survey line were measured from aircraft altitude and downward angle to the sighting (measured with an inclinometer) as the aircraft passed abeam of the sighting location. All humpback whale sightings (1986-8) from aerial surveys with distance measurements were used to develop a Fourier Series model of the sighting probability based on distance from the transect line (Fig. 3) as described in Burnham, Anderson and Laake (1980). Methods used for density calculations are described in Burnham *et al.*, (1980). Variances for density estimates were based on the assumption of a binomial distribution for n (Burnham *et al.*, 1980).

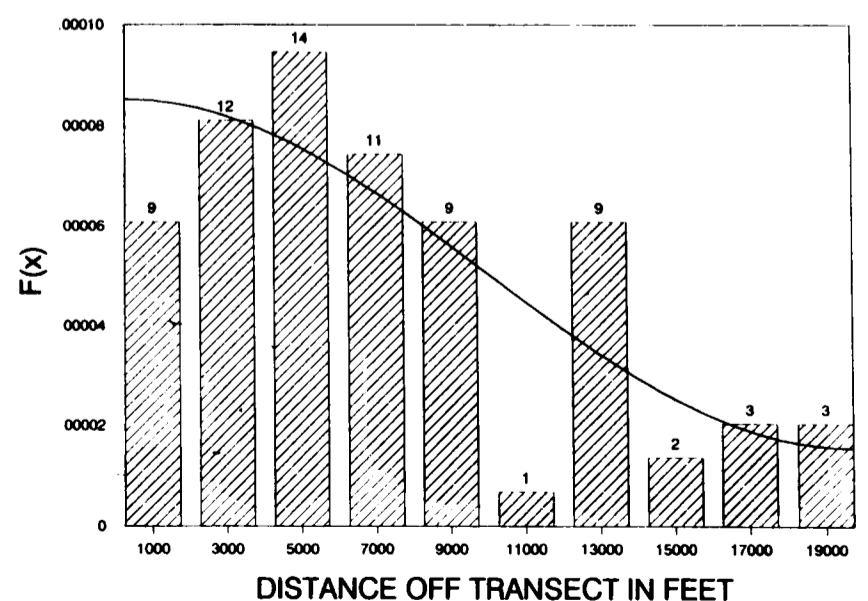

Fig. 3. Fourier series sighting probability curve from aerial line-transect surveys in 1986-8. Bars show the observed distribution of sightings based on distance off transect. The number of sightings is indicated above bars.

We calculated a crude correction factor to estimate the proportion of whales that may have been missed on the transect line because they were underwater. Replicate survey lines and sightings of whales made from adjacent transect lines were used to identify 24 groups of humpback whales known to be within 10,000ft of the transect line (based on a sighting from a different line). Using the sighting curve and the distance off transect, we predicted 18.7 of these 24 groups should have been seen (if whales were at the surface). Only 7 groups (37% of the expected) were seen. The remainder of those expected were presumably out of sight underwater because the sighting function already accounted for the decreasing sighting efficiency due to distance off transect. We therefore used this figure (0.37) to correct for animals missed even if they were on the transect line. This correction is similar to the proportion of time humpback whales spent at the surface (39%) in the Gulf of the Farallones determined from vessel-based behavior observations in 1988 ($n=184$, T. Kieckhefer, unpubl. data).

RESULTS

Population estimates using individual identification

A minimum estimate of population size is the number of individuals identified each year (Table 1). Each year an increasing proportion of the whales seen through the season had been already identified that year (Fig. 4). Clearly, the number identified is an underestimate because some individuals would have escaped detection. Estimates based on rate of discovery curves were similar to the number of whales identified in 1986 and 1987. In 1988 the estimate was higher than the number of whales identified (Table 2). This is consistent with our failure to identify as high a proportion of the population in 1988 compared to 1986 and 1987, indicated by the fewer times each individual was resighted and the steeper slope of the observed rate of

discovery. Observed rates of discovery differed slightly from those expected if the population had been sampled randomly (Fig. 4).

Table 1

Individual humpback whales identified in the Gulf of the Farallones from 1986 to 1988.

Year	Identified		Times seen		Matches by year		
	Number	Unique	mean	SD	86	87	88
1986	466	90	5.2	4.0		56	48
1987	793	141	5.6	4.5		-	75
1988	398	135	2.9	2.1			-
1986-8	1,658	225					

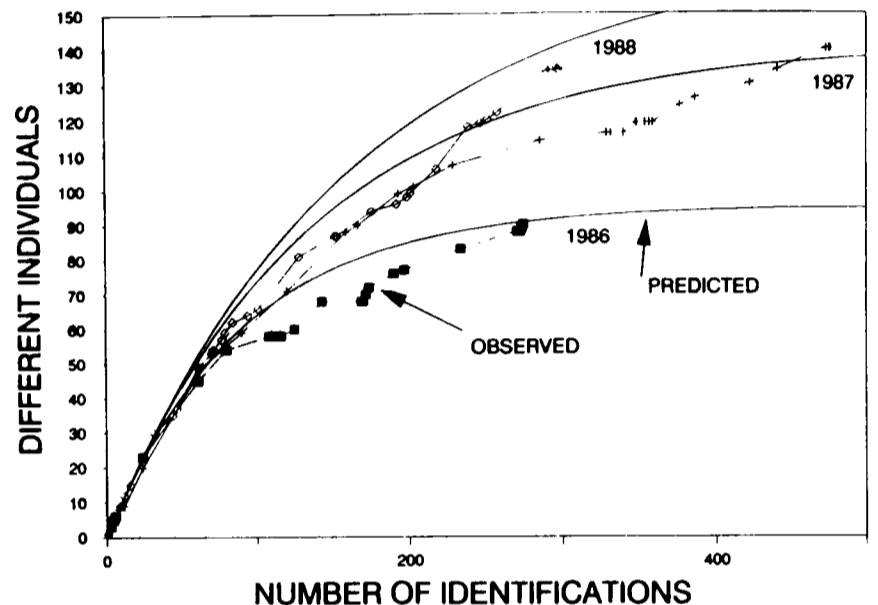

Fig. 4. Rate at which new humpback whales were identified (rate of discovery) in relation to total whales identified each year. Predicted curve shows expected rate of discovery if the estimated population were sampled randomly. Each point is a single day. Multiple sightings of the same whale in a day are counted once.

Table 2

Population estimates based on mark-recapture estimates. All n_1 and n_2 values refer to the number identified in the first and second sample periods. For between-year estimates, values are listed under the second year with n_1 referring to the number identified in the previous year.

Samples/method	1986					1987					1988					All yrs
	n_1	n_2	m_2	Est	Var	n_1	n_2	m_2	Est	Var	n_1	n_2	m_2	Est	Var	
<i>Within-year Petersen without replacement</i>																
Seasonal ¹	58	75	42	103	29	120	75	54	166	75	38	135	24	211	507	
Vessel ²	75	81	65	93	3	109	125	93	146	8	109	103	62	181	87	
Location ³	60	83	52	96	8	116	86	61	163	58	113	79	42	211	294	
<i>Within-year Petersen with replacement</i>																
Seasonal	58	160	94	99	41	120	128	95	162	69	38	262	64	157	270	
Vessel	75	170	148	84	3	109	286	236	127	5	109	151	103	156	52	
Location	60	171	105	95	17	116	144	106	149	24	113	89	54	192	204	
<i>Between-year Petersen without replacement</i>																
						90	141	56	226	198	141	135	75	253	172	
<i>Between-year Petersen with replacement</i>																
						90	476	229	188	78	141	296	179	233	118	
Total IDs				90					141					135	225	
Rate of discovery				95					140					167	261	
Jolly-Seber									188	160						

¹ Seasonal division corresponds to period with 1-3 weeks of no effort; 29 August for 1986 and 15 September for 1987 and 1988.

² Vessel effort included 3 vessels each year, sample 1 was chosen as vessel with greatest number of IDs, sample 2 based on all other vessels.

³ Location samples were selected using the 10' latitude division that provided the most similar number of individuals identified in each area; 37°5N in 1986, 38°00'N in 1987, and 38°10'N in 1988.

Population sizes calculated with Petersen estimates using within-year samples divided by date, vessel, or region were higher than the number of individuals identified (Table 2). Estimates using the Chapman modification for sampling without replacement and ignoring multiple recaptures of the same individual were lower than those calculated with the Bailey modification for sampling with replacement (allowing multiple sampling and recaptures of individuals in the second time period). This difference was largest in 1988. Estimates based on sightings divided by date were the highest; estimates based on samples divided by vessel yielded the lowest estimates and may be the most biased because different vessels often worked in the same area and would be more likely to sample the same whales.

Estimates based on samples taken in different years were generally higher than estimates based on within-year samples (Table 2). Even the total number of individuals identified in two years was higher than the estimates from within-year mark-recapture calculations. Using consecutive years as samples, the Petersen estimates ranged from 188 to 253 depending on the year and whether the sampling was with or without replacement. Sampling with replacement again lowered estimates and variances compared to sampling without replacement for the same periods. The between-year estimates exceeded the number of individuals identified in the two years by, at most, 30%.

The Jolly-Seber estimate was the only open-population model employed. Because three years were available, it yielded an estimate for the middle year (1987) only. This estimate (188, Var.=160) was higher than the within-year Petersen estimate for 1987 and lower than the between-year Petersen estimate (without replacement). With the three years of data this method also provided an estimate of survival (which would include permanent emigration) of 0.83 between the first and second year.

Rate of discovery calculations among all three years (Fig. 5) yielded the highest estimates of population size (261). Fig. 5 shows clear changes in the rate of discovery curve with each new season as a result of an apparent change in the individuals returning from year to year. The steeper slope at the start of each year is consistent with either immigration/natality or more complete mixing of whales between years. The predicted curve shows that a different rate of discovery would be expected if a population of 261 were being sampled randomly.

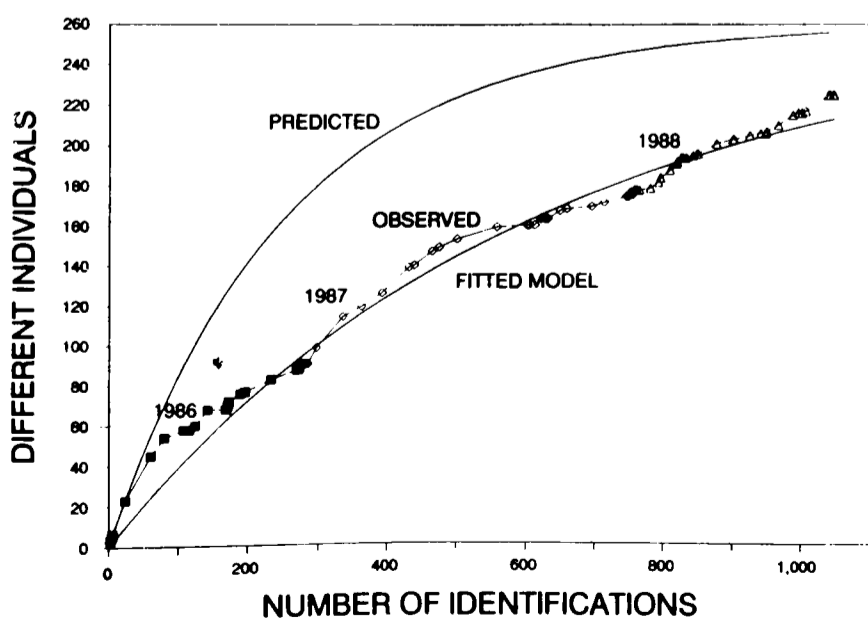

Fig. 5. Rate of discovery of humpback whales across all three years. The modeled curve (based on the rate of discovery calculation) and the predicted curve (if the estimated population were sampled randomly) are shown.

Population closure

Calculations of immigration and emigration indicated the population was not closed between years (Table 3). For 1986 and 1987, 22% and 17% of the whales present each year were estimated not to have returned the following year. Conversely, 54% and 35% of the whales identified in 1987 and 1988 were estimated to have not been present the previous year. These calculations are based on the assumption that the within-year Petersen estimates reflected the true abundance of whales in the study area each year. These changes exceed effects of mortality and natality and therefore reflect substantial immigration and emigration between years to the Gulf of the Farallones feeding group. The higher immigration than emigration rate reflects the increasing estimates of abundance for each of the three years.

Table 3

The estimated number of whales that returned and did not return to the Gulf of the Farallones across years assuming within-year Petersen estimates accurately reflected annual abundance. See Methods for details of calculations. Numbers of whales identified each year and estimated populations sizes are shown in Table 2 under within-year Petersen estimates (without replacement) based on seasonal samples.

	$R_{1,2}$	$NR_{1,2}$	$New_{1,2}$	$\%IM_2$	$\%EM_1$
1986-7	76	27	90	54	26
1987-8	138	28	73	35	17

$R_{1,2}$ = Returning between years; $\%IM_2$ = %new of year 2;
 $NR_{1,2}$ = Not returning; $\%EM_1$ = % of year 1 not returning
 $New_{1,2}$ = New, not seen the previous year;

Probability of capture

In addition to violations of population closure mentioned above, we found other violations of mark-recapture assumptions, especially the assumptions that all individuals have an equal probability of being identified (captured). Resighting rates and tenure for whales were different for whales seen across years compared with whales seen in only one year (Fig. 6). The number of times and days a whale was seen in each of the three years was significantly different among those whales that had been identified in one, two, or all three years (ANOVA, $p < 0.05$ for all six tests). In all cases, whales seen in only one year were seen less often that year than whales that had been seen in other years; whales seen in all three years were seen most often each year. A related pattern was observed with tenure (the number of days from the first to last sighting of an individual each year); tenure in 1987 and 1988 was significantly different depending on other years seen (ANOVA, $p < 0.05$ and $p < 0.001$, respectively), with whales that had been seen in all three years seen an average of 15 days longer than whales seen in one year only. These data indicate that a subgroup of whales appeared to return annually and remain longer in the Gulf of the Farallones than other whales.

The number of days a whale was seen in 1987 varied significantly by the degree of scarring on the flukes (ANOVA, $n=141$, $p < 0.05$) with the most heavily scarred whales being seen most often (Fig. 7, Table 4). Number of days seen did not vary significantly (ANOVA, $p > 0.05$) by three other measures of fluke distinctiveness (color, edge and overall distinctiveness). As expected, catalog

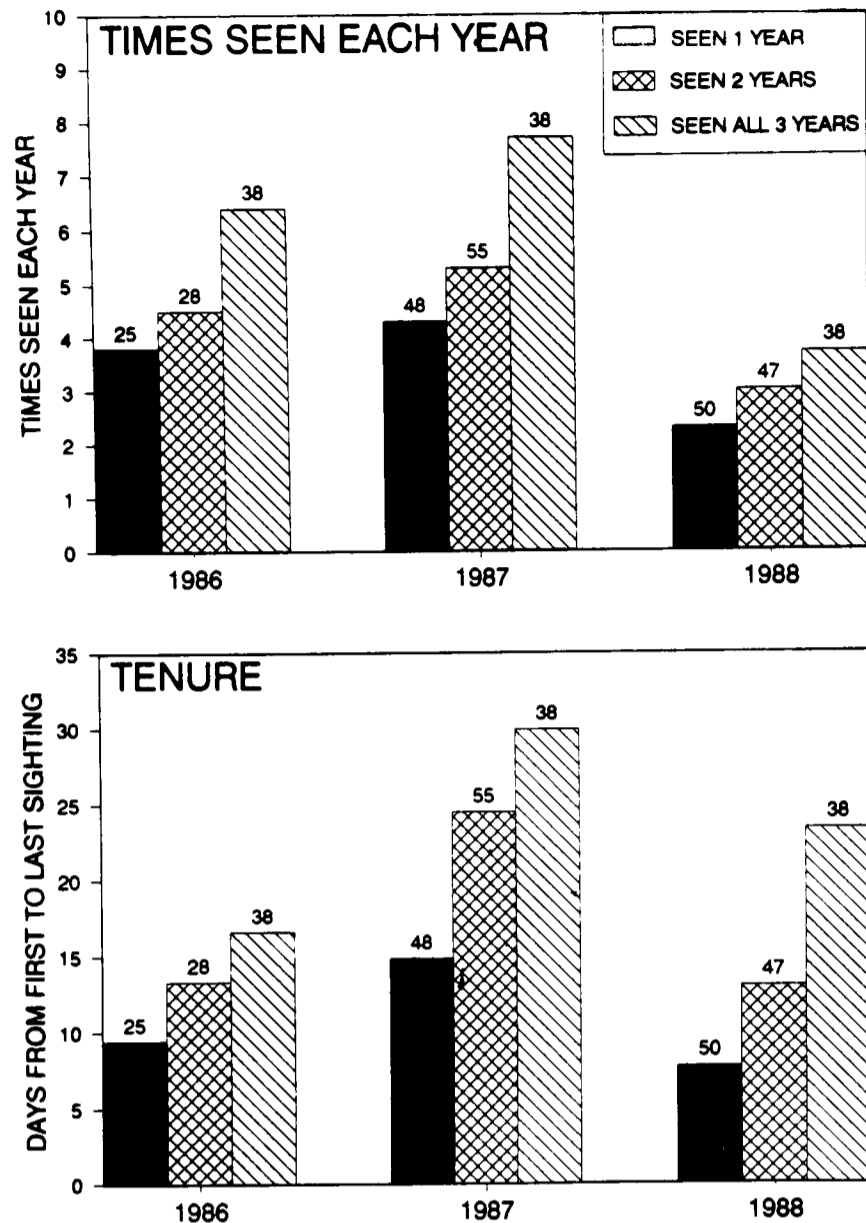

Fig. 6. Number of times individuals were seen each year and tenure (days elapsed from first to last sighting each year) for whales identified in the Gulf of the Farallones. The number of whales is indicated above bars.

photograph quality tended to increase with number of times an animal was seen and therefore the greater the chance of a good portrait.

Some consistent differences in the behavior of individual whales were found that would make them comparatively more or less 'catchable' with photo-identification. The number of fluke photographs per minute of effort (during approaches) varied significantly among the individuals encountered on multiple occasions (ANOVA, $p < 0.05$). Individuals also showed consistent differences in the rate of fluke display expressed as the number of times flukes were photographed in an encounter as a percent (arcsine transformed) of the number of fluke photographs of the

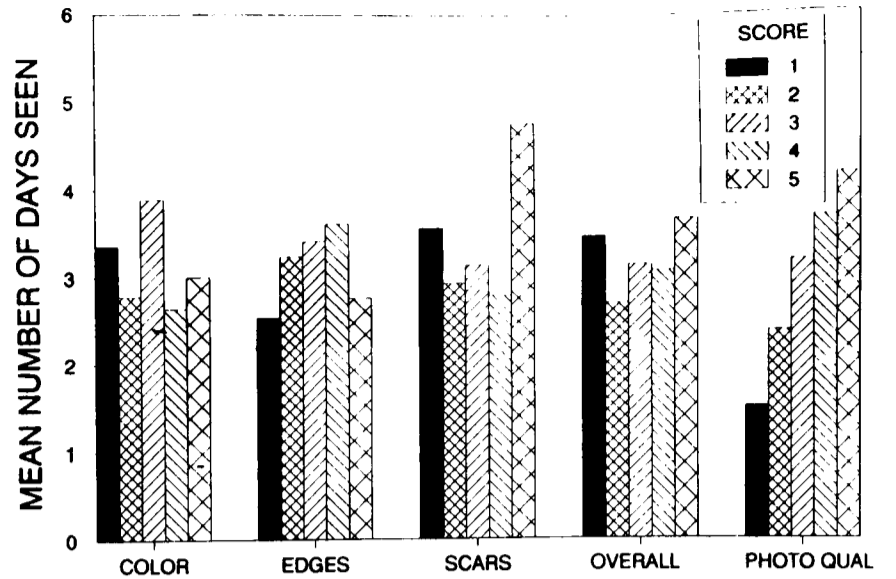

Fig. 7. The mean number of days humpback whales were seen by scored fluke characteristics and photograph quality (scored 1–5, see methods for description) of 141 humpback whales identified in 1987 in the Gulf of the Farallones.

whale that fluked most often in the group accompanying the individual (ANOVA, $p < 0.05$). These differences in fluke display rate indicated some whales are consistently photographed more or less often than other whales.

These differences in the fluke display rate between individuals, however, did not appear to affect the number of days a whale was seen through the study. There was no correlation between the number of days an individual was photographed and either the average fluke photographs per minute of that whale or the fluke display rate ($n = 141$, $p > 0.05$). Different fluking rates by individuals illustrate the potential for uneven 'catchability' of individual humpback whales, but this did not bias the recapture rate. The apparent low bias in photographic sampling in this study may reflect the consistent effort to photograph all whales in a group.

Population estimates from aerial line-transects surveys

The line-transect surveys conducted once each year in the Gulf of the Farallones yielded estimates of humpback whale abundance on a single day (Table 5). The yearly estimates, uncorrected for animals missed because they were not at the surface, were about five times lower than those based on individual identifications. When corrected for whales underwater, the line-transect estimates were still consistently lower than those based on individual identification; within-year mark-recapture estimates were about 50% higher than the aerial line-transect estimates in all three years. The area covered by the line-transect surveys was smaller in 1986 than in 1987 and 1988 but

Table 4

Number of days humpback whales were seen in 1987 by degree of distinctiveness in several categories (see Methods for explanation of scoring).

	1			2			3			4			5		
	n	mean	SD	n	mean	SD	n	mean	SD	n	mean	SD	n	mean	SD
Color	70	3.4	2.4	23	2.8	1.6	18	3.9	1.8	11	2.6	1.6	19	3.0	2.2
Edges	15	2.5	2.0	47	3.2	2.2	47	3.4	2.1	20	3.6	2.5	12	2.8	1.9
Scars	13	3.5	2.5	35	2.9	2.2	34	3.1	2.0	40	2.8	1.5	19	4.7	2.7
Overall	9	3.4	2.2	19	2.7	2.5	24	3.1	2.0	44	3.1	2.0	45	3.6	2.3
Photo quality	6	1.5	0.8	24	2.4	1.8	52	3.2	2.0	48	3.7	2.3	11	4.2	2.2

Table 5

Estimates of humpback whale numbers from aerial line-transect surveys. Group size and $f(0)$ calculated from data for all three years.

Date	Groups seen ¹	Transect km	$f(0)$	Density per km ²	SE density	Area ² surv.	Est. groups	Group size	Proportion at surface ³	Estimated number
16 Sept 86	10	222	0.28	0.0062	0.0020	1.646	10.2	2.2	0.37	60
21 Aug 87	11	624	0.28	0.0033	0.00089	4.623	15.2	2.2	0.37	90
26 Sept 88	46	350	0.28	0.0047	0.0014	3.929	18.5	2.2	0.37	109

¹ Number seen likely includes some duplicate animals seen from adjacent survey lines.

² Because study area was surveyed systematically, only area (km²) covered by survey lines is used, except for 26 September 1988 where portion of study area where whales were seen in previous day (but could not be surveyed due to fog) is included.

³ See Methods for calculation.

nevertheless covered the region where humpback whales were being seen from vessel and aerial observations prior to the survey. Additional humpback whales were likely present in areas peripheral to those we surveyed and these individuals would have been included in the mark-recapture estimates if they intermixed and were a part of the same feeding aggregation.

DISCUSSION

The principal problems in our mark-recapture estimates, especially for those based on between-year sampling, are: (1) the lack of a defined, closed population being sampled; and (2) our failure to gather a random sample.

Humpback whales occurred in other areas along the California coast concurrent to our work in the Gulf of the Farallones; there was interchange between these areas that varied as a function of the distance from the region (Calambokidis *et al.*, 1989). Defining the discrete population being sampled in this case is problematic. If we assume we are sampling only the feeding aggregation that uses the Gulf of the Farallones then we have violated the assumption of a closed population because of the mixing (immigration and emigration) with other feeding areas along the California coast. This violation results in an overestimate of the animals in the Gulf of the Farallones. By defining the population sampled as the entire humpback whale aggregation feeding along the California coast, violations of the closed population assumption are reduced but unequal capture probability becomes a problem because: (1) we did not sample all areas of the California coast randomly; and (2) whales do not redistribute randomly between samples (years) to different locations. Sampling at one location increases the probability that animals marked in the first sample will be recaptured in the second sample, resulting in an underestimate of the number of animals present along the entire California coast. These problems are consistent with the higher estimates we obtained from between-year samples compared with within-year samples because the between-year samples were in essence taken from a larger population, albeit in a biased manner.

Hammond (1986) considers accurate definition of the population sampled as an important concern with estimation of cetacean populations. This problem is not unique to our study; between-year estimates of humpback whales on feeding grounds have been reported for West Greenland (Perkins *et al.*, 1984, 1985), Newfoundland-Labrador (Whitehead, 1982; Whitehead

and Glass, 1985) and the Gulf of Maine (Katona and Beard, 1990). Humpback whales tend to return to these broad regions consistently (Whitehead, 1982; Balcomb, 1984; Perkins *et al.*, 1985; Katona and Beard, 1990), therefore minimizing the violation of the closed population assumption. Whitehead, Silver and Harcourt (1982) documented the problem of incomplete mixing between years for animals at different sites in the Newfoundland-Labrador region and Hammond (1985; 1986) reported evidence of incomplete mixing off West Greenland. Perkins *et al.* (1984; 1985) considered incomplete mixing to be less of a problem because their annual samples off West Greenland covered a large portion of the region, hopefully reducing the bias caused by incomplete mixing between years. Unless all areas of a region are sampled randomly or sampled in proportion to their contribution to the overall humpback whale population, however, the resulting estimates will still be biased.

Differences in the behavior of humpback whales, that apparently caused unequal catch probability in our samples, have been reported in other cetacean studies. The occurrence of subgroups of whales that tend to be more resident or transient has been reported similarly for southern right whales (Whitehead, Payne and Payne, 1986). Segregation by size class on feeding grounds has been reported for bowhead whales (Cubbage and Calambokidis, 1987) and differential arrival and departure times for humpback whales on feeding grounds by size and reproductive condition has been seen (Pike, 1962; Dawbin, 1966; Whitehead *et al.*, 1982). Whitehead *et al.* (1982) reported that humpback whales with signs of killer whale tooth marks on their flukes tended to arrive later on Newfoundland feeding grounds than those without such scars. Differences in fluking behavior by age class, with calves fluking less often, have been reported by Perkins *et al.* (1985) and Kaufman, Smultea and Forestell (1987).

Two-sample Petersen estimates using data from photo-identified whales can be conducted either with or without replacement. Our estimates were consistently lower when the sampling was with replacement, probably because whales seen (captured) once were more likely to be seen again within the sample period than whales that had not been seen. This unequal capture probability would bias estimates downward. Hammond (1986) recommended use of the Bailey modification of the Petersen estimate for estimates based on photo-identification because it was appropriate for sampling with replacement. Most estimates of humpback whale populations using Petersen estimates, however, have been conducted as if the

sampling is without replacement, i.e. resightings of the same individuals within a sample period are ignored. Ignoring resightings is the same as sampling without replacement because it is mathematically equivalent to removing these individuals from the population for the remainder of the sample period. Sampling without replacement is advisable because it appears to be less biased by the unequal capture probability created by repeated sightings of the same individual. The Chapman modification of the Petersen estimate, recommended for sampling without replacement (Seber, 1982), is therefore the more appropriate method for use with photo-identification data.

Whale populations have been estimated extensively with mark-recapture methods in recent years and although most researchers recognize the shortcomings of these techniques, there is little information to quantify the biases. Despite the comprehensive photo-identification effort in our research, our population estimates varied depending on year sampled, estimate procedure, and scheme used to divide samples. A more accurate understanding of stock structure and methods to sample the population randomly is needed because results can be biased substantially. Mark-recapture estimates, especially when employed at a single area across years, should be used in conjunction with other techniques or with improved knowledge of stock structure and other sources of bias.

ACKNOWLEDGEMENTS

The research was funded by the Gulf of the Farallones National Marine Sanctuary, National Oceanic and Atmospheric Administration. Nancy Stone and Miles Croom of the sanctuary and Gary Fellers of the National Park Service provided advice and support for the study. Dan Bockus, Stephanie Bartok, Diane Claridge, Nicola Wadsworth, Heidi Rodingier, Greg Falxa, Gary Falxa, C. Scott Baker, Luke Bloedel, Jeanette Smith, Gary Davis, J. Conover, Lea Mitchell, Stuart Goldman and Tom Ford assisted in the field. Tom Kieckhefer of the Moss Landing Marine Lab and Chris Tanner shared sighting information; personnel of the Point Reyes Bird Observatory provided reports of sightings and weather conditions. Farallon Research Associates, under a subcontract, provided information on sightings and photographs taken from Oceanic Society nature trips, especially Connie Ewald, Izzy Szczepaniak, Steve Cooper and Marc Webber. Nancy Black of Moss Landing Marine Lab also provided photographs. We thank *Achilles Inflatable Craft*. N. Haenel, Kelly Balcomb, Diane Claridge, Elizabeth McManus, Jennifer Horn, Jeff McGowan, Payton Carling, and Donald Smith assisted in photographic developing and matching. Paul Siri, Deke Nelson, and Kitty Brown of the Bodega Marine Lab provided housing and supported a survey using the *Avant-Garde*. Elizabeth McManus assisted in literature search. Joseph Buchanan, John Francis, Carole Carlson and T.J. Quinn II reviewed the draft manuscript. We thank these people and organisations.

REFERENCES

- Alvarez, C., Aguayo, A., Rueda, R. and Urbán, J. 1990. Estimates of humpback whale stock size along the mainland coast of the Mexican Pacific. Paper SC/A88/ID27 (published in this volume).
- Bailey, N.T.J. 1951. On estimating the size of mobile populations from recapture data. *Biometrika* 38: 293-306.
- Baker, C.S. and Herman, L.M. 1987. Alternative population estimates of humpback whales (*Megaptera novaeangliae*) in Hawaiian waters. *Can. J. Zool.* 65: 2818-21.
- Baker, C.S., Herman, L.M., Perry, A., Lawton, W.S., Straley, J.M., Wolman, A.M., Kaufman, G.D., Winn, H.E., Hall, J.D., Reinke, J.M. and Ostman, J. 1986. Migratory movement and population structure of humpback whales (*Megaptera novaeangliae*) in the central and eastern North Pacific. *Mar. Ecol. Progr. Ser.* 31: 105-19.
- Balcomb, K.C. 1984. The stock(s) of humpback whales in the North Atlantic Ocean. *Rep. int. Whal. Commn* 34: 141-3.
- Balcomb, K.C. and Breiwick, J.M. 1984. Mark-recapture analysis of western North Atlantic humpback whales using fluke photographs. *Rep. int. Whal. Commn* 34: 141.
- Balcomb, K.C., Katona, S.K. and Hammond, P.S. 1986. Population estimates for the North Atlantic humpback whale using capture-recapture methods on photo-identified whales. *Rep. int. Whal. Commn* 36: 110.
- Burnham, K.P., Anderson, D.R. and Laake, J.L. 1980. Estimation of density from line transect sampling of biological populations. *Wildl. Monogr.* 72: 1-202.
- Calambokidis, J., Steiger, G.H., Cabbage, J.C., Balcomb, K.C. and Bloedel, P. 1989. Biology of humpback whales in the Gulf of the Farallones. Report to the Gulf of the Farallones National Marine Sanctuary, NOAA, San Francisco, California (unpublished). 93pp.
- Chapman, D.G. 1951. Some properties of the hypergeometric distribution with applications to zoological censuses. *Univ. Calif. Public. Stat.* 1: 131-60.
- Cabbage, J.C. and Calambokidis, J. 1986. Size-class segregation of bowhead whales discerned through aerial stereophotogrammetry. *Mar. Mamm. Sci.* 3: 179-85.
- Darling, J.D. and Jurasz, C.M. 1983. Migratory destinations of North Pacific humpback whales (*Megaptera novaeangliae*). In: R. Payne (ed.) *Communication and Behavior of Whales*. AAAS Selected Symposia Series, Washington, D.C.
- Darling, J.D. and McSweeney, D.J. 1985. Observations on the migrations of North Pacific humpback whales (*Megaptera novaeangliae*). *Can. J. Zool.* 63: 308-14.
- Darling, J.D. and Morowitz, H. 1986. Census of 'Hawaiian' humpback whales (*Megaptera novaeangliae*) by individual identification. *Can. J. Zool.* 64: 105-11.
- Dawbin, W.H. 1966. The seasonal migratory cycle of humpback whales. pp. 145-70. In: K.S. Norris (ed.) *Whales, Dolphins and Porpoises*. University of California Press, Berkeley, California.
- Hammond, P.S. 1985. An analysis of the West Greenland humpback capture-recapture data using log-linear models and the GLIM computer package. Paper SC/37/PS30 presented to the IWC Scientific Committee, June 1985 (unpublished). 4pp.
- Hammond, P.S. 1986. Estimating the size of naturally marked whale populations using capture-recapture techniques. *Rep. int. Whal. Commn* (special issue 8): 253-82.
- Hammond, P.S. and Larsen, F. 1985. Some notes on estimating populations size of West Greenland humpbacks using mark-recapture. *Rep. int. Whal. Commn* 35: 129.
- Katona, S.K. and Beard, J.A. 1990. Population size, migrations and substock structure of the humpback whale (*Megaptera novaeangliae*) in the western North Atlantic Ocean. Paper SC/A88/ID2 (published in this volume).
- Kaufman, G.D., Smultea, M.A. and Forestell, P. 1987. Use of lateral body pigmentation patterns for photographic identification of east Australian (Area V) humpback whales. *Cetus* 7: 5-13.
- Perkins, J.S., Balcomb III, K.C., Nichols Jr., G. and DeAvilla, M. 1984. Abundance and distribution of humpback whales (*Megaptera novaeangliae*) in West Greenland waters. *Can. J. Fish. Aquat. Sci.* 41: 533-6.
- Perkins, J.S., Balcomb III, K.C., Nichols Jr., G., Hall, A.T., Smultea, M. and Thumser, N. 1985. Status of the West Greenland humpback whale feeding aggregation, 1981-83. *Rep. int. Whal. Commn* 35: 379-83.
- Perkins, J.S. and Whitehead, H. 1977. Observations on three species of baleen whales off northern Newfoundland and adjacent waters. *J. Fish. Res. Bd Can.* 34: 1436-40.
- Pike, G.C. 1962. Canadian whaling off British Columbia, and progress on research, 1948 to 1959. Report to the Fish. Res. Board Can., Nanaimo, British Columbia (unpublished).
- Seber, G.A.F. 1982. *The Estimation of Animal Abundance and Related Parameters*. Second Edition, MacMillan Publ. Co, New York, NY. 654pp.

- Urbán, J., Balcomb, K.C., Alvarez, C., Bloedel, P., Cabbage, J.C., Calambokidis, J., Steiger, G.H. and Aguayo, A. 1987. Photo-identification matches of humpback whales (*Megaptera novaeangliae*) between Mexico and central California. Presented to the Seventh Conference on the Biology of Marine Mammals, Miami, Florida (unpublished).
- von Ziegeler, O. and Matkin, C.O. 1986. Humpback whales in Prince William Sound in 1985: a contract report. Contract No. 41USC252, Natl. Mar. Fish. Serv., Natl. Mar. Mamm. Lab., Seattle, Washington (unpublished).
- Whitehead, H. 1982. Populations of humpback whales in the northwest Atlantic. *Rep. int. Whal. Commn* 32: 345-53.
- Whitehead, H., Chu, K., Perkins, J., Bryant, P. and Nichols, G. 1983. Population size, stock identity, and distribution of the humpback whales off West Greenland-Summer 1981. *Rep. int. Whal. Commn* 33: 497-501.
- Whitehead, H. and Glass, C. 1985. The significance of the Southeast Shoal of the Grand Bank to humpback whales and other cetacean species. *Can. J. Zool.* 63: 2617-25.
- Whitehead, H., Payne, R. and Payne, M. 1986. Population estimate of the right whales off Peninsula Valdes, Argentina, 1971-76. *Rep. int. Whal. Commn* (special issue 10): 169-71.
- Whitehead, H., Silver, R. and Harcourt, P. 1982. The migration of humpback whales along the northeast coast of Newfoundland. *Can. J. Zool.* 60: 2173-9.
- Wilkinson, L. 1988. *SYSTAT: The System for Statistics*. SYSTAT, Inc., Evanston, Illinois. 822pp.

Photographic Identification of the Blue Whale (*Balaenoptera musculus*) in the Gulf of St. Lawrence, Canada

Richard Sears, J. Michael Williamson, Frederick W. Wenzel, Martine Bérubé,
Diane Gendron and Peter Jones

Mingan Island Cetacean Study, 285 Green Street, St. Lambert, QC, Canada

ABSTRACT

We present here the first long term study of the blue whale, based on the photo-identification of individuals. The study took place in the Gulf of St. Lawrence, Canada and consisted of 672 days of observation during 36 months from 1979 to 1988. Observations were carried out using small boats and amphibious aircraft from the Saguenay River to the Strait of Belle Isle; with the primary study area being that of the Mingan Island region. We have identified 203 individual blue whales through photographs of the characteristic mottled pigmentation found on the back and flanks. Blue whales were found in the Gulf of St. Lawrence from January through November with greatest numbers from August to October, particularly along the north shore of the Gulf between the Saguenay River and the Strait of Belle Isle. To facilitate matching, the mottled pigmentation pattern was classified into three categories: balanced, merging and tiered. These categories were qualified further by grading the density and tone of the mottling into four types. Of the 203 photo-identified blue whales, 42% were sighted in more than one year and 55% of these ranged widely along the north shore of the Gulf from April to November. Blue whales rarely resided for more than 3 to 10 days in any given area and four individuals travelled 300–400 miles in 14 days along the Quebec North Shore during the feeding season.

INTRODUCTION

During the past 15–20 years, considerable effort has been directed towards the study of living marine mammals in their environment. Accurate identifications can be achieved through photographs of scars, deformities, variation in dorsal fin shape and, most effectively, pigmentation patterns. The photo-identification of individuals has become the backbone of many long term research projects and has enabled researchers to compile accurate data on, for example, population size, distribution and migration of several species (see IWC, 1990).

Although little is known of the present day population size and distribution of blue whales in the North Atlantic, its historic summer distribution was well known to whalers as ranging from the Gulf of St. Lawrence and Newfoundland to Davis Strait and as far as Iceland in the western North Atlantic (Ingebrigtsen, 1929; Jonsgård, 1966). In the eastern North Atlantic, blue whales have been found from Spitsbergen in the North during the summer, to the northwestern coast of Africa at the level of Cape Blanco and the Cape Verde Islands during February and March (Ingebrigtsen, 1929).

Blue whales have been reported to be increasing off the west coast of Iceland (Sigurjónsson and Gunnlaugsson, 1990). Apart from these, the few recent confirmed sightings of blue whales in the western North Atlantic outside of the Gulf of St. Lawrence have been on the Nova Scotian shelf (Sutcliffe and Brodie, 1977; CeTAP, 1982), the southern coast of Newfoundland (Lien, Stenson, Booth and Sears, 1987) and the first three ever documented in the Gulf of Maine (Wenzel, Mattila and Clapham, 1988).

Large scale whaling for blue whales in the eastern North Atlantic began in 1868 off Spitsbergen, eastern Iceland and Finnmark, and peaked in 1904 (Jonsgård, 1955). By 1915 whaling for this species had all but ceased in these areas, as the catch had decreased to economically insignificant numbers (Ingebrigtsen, 1929). From 1903 to 1915 the total number of blue whales caught off Newfoundland and in

adjacent waters was approximately 1,170 (Sergeant, 1966). A whaling operation based in Sept-Iles on the Quebec North Shore from 1911–15 took both fin and blue whales. The total catch was of 392 animals (Mitchell, 1975), predominantly fin whales; approximately one-third may have been of blue whales. Whaling of this species in eastern Canadian waters ended in 1951, and in the entire North Atlantic by 1955 (Jonsgård, 1955). It can be assumed that well over 1,500 blue whales have been harvested in eastern Canadian waters. Mitchell (1974a) stated that the blue whale population in the western North Atlantic may number only in the low hundreds.

One known cause of mortality for this species in the Gulf of St. Lawrence, since the cessation of whaling, is late winter – early spring entrapment caused by movements of current or wind blown ice. These entrapment-strandings occur most regularly on the southwest coast of Newfoundland. Ice entrapment reports date as far back as 1868 when five blue whales were found stranded on the southwest corner of Newfoundland (Sergeant, 1982). Since 1958, as many as 35 animals stranded due to ice off southwestern Newfoundland and in the Gulf of St. Lawrence; of those, at least 26 died, 24 since 1976 (Mitchell, 1974b; 1975; 1976; 1977; 1978; 1979; 1980; 1981 and 1982; Sergeant, 1966; Lien *et al.*, 1987).

Further probable sources of mortality include collisions with large vessels and entanglements in fishing gear.

MATERIALS AND METHODS

The present study is based on the photo-identification of individuals. This requires clear, high quality photographs. Most (93.3%) of the identification photographs from the Gulf of St. Lawrence were taken by members of our research team and the remainder by researchers involved in the study of other marine mammals. The primary study area was the Mingan Island Region (50°15'N, 64°10'W). Observations along the north shore of the Gulf of St. Lawrence – from the Saguenay River (48°10'N, 69°45'W) to the Strait of Belle Isle (51°57'N, 55°25'W) – included a

total of 3,417.4 hrs of vessel surveys (597 days) between 1979 and 1988 and 408.7hrs (75 days) of aerial surveys between 1979 and 1985. Prior to 1986, vessel surveys were carried out predominantly from August to October, except for 1982 and 1985 when they began in July. From 1986 onwards they took place from June to October. Aerial surveys were flown mainly from July to November, with some flights taking place in January, April, May and June.

Equipment

The vessels used throughout the field work were 5–7m boats – predominantly inflatables. The aircraft used were *Cessna* 185s on floats. The most effective work was carried out from the inflatable boats, due to their manoeuvrability, stability, speed and safety.

We used 35mm SLR cameras mounted with 70–200mm zoom lenses enabling the photographer to adjust for variation in distance to the subject. In order to photograph the entire flank of the animal in one sequence, a winder or motor drive was used. A data back was used to record date, time, roll and frame numbers directly onto the film. This, combined with field notes for each roll, facilitated sorting and helped to avoid ambiguities during subsequent analysis of the photographs. In order to enhance contrast, yellow filters were used on overcast days and polarising filters on bright days.

Pictures were taken using black and white 400 ASA film and a short exposure time (1/1000s). *Kodak* T-Max 400 film with T-Max developer gave the best results, due to its versatility in varying light conditions and ease of manipulation in the darkroom. Pushing the film speed to 800 ASA achieved greater contrast while retaining a fine level of grain in the image. The T-Max developer also worked well with *Ilford* HP5 film.

We discourage the use of colour film in general, due to the higher cost and because of the overall loss of image quality when transferred to black and white film. If colour film is used, slides are preferred. Kodachrome yields better results than Ektachrome type films when transferred to black and white for later analysis. Slides and colour negatives are more difficult to use when matching and are more easily damaged than black and white prints.

Printing

To achieve the desired print contrast, a polycontrast resin coated paper was used in conjunction with contrast filters graded from 2.5 to 4.5. This method highlighted the mottling better. We found that the appropriate picture format for cataloguing our identification photographs was 2.5 x 8" (about 6.4 x 20.4cm); this can accommodate the whale's flanks and the fine detail of the pigmentation pattern.

Each photograph was labelled with date, position, roll and frame numbers, photographer's name, catalogue code and codes of associated animals for each particular sighting.

Grading of photographs

All photographs were graded for quality of image from A to C. When grading the quality of photographs we took into account the sharpness of image, the lighting and whether or not the image was large enough that the markings could be seen clearly. Pictures were rejected because of poor focus, lighting and too great a distance from subject, to avoid poor images and therefore ambiguity in matching. Pictures graded A and B were

considered good enough to be given a code number, catalogued and used for population estimates. Poor quality or grade C photographs were kept on file if identifying features could be adequately discerned for possible future matching. Suites of photographs were kept for each whale, which included the head and tail, in addition to the primary left and right flank pictures. The catalogue was reassessed and updated at least once a year in order to ensure inclusion of the best and most recent photographs.

Because photographs of injuries were very useful in matching, we closely monitored wounds and scars through photographs in order to determine any change in their shape or colouration.

Photographic technique

To avoid distorted images, we positioned ourselves between the sun and the whale, perpendicular to its flank, just ahead of the dorsal fin. The dorsal fin acts as a point of reference and not as an identification cue, unless it is scarred or deformed. To be certain that the sides photographed belonged to the same animal, we concentrated our efforts on one whale at a time and both sides of an individual, from head to tail, were taken during an encounter. To photograph as much of each side as possible, the identification pictures were taken when the whale rounded out to dive. Every attempt was made to avoid glare reflecting off the animal's body and backlighting, because both rendered photographs practically useless for identification. In addition, blank frames were taken to separate individuals on the film, in order to avoid possible ambiguities in identification during subsequent analysis.

Because 14% of the blue whales we observed raised their flukes when diving, we felt that it was important to photograph the flukes as part of the identification when possible. This was done once the sides had been photographed by falling behind the whale and keeping a steady pace.

Reliable photo-identification pictures were taken from the air at an altitude of about 180m, with telephoto lenses ranging from 180mm to 300mm at f2.8.

Identification

In order to identify individual blue whales from photographs, we classified the pigmentation patterns into the following categories:

Balanced (Fig. 1) an even distribution and density of mottling along the whale's body from the blowholes to the tail;



Fig. 1. Balanced.

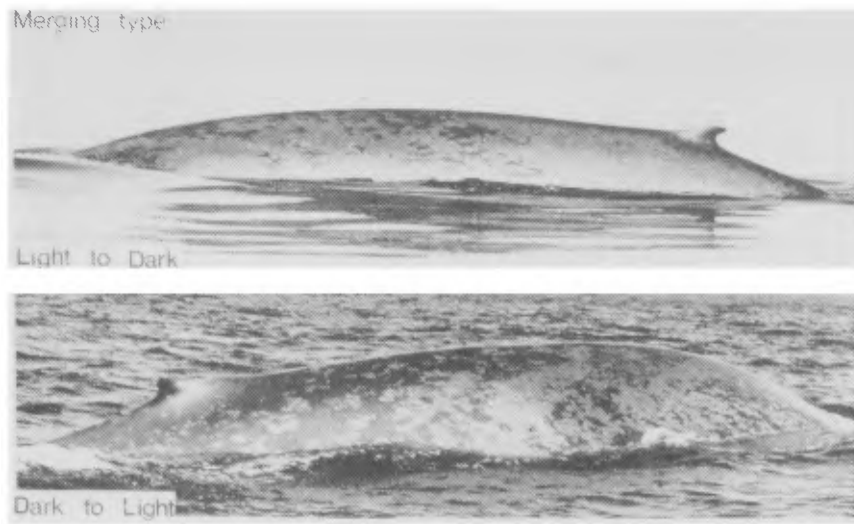

Fig. 2. Merging type.

Merging (Fig. 2) a posterior to anterior variation of the mottling density along the whale's body – this can be either (a) merging light to dark pigmentation background or (b) merging dark to light pigmentation background;

Tiered (Fig. 3) where the mottling densities vary in distinct dorso-ventral layers.

— Tiered and merging light to dark pigmentation background (Fig. 4).

These categories were further qualified by the following types:

Type 1 mottling density < 50%, dark patches standing out on a light background;

Type 2 mottling density $\geq 50\%$, dark patches standing out on a light background;

Type 3 mottling density < 50%, light patches standing out on a dark background;

Type 4 mottling density $\geq 50\%$, light patches standing out on a dark background.

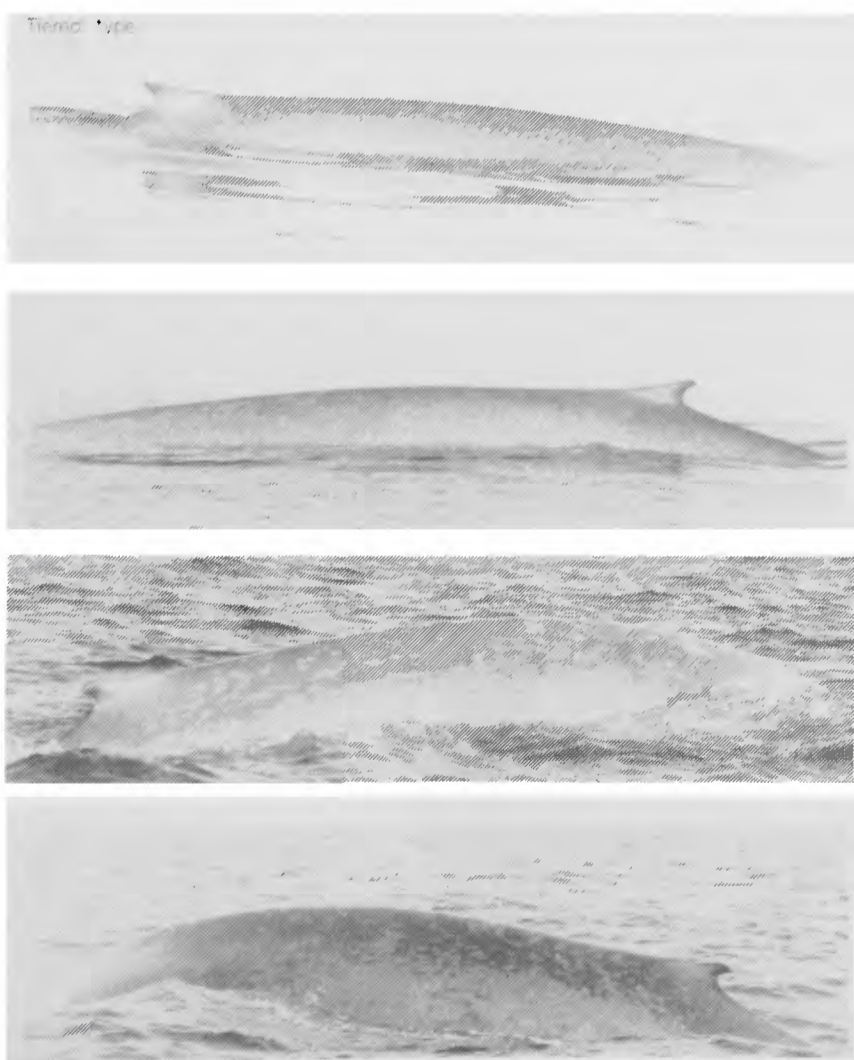

Fig. 3. Tiered type.

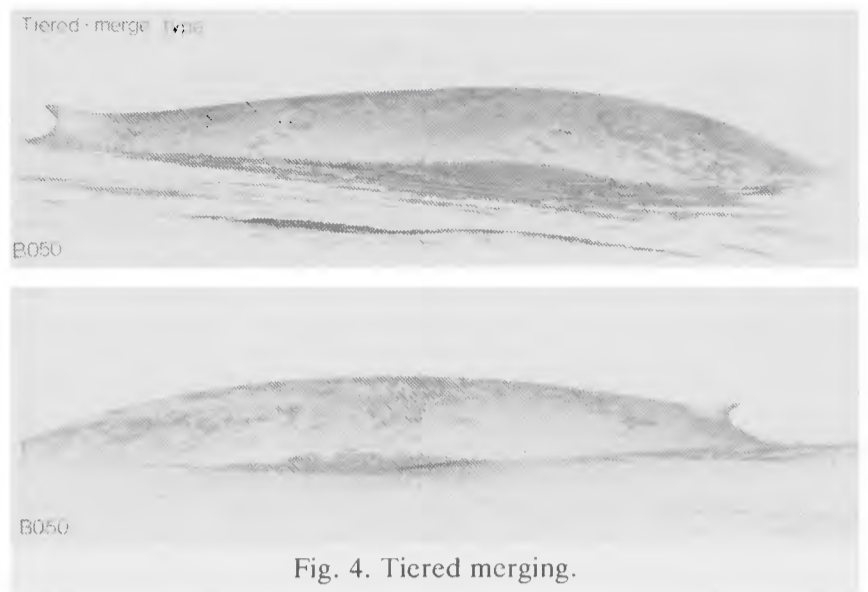

Fig. 4. Tiered merging.

Matching

When matching photographs, we concentrated on the distinctively highlighted patches of pigmentation and sought characteristics common with the above categories. This led us to similarly marked catalogued animals, increased accuracy and reduced the time spent in matching. The dorsal fin was included in all primary catalogue pictures and was used chiefly as a point of reference.

Photographs which did not clearly show the markings due to poor focus or extreme distortion and were deemed to be too ambiguous for accurate identification, were not used for matching. To limit errors, each new photograph was matched to the catalogue by a minimum of three people with matching experience. We found that mistakes could be avoided by matching the photographs when field observations were still fresh in the memory. In order to lessen the probability of error further, we found that it was best to limit matching to two hours periods; beyond that effectiveness was reduced by fatigue. The comparison of photographs was performed more efficiently when the photographs to be matched were placed on a well-lit wall at eye level.

Distinctive scars and deformities were used as secondary identification markings and, because there were useful markings along the full length of the whale's body, complete suites of photographs of each flank, head to tail, including the ventral surface of the flukes, were examined. This was necessary because pictures sent to us by other observers were not always in the preferred format.

RESULTS

Pigmentation

The characteristic mottling of blue whales was found predominantly on the sides and back from behind the blow holes to the end of the caudal peduncle. The head, flippers and flukes were generally devoid of mottling. The head was a solid bluish-grey; the ventral surface of the flukes could be striated, but was more commonly marked by solid tones of grey, while the dorsal surface was uniformly dark; the flippers were generally bluish-grey above and white, sometimes slightly pink, below. On many individuals a broad chevron-like pattern was evident, which swept down from the apex of the back, curved slightly forward as it extended down the sides. The dorsal fin was usually very small and varied greatly in shape.

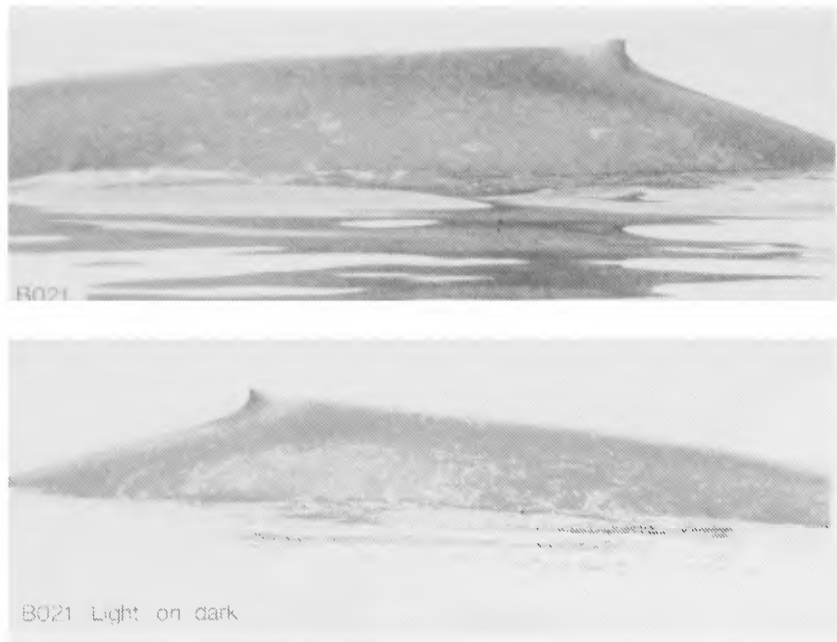

Fig. 5. Light on dark.

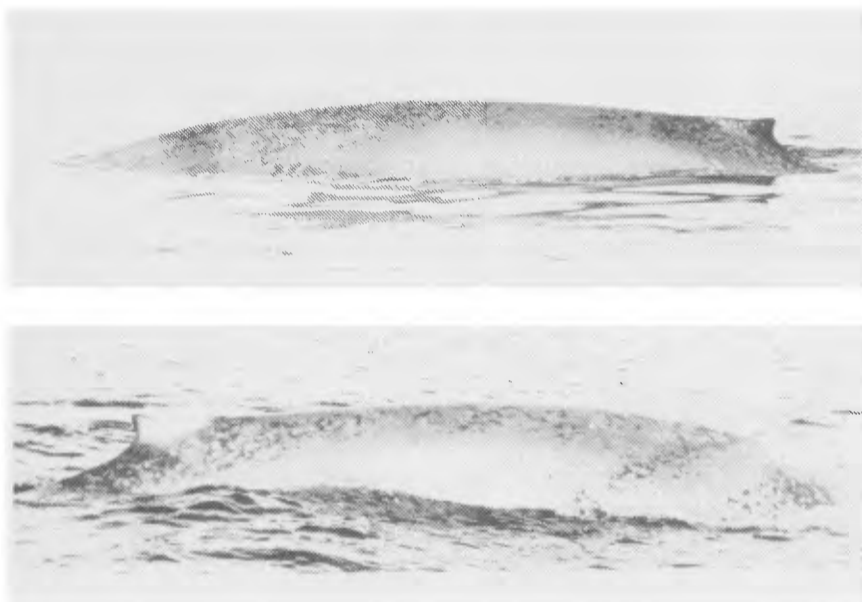

Fig. 6. Dark on light.

In general, two mottling configurations were prevalent: one where the body appeared to be mottled light on dark, due to fewer patches of pale (light) pigment on darker portions of the body (Fig. 5), while the other, found more commonly, flank, but with both sides carrying a similar overall configuration of pigmentation (Figs 1, 3–6). For example, an individual with light mottling on one flank at the level of the dorsal fin would not have dark heavy mottling at the same level on the other side.

A totally white dorsal fin was observed on 19(9%) of the individuals catalogued and at least 21%, had some white pigmentation on their dorsal fin. We did not detect changes in this naturally occurring white colouration over time and found it was useful as a secondary means of individual identification.

Injuries

Scarring was found on 14% of the blue whales observed in the Gulf of St. Lawrence. This could usually be attributed to contact with shipping and ice at least 9% of the individuals on file carried ship-induced scars. We observed whales with gashes several centimeters deep in the caudal peduncle (Fig. 7, B195) and one where the right fluke had been amputated. Such injuries were probably caused by the propellers of large vessels. The white scarring we assume is caused by contact with ice, is found typically on the tip of the rostrum, on the splash-guard in front of the blow holes and along the apex of the back – particularly in the area of the dorsal fin (Fig. 7, B001, B064).

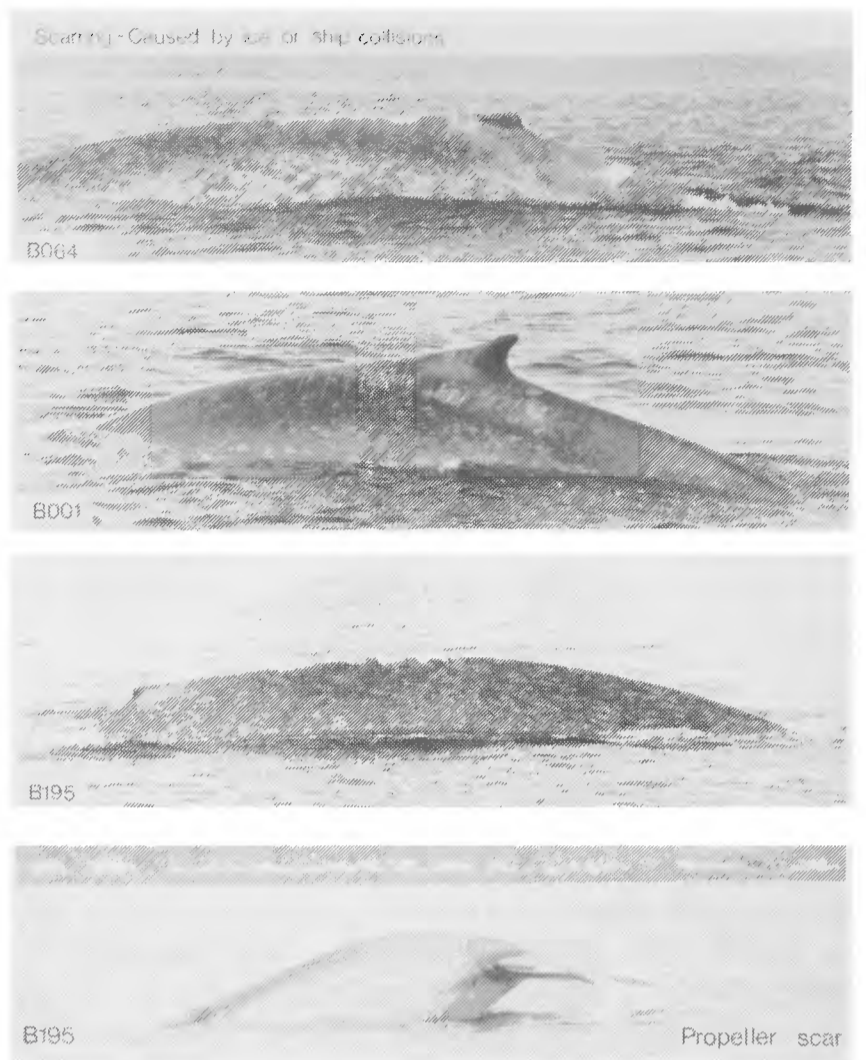

Fig. 7. B001, B064 – ice scarring. B195 – ship scarring.

In addition, there were two instances where individuals bore rake-like marks associated with killer whale attacks.

Desquamation and diatoms

We regularly observed blue whales with sheets of the epidermis peeling away from the body (desquamation). On five occasions, however, the desquamation severely affected the appearance of most of the whale's body (Fig. 8). Of the five instances of extensive desquamation observed, two caused mismatches by one of the three persons analysing the pictures.

In addition, blue whales were commonly observed covered in patches of yellow-green or brown films of diatoms (Fig. 9).

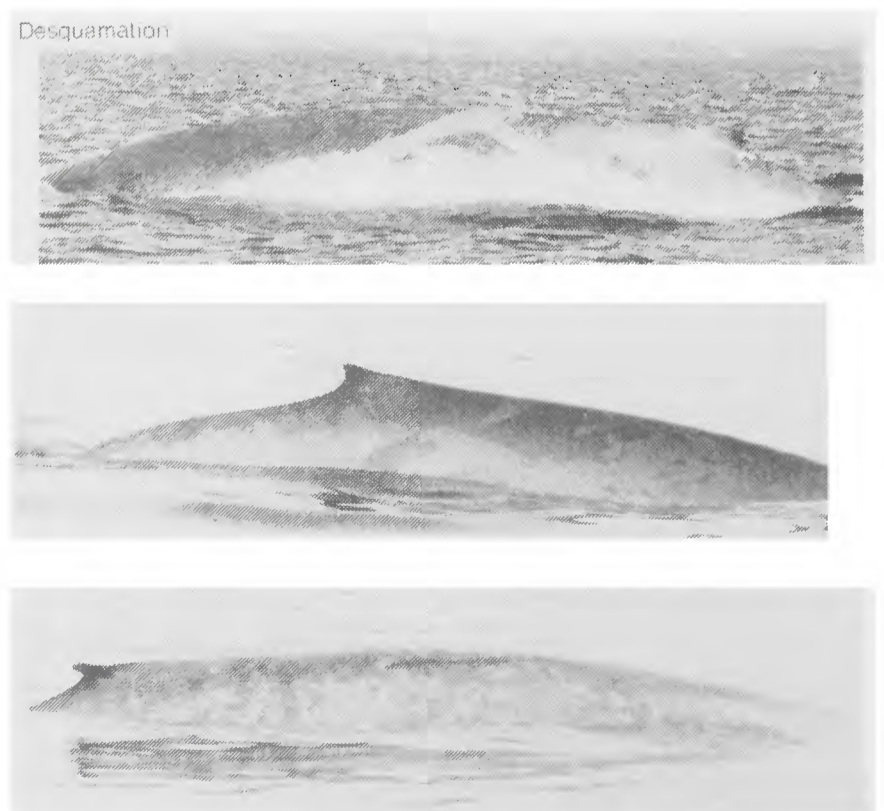

Fig. 8. Desquamation.

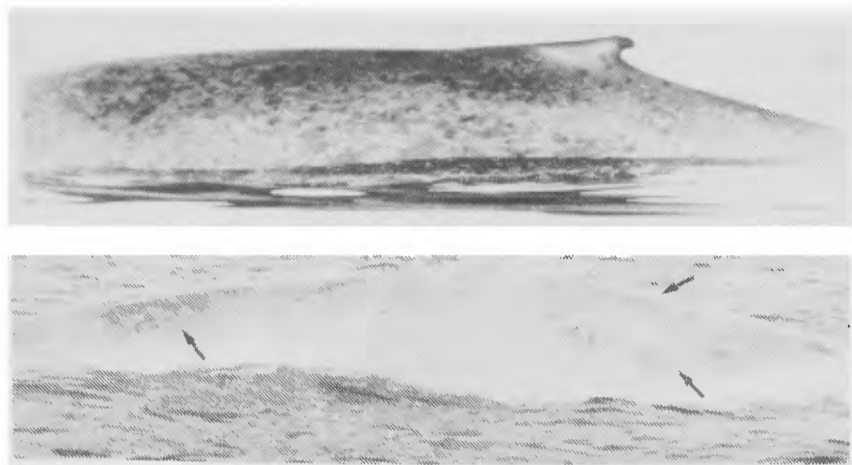

Fig. 9. Diatoms. Arrows indicate diatom patches.

Findings

Blue whales were seen as early as the first days of April and as late as November 30 along the North Shore of the Gulf from Sept-Iles to Pointe des Monts (Fig. 10). There was a peak in sightings from August through October for both vessel-based and aerial observations (Tables 1a and 2a), with the month of greatest sightings being September for the vessel-based observations and October for aerial observations. October was the month of the greatest number of sightings per hour for both vessel and aerial sightings (Tables 1b and 2b).

Blue whales were usually found singly or in pairs, with the mean pod size being 1.40 (SD 0.56). Concentrations of as many as 20 to 40 animals were found.

The longest residence time documented for blue whales in the Mingan Island study area was for two individuals (BO19 and BO52) swimming together as a pair – within a body length – during three weeks in September of 1982. Although no long term year to year pair bonds were observed, these same two whales were again found as a pair in the Mingan Island area for three weeks during

Table 1a

Gulf of St-Lawrence vessel surveys: blue whale sightings per month (1979 - 1988).

Year	June	July	August	Sept.	Oct.	Total
1979	-	-	9	-	-	9
1980	-	-	7	10	2	19
1981	-	-	10	13	4	27
1982	-	3	8	7	8	26
1983	-	0	15	22	2	39
1984	-	-	6	51	5	62
1985	-	1	41	75	21	138
1986	0	4	26	5	5	40
1987	3	3	17	9	15	47
1988	0	1	8	0	43	52
Mean	1.0	2.0	14.7	21.3	11.7	
Maximum	3	4	41	75	43	
Minimum	0	0	6	0	2	

September of 1984. However, these two whales have also been resighted in the same area at the same time, though not as a pair. Whale B052 was seen from 1982-7, while BO19 was observed from 1982-4 and 1987-8.

Of the 203 blue whales catalogued for the Gulf of St. Lawrence, 42% have been seen in more than one year (Table 3). We have detected no change in the mottled pigmentation of 46 individuals seen for at least four years, including an individual known for twelve years (see Table 4, Fig. 11).

We found that 52 (72%) of the whales that were regularly resighted over several seasons ranged widely along the north shore of the Gulf of St. Lawrence. In fact, four individuals travelled more than 400km in a two week period during the summer/fall months (Fig. 10).

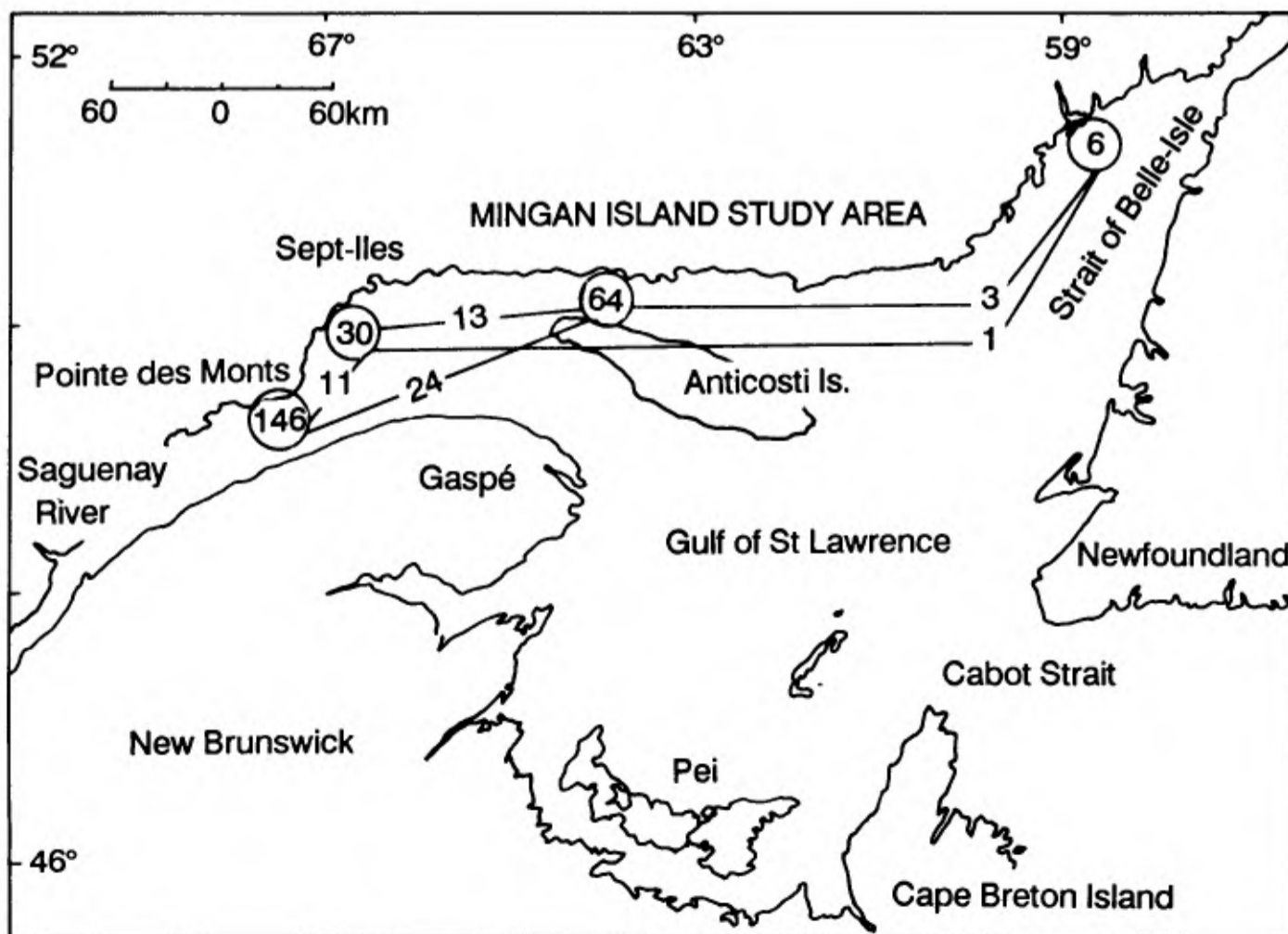

Fig. 10. Map of the Gulf of St. Lawrence indicating Mingan Island study area, Saguenay River and Strait of Belle-Isle. Identified individuals and numbers moving among areas are also shown.

Table 1b

Gulf of St-Lawrence vessel surveys: blue whale sightings/hr per month (1979-1988). No data indicates no effort for that period. Per hour sightings of blue whales peaked from August to October, with a slight increase into October.

Year	June	July	August	Sept.	Oct.	Mean
1979			0.16			0.16
1980			0.05	0.20	0.10	0.11
1981			0.06	0.11	0.07	0.08
1982		0.08	0.07	0.06	0.11	0.08
1983		0.00	0.30	0.17	0.03	0.12
1984			0.06	0.37	0.04	0.16
1985		0.02	0.40	0.54	0.38	0.33
1986	0.00	0.03	0.26	0.04	0.06	0.08
1987	0.04	0.02	0.12	0.13	0.57	0.17
1988	0.00	0.01	0.06	0.00	0.60	0.13
Mean	0.01	0.03	0.15	0.18	0.22	
Maximum	0.04	0.08	0.40	0.54	0.60	
Minimum	0.00	0.00	0.05	0.00	0.03	

Table 2a

Gulf of St-Lawrence aerial surveys: blue whale sightings per month (1979-1985). Surveys flown only during periods indicated by data.

Year	Jan.	May	July	Aug.	Sept.	Oct.	Nov.	Total
1979				11				11
1980					17			17
1981				9	16	32		57
1982	1	12	48	0	8	32	0	101
1983			0	1	2			3
1985						47		47
Mean	1	12	24	5.3	10.8	37	0	
Minimum	1	12	0	0	2	32	0	
Maximum	1	12	48	11	17	47	0	

Table 2b

Gulf of St-Lawrence Aerial Surveys: blue whale sightings/hr, per month (1979-1985). Surveys flown only during periods indicated by data.

Year	Jan.	May	July	Aug.	Sept.	Oct.	Nov.	Mean
1979				1.02				1.02
1980					0.41			0.41
1981				0.47	0.47	0.86		0.60
1982	0.10	0.57	1.15	0.00	0.13	0.47	0.00	0.35
1983				0.00	0.72	0.44		0.39
1985						1.96		1.96
Mean	0.10	0.57	0.58	0.55	0.36	1.10	0.00	
Maximum	0.10	0.57	1.15	1.02	0.47	1.96	0.00	
Minimum	0.10	0.57	0.00	0.47	0.44	0.47	0.00	

Although few blue whales have been sighted in the Gulf of Maine, one of the three photo-identified there (Wenzel *et al.*, 1988), has also been seen in the Gulf of St. Lawrence (Fig. 12). Another blue whale photographed from the air on the southern Scotian shelf in 1980 (CETAP, 1982) was seen in the Gulf of St. Lawrence in 1983 and 1985 (Fig. 12).

Five calves (2% of the whales catalogued) in the Gulf of St. Lawrence were seen during the ten years of the study.

Of the blue whales observed by us in the Gulf of St. Lawrence, 14% raised their flukes when diving.

Table 3

Number of newly identified and resighted blue whales per year. The whale resighted in 1979 was previously photographed in 1978 by other observers.

Year	Newly Identified	No. Resighted	Total Blue Whales	% Resighted
1979	8	1	9	11%
1980	15	3	18	17%
1981	18	6	23	26%
1982	15	6	22	27%
1983	17	20	37	53%
1984	35	17	52	33%
1985	59	31	91	34%
1986	3	16	20	80%
1987	12	21	33	64%
1988	21	30	51	59%
Totals	203	151		42%

Table 4

Range of years over which 203 individual blue whales were sighted in the Gulf of St-Lawrence (1979-1988). *One blue whale was photographed by other observers in 1973. R=range of years sighted; No.=number of animals; P=percentage of the population

R	N	P	R	N	P
*11	1	0.5%	5	11	5.4%
10	1	0.5%	4	12	6.0%
9	0	0.0%	3	10	4.9%
8	4	2.0%	2	10	4.9%
7	4	2.0%	1	16	7.8%
6	3	1.5%	0	131	64.5%

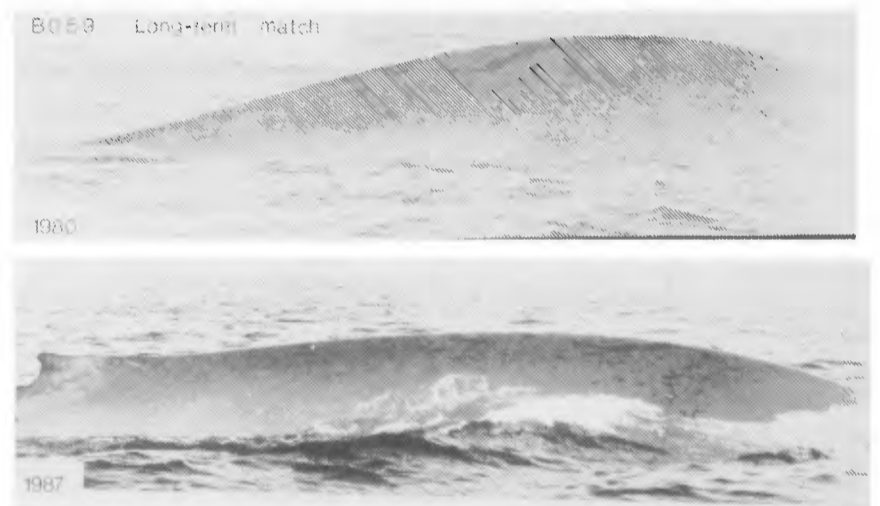

Fig. 11. Long-term match.

DISCUSSION

Pigmentation

The data presented here on the photo-identification of 203 blue whales indicate that the mottled pigmentation pattern characteristic of the species is unique to each individual. The mottling is distinct enough that individuals can easily be recognised through clear photographs of these natural markings. The amount of information available through photographs of a blue whale's flanks is sufficiently great that exact duplicates would be extremely unlikely.

Injuries

As described earlier, blue whales have become entrapped along the south coast of Newfoundland during the winter and spring with some regularity since at least 1958 (Mitchell, 1974, 1975, 1976, 1977, 1978, 1979, 1980, 1981

and 1982, and Lien *et al.*, 1987). Entrapments occur when whales are caught against the coast by sudden shifts in pack ice (Lien *et al.*, 1987). Whales that survive such imprisonments may be left with some scarring, the degree of which would vary depending on the amount of time they were caught. The injuries probably occur as the whale moves up and down to breathe and strikes the rough projections of ice beneath the surface. Other injuries occur due to collisions with shipping, which is heavy in the St. Lawrence Seaway, particularly during the months of peak whale activity. If the impact of a large vessel does not kill the whale, it can result in deep gashes several centimeters deep or even fluke amputations from contact with propellers (Fig. 7).

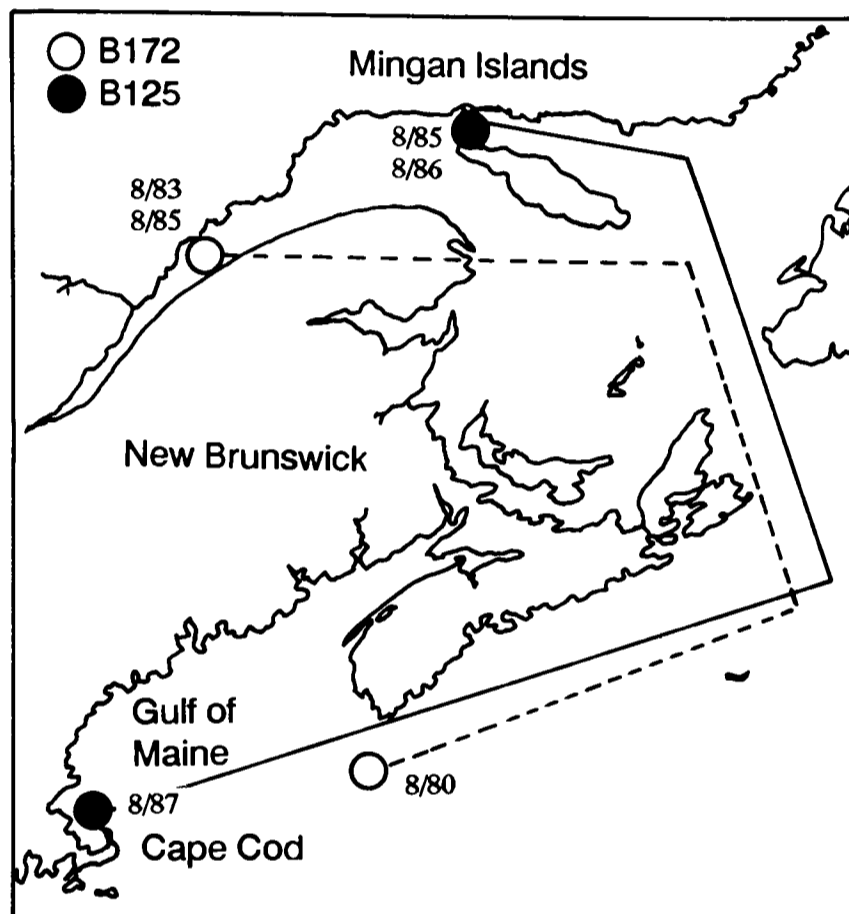

Fig. 12. Map GOM-GSL match.

Whatever the cause may be, the large white scars found on 14% of the blue whales observed in the Gulf of St. Lawrence appear to be stable over time and can, therefore, be relied upon for identification purposes. No change has been documented through photographs of the white scarring found on whale B064 (Fig. 7) over six seasons and on B022 for eight years. We found, however, that superficial scratches will fade and disappear within two years (Fig. 7, B001), as opposed to the large white scars and deep gashes described above.

Desquamation and diatoms

The occurrence of desquamation or skin-sloughing in blue whales caused problems in matching of photographs on two occasions. This peeling of the epidermis appears to occur regularly. When it is seen over a large part of the body, mistakes in matching can be made by inexperienced persons. Prior to the actual sloughing of the epidermis, the skin becomes heavily freckled with brown spots, which can mask the mottling. The skin begins to slough off the body at the point when the freckling becomes densest, giving the body a rust-coloured appearance. After the skin has peeled off, the mottling specific to that animal is again easily visible. The body surface appears very clean and bright at

that point. This sloughing of the epidermis is a normal, regular occurrence and can last from just a few hours to several days.

Blue whales found in cold waters are often covered with accumulations of diatoms, which can appear as rust-coloured blotches. The vast majority of diatoms found on whales belongs to one species: *Cocconeis ceticola* (Hart, 1935), (Fig. 9). Diatoms found on blue whales gave them either a yellow-green or rust which hindered recognition but in all instances the pigmentation could be seen adequately through the diatom coating.

Both the desquamation and diatoms slowed the matching process and caused temporary errors. However, careful analysis of the pictures by three different persons rectified any mismatches.

Findings

Blue whales were present in the Gulf of St. Lawrence from January to November and it can be assumed that they enter the Gulf through Cobot Strait during the break up of the ice in early spring (Lien *et al.*, 1987). The blue whale sighted in January of 1982 (Table 2a and 2b) was probably a straggler. We know that this whale survived the winter, because it was resighted the following year and recognised through photographs taken previously of scars along its back. Most blue whales, however, have probably left the Gulf by the end of December; beyond that their presence would be limited due to the formation of ice.

We found that blue whales dispersed widely along the north shore of the Gulf during the feeding season. Their apparent preference for the North Shore is probably due to the enhanced productivity created by strong tidal and current mixing, common to that coast (El-Sabh, 1979). During aerial surveys of the whole Gulf in 1982, blue whales were found to be most abundant along the North Shore (89%), from the Saguenay River to the Strait of Belle Isle (Sears and Williamson, 1982).

Of the blue whales catalogued, 42% have been resighted at least once, while 29% can be considered regular returnees, having been photographed in at least five different years. As we learn more about the blue whale and are able more consistently to photo-identify a larger proportion of those entering the Gulf of St. Lawrence each year, we may find that more of them are regular visitors to the Gulf. However, because blue whales seem to be very nomadic, with generally low local resident times, this will be difficult.

Collaboration in long term efforts between research groups is essential, because of the demanding nature of this work, requiring coverage of wide ranging animals over large areas. We believe that photo-identification is an essential tool for all field studies concerning the blue whale. Photographic catalogues of individually identified blue whales should be maintained, in order for such research to be effective. Collaborative research programmes can unite the efforts of different research groups and lead us to a better understanding of the distribution and migration of different blue whale populations. The use of photoidentification in conjunction with established capture-recapture statistical methods will hopefully give rise to more exact assessments of the blue whale in the Gulf of St. Lawrence and worldwide, but this will not be without problems (e.g. Hammond, Sears and Bérubé, 1990).

Every effort should be made to study the blue whale in other areas where they were once hunted. In the North Atlantic we suggest southern Greenland, Iceland, Norway, Spitsbergen and the Cape Verde Islands. In addition, because of blue whale stranding records in the Caribbean we feel that surveys in the offshore waters of the Gulf of Mexico and Central America could yield valuable results.

ACKNOWLEDGEMENTS

We wish to thank World Wildlife Fund, Canada and USA; Parks Canada; Hydro-Quebec; the US National Marine Fisheries Service (Woods Hole, Ma.) and the Cetacean Society International for their support of this work.

A great debt of gratitude is owed to those who have contributed to this research effort since 1979: Lisa Baraff, Marjolaine Bezeau, Christian Boutet, Simon Cadieux, Guy Coté, Eileen Fielding, Caroline Gibson, Benoit Hamel, Martha Lee, Marion Leger, Jean Lemire, Elizabeth Lowe, Mary Pratt, Martha Smythe, Dave Wiley and to those who have contributed photographs to the catalogue.

Special thanks go to Jean-Louis Belair, who tirelessly transferred hundreds of colour slides to black and white film on short notice, to Philip Hammond for his encouragement and instruction, and to the reviewers for their helpful comments.

REFERENCES

- CeTAP, 1982. A characterisation of marine mammals and turtles in the mid- and north-Atlantic areas of the US outer continental shelf. Cetacean and Turtle Assessment Program, University of Rhode Island, Bureau of Land Management contract No. AA551-CTB-48, US Dept of Interior, Washington, DC.
- El-Sabh, M., 1979. The lower St. Lawrence Estuary as a physical oceanographic system. *Le Naturaliste Canadien* 106:55-73.
- Hammond, P.S., Sears, R. and Bérubé, M. 1989. Estimating the number of blue whales in the Gulf of St. Lawrence and the Sea of Cortez. Paper SC/A88/ID44 (published in this volume).
- Hart, T.J., 1935. On the diatoms of the skin film of whales and their possible bearing on problems of whale movements. *Discovery Rep.*, 10:249-82, 1pl.
- Ingebrigtsen, Andr., 1929. Whales caught in the North Atlantic and other seas. *Rapp. Cons. Explor. Mer., Rapp. Proc.-verb. Reun.* 56:1-26.
- International Whaling Commission. 1990. Report of the Workshop on Individual Recognition and the Estimation of Cetacean Population Parameters (published in this volume).
- Jonsgård, A., 1955. The stocks of blue whales (*Balaenoptera musculus*) in the North Atlantic Ocean and adjacent Arctic waters. *Norsk. Hvalfangst.-Tid.*, 44:505-19.
- Jonsgård, A., 1966. The distribution of Balaenopteridae in the North Atlantic Ocean. pp.114-24. In: K.S. Norris (ed.) *Whales, Dolphins, and Porpoises*. Univ. of California Press, Berkeley and Los Angeles.
- Kalcher, F.H., 1940: Uber den Algenbewuchs auf sudlichen Walen. *Z. Fisch. Hilfswiss. Beihefte* 1:13-36.
- Katona, S.K., Harcourt, P.M., Perkins, J.S. and Kraus, S.D. 1980. Humpback Whales: A catalogue of individuals identified in the western North Atlantic by means of fluke photographs. Second edition, July 1980. College of the Atlantic, Bar Harbor, Maine. 169pp.
- Lien, J., Stenson, G.B., Booth, S. and Sears, R. 1987. Ice entrapments of blue whales (*Balaenoptera musculus*) in Newfoundland and Labrador (1978-1987). In: Abstracts from the North Atlantic Marine Mammal Association Conference. March 26-7, 1987, Boston, MA.
- Mitchell, E. 1974a. Present status of northwest Atlantic fin and other whale stocks. pp.108-69. In: W.E. Schevill (ed.) *The Whale Problem: a status report*. Harvard University Press, Cambridge, Massachusetts. i-viii + 419pp.
- Mitchell, E.D. 1974b. Progress report on whale research, May 1972-3. *Rep. int. Whal. Commn* 24:196-213.
- Mitchell, E.D. 1975. Progress report on whale research, May 1973-4. IWC Scientific Committee, 1974. *Rep. int. Whal. Commn* 25:270-82 (Appendix V, Annex Y).
- Mitchell, E.D. 1976. Progress report on whale research, June 1974-May 1975. *Rep. int. Whal. Commn* 26:444-7.
- Mitchell, E. 1977. Canadian progress report on whale research - June 1975-May 1976. *Rep. int. Whal. Commn* 27:73-85.
- Mitchell, E.D. 1978. Canadian Progress Report on Whale Research - June 1976-May 1977. *Rep. int. Whal. Commn* 28:95-9.
- Mitchell, E.D. 1979. Canada. Progress report on cetacean research June 1977-May 1978. *Rep. int. Whal. Commn* 29:111-4.
- Mitchell, E. 1980. Canada. Progress report on cetacean research June 1978 to May 1979. *Rep. int. Whal. Commn* 30:145-151.
- Mitchell, E. 1981. Canada. Progress report on cetacean research, June 1979-May 1980. *Rep. int. Whal. Commn* 31:171-9.
- Mitchell, E. 1982. Canada. Progress report on cetacean research, June 1980-May 1981. *Rep. int. Whal. Commn* 32:161-9.
- Payne, R., Brazier, O., Dorsey, E., Perkins, J.S., Rowntree, V. and Titus, A. 1981. External features in southern right whales (*Eubalaena glacialis*) and their use in identifying individuals. Springfield, VA: NTIS, PB81-161093, Report No. MMC-76/21. 77pp.
- Sears, R., Wenzel, F.W. and Williamson, J.M. 1987. The Blue Whale: A catalogue of individuals from the western North Atlantic (Gulf of St. Lawrence). Mingan Island Cetacean Study (MICS Inc.), St. Lambert, Qc. 27pp.
- Sears, R. and Williamson, J.M. 1982. A preliminary aerial survey of marine mammals for the Gulf of St. Lawrence to determine their distribution and relative abundance. Mingan Island Cetacean Study-Station de Recherche des Iles Mingan (MICS). Falmouth, Mass. and Sept-Iles, Quebec. MICS project MO6. Under Parks Canada contract No. 81-1272.
- Sergeant, D.E. 1982. Some biological correlates of environmental conditions around Newfoundland during 1970-79: harp seals, blue whales, and fulmar petrels. *NAFO Sci. Coun. Studies*, 5:107-10.
- Sergeant, D.E. 1966. Populations of large whale species in the western North Atlantic with special reference to the fin whale. Fish. Res. Bd Canada. Arctic Biol. Sta. Circular No. 9.
- Sutcliffe, W.H. and Brodie, P.F. 1977. Whale distribution in Nova Scotia waters. Fisheries and marine service (Canada). *Tech. Rep.* 722:1-83.
- Small, G.L. 1971. *The Blue Whale*. Columbia University Press, New York. 248pp.
- US Department of Commerce. 1981. Population estimates *Cetacea*. Marine Mammal Protection Act of 1972, Annual Report 1980/81, June 1981: 73.
- Wenzel, F.W., Mattila, D.K. and Clapham, P.J. 1988. *Balaenoptera musculus* in the Gulf of Maine. *Mar. Mamm. Sci.* 4(2): 172-5.

Sightings and Movements of Blue Whales off Central California 1986–88 from Photo-Identification of Individuals

J. Calambokidis¹, G.H. Steiger¹, J.C. Cabbage¹, K.C. Balcomb²,
C. Ewald³, S. Kruse⁴, R. Wells⁴ and R. Sears⁵

ABSTRACT

We summarize research into the relative abundance and movements of blue whales off central California using data from aerial surveys and photo-identification of individuals from vessels. The Gulf of the Farallones region (including north to Bodega Bay) was the primary study area; 1,457hrs of vessel surveys and 88hrs of aerial surveys were carried out from July to November 1986–88. Blue whales were seen on 776 occasions (1,315 animals, including duplicates). The relative abundance of blue whales in the Gulf of the Farallones increased over the three years. A total of 179 individual blue whales were photographically identified in the area from 1986 to 1988. Most individuals were identified in 1988 (101) and 1987 (75). Twenty-two (15%) of the identified whales were seen in more than one year and five (3%) were seen in all three years.

Blue whales were also individually identified in other regions of California (principally near Monterey Bay and Point Arena) using photographs taken on an opportunistic basis by the authors and collaborating researchers. In 1987 and 1988, five and three individuals, respectively were seen in both Monterey Bay and the Gulf of the Farallones; all but one travelled from Monterey Bay in August to the Gulf of the Farallones in late August and September. A large number of blue whales were seen north of the Gulf of the Farallones near Point Arena in middle to late October 1988 and 8 of the 17 animals identified were seen in the Gulf of the Farallones in September or October. Some of the blue whales identified in this study were also seen off Baja California, Mexico: nine animals seen in the Gulf of the Farallones were seen off the west coast of Baja or the Sea of Cortez, Mexico, including three identified in March and April of 1988 off Baja and seen in August or September 1988 in the Gulf of the Farallones or Monterey Bay.

INTRODUCTION

The blue whale (*Balaenoptera musculus*) is an endangered species as a result of depletion from commercial whaling. The North Pacific population is reported to be 1,600 (National Marine Fisheries Service, 1987; Gambell, 1976), however, this estimate is based on a small number of sightings during whale scouting trips in the early 1970s (Wada, 1973; Omura and Ohsumi, 1974). Commercial whaling for blue and other whales continued off California through the early 1960s from shore-based whaling stations including two in San Pablo Bay (Rice, 1963). Little research has been conducted on North Pacific blue whales since the end of commercial whaling. Blue whale occurrence in the 19th and early 20th centuries off central California was noted by Scammon (1874) and Starks (1922). Sightings of blue whales along the central California coast have been reported since the late 1970s (Huber, Boekelheide, McElroy, Henderson, Strong and Ainley, 1982; Dohl, Guess, Duman and Helm, 1983; Webber and Cooper, 1983; Dohl, 1984; Szczepaniak and Webber, 1985; Smith, Dustan, Au, Baker and Dunlap, 1986; Rondeau, 1987; and Schoenherr, 1988).

Photo-identification of individuals has been possible for a number of large cetacean species and has recently been reported for blue whales (Sears, 1987; Sears, Wenzel and Williamson, 1987; Calambokidis, Kruse, Cabbage, Wells, Balcomb; Steiger, 1987 and Sears, Williamson and Wenzel, 1990). In this paper we use photo-identification data to provide information on the movements and site

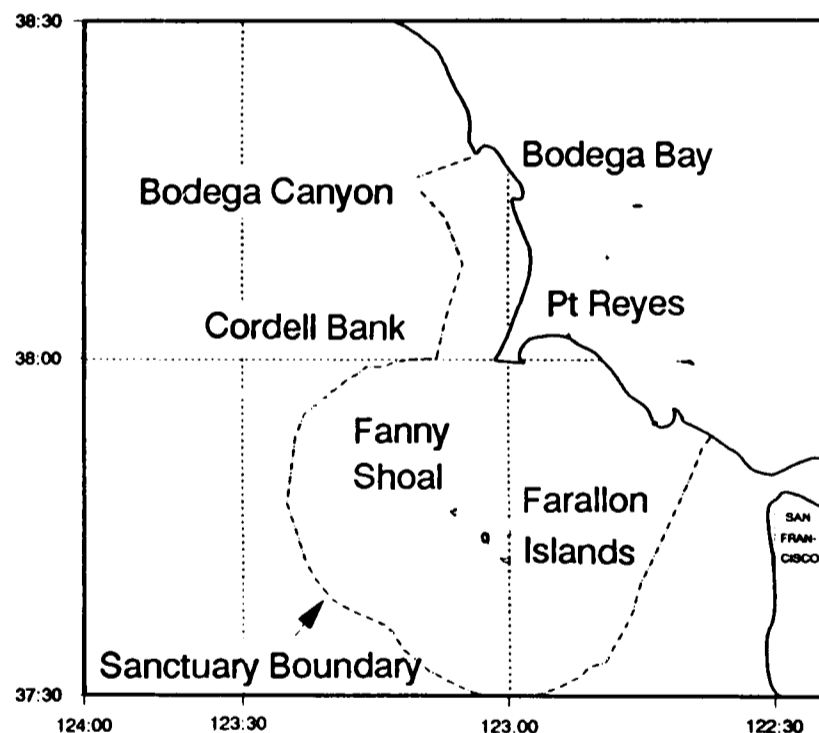

Fig. 1. Gulf of the Farallones region showing the boundary of the National Marine Sanctuary.

fidelity of whales in our study area (Fig. 1). Other findings from our blue whale research in the Gulf of the Farallones, including distribution, behavior, and length measurements, are reported elsewhere (Calambokidis, Steiger, Cabbage and Balcomb, 1989).

METHODS

The primary study region was the Gulf of the Farallones north to Bodega Bay (Fig. 1). Individual blue whales were photographed during vessel surveys conducted in 1986–88. Three vessel types were used: (1) *Noctilio*, a 44ft motor sailer; (2) *Shachi*, a 19ft Boston Whaler; and (3) 14 and 16ft *Achilles* inflatable boats. Vessel effort is summarized in Table 1. Blue whales were also photographed and recorded

¹ Cascadia Research, 218½ W. Fourth Ave., Olympia, WA 98501, USA.

² Center for Whale Research, 1359 Smugglers Cove Rd, Friday Harbour, WA, 98250, USA.

³ Farallon Research Associates, 76 Gates St., San Francisco, CA 94110, USA.

⁴ Long Marine Laboratory, University of California, Santa Cruz, CA 94064, USA.

⁵ Mingan Island Cetacean Study, 285 Green St., St Lambert, QC, J4P 1T3, CANADA.

Table 1

Summary of effort and blue whale sightings in 1986-88 in the Gulf of the Farallones. S=no. of sightings; W=no. of whales; Id=no. of identifications; D=no. of different individuals

Year	Effort		Blue whale sightings			Blue whales identified		
	Days	Hours	S	W	W.hr ⁻¹	Id	D	Id.D ⁻¹
<i>Vessels</i>								
1986	71	513	96	196	0.38	82	35	2.3
1987	58	460	209	338	0.73	136	75	1.8
1988	76	484	234	409	0.85	166	101	1.6
Total	205	1,457	539	943	0.65	384	179	2.1
<i>Aerial surveys</i>								
1986	9 ^a	33.5 ^a	27	51	1.5			
1987	7	25.4	75	105	4.1			
1988	6	22.8	135	216	9.5			
Total	22	81.7	237	372	4.6			

^aincludes flights of more than 1hr including transit time

during commercial nature trips to the Farallon Islands which were usually made from June through November. There was additional effort in Monterey Bay and other areas from a number of vessels on a more opportunistic basis. Aerial surveys were flown in 1986-88 in the Gulf of the Farallones in a *Cessna* 172 (Table 1). Aerial surveys were primarily used to locate animals for vessel-based photo-identification work.

Individuals were identified primarily by mottling and scarring patterns on the back (Sears *et al.*, 1987; Sears *et al.*, 1990); both the left and right sides of the body near the dorsal fin were photographed, as were the flukes if presented. We used motor-advance 35mm cameras with lenses from 180mm f2.8 to 300mm f4.5, and *Kodak* Tri-X or *Ilford* HP-5 black and white film. Shutter speeds were 1/1000 of a second or faster, when lighting conditions permitted. Film was exposed at an ISO rating of 1000, and development times were adjusted accordingly using *Edwal* FG7 1:1 with 9% sodium sulfite. Selected prints were enlarged on *Kodak* RC paper to facilitate comparison.

Photographs of blue whales taken off the coast of California and Mexico by other researchers (Table 2) were compared with those taken in this study. Most of these photographs were color transparencies. They were copied with a duplicator onto black and white negative film, and then printed as described above. Also included in this comparison were the photographs taken in the Sea of Cortez and other areas by members of the Mingan Island Cetacean Study. Results of these comparisons will be reported in more detail elsewhere but are summarized briefly here.

RESULTS

During vessel surveys in the Gulf of the Farallones in three study seasons (1986-88), over 500 sightings of 943 blue whales were recorded (Table 1). Concurrent aerial surveys recorded 237 sightings of 372 blue whales. A total of 179 different blue whales were photographically identified in the Gulf of the Farallones from 1986 to 1988 (Table 1).

Table 2

Names of researchers, naturalists and photographers, including those who worked on this study, who contributed photographs that have been incorporated into the blue whale catalog

Cascadia Research Collective and Center for Whale Research

K. Balcomb; L. Barry; S. Bartok; P. Bloedel; D. Bockus; J. Calambokidis; D. Claridge; J. Cabbage; G. Steiger; N. Wadsworth

Farallon Research Associates

C. Ewald; P. Jones; B. Keener; I. Szczepaniak; M. Webber

Long Marine Laboratory

D. Goley; S. Kruse; J. Östman; R. Wells

Moss Landing Marine Laboratory

N. Black; V. Dollarhide; T. Jefferson; T. Kieckhefer; C. Strong; C. Tanner; B. Tershy; B. Würsig

Other contributors

B. Agler; C. Alvarez; A. Brady; R. Branson; H. Clarke; B. Elliot; M. Ezikial; L. Findley; P. Folkens; G. Friedrichsen; R.D. Harris; Hopkins-Lions; T. Johnson; J. Law; S. Leatherwood; M. Lippsmeyer; F. Nicklin; D. Patten; R. Pittman; D. Robertson; H. Rondeau; D. Shearwater; R. Stallcup; J. Stern; R. Storro-Patterson; S. Swartz; M. Weinrich

Abundance

Blue whale numbers increased in the study area during the three years of research. The three possible measures of abundance available from our data all showed an increase: (1) number and rate of blue whale sightings from aircraft; (2) number and rate of blue whale sightings from vessels; and (3) number of animals identified in each of the three years. Despite a small decrease in aerial survey coverage each year, the number of blue whales seen increased from 51 animals in 1986 to 216 in 1988. The effort-corrected sighting rate showed a 600% increase over the three-year period. Sightings from vessel surveys also increased, but not by as much. Because of the more consistent and broader coverage, we believe the increase revealed in the aerial survey data to be more representative of the entire study area. The number of individuals identified increased each year, from 35 in 1986 to 101 in 1988.

Resightings

There were significant differences among years in the number of different days individual whales were seen within a year (Fig. 2, ANOVA, $p < 0.001$). Individuals were seen on an average of 2.1 days ($n=35$, $SD=1.2$) in 1986 compared with 1.6 days ($n=75$, $SD=1.1$) in 1987 and 1.4 days ($n=101$, $SD=0.9$) in 1988. The frequency of resightings of individual blue whales was similar in 1987 and 1988 when over 70% of the blue whales identified were seen on only one day and about 10% of the whales were identified on 3 or more days. Resighting rates were higher in 1986, when only 45% of individuals were seen on only one day and more than 30% were seen on 3 or more days.

The differences in resighting patterns among the three years can also be seen in the rate at which new whales were initially identified (discovered) in each season (Fig. 3). The shallow slope for 1986 indicates that an increasing proportion of the whales identified through the year had been seen earlier in the season. This is consistent with a small stable number of blue whales residing in the study area in 1986. The steep slope (approaching 45 degrees) for 1988 indicates that only a small proportion of whales were reidentified during the season. As the effort was similar in all three years, this is consistent with the larger number of blue whales seen in the study area in each year.

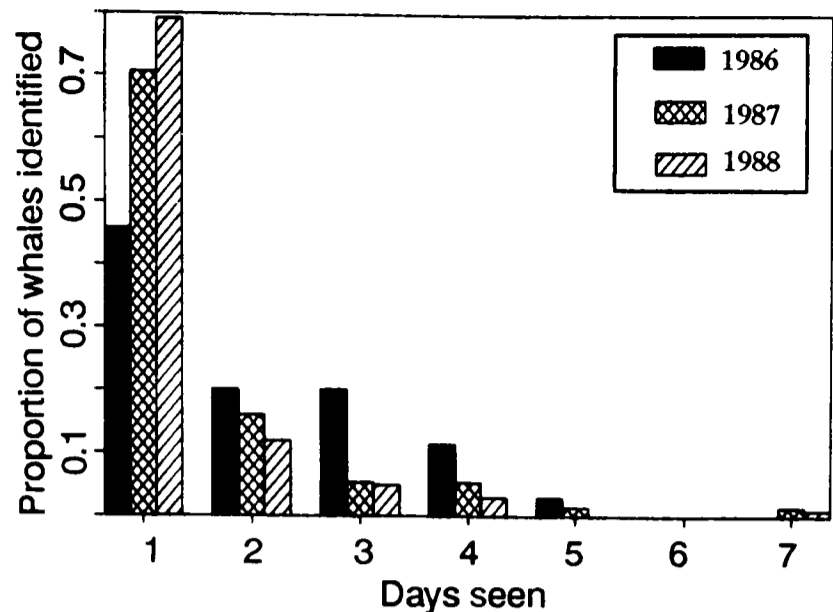

Fig. 2. Resighting frequencies of identified blue whales seen in the Gulf of the Farallones by year (1986-88).

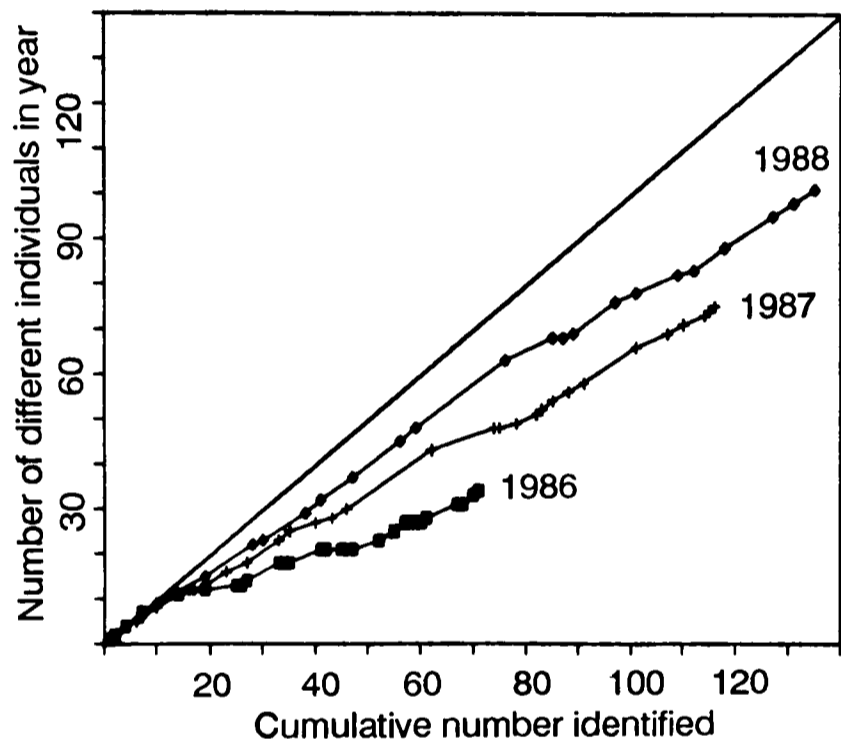

Fig. 3. Rate at which new whales were identified, or rate of discovery, in the Gulf of the Farallones region in 1986-88. The straight line shows the rate expected if all whales were seen on only one day (slope=1).

Some individual whales returned to the Gulf of the Farallones region in subsequent years. Twenty-two of 179 blue whales identified were seen in at least two of the three years (1986-88); five were identified across all three years. Resighting locations of two whales seen in all three years are shown in Fig. 4.

Residency and site fidelity

The sighting frequencies of individuals in 1987 and 1988 were higher for individuals that had been seen in a previous year. The average number of times an identified whale was seen in 1988 was significantly higher (t-test, $p < 0.001$) for those whales seen in 1986 ($n=11$, mean=3.0, SD=2.9) compared to those not seen in 1986 ($n=90$, mean=1.5, SD=0.88). A similar difference (t-test, $p < 0.001$) occurred for the 1988 sighting rates for whales that had been seen in 1987 ($n=15$, mean=2.7, SD=2.3) versus those not seen in 1987 ($n=86$, mean=1.5, SD=0.97). The sighting frequency of whales in 1987 followed a similar pattern (based on whether they had been seen in 1986) but the sightings rates were not significantly different (t-test,

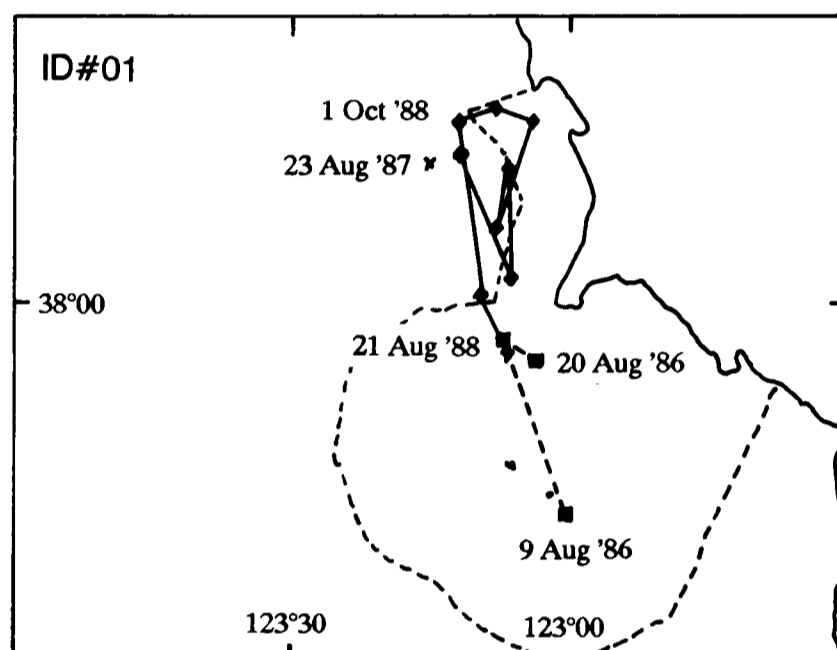
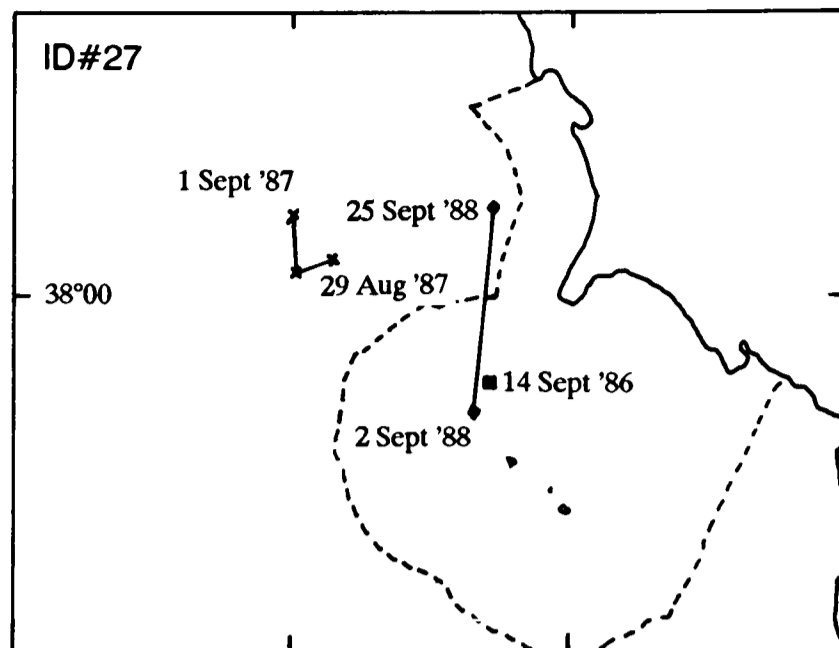

Fig. 4. Examples of seasonal and annual movements of individual blue whales in the Gulf of the Farallones region in 1986-88. Two individuals that were resighted in all three years (ID No.27 and No.01) are shown.

$p > 0.05$). In addition, of eight blue whales which had been individually identified in the Gulf of Farallones prior to our study, two (seen in 1984 and 1985) were identified there by us in both 1986 and 1987. These results suggest that a subgroup of blue whales regularly tends to return and stay longer in the Gulf of the Farallones. Consistent differences among individual whales in how easy they were to photograph, could also contribute to the observed patterns of resightings. This is unlikely, however, because we generally were able to photograph whales when we attempted to do so.

Movements between areas

Blue whales identified in the Gulf of the Farallones have also been seen off Monterey Bay (more than 60 n.miles to the south) and Point Arena (about 50 n.miles to the north) (Fig. 5). Eighteen identified whales were observed in both Monterey Bay and the Gulf of the Farallones and nine whales were sighted at both Point Arena and the Gulf of the Farallones. Many of the matches between Monterey Bay and the Gulf of the Farallones span a number of years; one animal identified in the Gulf in 1983 was seen in Monterey Bay in 1987 while an animal photographed by Gary Friedrichsen in Monterey Bay in 1975 was identified in the Gulf of the Farallones in 1986; an 11 year interval.

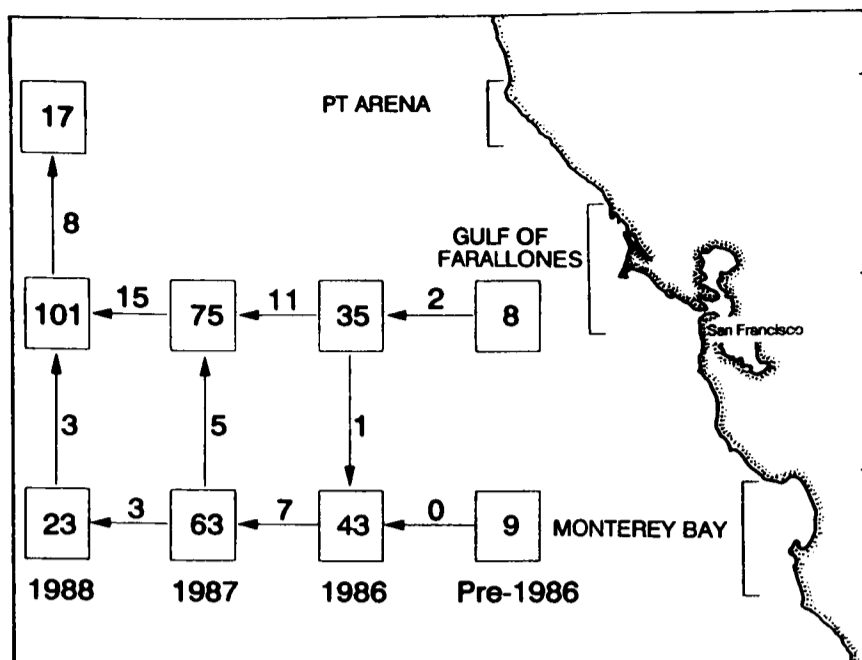

Fig. 5. Number of blue whales identified off central California by region and year (shown by the number in the boxes) and the number of matches among regions in the same year and between consecutive years for the same region are shown with arrows. The direction of the arrow indicates time (e.g. in 1988, blue whales were first identified in the Gulf of the Farallones and later off Point Arena). A second whale seen in 1986, first in the Gulf and then in Monterey Bay is not shown here but was part of the catalog of the Mingan Island Cetacean Study.

The movement of blue whales between the Gulf of the Farallones and Monterey Bay appeared to vary by year. However, little quantitative information on rates of interchange between these regions can be concluded from these results due to the sporadic effort in Monterey Bay.

In 1986, two blue whales were identified in August and September in the Gulf of the Farallones and then in mid-October in Monterey Bay. In 1987 and 1988, 5 and 2 blue whales, respectively, were identified in Monterey Bay in August and then seen in late August or early September in the Gulf of the Farallones. One individual in 1987 and one in 1988 followed a reverse course. Three animals moved between these regions in less than 15 days.

On 11 and 28 October 1988, 17 individuals were identified near Point Arena. Eight of these had been seen earlier in the year in the Gulf of the Farallones. The matching of almost half of the Point Arena whales with ones from the Gulf of the Farallones suggests a fairly cohesive movement of whales north from the study area. Two blue whales were identified in three regions (Gulf of the Farallones, Monterey Bay and Point Arena) in 1988.

Despite the movement of blue whales between Monterey Bay and Gulf of the Farallones there was a greater tendency for animals to return to the same area rather than go to other areas in consecutive years. Observed inter-year resightings for the same region (e.g. Gulf of Farallones whales identified in 1986 and returning in 1987 or 1988) were higher than expected and inter-year resightings between regions lower than expected if redistribution was random (chi-square, $p < 0.001$). Pooled values for each site and region were used because no significant heterogeneity was found in the values for each region and year (heterogeneity chi-square, $p > 0.05$; Zar, 1984).

Blue whales identified in the Gulf of the Farallones and Monterey Bay have been seen in the Sea of Cortez, Mexico and along the west coast of Baja California, Mexico in early spring. Nine of the whales identified in the Gulf of the Farallones matched whales photographed in Mexico by

people contributing photographs to the primary author or by members of the Mingan Island Cetacean Study. Five whales seen in Monterey Bay also matched whales photographed in Mexico.

Some of the resightings between Mexico and California are in the same year and demonstrate the migratory movement of at least a portion of the blue whale population. One whale seen on 17 March 1988 in the Sea of Cortez was identified in the Gulf of the Farallones on 2 September. A second whale seen in late March and early April outside Magdalena Bay along the west coast of Baja California was resighted in late September and October in the Gulf of the Farallones. A third whale seen in early April 1988 along the west coast of Baja California was identified in Monterey Bay on 12 August.

DISCUSSION

The increase in blue whale numbers seen in the Gulf of the Farallones from 1986 to 1988 reported here appears to be the continuation of an increase that began in the late 1970s or early 1980s. Sightings of blue whales in the vicinity of Southeast Farallon Island were uncommon in the 1970s. From 1970 to 1980 only one sighting of a blue whale was reported by biologists working on the Farallon Islands (Ainley, Huber, Henderson and Lewis, 1977; Ainley, Huber, Henderson, Lewis and Morrell, 1977; Ainley, Huber, Morrell and LeValley, 1978; Huber, Ainley, Morrell, LeValley and Strong, 1979; Huber, Ainley, Morrell, Boekelheide and Henderson, 1980; Huber, Ainley, Boekelheide, Henderson and Bainbridge, 1981). More frequent sightings of blue whales began in 1981 (Huber *et al.*, 1982; Huber, McElroy, Boekelheide and Henderson, 1983; Huber, Beckham, Nisbet, Rovetta and Nusbaum, 1985; Huber, Fry, Rovetta, Johnston and Nusbaum, 1986) and between 20 June and 30 October 1982, 10 sightings of 22 whales were made. Sightings of blue whales offshore from the Gulf of the Farallones in 1979 were reported by Smith *et al.* (1986). Monthly aerial surveys of the central and northern coast of California from 1980 to 1983 also suggested an increase in blue whale numbers in the Gulf of the Farallones region during this period (Dohl *et al.*, 1983; Dohl, 1984). No sightings were made in 1980, three were made in 1981 and eight in both 1982 and 1983 (Dohl, 1984, and estimated from figures in Dohl *et al.*, 1983).

The reason for the increase in blue whale occurrence in the Gulf of the Farallones is not clear but may reflect an increase in the total blue whale population and/or a shift in distribution to more coastal waters. Blue whale populations would be expected to increase because they have not been hunted in the North Pacific since 1966 but, other than the observations in central California, there have been no reports of increases in blue whale sightings in other areas of the North Pacific. Sightings of blue whales from Japanese whale scouting expeditions showed no increase from 1965 to 1978 (Wada, 1979; 1980). In the 1980s, no blue whales were seen in surveys of the Gulf of Alaska or Aleutian Islands (Rice and Wolman, 1982; Brueggeman, Green, Grotfendt and Chapman, 1987; Brueggeman, Green, Tressler and Chapman, 1988) where they were formerly hunted (Reeves, Leatherwood, Karl and Yohe, 1985; Brueggeman, Newby and Grotfendt, 1985).

Blue whales in the North Pacific often occur far offshore (Wade and Friedrichsen, 1979; Wada, 1980), but Dohl *et al.* (1983) reported a decrease in the depth of water in which blue whales were seen from 1980 to 1982. Smith *et al.* (1986) reported sightings of blue whales in 1979 offshore from the Farallon Islands at a time when blue whales were not being seen in the vicinity of the islands. These sightings (Dohl *et al.*, 1983; Smith *et al.*, 1986) were farther offshore than we have observed in recent years.

Blue whale sightings and the matches from photo-identification indicate that the blue whales seen in the Gulf of the Farallones and Monterey Bay share a common migratory route. The timing of the sightings allows some generalizations to be made about the movements of at least a subset of the population. Blue whales enter the Sea of Cortez from February to April and occur along the west coast of Baja California from March to at least June. They begin to appear in Monterey Bay and the Gulf of the Farallones area in June and July. The resighting data from Monterey Bay to Point Arena indicate that blue whales range widely from August to November, with yearly variation in the areas and times of occurrence of concentrations.

The stock identity of the California-Mexico blue whales in relation to areas to the north and south is not resolved. Previous information on the migrations and movements of blue whales along the coast of Mexico and California has been limited (Mizroch, Rice and Breiwick, 1984). Wade and Friedrichsen (1979) suggested that blue whales seen off Central America in December to February later migrated north to Mexico and California. Rice (1974) suspected that blue whales occurring along the Baja coast in early spring had migrated from California in the fall and were then proceeding north to British Columbia and the Gulf of Alaska. Obtaining identification photographs from these areas will be required to test these hypotheses.

ACKNOWLEDGEMENTS

This research was funded by the Gulf of the Farallones National Marine Sanctuary, National Oceanic and Atmospheric Administration. Nancy Stone and Miles Croom of the Sanctuary and Gary Fellers of the National Park Service provided advice and support for the study. Other researchers provided blue whale photographs for comparison with our catalogue (Table 2) and we greatly appreciate their help. Prentice Bloedel played an important role in the success of the study and provided the main research vessel (*Noctilio*). Dan Bockus, Diane Claridge, Stephanie Bartok, Prentice Bloedel, Heidi Rodingier, Nicola Wadsworth, Lisa Barry, Luke Bloedel, Jeanette Smith, Greg Falxa, Gary Falxa, Lea Mitchell, Stuart Goldman, Tom Ford, Gary Davis and J. Conover all assisted in data collection in the field. Tom Kieckhefer and Chris Tanner shared information from their work in the Gulf of the Farallones. Farallon Research Associates, under a subcontract, provided information on sightings and photographs taken from Oceanic Society nature trips. N. Haenel and Kelly Balcomb assisted with film developing; Joe Buchanan, Donald Smith, Suzanne Kort, Jennifer Horn, Elizabeth McManus, Jeff McGowan and Payton Carling helped in photographic printing and matching and data entry. Elizabeth McManus also assisted in literature search, data compilation and editing. The Bodega Marine Laboratory, including Paul Siri, Kitty Brown and Deke Nelson, provided housing and organized

and conducted a vessel survey using the *Avant Garde*; Ronn Storro-Patterson provided the *Delphinus. Achilles Inflatable Craft* provided the inflatable boats used in 1987 and 1988. Joseph Buchanan, John Francis, Jeff Laake, David Rugh and Dale Rice reviewed the manuscript. We thank these people and organizations.

REFERENCES

- Ainley, D.G., Huber, H.R., Henderson, R.P. and Lewis, T.J. 1977. Studies of marine mammals at the Farallon Islands, California, 1970-1975. Rep. to the US Mar. Mamm. Comm., Natl Tech. Info. Serv., PB-274 046, Springfield, Va. 42pp.
- Ainley, D.G., Huber, H.R., Henderson, R.P., Lewis, T.J. and Morrell, S.H. 1977. Studies of marine mammals at the Farallon Islands, California, 1975-1976. Rep. to the US Mar. Mamm. Comm., Natl Tech. Info. Serv., PB-266 249, Springfield, Va.
- Ainley, D.G., Huber, H.R., Morrell, S.H. and LeValley, R.R. 1978. Studies of marine mammals at the Farallon Islands, California, 1976-1977. Rep. to the US Mar. Mamm. Comm., Natl Tech. Info. Serv., PB-286 603, Springfield, Va.
- Brueggeman, J.J., Green, G.A., Grotefendt, R.A. and Chapman, D.G. 1987. Aerial surveys of endangered cetaceans and other marine mammals in the northwestern Gulf of Alaska and southeastern Bering Sea. Report to the Minerals Management Service, Alaska OCS Office, and NOAA Office of Oceanography and Marine Assessment, Alaska Office (unpublished).
- Brueggeman, J.J., Green, G.A., Tressler, R.W. and Chapman, D.G. 1988. Shipboard surveys of endangered cetaceans in the northwestern Gulf of Alaska. Report to the Minerals Management Service, Alaska OCS Office, and NOAA Office of Oceanography and Marine Assessment, Alaska Office (unpublished).
- Brueggeman, J.J., Newby, T.C. and Grotefendt, R.A. 1985. Seasonal abundance, distribution, and population characteristics of blue whales reported in the 1917 to 1939 catch records of two Alaska whaling stations. *Rep. int. Whal. Commn* 35:405-11.
- Calambokidis, J., Kruse, S., Cabbage, J.C., Wells, R., Balcomb, K.C. and Steiger, G.H. 1987. Blue whale occurrence and photo-identification along the central California coast. Presented to the Seventh Conference on the Biology of Marine Mammals, Miami, Florida, December 1987 (unpublished).
- Calambokidis, J., Steiger, G.H., Cabbage, J.C. and Balcomb, K.C. 1989. Biology of blue whales in the Gulf of the Farallones and adjacent areas of California. Final Report to the Gulf the the Farallones National Marine Sanctuary, NOAA, San Francisco, California (unpublished). 56pp.
- Dohl, T.P. 1984. Harbor porpoise and other cetaceans of the Farallon Basin. Southwest Fish. Cent. Adm. Rep. LJ-84-16C, Natl Mar. Fish. Serv., La Jolla, Calif.
- Dohl, T.P., Guess, R.C., Duman, M.L. and Helm, R.C. 1983. Cetaceans of central and northern California, 1980-1983: Status, abundance, and distribution. OCS Study MMS 84-0045, Minerals Management Service, US Dept. Int., Wash. DC (unpublished).
- Gambell, R. 1976. World whale stocks. *Mamm. Rev.* 6:41-53.
- Huber, H.R., Ainley, D.G., Boekelheide, R.J., Henderson, R.P. and Bainbridge, B. 1981. Studies of marine mammals at the Farallon Islands, California, 1979-1980. Natl Tech. Info. Serv., PB81-167082. Springfield, Va.
- Huber, H.R., Ainley, D.G., Morrell, S.H., Boekelheide, R.J. and Henderson, R.P. 1980. Studies of marine mammals at the Farallon Islands, California, 1978-1979. Rep. to the US Mar. Mamm. Comm., Natl Tech. Info. Serv., PB80-178197. Springfield, Va.
- Huber, H.R., Ainley, D.G., Morrell, S., LeValley, R.R. and Strong, C.S. 1979. Studies of marine mammals at the Farallon Islands, California, 1977-1978. Rep. to the US Mar. Mamm. Comm., Natl Tech. Info. Serv. PB80-111602. Springfield, Va.
- Huber, H.R., Beckham, C., Nisbet, J., Rovetta, A. and Nusbaum, J. 1985. Studies of marine mammals at the Farallon Islands, California, 1982-1983. Southwest Fish. Cent. Adm. Rep. LJ-85-01C, Natl Mar. Fish. Serv., La Jolla, Calif.
- Huber, H.R., Boekelheide, R.J., McElroy, T., Henderson, R.P., Strong, C. and Ainley, D.G. 1982. Studies of marine mammals at the Farallon Islands, California, 1980-1981. Rep. to the Natl Mar. Fish. Serv., Contract No.81-ABC-00129 (unpublished).
- Huber, H.R., Fry, L., Rovetta, A., Johnston, S. and Nusbaum, J. 1986. Studies of marine mammals at the Farallon Islands, California, 1983-1985. Southwest Fish. Cent. Adm. Rep. LJ-86-17C, Natl Mar. Fish. Serv., La Jolla, Calif.

- Huber, H.R., McElroy, T., Boekelheide, R.J. and Henderson, P. 1983. Studies of marine mammals at the Farallon Islands, California, 1981–1982. Southwest Fish. Cent. Adm. Rep. LJ-83-09C, Natl Mar. Fish. Serv., La Jolla, Calif.
- Mizroch, S.A., Rice, D.W. and Breiwick, J.M. 1984. The blue whale, *Balaenoptera musculus*. *Mar. Fish. Rev.* 46:15–19.
- National Marine Fisheries Service. 1987. Marine Mammal Protection Act of 1972. Annual Report 1986/87. Natl Oceanic and Atm. Adm., US Dept. Comm., Wash., DC.
- Omura, H. and Ohsumi, S. 1974. Research on whale biology of Japan with special reference to the North Pacific stocks. pp.196–208. In: W.E. Schevill (ed.) *The Whale Problem. A Status Report*. Harvard University Press, Cambridge, Mass. 419pp.
- Reeves, R.R., Leatherwood, S., Karl, S.A. and Yohe, E.R. 1985. Whaling results at Akutan (1912–39) and Port Hobron (1926–1937), Alaska. *Rep. int. Whal. Commn* 35:441–57.
- Rice, D.W. 1963. Progress report on biological studies of the larger Cetacea in the waters off California. *Norsk Hvalfangstid.* 7:181–7.
- Rice, D.W. 1974. Whales and whale research in the eastern North Pacific. pp. 170–95. In: W.E. Schevill, (ed.) *The Whale Problem, A Status Report*. Harvard University Press, Cambridge, Mass. 419pp.
- Rice, D.W. and Wolman, A.A. 1982. Whale census in the Gulf of Alaska, June to August 1980. *Rep. int. Whal. Commn* 32:491–7.
- Rondeau, J.H. 1987. The Farallon Islands 1542–1986, an ecosystem review. Unpublished report, P.O. Box 620458, Woodside, California. 239pp.
- Scammon, C.M. 1874. *The Marine Mammals of the Northwestern Coast of North America*. G.P. Putnam's Sons, New York.
- Schoenherr, J.R. 1988. Blue whales feeding on high concentrations of euphausiids around Monterey Submarine Canyon. Unpublished masters thesis presented to Moss Landing Marine Laboratories, San Jose State Univ., San Jose, Calif. 43pp.
- Sears, R. 1987. The photographic identification of individual blue whales (*Balaenoptera musculus*) in the Sea of Cortez. *Cetus* 7:14–7.
- Sears, R., Wenzel, F.W. and Williamson, J.M. 1987. The blue whale: A catalogue of individuals from the western North Atlantic (Gulf of St. Lawrence). Mingan Island Cetacean Study, St. Lambert, Quebec (unpublished). 27pp.
- Sears, R., Williamson, J.M. and Wenzel, F.W. 1990. Photographic identification of the blue whale (*Balaenoptera musculus*) in the Gulf of St. Lawrence, Canada. Paper SC/A88/ID23 (published in this volume).
- Smith, R.C., Dustan, P., Au, D., Baker, K.S. and Dunlap, E.A. 1986. Distribution of cetaceans and sea-surface chlorophyll concentrations in the California Current. *Mar. Biol.* 91:385–402.
- Starks, E.C. 1922. A history of California shore whaling. *Fish. Bull.* 6:1–38.
- Szczepaniak, I.D. and Webber, M.A. 1985. Summer and autumn sightings of marine mammals in the Gulf of the Farallones, California 1983–1984. Rep. to Oceanic Society Expeditions, San Francisco, Calif, (unpublished).
- Wada, S. 1973. The ninth memorandum on the stock assessment of whales in the North Pacific. *Rep. int. Whal. Commn* 23:164–9.
- Wada, S. 1979. Indices of abundance of large sized whales in the North Pacific in the 1977 whaling season. *Rep. int. Whal. Commn* 29:253–63.
- Wada, S. 1980. Japanese whaling and whale sighting in the North Pacific 1978 whaling season. *Rep. int. Whal. Commn* 30:415–24.
- Wade, L.S. and Friedrichsen, G.L. 1979. Recent sightings of the blue whale, *Balaenoptera musculus*, in the northeastern tropical Pacific. *Fish. Bull., US* 76:915–9.
- Webber, M.A. and Cooper, S.M. 1983. Autumn sightings of marine mammals and birds near Cordell Bank, California 1981–82. Cordell Bank Expeditions, Walnut Creek, Calif. (unpublished). 44pp.
- Zar, J.H. 1984. *Biostatistical Analysis*. Prentice-Hall, Inc., Englewood Cliffs, N.J. 718pp.

Fin Whale (*Balaenoptera physalus*) Photographic Identification: Methodology and Preliminary Results from the Western North Atlantic

Beverly A. Agler¹, Judith A. Beard¹, Robert S. Bowman¹, Harriet D. Corbett¹, Steven E. Frohock², Mary P. Hawvermale³, Steven K. Katona¹, Samuel S. Sadove⁴ and Irene E. Seipt⁵

ABSTRACT

This paper describes the methods and terminology used to identify individual fin whales, *Balaenoptera physalus*, by photographs of their dorsal fins, pigmentation patterns and acquired scars. Approximately 746 fin whales have been contributed by research groups from the east coast of the USA and Canada to form the North Atlantic Finback Whale Catalogue. Analysis of 151 individuals photographed from 1974–87 in the Mt Desert Rock, Maine (43°58'N, 68°06'W) area has been completed. Features used to identify individuals remained stable for up to 14 years, although some scars were transitory. We observed seasonal residency periods of 4–8 weeks and 34% of the individuals analysed were photographed during more than one field season. Eighteen whales (12%) were resighted at other locations in the Gulf of Maine, including the Bay of Fundy, Jeffreys Ledge and Stellwagen Bank. Seventeen females with calves were identified during the study period. Eight of these females were observed with calves in more than one year and these calving intervals ranged from 2 to 6 years.

INTRODUCTION

Fin whales, *Balaenoptera physalus*, are distributed throughout the world (Leatherwood, Caldwell and Winn, 1976; Gambell, 1985) and although once considered abundant, their populations were greatly reduced by harvesting (Braham, 1984).

Effective management requires, amongst other things, knowledge of a species' life history and demographic information, but this is only partially available for North Atlantic fin whales. Migration patterns, geographical and temporal locations of wintering, mating and calving grounds, stock structure and size, seasonal range of individuals, habitat use and partitioning, and individual reproductive histories are poorly known. For many years scientists have recognised the need to mark whales in order to acquire such basic biological information. Long-term studies using photo-identification techniques have provided such data for other mysticetes (see review in IWC, 1990).

Fin whales have been the target of directed photo-identification studies in New England waters since the early 1980s (Mattila, Carlson, Clapham and Mayo, 1983; Agler and Katona, 1987). In this paper we discuss the methodology used to identify individuals and the problems encountered with these techniques. As an example, we present information on the residency patterns and movements suggested by data from the Mt Desert Rock, Maine, region.

METHODS

Features used for photo-identification

The asymmetrical body pigmentation of fin whales is unique to this species (True, 1904; Allen, 1916). On the right side of the head, the lower lip, upper lip (usually) and the first third of the baleen are white or pale gray. The lips and baleen on the left side are dark (Fig. 1). On the right side, the light coloration sweeps back to form a bold pattern, known as the blaze. The chevron, light coloration in the form of a 'V' (Mitchell, 1972; Leatherwood, Caldwell and Winn, 1976), originates behind the blowholes and curves back down both sides.

The shape of these pigment patterns varies among individual whales (Fig. 2). Other characteristics used to differentiate individuals include the profile of the dorsal fin (Fig. 3) and the shape and location of scars (Fig. 4).

Photograph collection techniques

We photographed fin whales from inflatable boats (equipped with outboard engines) and diesel-powered commercial whale watch boats, 15–50m long. 35mm SLR cameras with telephoto lenses (80–300mm) and motor drives were used. Some photographers used color slide film (Kodak Ektachrome ASA 200 and 400, and Kodachrome ASA 64 and 200) to obtain the broadest spectrum of color variations in the pigment pattern, while others (Clapham, 1987) preferred black and white prints (Kodak Tri-X ASA 400) for ease of handling.

We obtained a series of photographs of both sides of a whale whenever possible. We photographed the right side first, since the blaze was only visible on that side and the right chevron marking was usually broader and bolder. However we attempted to photograph the left side to document scars and the left chevron pattern. Because there is a striking difference in dorsal fin shape depending on camera angle, we photographed dorsal fins from the side, keeping the camera perpendicular to the plane of the fin.

¹ College of the Atlantic, Bar Harbor, Maine 04609

² Atlantic Cetacean Research Center, PO Box 1413, Gloucester, Massachusetts 01930

³ Mystic Marinelife Aquarium, 55 Coogan Blvd., Mystic, Connecticut 06355

⁴ Okeanos Ocean Research Foundation, PO Box 776, Hampton Bays, New York 11946

⁵ Center for Coastal Studies, PO Box 826, Provincetown, Massachusetts 02657

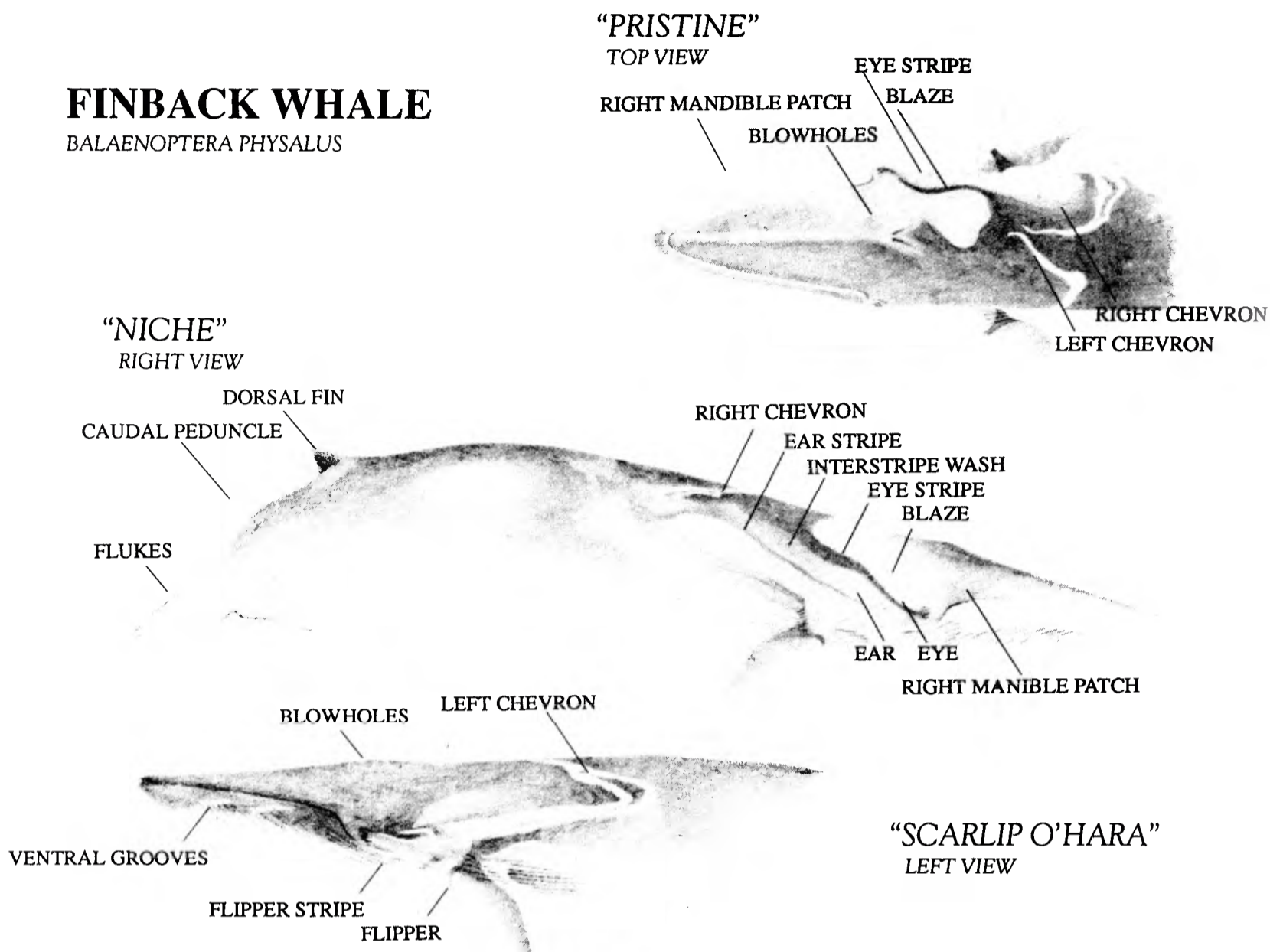

Fig. 1. This drawing illustrates the terminology recommended for use when describing the asymmetrical pigmentation patterns (Illustration by Harriet D. Corbett).

Locations for collection of photographs

Research on the recognition of individual fin whales has been conducted in the western North Atlantic in the areas listed below (Fig. 5). The number of whales and the years photographed are in parentheses. An asterisk signifies an estimate of the number of animals in a collection.

1. Northern Gulf of Maine, includes Mt Desert Rock, Maine and lower Bay of Fundy

(a) College of the Atlantic, Bar Harbor, Maine (151; 1974–1987).

(b) New England Aquarium, Boston, Massachusetts (20*; 1984–1987).

(c) Brier Island Ocean Study, Nova Scotia (30*; 1984–1988).

2. Southern Gulf of Maine, includes Stellwagen Bank and Jeffreys Ledge

(a) Atlantic Cetacean Research Center, Gloucester, Massachusetts (109; 1982–1986).

(b) Center for Coastal Studies, Provincetown, Massachusetts (156; 1979–1986).

(c) Web of Life Outdoor Education Center, Plymouth, Massachusetts (50*; 1984–1987).

(d) William Rossiter, Ridgefield, Connecticut (50*; 1979–1987).

3. New York Bight

(a) Okeanos Ocean Research Foundation, Hampton Bays, New York (200*; 1979–1988).

(b) Mystic Marinelife Aquarium, Mystic, Connecticut (48*; 1986–1988).

4. Gulf of St. Lawrence

(a) Mingan Island Cetacean Study, Sept-Iles, Quebec (200*; 1985–1988).

5. Canadian Maritimes

(a) Memorial University, St. John's, Newfoundland (50*; ?-1988).

(b) Dalhousie University, Halifax, Nova Scotia (50*; 1978–1988).

We estimate that there are 1,096 whales potentially available for inclusion in the North Atlantic Finback Whale Catalogue. To date, photographs of approximately 746 whales have been submitted. We have analysed the data for 151 individual animals from Mt Desert Rock, Maine and catalogued 333 unique individuals from the northern and southern Gulf of Maine.



Fig. 2. Examples of unique chevron/blaze patterns.

Organisation of the photographic catalogue

At a meeting in October 1986, the North Atlantic Marine Mammal Association (NAMMA) agreed to standardise photo-identification techniques for fin whales (Clapham, 1987). NAMMA selected College of the Atlantic (COA) to curate the North Atlantic Finback Whale Catalogue and merge several independent collections.

Each individually identified fin whale was represented in the catalogue by photographs of its distinctive features. When available we included a complete set of photographs of both sides of a whale, including blaze, chevron, dorsal fin and significant scars. Although scars alone were not a reliable feature, because they healed at varying rates, dorsal fins and scars used in combination were enough to identify some individuals. In cases when photographs were obtained of only the left side or when the dorsal fin was not photographed, the whale was included in the catalogue but was eliminated from statistical analyses.

To identify a new whale, we first used a computer database of dorsal fin shape (Fig. 6) and scars of all catalogued whales to produce a list of possible matches. We visually compared the new whale to this list; if there was no match, we then compared it to other whales with the same dorsal fin type, then to the rest of the catalogue.

If an animal did not match a previously catalogued individual, it was assigned a catalogue number, given a letter code to signify its dorsal fin type and included in comparisons with new photographs. Photographic matches were confirmed using the following criteria: (1) two project personnel, including the project director, must agree on the match; (2) at least three characteristics must be common to both sets of photographs; (3) one characteristic must be a major feature such as dorsal fin shape, chevron pattern or a substantial scar; (4) criterion 3 cannot be fulfilled by a non-distinctive dorsal fin (e.g. Type A in Fig. 6) without scars or nicks.

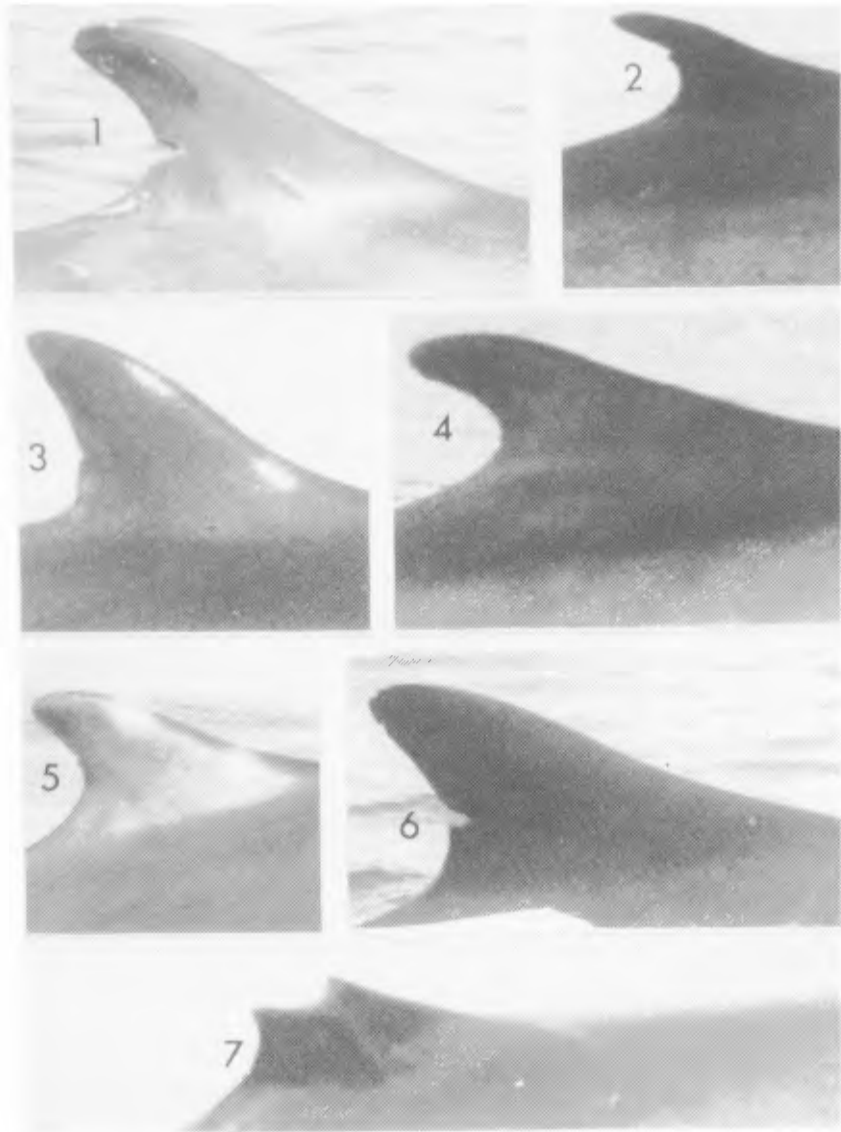

Fig. 3. Examples of each of the seven dorsal fin shapes: (1) Type A; (2) Type B; (3) Type C; (4) Type D; (5) Type E; (6) Type F and (7) Type O.

RESULTS

Photo-identification terminology

The following descriptions, developed by catalogue contributors, provide a common terminology to describe the features (pigmentation patterns, scar shape and location, and dorsal fin shape) used to identify individual fin whales.

Pigmentation patterns

The asymmetrical pigmentation of fin whales has been discussed by True (1904), Allen (1916), Mitchell (1972) and Leatherwood *et al.* (1976). Our terminology, listed below and illustrated in Fig. 1, follows those authors when possible.

Right mandible patch: White area on the lower right jaw.

Blaze: Light area found only on the right side. The blaze is located above the jawline, anterior to the eye stripe, and runs dorsally and laterally up to the midline near the blowholes. The blowholes themselves are usually dark.

Eye stripe: Dark line originating from the eye, running obliquely up and back, and widening into a large dark area on the shoulder.

Ear stripe: Dark line originating from the auditory meatus and running obliquely up and back. The ear stripe is approximately parallel to the eye stripe.

Interstripe wash: Light area between the eye stripe and the ear stripe.

Chevron: V-shaped pattern of light pigmentation originating behind the blowholes, and curving down both sides of the whale in a posterior, then anterior direction.

This pigmentation ends posterior to the ear stripe. Additional light coloration posterior to the chevron has not been named.



Fig. 4. Examples of body scars used in photo-identification of fin whales: (1) white patch on caudal peduncle; (2) propeller scars on back; (3) line scars in chevron; and (4) small circular depressions on sides.

Scar shape

Individual scars were categorised by shape and probable cause. These codes were stored in a computer database by body location.

Linear (L): lines less than 2 inches wide.

Scrape (S): linear markings greater than 2 inches wide.

Circular (C): round or circular shapes of any size.

Dent (D): any depression.

Tracks (T): linear scar intersected by perpendicular lines – probably caused by a small boat propeller.

Braid (B): large propeller scars that appear raised and often braided.

Piece missing (P): piece or chunk missing from the body, usually from the caudal peduncle.

Attachment (A): usually a parasitic copepod, lamprey, etc.

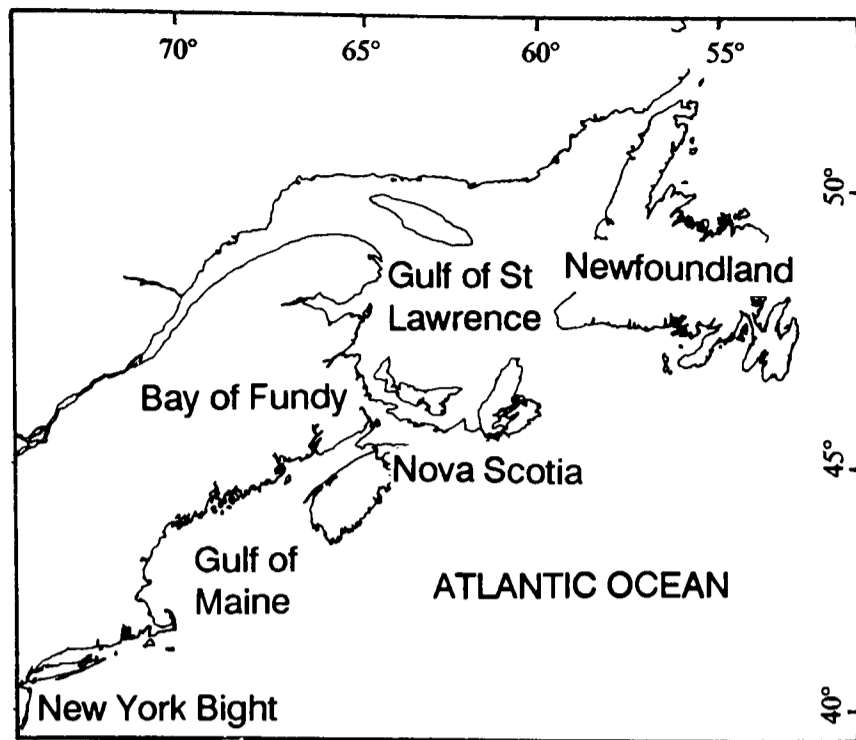

Fig. 5. Map of the study area.

Dorsal fin shape

Individuals were separated into seven categories based on the profile of the dorsal fin. Dorsal fin shapes were classified according to three features: the leading edge, the trailing edge, and the hump or bulge anterior to the fin. The categories are defined below (Fig. 6); the frequency of each type is listed in Table 1.

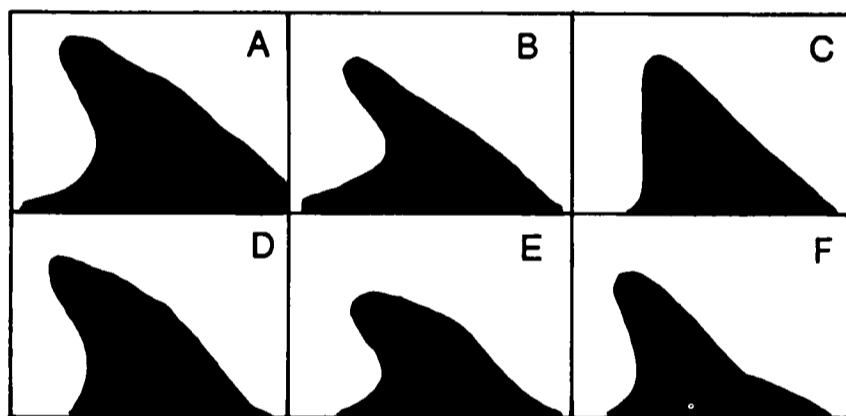

Fig. 6. Illustration of six of the seven dorsal fin types. Type O (7) is for any not fitting Types A-F.

Table 1

Fin type distribution.

	Total in catalogue	No. with nicks	No. with scars	No. without nicks or scars
Type A	61 (40%)	40 (26%)	28 (18%)	12 (8%)
Type B	37 (24%)	21 (14%)	15 (10%)	12 (8%)
Type C	8 (5%)	16 (11%)	5 (3%)	1 (1%)
Type D	13 (9%)	4 (3%)	6 (4%)	4 (3%)
Type E	4 (3%)	6 (4%)	1 (1%)	3 (2%)
Type F	24 (16%)	17 (11%)	11 (7%)	5 (3%)
Type O	4 (3%)	1 (1%)	1 (1%)	2 (1%)

Type A: large, and broad – this was the most common fin shape.

Type B: long, thin, and pointed.

Type C: small, and triangular – the trailing edge was straight or perpendicular to the body.

Type D: the leading edge was bent posteriorly and/or the fin was very hooked.

Type E: short, low versions of Type A.

Type F: all have humps on the back of the whale anterior to the insertion of the dorsal fin.

Type O: all remaining fins – included whales with no fins or fins that were difficult to categorise.

Analysis of photographic catalogue for bias

We analysed both catalogued animals and rejected sightings to see what factors we used to identify individuals. Positive photo-identification depended on the presence of distinctive markings. Of the animals from the northern Gulf of Maine, 74% had some type of mark such as a nicked dorsal fin and/or a scar in addition to natural pigmentation (Table 1). Fin whales with non-distinctive (Type A) dorsal fins without nicks were rejected more than any other fin type. We required additional photographs of the chevron and/or scars to identify these as unique individuals, since the dorsal fins contained little information. Other factors which limited usefulness of photographs were absence of chevron, distance from observer and photographer errors such as poor focus, oblique camera angle and under- or over-exposure.

Stability of markings

We identified individual fin whales seen over a 14 year period in the COA collection and over a 10 year period in the Center for Coastal Studies (CCS) collection (southern Gulf of Maine). Evidence from these collections demonstrated that most of the natural markings used for individual identification remain stable over time. For example, Whale No. 0023 was first photographed at Mt Desert Rock in 1974. The distinguishing marks, a dent/crease down the middle of the back and a notch on the top of the dorsal fin, were still present in 1987. Whale No. 0006, first seen in the Bay of Fundy in 1978 and resighted there or at Mt Desert Rock during eight field seasons, also showed constancy of markings. Its dorsal fin shape and nicks remained unchanged for ten years. The CCS collection contained photographs of blaze and chevron patterns that remained stable for seven years (Clapham, 1987). No calves have been resighted in the northern Gulf of Maine and only one has been resighted in the CCS collection, so we were unable to determine whether markings change in the early years as has been reported for humpback whales (Carlson, Mayo and Whitehead, 1990).

Some whales obtained new markings during the study. Since we used more than one feature to distinguish an individual, we were able to confirm the identification. In 1986, Whale No. 0042 acquired a long scar on its left side, but its chevron pattern and dorsal fin shape remained the same. A more significant problem occurred when whales acquired nicks in previously unmarked dorsal fins. Whale No. 0020, first photographed in 1985 and classified as a smooth, Type A fin, had acquired a nick in the dorsal fin's trailing edge when photographed in 1986. Identification was confirmed by the overall dorsal fin shape and the chevron pattern.

Site fidelity

The following information was based on analysis of 151 individual fin whales photographed at Mt Desert Rock from 1974–1987.

Thirty-four percent of the animals in this area were resighted in more than one year. Beginning in 1983, we increased our efforts to photograph fin whales. The percentage of year-to-year resightings rose to 40% for the combined 1983–1987 data. Similar results have been found

Table 2

Numbers and percentages of identified individual fin whales and resightings.

Year	No. of individuals	No. (%) resights/year
Pre 1978	2	0 (0)
1978	5	0 (0)
1979	0	0 (0)
1980	2	1 (50)
1981	6	1 (17)
1982	15	4 (27)
1983	26	4 (15)
1984	24	10 (42)
1985	53	22 (42)
1986	64	32 (50)
1987	64	33 (52)

in the southern Gulf of Maine, where 45% of the 156 whales in the CCS collection were seen in more than one year (Seipt, pers. comm.). The highest return rate recorded for the Mt Desert Rock area occurred in 1987 when 52% of the whales documented were known individuals (Table 2).

Whales varied in the amount of time they spent in the study area. We photographed 61% of the animals on more than one day within a single field season. The longest single-season resident was Whale No. 0021, a female, who in 1985 was photographed on 28 days over an eight week period. In 1987, we sighted Whale No. 0140 on 17 days over seven weeks. Some individuals apparently left the area then returned and were re-photographed weeks later. Whale No. 0025 was photographed from 3–12 August, and then again 45 days later on 26 September. A similar pattern was found for the same animal in 1986, when it was photographed between 22 July and August 1, and then resighted on 26 August. In 1987, Whale No. 0024 was photographed four times, but three of the sightings were separated by almost a month (18 June, 18 July, and 11, 12 August). These whales were not sighted at other locations during their absences from Mt Desert Rock, so we have no information about their movements.

Movements within the Gulf of Maine

Of the 151 whales identified at Mt Desert Rock, 12% were resighted at other locations within the Gulf of Maine. Whale No. 0017, first seen near Provincetown, Massachusetts (southern Gulf of Maine) in 1982, was photographed at Mt Desert Rock in 1985 and 1986. This whale was also documented in the Bay of Fundy in 1986 and 1987. Whale No. 0002, a 1985 Mt Desert Rock visitor, was photographed in the Bay of Fundy during 1984 and 1986. These and other sightings (Table 3 and Fig. 7) demonstrate that individual fin whales moved throughout the Gulf of Maine.

Gender and reproduction

Gender was determined by photographs of genitalia or the presence of a calf. We photographed eleven females and one male in the Mt Desert Rock area. Three mother/calf pairs were sighted at Mt Desert Rock in 1985, 1986 and 1987, representing approximately 5% of the animals identified during each of those years.

Combined data from the northern and southern Gulf of Maine produced additional information on calving intervals (Table 4). Calving intervals ranged from 2–6

Table 3

Fin whale movements and resightings. M=Mt. Desert Rock, Maine; B=Bay of Fundy; S=Stellwagen Bank, Mass.; I=Seal Island, Maine; J=Jeffreys Ledge, Mass.; C=Cape Cod Bay, Mass.

Whale	Pre '78	78	79	80	81	82	83	84	85	86	87
0023	M	-	-	-	-	-	-	-	M	M	M
0052	M	-	-	M	-	I	M	M	-	-	-
0006	-	B	-	-	B	B	-	M	MB	B	MB
0064	-	-	-	-	-	-	-	M	M	M	-
0018	-	-	-	M	-	-	-	M	M	M	M
0069	-	-	-	S	CS	S	S	S	-	-	SJ
0001	-	-	-	-	M	M	-	-	M	M	M
0005	-	-	-	-	M	-	-	-	M	M	M
0025	-	-	-	-	M	-	-	-	M	M	M
0068	-	-	-	-	S	-	-	-	-	S	-
0017	-	-	-	-	-	S	S	-	MB	MB	B
0071	-	-	-	-	-	J	M	JS	J	JS	S
0013	-	-	-	-	-	I	-	-	M	M	M
0021	-	-	-	-	-	I	-	-	M	M	M
0022	-	-	-	-	-	M	-	-	M	M	-
0079	-	-	-	-	-	M	-	-	-	M	M
0015	-	-	-	-	-	-	MI	M	M	M	-
0029	-	-	-	-	-	-	M	M	M	M	-
0026	-	-	-	-	-	-	M	M	M	-	M
0083	-	-	-	-	-	-	MI	M	-	M	M
0092	-	-	-	-	-	-	MI	M	-	-	M
0091	-	-	-	-	-	-	M	M	-	-	-
0045	-	-	-	-	-	-	B	-	M	M	M
0070	-	-	-	-	-	-	M	-	M	-	-
0007	-	-	-	-	-	-	M	-	M	-	-
0085	-	-	-	-	-	-	IB	-	-	M	-
0088	-	-	-	-	-	-	M	-	-	M	-
0090	-	-	-	-	-	-	MB	-	-	-	M
0093	-	-	-	-	-	-	MI	-	-	-	-
0032	-	-	-	-	-	-	-	M	M	M	M
0102	-	-	-	-	-	-	-	M	M	M	M
0002	-	-	-	-	-	-	-	B	M	B	-
0050	-	-	-	-	-	-	-	M	M	-	M
0101	-	-	-	-	-	-	M	-	-	M	-
0099	-	-	-	-	-	-	-	M	-	-	M
0009	-	-	-	-	-	-	-	-	M	M	M
0039	-	-	-	-	-	-	-	-	M	M	M
0042	-	-	-	-	-	-	-	-	M	M	M
0020	-	-	-	-	-	-	-	-	M	M	-
0030	-	-	-	-	-	-	-	-	M	M	-
0033	-	-	-	-	-	-	-	-	M	M	-
0040	-	-	-	-	-	-	-	-	M	M	-
0044	-	-	-	-	-	-	-	-	M	M	-
0024	-	-	-	-	-	-	-	-	MB	-	M
0027	-	-	-	-	-	-	-	-	M	-	M
0038	-	-	-	-	-	-	-	-	M	-	M
0073	-	-	-	-	-	-	-	-	-	M	M
0116	-	-	-	-	-	-	S	-	-	M	M
0119	-	-	-	-	-	-	-	-	-	M	M
0131	-	-	-	-	-	-	-	-	-	B	M
0137	-	-	-	-	-	-	-	-	-	M	M
0140	-	-	-	-	-	-	-	-	-	M	M
0144	-	-	-	-	-	-	-	-	-	M	M
0120	-	-	-	-	-	-	-	-	-	MB	-

years, but females were often not seen during the intervening years. We sighted two females, Whale Nos 2025 and 1079, during each year of a four-year calving period. Females No. 2003 and No. 0071 had two-year calving intervals. Whale No. 0071 was also sighted in 1985 with a calf, but no photographs were taken. Three other females were photographed with a calf at four-year intervals and one with a six-year interval, but these animals were not photographed during the intervening years, so the calving interval may have been less.

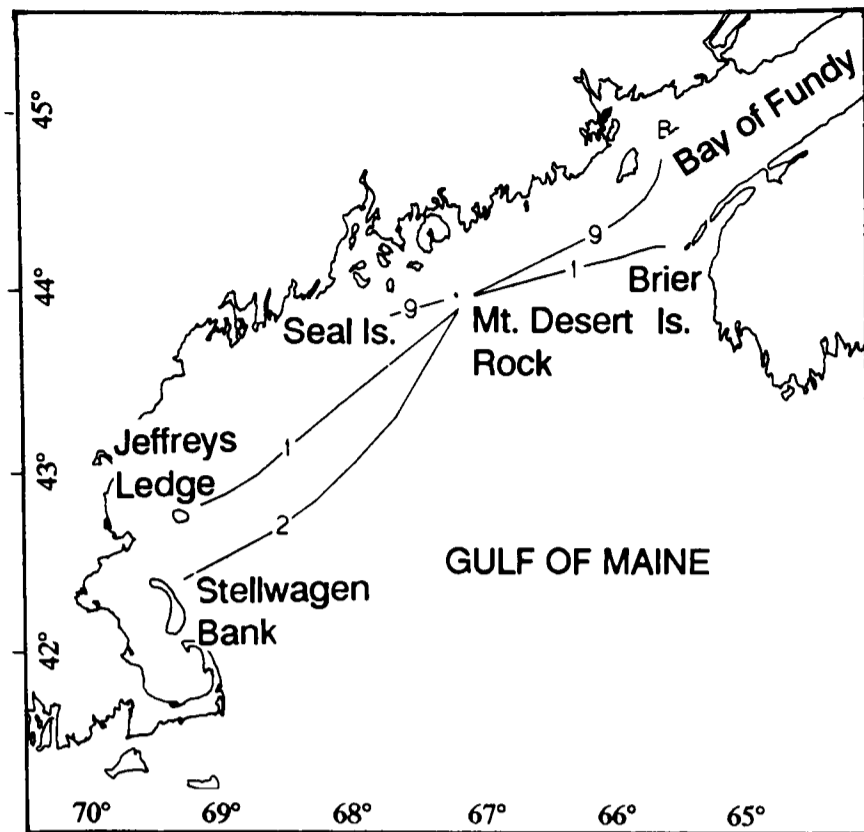

Fig. 7. Map of the Gulf of Maine showing the movements of individual fin whales. Numbers on lines indicate number of whales matched between areas.

Table 4

Calving history of individually identified fin whales. Years when individually identified fin whales were observed with a calf (C), without a calf (O), and (*) seen with calf but no photographs obtained

Whale	78	79	80	81	82	83	84	85	86	87
0011	-	-	-	-	-	-	-	C	-	-
0021	-	-	-	-	O	-	-	O	C	O
0030	-	-	-	-	-	-	-	C	O	-
0036	-	-	-	-	-	-	-	C	-	-
0061	C	-	-	-	-	-	-	-	-	-
0069	-	-	O	O	C	O	O	-	-	O
0071	-	-	-	-	C	O	C	C*	C	O
0073	-	-	-	-	-	-	-	-	C	O
0092	-	-	-	-	-	C	O	-	-	C
0101	-	-	-	-	-	-	O	-	C	-
0116	-	-	-	-	-	C	-	-	O	C
0172	-	-	-	-	-	-	-	-	-	C
1068	-	-	C	-	-	-	O	-	C	-
1079	-	O	O	O	C	O	O	O	C	C
2003	-	-	-	C	-	C	-	-	O	O
2025	-	-	-	C	O	O	O	C	-	O
2174	-	-	-	C	O	-	O	C	-	-

DISCUSSION

Our results indicate that photo-identification is an effective method for studying the movements and life histories of individual fin whales. The characteristics used to identify individuals, including dorsal fin shape, pigmentation pattern, and scar shape and location, were sufficiently stable to permit re-identification over periods of at least 14 years.

Fin whales from Newfoundland to New York, the range for which we have photographs, possessed the morphological characteristics we used for individual identification. Although pigmentation patterns of fin whales in the Gulf of California were more difficult to observe, these whales have been studied using methods similar to ours (Tershy, Breese and Strong, 1990; L. Findlay, pers. comm.). There has been discussion that not all fin whales have a prominent blaze/chevron pattern such

as that found in the western North Atlantic (W. Watkins, pers. comm.). Animals summering off West Greenland are also more difficult to identify (P. Clapham, pers. comm.). Thus comparable photographs from other fin whale stocks are needed to ascertain whether our techniques have applicability in other areas.

If the photo-identification method described here is applicable to fin whales throughout the North Atlantic, it could contribute to basic knowledge of fin whale life history and demographics. For example, further information is needed about the stock structure of fin whales in the western North Atlantic. Our results suggest that a substantial number of fin whales returned to the Gulf of Maine regularly and may constitute a feeding aggregation. The identification method described here will contribute to a better understanding of the geographic limits, migrations and discreteness of fin whale populations. In the future, we can test hypotheses such as the one presented by Mitchell (1974) on the basis of Discovery-tagging studies carried out from 1967-71.

As the photographic collection grows, known-age animals will become available for necropsy examination, offering an opportunity to verify anatomical methods for estimating age and increasing the reliability of data from hunted specimens (Aguilar, Olmos and Lockyer, 1988).

Current study efforts have concentrated on local populations that consist of a few hundred animals. Extension of the North Atlantic Finback Whale Catalogue to include photographs from other regions has led us to consider whether fin whale markings contain enough information to allow unambiguous identification of individuals from a larger population. Payne, Brazier, Dorsey, Perkins, Rowntree and Titus (1983) quantified the information content of callosity patterns for southern right whales and calculated the possibility that two individuals might have identical patterns. We feel that quantitative analysis of fin whale markings is impractical at this time. Nevertheless, we feel that the application of photo-identification techniques to fin whales is an important and useful tool. It will ultimately yield insights into migrations and behavior that can only be gained from free-ranging whales.

ACKNOWLEDGEMENTS

We thank the many researchers and organisations from the North Atlantic ocean who have contributed to this collaborative project. In addition to those listed in the text, we thank Maine Whalewatch, Northeast Harbor, Maine; New England Whale Watch, Newburyport, Massachusetts; New Hampshire Seacoast Cruises, Rye New Hampshire; and North Atlantic Marine Mammal Association, Provincetown, Massachusetts; Steve Arthur; Lisa Baraff; Tim Cole; David James; Alan Mainwaring; Scott Marion; Gale McCullough; Megan McOsker; Steve Mullane; Susi Newborn; Ann Rivers; Kim Robertson; Greg Stone; Scott Swann; Wendy Van Dyke; and Fred Wenzel. We are grateful to Eleanor Dorsey, Center for Long Term Research, 191 Weston Road, Lincoln, Massachusetts and Gordon Waring, National Marine Fisheries Service, Northeast Fisheries Center, Woods Hole, Massachusetts for review of this manuscript.

For support of this project, we thank the Endangered and Nongame Wildlife Grants Program of the Maine Department of Inland Fisheries and Wildlife; the Island Foundations, Inc.; the Windstar Foundation; and the

South Branch Foundation. We also thank the many individuals who have adopted whales through COA's "Adopt a Finback Whale" programme, whose proceeds support this research. The United States Coast Guard, Southwest Harbor Group, deserves special thanks for their continued assistance and permission to use the facilities at Mt Desert Rock.

REFERENCES

- Agler, B.A. and Katona, S.K. 1987. Photo-identification of finback whales. *Whalewatcher* 21:36-8.
- Aguilar, A., Olmos, M. and Lockyer, C.H. 1988. Sexual maturity in fin whales (*Balaenoptera physalus*) caught off Spain. *Rep. int. Whal. Commn* 38:317-22.
- Allen, G.M. 1916. The whalebone whales of New England. *Mem. Boston Soc. Nat. Hist.* 8(2):107-322.
- Braham, H.W. 1984. The status of endangered whales: an overview. *Mar. Fish. Rev.* 46:2-6.
- Carlson, C.A., Mayo, C.A. and Whitehead, H. 1990. Changes in the ventral fluke patterns of the humpback whale (*Megaptera novaeangliae*) and its affect on matching: evaluation of its significance to photo-identification research. Paper SC/A88/ID35 (published in this volume).
- Clapham, P.J. (ed.) 1987. North Atlantic fin whale research: Proceedings of a meeting to review methodology and to coordinate information exchange. 24 October 1986. Available from: North Atlantic Marine Mammal Association, Center for Coastal Studies, Provincetown, Massachusetts. 26pp.
- Gambell, R. 1985. Fin whale, *Balaenoptera physalus* (Linnaeus, 1758). pp. 171-192. In: Ridgway, S.H. and Harrison, R. (eds.), *Handbook of Marine Mammals, Volume 3: The Sirenians and Baleen Whales*. Academic Press, London. 362pp.
- International Whaling Commission. 1990. Report of the Workshop on Individual Recognition and the Estimation of Cetacean Population Parameters. (Published in this volume).
- Leatherwood, S., Caldwell, D.K. and Winn, H.E. 1976. Whales, dolphins and porpoises of the western North Atlantic: a guide to their identification. NOAA Technical Report, NMFS CIRC-396.
- Mattila, D.K., Carlson, C.A., Clapham, P.J. and Mayo, C.A. 1983. Resightings of individually identifiable fin whales in the waters of Stellwagen Bank and Cape Cod Bay, Massachusetts. Abstracts presented to the Fifth Biennial Conference on the Biology of Marine Mammals. Nov. 27-Dec. 1, 1983, Boston, MA.(unpublished).
- Mitchell, E.D. 1972. Balaenopterine or finner whales. pp. 24-9. In: Seed, A. (ed.), *Baleen Whales: in Eastern North Pacific and Arctic Waters*. Pacific Search Press, Seattle.
- Mitchell, E.D. 1974. Present status of northwest Atlantic fin and other whale stocks. pp. 108-69 In: Schevill, W.E. (ed.), *The Whale Problem: a status report*. Harvard Univ. Press, Cambridge. 419pp.
- Payne, R., Brazier, O., Dorsey, E.M., Perkins, J.S., Rowntree, V.J. and Titus, A. 1983. External features in southern right whales (*Eubalaena australis*) and their use in identifying individuals. pp.371-445 In: Payne, R. (ed.), *Communication and Behavior of Whales*. AAAS Selected Symposium No. 76. Boulder, Colorado. 643pp.
- Tershy, B., Breese, D. and Strong, S. 1990. Abundance, seasonal distribution and population composition of Balaenopterid whales in the Canal de Ballenas, Gulf of California, Mexico. Paper SC/A88/ID22 (published in this volume).
- True, F.W. 1904. The whalebone whales of the western North Atlantic. *Smithson. Contrib. Knowl.* 33:1-332.

Minke Whales (*Balaenoptera acutorostrata*) from the West Coast of North America: Individual Recognition and Small-Scale Site Fidelity

Eleanor M. Dorsey¹, S. Jonathan Stern², A. Rus Hoelzel³ and Jeff Jacobsen⁴

ABSTRACT

A total of 55 individual minke whales were recognized on 444 occasions from close-up photographs taken in three study sites along the west coast of North America: Monterey Bay in central California; the San Juan Islands in northern Washington; and the Johnstone Strait area of northern Vancouver Island, British Columbia. The studies spanned 4, 11 and 7 years, respectively, and 31 individuals (56%) were seen in two or more years. Naturally occurring features that were useful for individual identification (dorsal fin, small oval scars, and lateral body pigmentation) either were constant over the time observed or changed slowly enough to allow re-identifications spanning up to 11 years. No individual was seen in more than one study site and many individuals were seen year after year in the same study site in summer and early fall. In the two sites where intensive observations were made (Monterey Bay and San Juan Islands), most minke whales were sighted in only one of two or three separate ranges. This small-scale spatial partitioning may be related to specialized foraging strategies of individuals.

INTRODUCTION

Considerable information about minke whales, *Balaenoptera acutorostrata*, has been obtained from the study of dead animals provided by commercial whaling (e.g. Jonsgård, 1951; Omura and Sakiura, 1956; Williamson, 1975; Best, 1982;1985), but very few studies of free-ranging minke whales have been conducted, with the exception of sightings cruises (e.g. Best and Butterworth, 1980; Butterworth and Best, 1982). In 1980, we started intensive observations of free-ranging minke whales during summer months in Washington state in a behavioral study based on the recognition of individual animals. Sixteen individuals were identified in 1980, and they appeared to partition the study area into three exclusive ranges (Dorsey, 1983). We have continued that study and expanded it to include two additional study sites, one in central California and one in northern Vancouver Island. We report here results from photo-identification of minke whales through 1987 from these three sites.

METHODS

The three study sites (Fig. 1) were: (1) the San Juan Islands, Washington (including some adjacent Canadian waters); (2) Monterey Bay in central California and adjacent coast to the south; and (3) the inland waters of southern British Columbia including the western end of Johnstone Strait, the eastern end of Queen Charlotte Strait and adjacent inlets (referred to here as the Johnstone Strait area). Table 1 provides a comparison of the three study sites with respect to latitude, topography, usual sea conditions, and years in which intensive research and incidental observations were made. The San Juan Islands and the Johnstone Strait area are similar in being protected

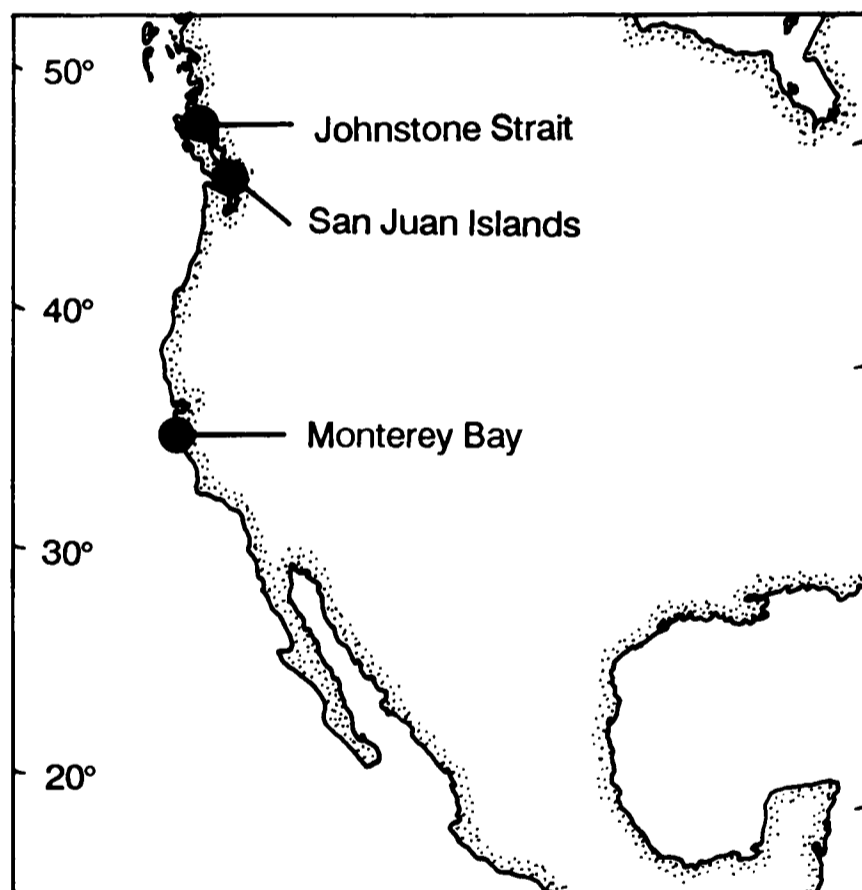

Fig. 1. Location of the three study sites along the west coast of North America.

inland waters with frequent calm conditions; the Monterey Bay area is exposed outer coast with consistently rougher waters.

Intensive research on minke whales was conducted in the Monterey Bay area from 1984 through 1987, and in the San Juan Islands from 1980 through 1984. Most observations were made from June through September (Table 2). Supplemental photographs taken opportunistically by researchers studying other cetaceans were available from the San Juan Islands in most years from 1977–87. In the Johnstone Strait area, photographs were obtained from 1981–87, and most were taken incidentally to the study of killer whales (*Orcinus orca*). All observations were made during daylight hours, except for one encounter in the San Juan Islands.

¹ Long Term Research Institute, 191 Weston Road, Lincoln, MA 01773, USA. Current address: Conservation Law Foundation, 3 Joy St., Boston, MA 02108, USA.

² Department of Biology, San Francisco State University, 1600 Holloway Ave., San Francisco, CA 94132, USA.

³ Department of Genetics, Cambridge University, Downing St., Cambridge, CB2 3EH, UK.

⁴ Department of Biological Sciences, Humboldt State University, Arcata, CA 95521, USA.

Table 1

Comparison of the three study sites with respect to latitude, topography, usual sea conditions, and effort by year. The usual sea conditions are from our personal observations during this study and are reported as sea state (ss) on the Beaufort scale and swell height (sw) in feet.

	Monterey Bay	San Juan Is.	Johnstone Str.
Latitude N.	36°17'-36°36'	48°19'-48°48'	50°29'-50°49'
Topography	exposed outer coast	inland waters	inland waters
Usual sea condit.	ss 3, sw 3-4	ss 0-2, sw 0-1	ss 0-2, sw 0-1
Yrs of intensive research	1984-87	1980-84	—
Yrs of incidental sightings only	—	1977-78, 1985-87	1981-87
Most data collected by	SJS	EMD, ARH SJS	JJ

Table 2

Duration of field observations for the years of intensive research in the San Juan Islands in 1982. In range C, only the northern feeding area is considered because the southern feeding area was searched too infrequently. See Fig. 2 for the locations of the ranges and the feeding areas.

	San Juan Islands				
	1980	1981	1982	1983	1984
Start	19 Jun	24 Jun	9 Apr	20 Jun	28 Jun
End	23 Oct	25 Aug	20 Oct	11 Sep	26 Aug

	Monterey Bay Area			
	1984	1985	1986	1987
Start	30 May	9 Jun	24 Jul	31 Jul
End	10 Jun	30 Aug	30 Sep	30 Sep

Most photographs were taken from small (about 5m) outboard motor boats, which provided the speed and manoeuvrability needed to get into position for close-up, broadside photographs. Several different SLR cameras were used with telephoto lenses, usually 300mm or 80–200mm zoom; the former lens gave better resolution for distant whales. A motor drive or power winder on the camera allowed multiple frames of a single surfacing. The preferred film was *Ilford* HP-5 (400 ASA) exposed at a shutter speed of at least 1/500s, but other black and white films, color slide films, and color print films were occasionally used, and these also provided photographs suitable for individual recognition. Handwritten field notes, usually on prepared forms, and 'blank' frames taken of non-whale subjects were used to separate different individuals and to allow the grouping of multiple photographs of the same individual. Locations on the water were determined by taking bearings to landmarks with a hand-held sighting compass. In the San Juan Islands, there were usually three people in the boat (one to drive, one to take photographs, and one to take notes) but in the Monterey Bay area, a single person performed all of these functions.

In the San Juan Islands we were based in Friday Harbor, and in the Monterey Bay area we were based in Pacific Grove. Our sampling strategy was usually to go to areas where minke whales were likely to be found. Individual whales were followed as focal animals for variable lengths of time, with priority placed initially on obtaining good photographs and subsequently on making observations of behavior. Attempts were made to identify all animals observed in an area and to search all areas of minke whale concentration as often as weather permitted. (However, we did not often visit the southernmost area of concentration in the San Juan Islands except in 1984, and we did not search south of Carmel Bay in the Monterey Bay area in 1984). Searches for minke whales outside the areas of concentration were rarely made.

Analysis of photographs for identification of individual animals was facilitated by printing the images of the whales on paper measuring about 8cm by 17cm. Because of the geographical separation of the authors, it was not possible to have a second person check all identifications; to compensate for this, identifications were made conservatively. A whale was considered either identified or not. If there was uncertainty, the whale was called unidentified. Individual whales were given identification numbers starting with a letter to denote area (S for San Juan Islands, M for Monterey Bay, J for Johnstone Strait) followed by a number; numbering started at 1 for each site. The photographic collection from the San Juan Islands and the Johnstone Strait area is held by EMD and the collection from Monterey Bay is held by SJS.

We quantified the identifiability of photographed whales in the following manner. We used the 'blank' frames (taken when we moved to a different individual or when we were no longer certain that we were with the same individual) to separate and define photographic encounters. Then we calculated the percentage of photographic encounters in which the whale was definitely identified. In the San Juan Islands we excluded photographs taken with lenses smaller than 300mm, but in the Monterey Bay area all photographs were taken with a 80–200mm zoom lens, almost always set at 200mm.

RESULTS

General observations

In the San Juan Islands, minke whales were found most reliably in four separate feeding areas (Fig. 2). Within these feeding areas, whales would mill around for hours at a time, occasionally feeding at the surface on small schooling fish. We observed 282 definite instances of feeding in 1980–84. Two distinct types of foraging were observed (feeding under flocks of feeding seabirds and lunge feeding without seabirds) and individuals tended to specialize on one of these types (Hoelzel, Dorsey and Stern, 1989). The prey taken included juvenile herring (*Clupea harengus*) and probably sand lance (*Ammodytes hexapterus*). Up to six whales at a time were observed in a feeding area, but the whales usually acted independently, with no indications of cooperative feeding. Occasionally two whales would surface at the same time within 1–2 body lengths. The duration of these associations varied from just one surfacing to about 90 minutes. On one occasion three whales were seen together for a few surfacings. No other social interactions were apparent and no mother-calf pairs were observed. Sizes were not known for any individuals. Outside of the feeding areas, whales usually traveled in

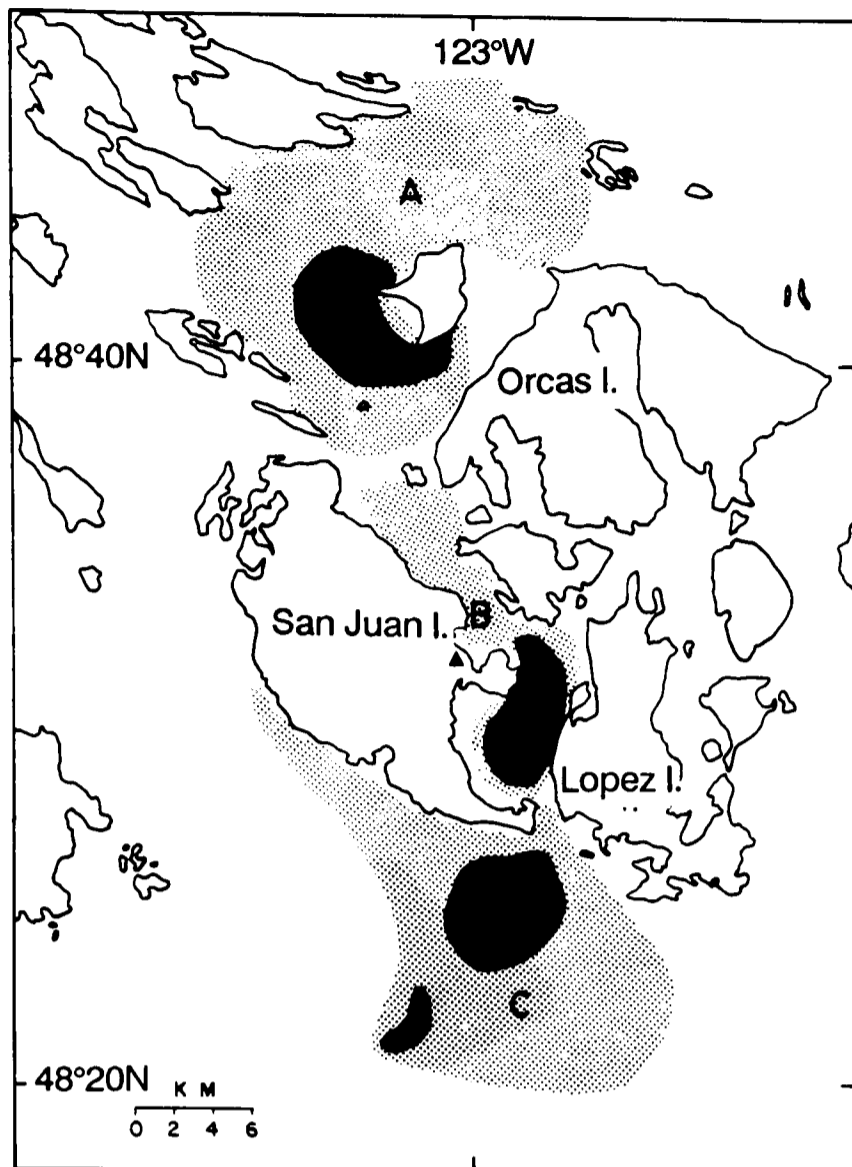

Fig. 2. The San Juan Islands study site, showing locations of the three separate ranges (light stippling) and four feeding areas (dark stippling).

more or less straight paths, in contrast to the milling typical inside the feeding areas. It was possible to follow some whales for almost seven hours and almost 20km. Only one close pass was observed with local killer whales, a potential predator on minke whales: a minke whale passed within a body length of a mature male killer whale from a resident pod with no apparent reaction from either animal. Usually minke whales did not occur near the local killer whales in the study area.

In the Monterey Bay area, minke whales were found within about 3km of the coast, occasionally just outside the band of kelp parallel to the shoreline at about 3m depth. Most of the time minke whales were moving in a more or less straight line along the coast with no milling, a striking contrast to the typical behavior in the San Juan Islands. There were almost no signs of feeding visible from the surface: once a minke whale was seen just under the surface engulfing a small dense school of baitfish; and three times seabirds were observed picking up baitfish in the spot where a minke whale had just made a vigorous surfacing. Anchovy (*Engraulis mordax*) is abundant in the area and may have been the prey. Interactions between individuals were limited to four instances of two whales swimming together. No mother-calf pairs were seen. Usually only one whale was in view at a time. The length of one unusually small whale that swam very close to the boat was estimated to be 4.3m. In this area, it was possible to follow individual minke whales for up to two hours.

In the Johnstone Strait area, minke whales were typically seen milling in locations of strong tidal currents, possibly feeding well underwater. Whales were also observed feeding at or near the surface on dense schools of

herring under flocks of feeding seabirds. On three occasions a whale passed repeatedly through a large herring school for about 0.5–2.0 hours. One of these feeding bouts was observed from underwater, and the herring school became progressively smaller (Flip Nicklin, pers. comm.). Pairs and trios of minke whales were seen surfacing together briefly on several occasions, but no mother-calf pairs were seen. Both resident and transient killer whales (Bigg, 1982; Bigg *et al.*, 1990) frequently traveled through and foraged in areas where minke whales were seen, in contrast to the San Juan Islands. Minke whale responses to resident killer whales varied from no apparent change in behavior, even when the minke whale surfaced among several small groups of slowly traveling killer whales, to breaching eight times or more in rapid succession as foraging killer whales approached (Jacobsen, 1986). Minke whales were seen in the vicinity of traveling transient killer whales on two occasions with no apparent change in behavior by either species. A scar that is probably from a killer whale tooth rake was observed on one minke whale (Fig. 3A) and suggests that interactions between the two species are not always benign.

Although we have not looked for minke whales in late fall, winter or early spring in any of these studies, we believe that the numbers are greatly reduced at these times compared to summer and early fall. Our best data on seasonal trends are from the San Juan Islands in 1982, when we were looking for minke whales from April through October. The sighting rate was very low in April and May, higher in June, and highest in July and August,

Table 3

Monthly sighting effort and sighting rate for the feeding area in each range in the San Juan Islands in 1982. In range C, only the northern feeding area is considered because the southern feeding area was searched too infrequently. See Fig. 2 for the locations of the ranges and the feeding areas.

ID No.	'77	'78	'80	'81	'82	'83	'84	'85	'86	'87	Total sightings	Total years
S1			12	6	4	3	9				34	5
S2	1	2	6	6	4	3	13	1	1		14	7
S3		2	2	1	1		6	1	1		14	7
S4			5	5	10						20	3
S5		1	7	6	3	7	1	2	1		28	8
S6		1	7	8	8	3	2			1	30	7
S7	1		4	4	8	4	1			1	23	7
S8	1		4	3	12	1	3				24	6
S9		1	1	2	1		1				6	5
S10			3	1	8	7	2				21	5
S11				3	1						4	2
S12			3								3	1
S13			1		4	4	3				12	4
S14			1								1	1
S15			1	2	2	1	3				9	5
S16			6	5	3	1	3				18	5
S17				6	7	3			2	1	19	5
S18					2	1					3	2
S19					6						6	1
S20					2	1					3	2
S21					1						1	1
S22				1							1	1
S23						4	1				5	2
S24						2					2	1
S25						1	1				2	2
S26						1	11	2	2		16	4
S27								1			1	1
S28							10				10	1
S29							1				1	1
S30										1	1	1

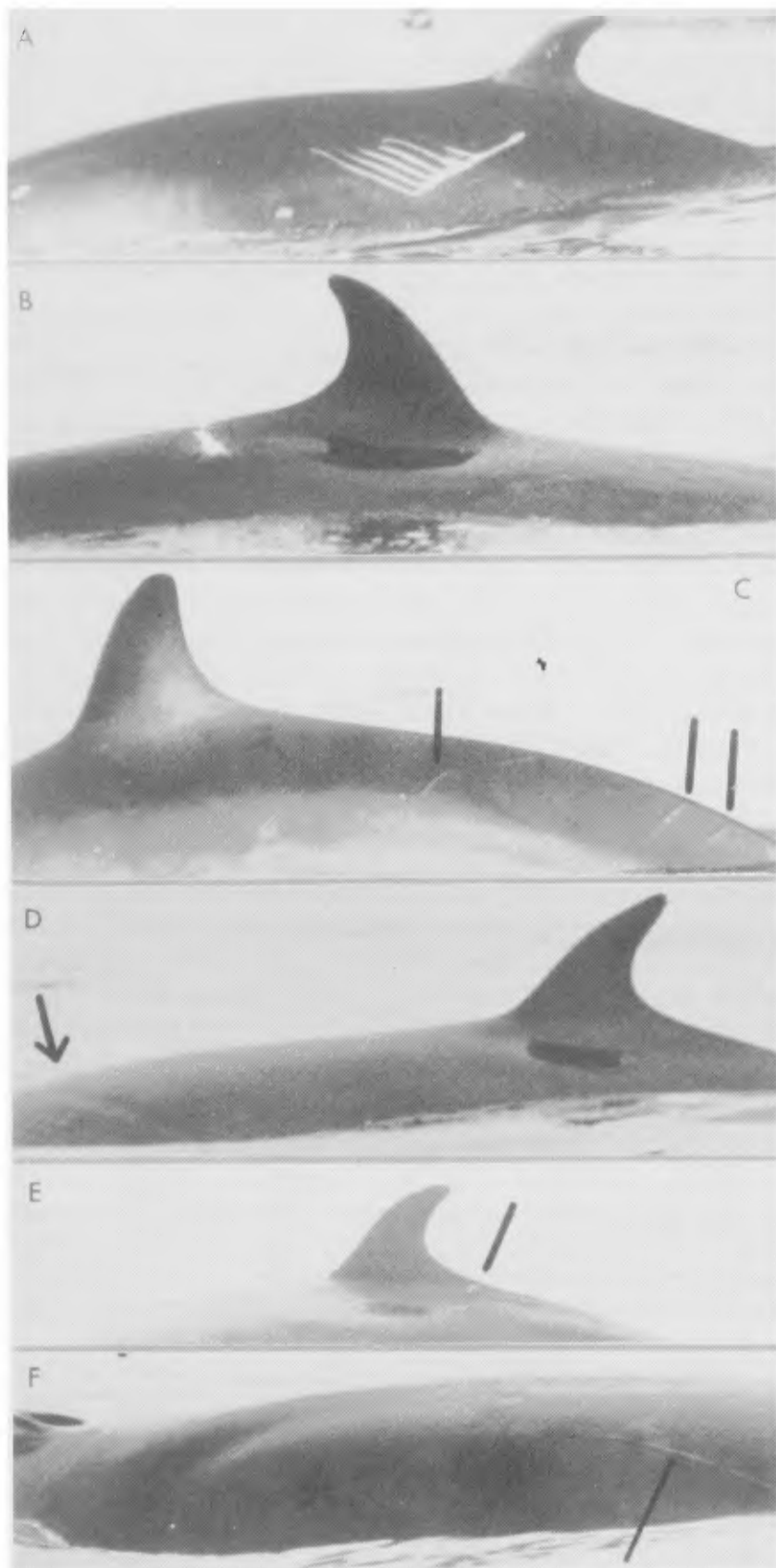

Fig. 3. Miscellaneous distinctive features. A. Large scar, probably a killer whale tooth rake (whale J7). B. Scar behind dorsal fin (whale M6). C. Raised welts on tail stock (whale S26). D. Narrow depression in skin (whale M12). E. Small raised bump behind fin (whale M3). F. Thin scratch (whale S26).

with some tapering off in September and October (Table 3). In other years when we looked in June, our impression was that fewer whales were present than in July and August. Sightings of minke whales in inland Washington waters are very low in winter months (Everitt, Fiscus and DeLong, 1979; Richard Osborne, pers. comm.), in part, no doubt, because of poor weather and low search effort. In the Monterey Bay area, a few minke whales are sighted in winter (Marilyn Dalheim, pers. comm.; James Bird, pers. comm.), but sightings increase toward the end of May and are highest in July–September (Alan Baldrige, pers. comm.). In the Johnstone Strait area also, winter sightings are lower than in summer and early fall, although sighting effort is lower in winter (Alexandra Morton, Paul Spong, Bill McKay, pers. comm.).

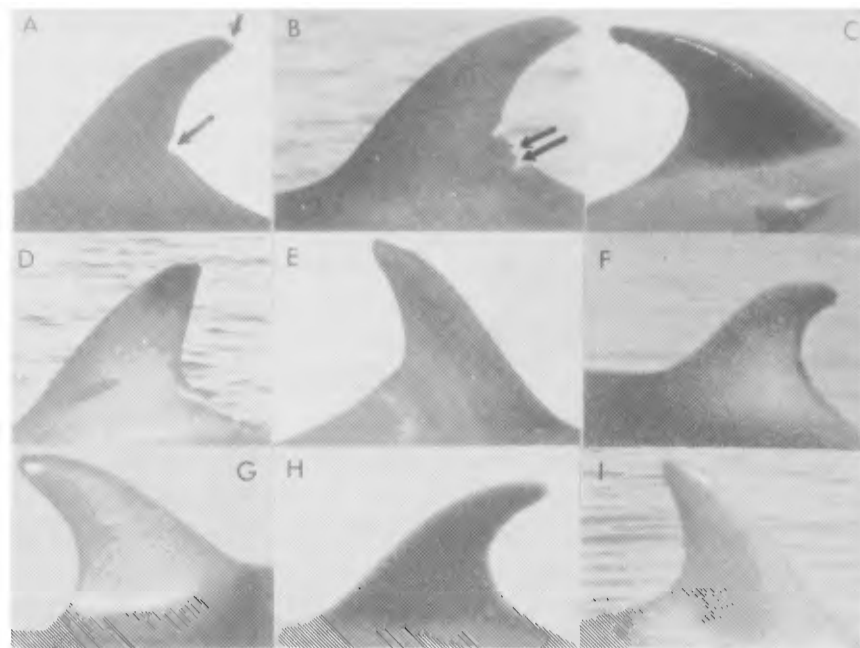

Fig. 4. A selection of dorsal fins. A. Two nicks in fin of whale S16 in 1981. B. Two additional nicks in fin of whale S16 in 1984. C. Irregular trailing edge, whale S20. D. Dark line on pale fin and straight trailing edge, whale S7. E. Scalloping on leading edge near tip and pale pigmentation, whale S10. See also Fig. 5A. F. Pale wash, whale S11. G. Two small welts, whale S18. H. Undistinctive fin with long curve, whale S3. I. Undistinctive triangular fin, whale S28.

Individually distinctive features

Three main features are useful for recognition of individuals – the dorsal fin, small oval scars and lateral body pigmentation. Several other miscellaneous markings and scars occur at low frequency. Most of these features are described by Dorsey (1983), but we will present here more extensive illustrations and information about constancy over time. Our observations are based on photographs of 55 different individuals from the three study areas, spanning up to 11 years. Joyce and Dorsey (1990) briefly compare identifying features from these study areas with those for Southern Hemisphere minke whales.

Dorsal fins

A broadside view of the dorsal fin alone is distinctive enough for individual identification in about 40% of individuals. The profile of the fin may be distinctive due to nicks (Figs 4A, 4B) or other unusual shapes (irregular trailing edge – Fig. 4C; vertical trailing edge – Fig. 4D; scalloping on leading edge near the tip – Fig. 4E). Some fins have contrasting pigmentation such as the pale wash in Fig. 4F, the dark line on a pale wash in Fig. 4D and the pale strips in Fig. 4E. Two fins have been seen with small welts (Fig. 4G). A few fins have been observed to tilt consistently to one side.

When no unusual features are present on the fin, its general shape is classified as a short curve (Fig. 4G), a long curve (Fig. 4H) or triangular (Fig. 4I). This classification provides an initial sorting to narrow the field of possible matches.

No change over time has been observed in dorsal fins with one exception: whale S16 had one medium and one small nick in its fin from 1980 to 1983 (Fig. 4A) but in 1984 had an additional medium nick and an additional small nick (Fig. 4B). We do not know the cause of the nicks. The distinctive dark line in the fin of whale S7 (Fig. 4D) remained unchanged from 1980 through 1987 and the pale lines on the fin of whale S10 (Fig. 4E) remained unchanged at least from 1980 through 1983.

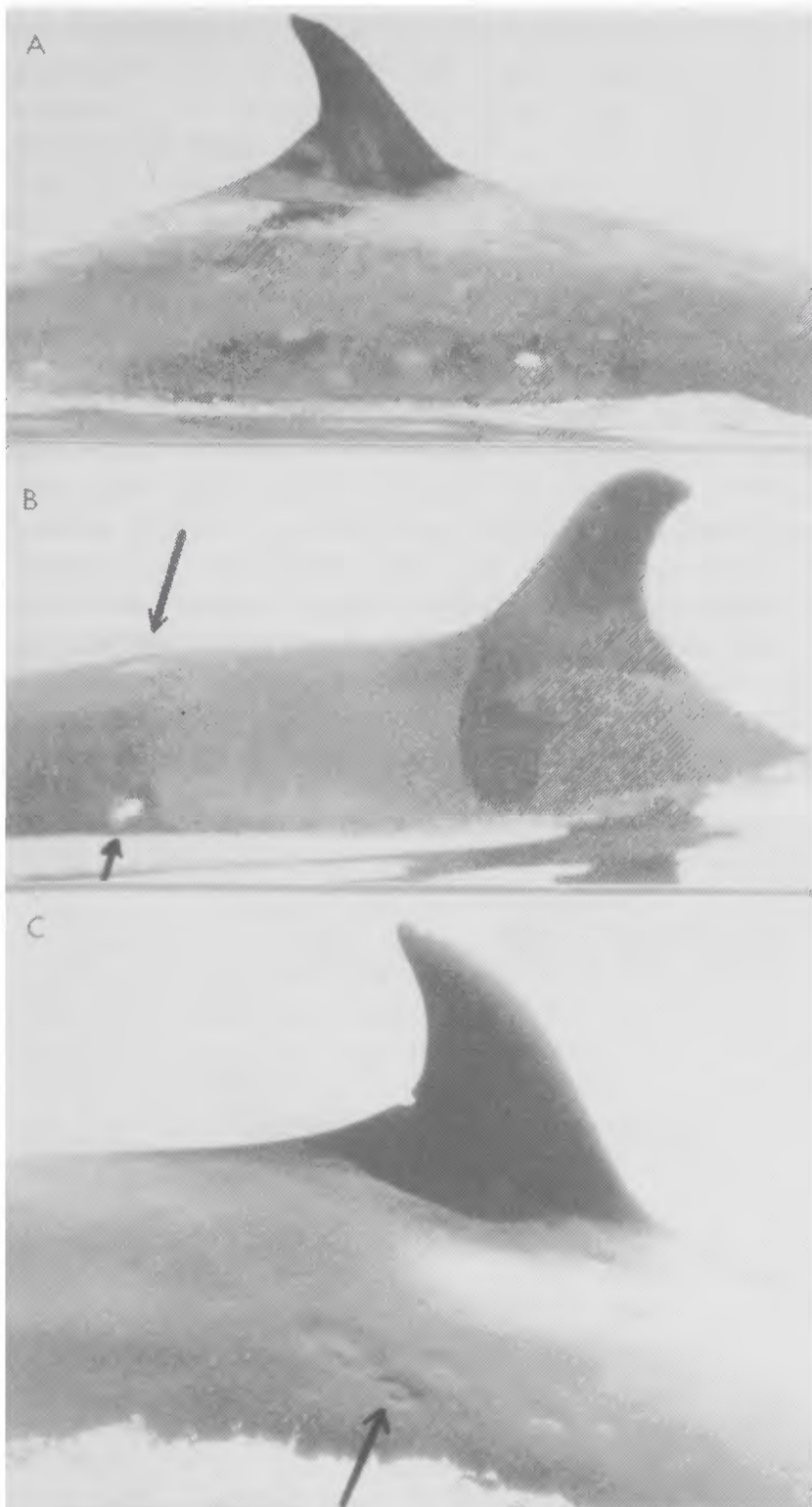

Fig. 5. Illustrations of small oval scars. A. An example of a heavily scarred individual, whale S10. B. Whale S6 in 1984 with a new scar that year (lower scar) and a scar that was new in 1980 (upper scar). C. An example of a very old oval scar (whale S4).

Small oval scars

Most whales have from a few to dozens of small oval scars on each side of the body, on the flank and dorsum visible above water during a normal surfacing. Dorsey (1983) describes these scars as circular, but closer examination of the photographs reveals that they are, in fact, oval in shape with the long axis of the oval almost always parallel to the longitudinal axis of the whale. One such scar measured from a minke whale that stranded in Pescadero Beach, CA in June, 1984 was about 5cm by 3cm. The depth of the scar was not measured, but was probably not greater than 5mm. These small scars are very useful for recognition of individuals.

Fig. 5A illustrates a heavily scarred individual. Most minke whales acquire one to several new scars each year on the part of the body that we regularly photograph. New scars are highly visible even in distant and poor quality photographs because they are bright white in contrast to the dark body pigmentation. By one year later, the color of the scars is noticeably less bright and over the next several years the contrasting color fades. See Fig. 5B for an example of a new white scar and a scar that was new and

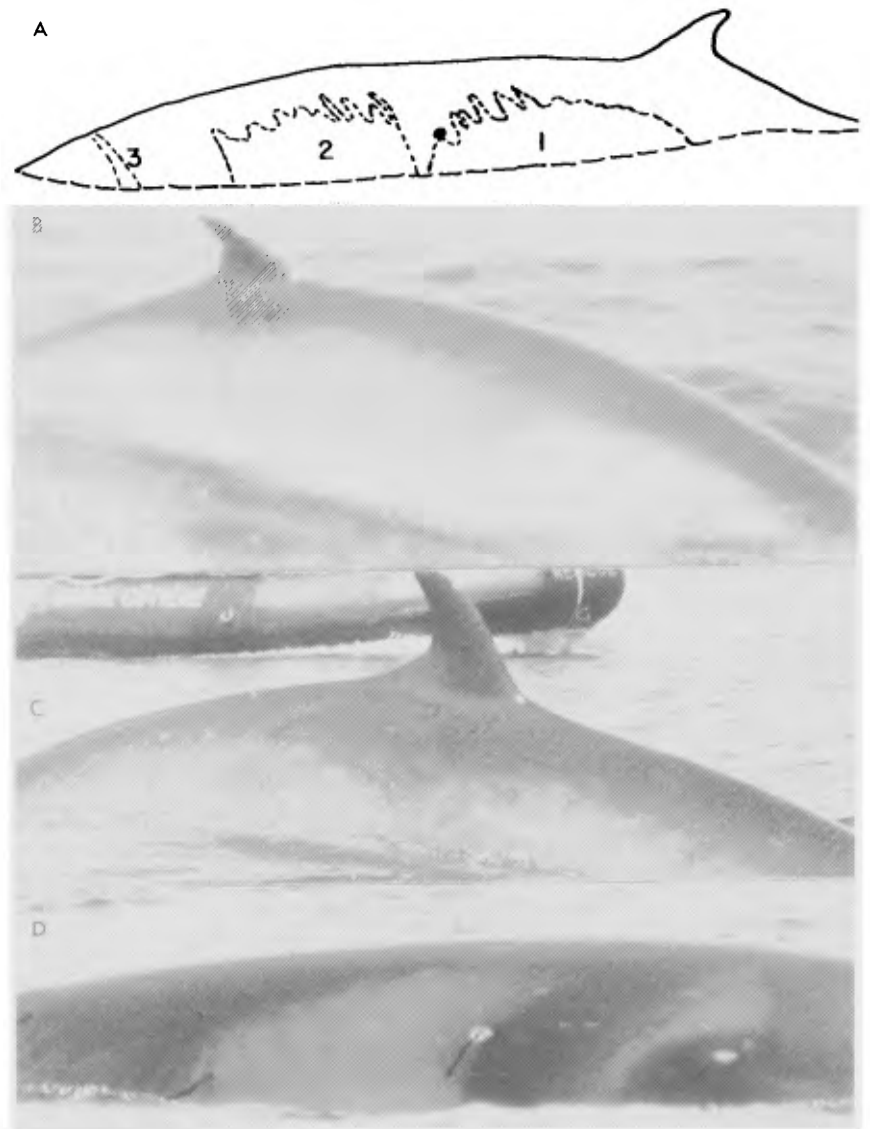

Fig. 6. Lateral body pigmentation used for recognition of individuals. A. Diagram of the three swaths, traced from whale S2. 1 = flank patch, 2 = thorax patch, 3 = shoulder streak. B. Flank and thorax patches on a minke whale from the western North Atlantic. C. An unusually distinctive flank patch (whale J3). D. Right thorax patch and shoulder streak on whale S4. The dark lines are *Pennella*.

white four years earlier. Eventually, the scar becomes completely repigmented to the color of the surrounding skin, but the scar contour, a small depression in the skin with the perimeter slightly deeper than the center, appears to be permanent (Fig. 5C). These very old scars are usually not visible in poor quality photographs.

The more scars a whale has, the easier it is to identify, up to a point, because the configuration provided by the arrangement of scars becomes increasingly complex and distinctive. With too many scars, however, the pattern starts to look uniform and indistinct. The locations of the scars on the whale's body can often be determined very precisely by making reference to the pale pigmentation pattern on the sides (see below and Fig. 6D).

We do not know the cause of the scars, but their uniform size and shape suggests a single biological origin. We have twice seen a parasitic copepod, *Pennella* sp., hanging from one of these scars (Fig. 6D), but the *Pennella* does not appear to be the cause, despite Ivashin and Golubovsky's (1978) observations on sei whales (*B. borealis*). In 16 instances when we obtained a good photograph of the location where a *Pennella* had been attached the previous year with no oval scar, there was no oval scar after the *Pennella* had fallen off. Conversely, in 12 instances where we obtained a good photograph of the location of a new white scar in the year before it appeared, there was no *Pennella* attached in that location. In addition, we have observed considerably fewer *Pennella* than fresh white scars. Therefore, the co-occurrence in Fig. 6D of two *Pennella* with white scars is atypical, and it is likely that the *Pennella* attached at the site of existing wounds.

Similar scars on other species of cetaceans have been attributed to lampreys (Pike, 1951; Nemoto, 1955) and to sharks (Jones, 1971; Shevchenko, 1971). There has been some confusion in the literature between the two sources; for example, Jones (1971) states that only some of Pike's (1951) scars were caused by lampreys, while others were caused by sharks. Some of the features that distinguish the two types of scars can only be observed in fresh wounds and/or at close proximity. The scars that we observed on these minke whales always appeared partially healed at the freshest (i.e., they must have been acquired in late fall, winter or spring) and our photographs did not yield sufficient resolution to see fine details. If it is true, as Shevchenko (1971) asserts, that lampreys can cause only circular wounds and scars, not oval ones, then lampreys are not the cause of the scars that we have observed. Crater wounds from sharks appear to be up to 2cm deep when fresh, whereas the scars we have observed are considerably more shallow, but this could be the result of the partial healing that has occurred by the time we see them.

Longitudinal sections through white scars presumably caused by shark bites on whales in the Southern Hemisphere imply that their contour is even with the surrounding skin (Shevchenko, 1971), while the scars in our minke whales are clearly depressions in the skin. We remain uncertain as to the origin or origins of the small oval scars we have observed, except to eliminate *Pennella* as a possibility.

Lateral body pigmentation

The third main feature used to identify these whales is the pattern of pale pigmentation on the sides. On the part of each side that is usually visible on a normal surfacing, this pigmentation appears divided into three distinct swaths, two wide ones and one narrow one (Fig. 6A). These swaths are homologous to the flank patch, thorax patch and crescent-shaped grey streak described and illustrated by Best (1985) for southern minke whales. We call the anterior-most swath (Best's grey streak) the shoulder streak, in order to indicate its location on the body.

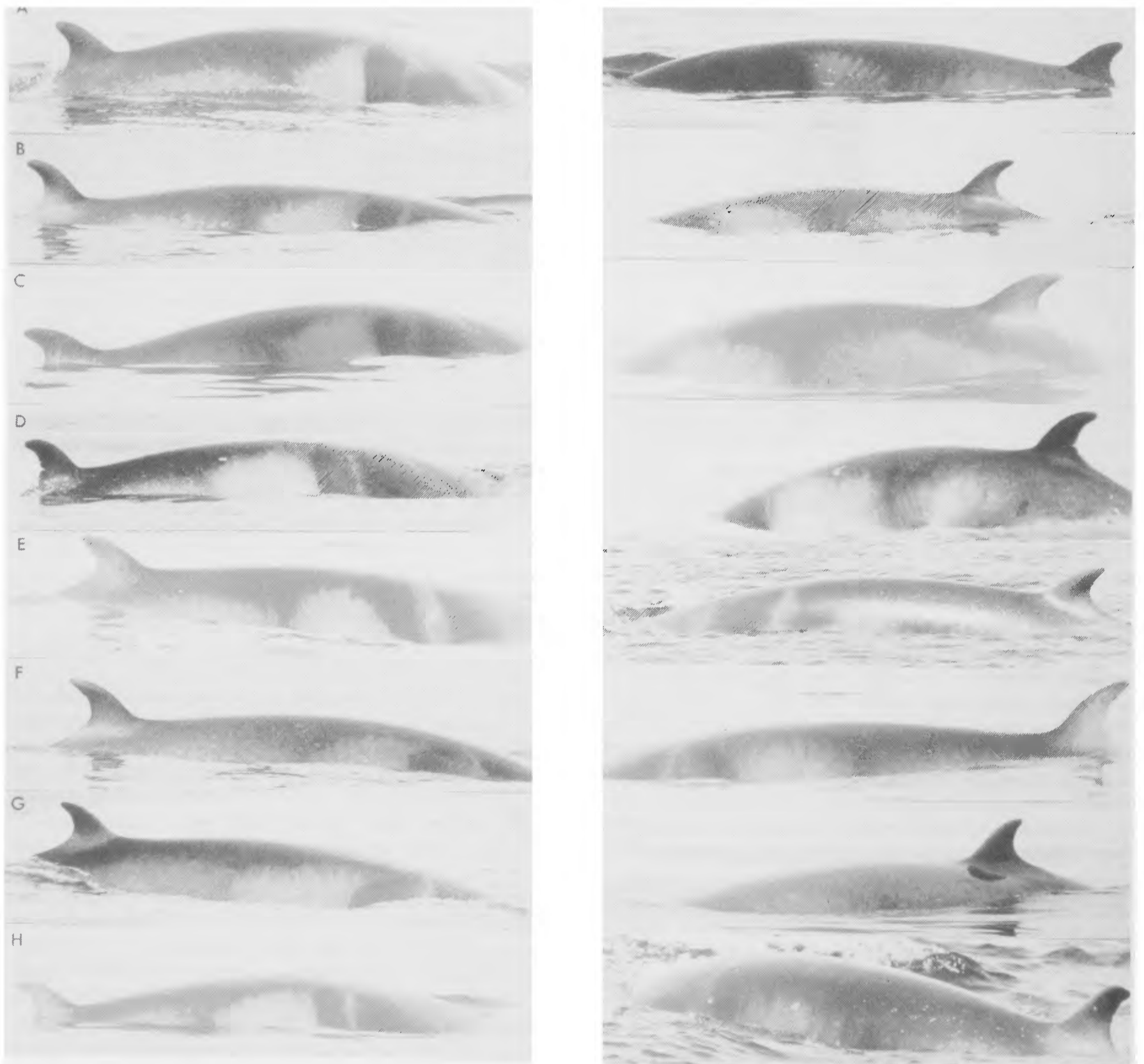

Fig. 7. Several examples of lateral body pigmentation. A. Whale S18. B. Whale S1. C. Whale S8. D. Whale S17. E. Whale S24. F. Whale S5. G. Whale M1. H. Whale S6.

The flank patch extends along the tail stock posterior to the dorsal fin (Figs 6B, 6C), and the flank and thorax patch join ventrally in the mid-lateral region (Fig. 6B). The thorax patch is always the brightest in our whales, whereas in the southern minke whales described by Best (1985) and Joyce and Dorsey (1990), the flank patch is brightest.

The shoulder streak extends the farthest dorsally of the three swaths, and tapers dorsally, reaching the mid-dorsum, at least in some whales. The shoulder streak in Antarctic minke whales forms a V on each side and a W when both V's are observed from above (Bushuev and Ivashin, 1986) and thus is similar in shape to the chevron on North Atlantic fin whales, *B. physalus* (Agler, Beard, Bowman, Corbett, Frohock, Hawvermale, Katona, Sadove and Seipt, 1990). We cannot say whether or not the shoulder streak in our minke whales takes this overall shape because we almost never photographed the dorsal and ventral extremes of the streak.

The configuration of the dorsal edge of the flank patch and the dorsal and anterior edge of the thorax patch varies between individuals (Fig. 7) and is stable over time. The flank patch is only rarely distinct enough to be useful by itself for individual recognition (Fig. 6C). The shoulder streak varies between individuals in width and shape and distance from the thorax patch (Fig. 7). It may have a dark line running through it or other variations in brightness, and like the two lateral patches, it is stable over time.

Lateral body pigmentation provides information useful for individual recognition not just by the idiosyncrasies of its configuration but also by providing references for specifying the location of oval scars. Fig. 6D shows how the pigmentation increases the information provided by the small scars: if either of the two bright scars in this photograph were located only as much as its own diameter toward or away from the edge of the pale pigmentation, that difference would be easily detectable, whereas it would be undetectable without the pigmentation boundary as a reference. Therefore the amount of information in a photograph like Fig. 6D is extremely high. In practice, the details of lateral pigmentation patterns are often not visible in photographs due to glare, back lighting, distance or fog. But even in medium to poor quality photographs, the pigmentation often helps to locate small scars. One whale observed repeatedly (S13) is exceptional in having lateral pigmentation so indistinct as to be almost useless for recognition, even in the best photographs.

Anterior to the shoulder streak there is usually an indistinct pale wash which extends forward to the blowhole region, but this wash is almost featureless and therefore not useful for individual recognition. We observed a pale thin streak on the dorsum trailing from each blowhole on two whales, fainter and narrower than the blowhole streaks described from southern minke whales (Best, 1985; Bushuev and Ivashin, 1986). We rarely obtained photographs from a suitable angle to see blowhole streaks, however.

Other distinctive features

A few minke whales have other features that help make them recognizable. Scars other than the small oval scars sometimes occur (Figs 3A, 3B); their persistence over time is probably variable, depending on the severity and perhaps the location of the wound. We have also observed small welts (Figs 3C, 4G), small depressions (Fig. 3D) and small bumps (Fig. 3E). The bump in Fig. 3E has persisted for at least three years. Three whales have been seen with

a long thin scratch (Fig. 3D) and in at least one of them the scratch has persisted for three years. Finally, these minke whales sometimes carry the ectoparasitic copepod *Pennella* (the dark lines in Fig. 6D). This parasite is highly visible and does not move once attached, but appears not to persist for more than one season, so it is useful only for resightings in the same year.

Resightings of individuals: small-scale site fidelity

We have identified 30 minke whales from the San Juan Islands, 17 from the Monterey Bay area and 8 from the Johnstone Strait area. No individual has been seen in more than one study site. Tables 4, 5 and 6 present, for the three study sites respectively, the number of sightings for each individual in each year. The total number of sightings per individual ranges from 1 sighting in 1 year to 37 sightings over 9 years. Within years, the span of sightings for many individuals is on the scale of months: in the San Juan Islands in 1982, the year with the longest field season, 15 whales were seen on more than one day, and the mean span between first and last sightings for these whales was 65 days (range = 6 – 107 days). The distribution of individuals by number of years seen shows a pattern that is similar at each

Table 4

Yearly sightings totals for each individual minke whale seen in the San Juan Islands.

ID No.	'84	'85	'86	'87	Total sightings	Total years seen
M1	3	2			5	2
M2	2				2	1
M3		6	6	1	13	3
M4		3	1	1	5	3
M5		5	1	2	8	3
M6		4			4	1
M7		4			4	1
M8		2			2	1
M9		1	5	3	9	3
M10		1			1	1
M11			1		1	1
M12			1	2	3	2
M13			1*		1	1
M14			1		1	1
M15				1	1	1
M16				1	1	1
M17				2	2	1

* Photographed north of study site near Santa Cruz.

Table 5

Yearly sightings totals for each individual minke whale seen in the Monterey Bay area.

ID No.	'81	'82	'83	'84	'85	'86	'87	Total sightings	Total years
J1	1	2	2	1		1		7	5
J2	1			1	1		1	4	4
J3	1		3	2		1		7	4
J4				1			1	2	2
J5				1				1	1
J6					1			1	1
J7				1				1	1
J8				2	1			3	2

Table 6
Yearly sightings totals for each individual minke whale seen in the Johnstone Strait area.

Month	Range	No. days with searching	% days with whales seen
April	A	2	0
	B	4	0
	C	3	33
May	A	5	0
	B	6	0
	C	7	28
June	A	5	0
	B	13	31
	C	8	50
July	A	4	100
	B	12	58
	C	4	75
August	A	5	100
	B	10	60
	C	7	71
September	A	7	100
	B	4	25
	C	5	60
October	A	3	100
	B	4	25
	C	3	33

site (Fig. 8). Many individuals in each study site were seen repeatedly over the years; 31 whales (56.4%) were seen in at least two years and 12 whales (21.8%) were seen in at least five years. Thus in each area there appears to be a small population, most of which is persistent over time within and between years, probably returning each summer from wintering grounds in an unknown location.

The distribution of individuals was strongly segregated within the San Juan Islands and the Monterey Bay area. Most individuals were seen exclusively or almost exclusively in only one of two subregions in Monterey Bay or in one of three subregions in the San Juan Islands. These subregions, which we call ranges, were obvious when we looked at where individual whales were seen. In the Monterey Bay area, range A is north of the deep water canyon that runs into Carmel Bay and range B is south of that canyon (Fig. 9). These two ranges include all locations where minke whales were seen and there were no apparent areas of concentration in either range. In the San Juan Islands, range A is northwest of Orcas Island, range B is east of San Juan Island and range C is south and west of San Juan Island (Fig. 2). These three ranges include almost all locations where minke whales were seen. A few sightings

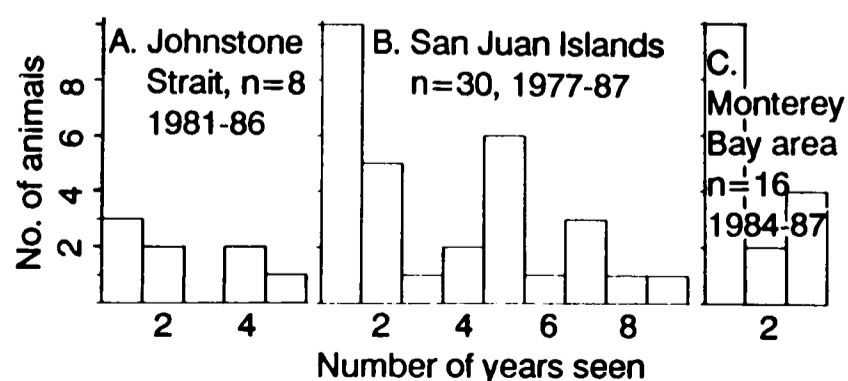

Fig. 8. Frequency distribution of number of years individual animals were seen. Years seen are not necessarily consecutive. A. Johnstone Strait area. B. San Juan Islands. C. Monterey Bay area.

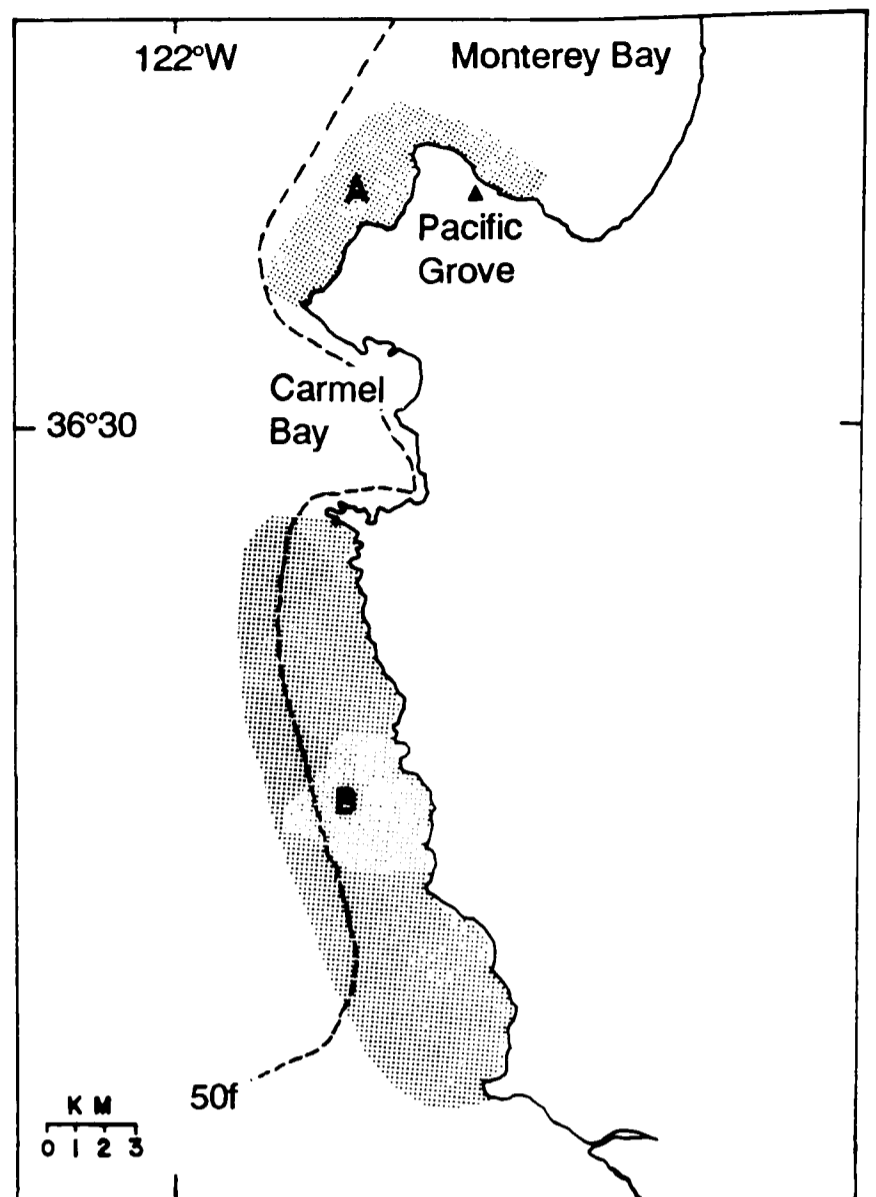

Fig. 9. The Monterey Bay study site, showing locations of the two separate ranges (stippling).

were made outside of these ranges, mostly northwest of San Juan Island, but they were too few and too distant from the majority of sightings for meaningful interpretation. Within each of the three separate ranges in the San Juan Islands, there were one or two smaller areas of concentration that we called feeding areas, where most sightings, most search effort and most visible feeding occurred.

We calculated, for each individual, the percentage of sightings that were inside its primary range and the range where it was seen most often (Fig. 10). In Monterey Bay, all whales were inside their primary range on at least 88% of the sightings. In the San Juan Islands, 14 out of 18 whales were inside their primary range on at least 94% of sightings. Two whales, however, were sighted in their primary range less than 60% of the time. One of these, whale S9, was sighted only five times over four years, with sightings evenly divided between ranges B and C, so its primary range is uncertain. The other, whale S5, was seen frequently (27 times over 8 years) and consistently moved around the study site more than any other whale; it was seen in more than one range in most years.

In the Monterey Bay area, we have seen whales turn around as they approach the border of their primary range and then swim back toward the middle of the range. This occurred five times at the northern border and twice at the southern border of range A, and six times at the northern border of range B (Fig. 9). We are not sure how far south range B extends.

In the San Juan Islands, we never observed a clear example of a whale turning around at a border, but twice we followed a whale across the border between range B

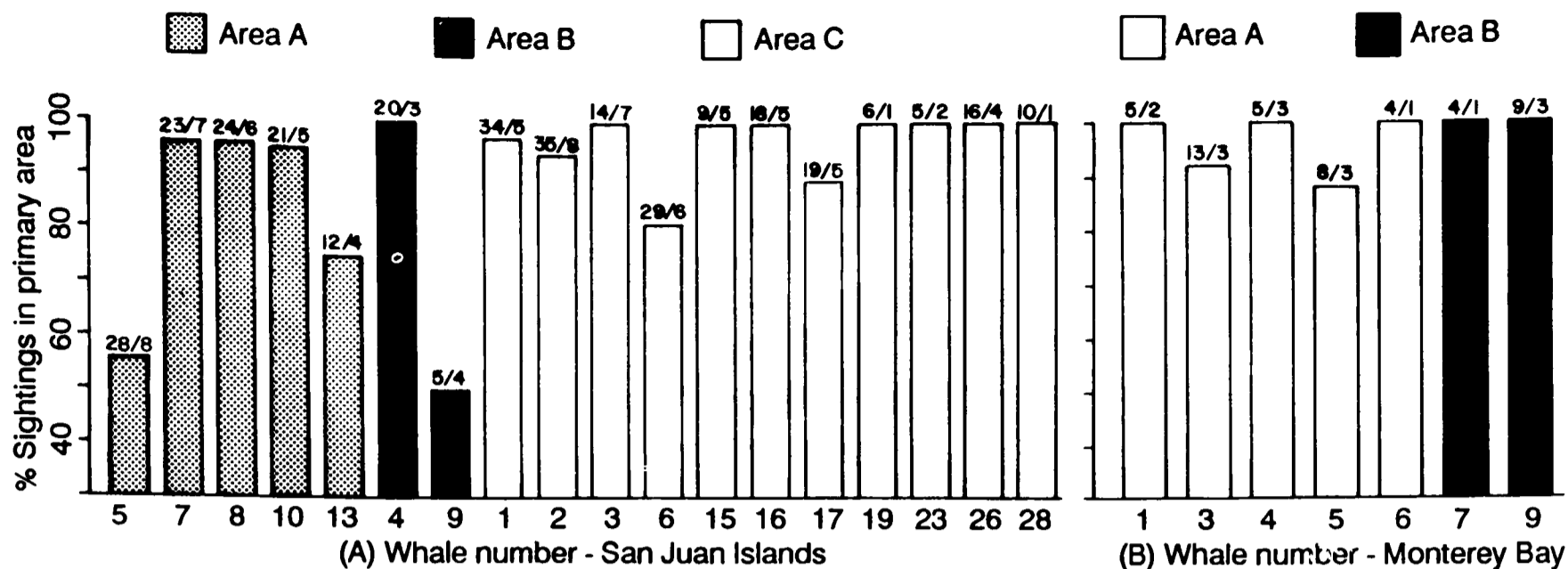

Fig. 10. Percent of sightings of each individual that were in that animal's primary range. A. San Juan Islands. B. Monterey Bay area. Numbers at top of columns are number of sightings/number of years seen (not necessarily consecutive years). Whales are included only if they had four or more sightings in Monterey Bay or five or more sightings in the San Juan Islands. Incidental sightings before and after 1980-84 in the San Juan Islands are included unless location is not known.

and range C. We observed whales moving between the two feeding areas in range C and all whales seen on the southern feeding area in range C were also seen on the northern feeding area in that range. The light stippling for each range in Fig. 2 may not include the full extent of the movements of the whales resident to that range. Several times we followed whales as they traveled north or northwest from the feeding area in range A or south or southeast from the northern feeding area in range C, but we usually had to leave these whales while they were still heading away from their feeding area. It is possible that there are additional feeding areas in places that we never or rarely searched.

In the San Juan Islands where we have the longest span of observations, we looked at each range from 1980-84 to see how consistently individuals occupied them. Range A had the most stable constituency, with five whales seen repeatedly over the years, accounting for all but 1 of 88 sightings (Table 7). From 1980-83, all sightings were within the feeding area or started inside the feeding area. Whales could be found reliably from July onward (Table 3) and

feeding was commonly observed. In 1984, however, there was a dramatic decrease in the number of sightings. Only two individuals were identified inside the feeding area and almost no feeding was observed (Table 7). Sighting effort in the feeding area in range A was almost as great in 1984 as in 1983, for example, but we were following whales during only 16% of the time spent in the feeding area in 1984, compared to 76% of the time in 1983. In 1980-83, seabirds, in mixed flocks of gulls and alcids, regularly fed on the same baitfish as the whales, but the birds were also mostly absent from the feeding area in 1984. We observed 2.3 actively feeding flocks of seabirds per hour of observation in 1983, but only 0.2 flocks per hour in 1984. We conclude that in 1984, the baitfish, probably herring, were dramatically reduced and that the resident minke whales of range A were forced to look elsewhere for food. We found three of the usual residents of range A (S8, S10 and S13) in range B in 1984, the first time during the study period that we had seen any of those whales in range B. The other sightings of range A residents in 1984 were mostly in range A but outside the feeding area, in places that we had rarely or never visited in previous years. This striking change in the use of range A in 1984 was the most dramatic change over time that we observed in the San Juan Islands.

Range B had the least stable constituency over the years of the three ranges and had consistently the lowest number of sightings per year. In 1980-82 we repeatedly and consistently found one whale, S4, in range B and occasionally saw other whales there, especially in 1982. Since 1982 we have not seen whale S4 and we have made only a few sightings in that range (Table 8). All of those sightings were in 1984 and most were of the three range A residents mentioned above. Our impression is that whale S4 died or moved away permanently after 1982 and no other whale took up residence in that range in 1983 or 1984.

Range C had the greatest number of sightings and the greatest number of identified individuals in every year. Five whales were seen there in every year, while seven whales were seen there in only one year (Table 9). Most of the whales seen in range C in only one year were never seen in any other part of the study site and they could be either transients in Washington waters or residents near range C in areas that we did not search. Range C had a roughly similar occupancy pattern in all five years in terms of number of individuals and number of sightings.

Table 7

Individual sightings and feeding events observed in range A in the San Juan Islands by year, 1980-84. See Hoelzel *et al.* (1989) for definitions of definite and probable feeding events.

ID no.	1980	1981	1982	1983	1984
S5	6	4	1	4	
S7	4	4	8	4	1*
S8	4	3	12	1	2*
S10	3	1	8	7	1
S13	1		3	4	1
S21			1		
Total id'd sightings	18	12	33	20	5
No. individuals identified	5	4	6	5	4
No. definite feeding events	5	8	39	25	0
No. probable feeding events	11	36	64	6	2

* Seen only outside of feeding area.

Table 8

Individual sightings in range B in the San Juan Islands by year, 1980–84. The letter in parentheses after the identification # is the primary range for each whale, if not range B.

ID no.	1980	1981	1982	1983	1984
S4	5	5	10		
S9(B?)	1	2			
S1(C)			1		
S5(A)			1		
S6(C)			5		
S20(C)			1		
S29(?)					1
S8(A)					1
S10(A)					1
S13(A)					2
Total id'd sightings	6	7	18	0	5
No. individuals identified	2	2	5	0	4

* One sighting of this whale was in both ranges B and C.

Table 9

Individual sightings in range C in the San Juan Islands by year, 1980–84. The letter in parentheses after the identification # is the primary range for each year.

ID no.	1980	1981	1982	1983	1984
S1	12	6	3	3	9
S2	6	6	4	3	12
S3	2	1	1		
S6	7	8	4*	3	2
S11	3	1			
S12	3				
S14	1				
S15	1	2	2	1	3
S16	6	5	3	1	3
S17		6	6	3	
S18			2	1	
S19			6		
S20				1	1
S22		1			
S23				4	1
S24				2	
S25				1	1
S26				1	11
S28					10
S5(A)		2	1	3	1
S9(B?)	1*		1		1
S13(A)			1		
Total id'd sightings	41	38	34	28	59
No. individuals identified	10	10	13	14	11

* One sighting of this whale was in both ranges B and C.

Factors affecting photo-identification success

The process of successfully identifying an individual whale from a photograph can be divided into three stages: (1) finding the whale; (2) photographing the whale; and (3) identifying the whale from the photographs. We have some information on three factors that affect one or more of these stages – sea conditions, movement pattern (milling vs travel) and degree of clumping of surfacings.

The calm conditions that prevail in the waters of the San Juan Islands and the Johnstone Strait region in summer clearly facilitate finding the whales, for two main reasons.

First, with smaller waves and swells, it is easier to spot the body of a whale when it surfaces (the blow is never visible enough in these whales to provide a sighting cue). Second, the reduced ambient noise from calm water makes it possible to hear blows, sometimes at considerable distances. Calm water also facilitates the taking of photographs by making it easier to position the whale in the viewfinder of the camera.

We have quantified the ease of getting into position for photographs suitable for individual recognition in the Monterey Bay area and in range C of the San Juan Islands. To our surprise, we found that whales were easier to photograph in the rougher, outer coast waters around Monterey Bay (Stern, Dorsey and Case, 1990). This appears to be due to differences in both of the two other factors that affect ease of obtaining a suitable photograph. First, the Monterey Bay minke whales were all traveling in fairly straight paths so that the direction of movement of the whale underwater during long dives was predictable. The San Juan Islands whales, in contrast, were all milling about within the northern feeding area of range C. Second, the Monterey Bay whales made surfacings that were strongly clumped in time, with long dives separating a quick succession of surfacings, while the surfacings of whales in range C of the San Juan Islands were more evenly distributed over time (see below for further description). We were not able to separate out the effects of these two factors, but their combined effect more than compensated for the difficulty introduced by the rougher sea conditions near Monterey Bay. Sometimes minke whales in the San Juan Islands travel in predictable paths and sometimes their surfacings are strongly clumped, but we have no data on their photographability at these times to compare with Monterey Bay whales.

The rate at which whales were successfully identified from the photographs taken was comparable in the Monterey Bay region and in the San Juan Islands. In Monterey Bay, the mean annual identification rate was 80%, with a range from 66% to 92% (the latter rate was obtained in 1985, the year with the calmest conditions). In the San Juan Islands, the mean annual identification rate was 77%, with a range from 72% to 86%. This similarity in identification rates was obtained in spite of using only a 200mm lens in the Monterey Bay region, compared to a 300mm lens most of the time in the San Juan Islands.

We looked at the identification rate for each range in the San Juan Islands in 1982, the year with the best coverage of all three ranges, considering only photographs taken with a lens of 300 or 400mm. The rate for each range was as follows: 96% (n=48) for range A, 97% (n=36) for range B, and 74% (n=70) for range C. In all three ranges most whales were milling within feeding areas. The high identification rates occurred in the two ranges where the predominant type of feeding is lunge feeding, while the lower identification rate occurred in the range where the predominant type of feeding is in association with seabirds. The two types of foraging are associated with distinctly different surfacing patterns, with surfacings more strongly clumped for lunge feeders. Lunge feeding whales tend to make long dives of about 230s followed by a series of much shorter dives, about 22s in duration (Hoelzel *et al.*, 1989). Thus the surfacings are strongly clumped with up to seven in rapid succession. If it takes about three surfacings on average to first get into position for a suitable photograph (Stern *et al.*, 1990), a whale that surfaces six times in a row may offer three additional opportunities for photographs.

Whales feeding in association with seabirds, on the other hand, make shorter long dives (about 90s) and longer short dives (about 65s) (Hoelzel *et al.*, 1989). Their surfacing series are less well defined, containing fewer surfacings and more time between them, which makes the whales harder to photograph.

Traveling whales in all three ranges of the San Juan Islands and in the Monterey Bay area usually surface with a pattern similar to that in lunge feeding whales, that is, with long dives followed by a quick succession of four or more surfacings. Thus traveling whales are easy to photograph well and identify, both because of the relatively predictable location of surfacings after long dives and because of the rapid succession of surfacings in each surfacing series.

We have not tried to assess the relative importance of these three factors that affect the success of photo-identification in minke whales, but the extremes are obvious. The easiest minke whales to identify are traveling with strongly clumped surfacings in calm water; the most difficult to identify are milling with weakly clumped surfacings in rough water.

DISCUSSION

The photo-identification of individuals is clearly a feasible and promising technique with the North Pacific minke whales we have studied, as it is with other species of baleen whales (e.g. Katona, Baxter, Brazier, Kraus, Perkins and Whitehead, 1979; Payne, Brazier, Dorsey, Perkins, Rowntree and Titus, 1983; Sears, Williamson, Wenzel, Bérubé, Gendron and Jones, 1990; Agler *et al.*, 1990). We have used the technique only for behavioral studies, but estimates of population parameters, including population size, would be possible with properly designed studies (Joyce and Dorsey, 1990). Estimates of reproductive parameters, like calving interval and age at first calving, which require photographs of mother-calf pairs, may be more difficult to obtain in minke whales than in some other species of baleen whales. The lactation period in minke whales appears to be so short that most calves are weaned before reaching summer feeding grounds (for a review, see IWC, 1986, p.13). The absence of mother-calf sightings in our three study areas is not unusual for higher latitudes. With few exceptions, minke whale distribution in winter at lower latitudes is poorly known, and no nearshore calving grounds have been found. Thus, it may be quite difficult to obtain photographs of minke whale mother-calf pairs.

Minke whales from the western North Atlantic have been recognized individually from photographs of variable dorsal fin profiles (Sears, Wenzel and Williamson, 1987; Peggy Edds, pers. comm.), individually distinctive lateral pigmentation similar to that in our area (Fig. 6B; Sears *et al.*, 1987) and miscellaneous scars (Sears *et al.*, 1987). These whales do not appear to have the small oval scars that are so helpful for recognizing our minke whales.

Joyce and Dorsey (1990) have shown that photo-identification of minke whales is a usable technique in the Antarctic, based upon the same external features used in this study. Antarctic minke whales also have two features on the dorsal surface that might be useful for individual recognition from aerial photographs taken from directly above: gray streaks from the blowhole and a W-shaped pattern formed by the dorsal extensions of the shoulder streaks (Bushuev and Ivashin, 1986). Both of these features are reported to be quite variable between individuals, and the photograph in Best (1985) of the blowhole streaks shows them to be very contrastively colored. In

South Africa two color phases have variable pale pigmentation on the sides of the body (Best, 1985) that might facilitate individual recognition from broadside photographs.

The temporal and spatial pattern of individual resightings in our three study sites has several implications. It suggests small populations of minke whales in each site that are resident during summer and early fall and present year after year, except for a few strays. If the whales do indeed migrate away for the winter, as indications suggest, then they return each year, not just to a particular study site, but to a particular subregion of the study site, at least in two of the areas. Whether or not these whales mix in the winter is unknown, as is the location of their calving grounds. The near disappearance of whales from the northernmost feeding area in the San Juan Islands in 1984, apparently due to a local decrease in baitfish, suggests that the distribution of these whales may be largely determined by the distribution of prey. This would not be surprising since feeding is the primary activity of most baleen whales in summer.

In the western North Atlantic, Sears *et al.* (1987) have reported the return of 12 photo-identified minke whales to the same part of the Gulf of St. Lawrence over six years. In the Southern Hemisphere, numbered steel tags (.410 Discovery marks) fired into minke whales have provided some information on movements of individual animals when they are recovered on whaling ships (Buckland and Duff, 1989). The 71 marks recovered through the 1982/83 Antarctic whaling season show some very long range movements between years, but also a few year-to-year recoveries on a scale as small as our study sites (Wada, 1984).

The age and sex segregation in minke whales that has been reported from catch data (see IWC, 1986) is over distances that are one or two orders of magnitude greater than the segregation we observed within two of our study sites. Therefore we do not believe that the spatial segregation that we report here is caused by the same phenomenon.

In addition to small-scale spatial segregation, persisting over several years, we have also observed in the San Juan Islands individual specializations on one of two different foraging strategies (Hoelzel, *et al.* 1989). It is possible that both types of specialization (on area and on feeding strategy) are behaviors that maximize feeding efficiency. In the San Juan Islands, there are strong tidal exchanges, up to 5m in height, which create currents, rips and eddies that vary characteristically from locale to locale. The minke whale feeding areas also differ in topography, some being shallow banks in open waters, others being deeper basins enclosed by islands, with small seamounts. Therefore, the tidally induced water movements must be idiosyncratic in each range, and these movements may have a large effect on the distribution of the whales' prey. Minke whales may be able to feed most efficiently when they get to know the idiosyncrasies of a small area well, and also when they specialise on a certain foraging strategy.

ACKNOWLEDGEMENTS

This research was funded by grants from the following sources: the American Cetacean Society-Los Angeles Chapter, the American Philosophical Society, the Lerner Fund for Marine Research, the National Geographic Society, the New York Zoological Society, Population

Dynamics, and the World Wildlife Fund-US. Many people helped with the field work; we specifically thank the following for photographs of minke whales: Tom Arnbom, Robin Baird, Ken Balcomb, Steve Booth, Linda Campbell, Eric Carlson, Judy Carter, Victoria Case, the Center for Coastal Studies, Megan Dethier, John Domont, Graeme Ellis, Rob Ellis, Richard Fox, Fred Felleman, Ray Fowler, Nancy Haenel, Suzanne Healy, Jim Heimlich-Boran, Susan Kruse, Mark Lewis, Thomas Lyrholm, Elizabeth Miller, Hiroya Minakuchi, Alexandra Morton, Steve Mulane, Laura Norris, Tamara Ossipof, Jan Ostman, Sarah Prentiss, James Scarff, Barbara Todd, Paula Trost, and Willy Wason. We also wish to express our gratitude to the following for logistical support: Jay Anderson, Mark Anderson, Alan Baldrige, Jim Darling, Jim Fox, Steve Insley, Roger Payne, Earl Simon, Bruce Stedman, the University of Washington Friday Harbor Laboratories, Stanford University's Hopkins Marine Station, the Whale Museum, and the Vancouver Public Aquarium. We are grateful to Victoria Rowntree, Jon Seger and two anonymous reviewers for their comments on the manuscript.

REFERENCES

- Agler, B.A., Beard, J.A., Bowman, R.S., Corbett, H.D., Frohock, S.E., Hawvermale, M.P., Katona, S.K., Sadove, S.S. and Seipt, I.E. 1990. Finback whale, *Balaenoptera physalus*, photographic identification: methodology and preliminary results from the western North Atlantic. Paper SC/A88/ID20 (published in this volume).
- Best, P.B. 1982. Seasonal abundance, feeding, reproduction, age and growth in minke whales off Durban (with incidental observations from the Antarctic). *Rep. int. Whal. Commn* 32:759-86.
- Best, P.B. 1985. External characters of southern minke whales and the existence of a diminutive form. *Sci. Rep. Whales Res. Inst., Tokyo* 36:1-33.
- Best, P.B. and Butterworth, D.S. 1980. Report of the Southern Hemisphere minke whale assessment cruise, 1978/79. *Rep. int. Whal. Commn* 30:257-83.
- Bigg, M.A. 1982. An assessment of killer whale (*Orcinus orca*) stocks off Vancouver Island, British Columbia. *Rep. int. Whal. Commn* 32:655-66.
- Bigg, M.A., Olesiuk, P.F., Ellis, G.M., Ford, J.K.B. and Balcomb, K.C. 1990. Social organisation and genealogy of resident killer whales (*Orcinus orca*) in coastal waters off British Columbia and Washington State. Paper SC/A88/ID39 (published in this volume).
- Buckland, S.T. and Duff, E.I. 1989. Analysis of Southern Hemisphere minke whale mark-recovery data. *Rep. int. Whal. Commn* (special issue 11):121-43.
- Butterworth, D.S. and Best, P.B. 1982. Report of the Southern Hemisphere minke whale assessment cruise, 1980/81. *Rep. int. Whal. Commn* 32:835-74.
- Bushuev, S.G. and Ivashin, M.V. 1986. Variation of colouration of Antarctic minke whales. *Rep. int. Whal. Commn* 36:193-200.
- Dorsey, E.M. 1983. Exclusive adjoining ranges in individually identified minke whales (*Balaenoptera acutorostrata*) in Washington state. *Can. J. Zool.* 61(1):174-81.
- Everitt, R.D., Fiscus, C.H. and DeLong, R.L. 1979. Marine mammals of northern Puget Sound and the Strait of Juan de Fuca: a report on investigations November 1, 1977 to October 31, 1978. US Dept. Commerce, NOAA Tech. Memo. ERL MESA-41.
- Hoelzel, A.R., Dorsey, E.M. and Stern, S.J. 1989. The foraging specializations of individual minke whales. *Anim. Behav.* 38:786-94.
- International Whaling Commission. 1986. Report of the workshop. *Rep. int. Whal. Commn* (special issue 8):1-56.
- Ivashin, M.V. and Golubovsky, Y.P. 1978. On the cause of appearance of white scars on the body of whales. *Rep. int. Whal. Commn* 28:199.
- Jacobsen, J.K. 1986. The behavior of *Orcinus orca* in the Johnstone Strait, British Columbia. pp.135-186. In: Kirkevold, B.C. and Lockard, J.S. (eds), Behavioral Biology of Killer Whales. *Zoo Biology Monographs*. Vol. 1. Alan R. Liss Inc. New York.
- Jones, E.C. 1971. *Isistius brasiliensis*, a squaloid shark, the probable cause of crater wounds on fishes and cetaceans. *Fish. Bull., US* 69(4):791-8.
- Jonsgård, Å. 1951. Studies on the little piked whale or minke whale (*Balaenoptera acuto-rostrata*). *Norsk Hvalfangsttid.* 40(5):209-32.
- Katona, S., Baxter, B., Brazier, O., Kraus, S., Perkins, J. and Whitehead, H. 1979. Identification of humpback whales by fluke photographs. pp. 33-44. In: H.E. Winn and B.L. Olla (Eds.) *Behavior of Marine Animals, Vol. 3: Cetaceans*. Plenum Press, N.Y.
- Nemoto, T. 1955. White scars on whales - Lamprey marks. *Sci. Rep. Whales Res. Inst., Tokyo* 10:69-77.
- Omura, H. and Sakiura, H. 1956. Studies on the little piked whale from the coast of Japan. *Sci. Rep. Whales Res. Inst., Tokyo* 11:1-37.
- Payne, R., Brazier, O., Dorsey, E.M., Perkins, J.S., Rowntree, V.J. and Titus, A. 1983. External features in southern right whales (*Eubalaena australis*) and their use in identifying individuals. pp. 371-445. In: R. Payne (ed.), *Communication and Behavior of Whales*. AAAS Selected Symposium 76. Westview Press. Boulder, Co. 643pp.
- Pike, G.C. 1951. Lamprey marks on whales. *J. Fish Res. Bd. Can.* 8(4):275-80.
- Sears, R., Wenzel, F.W. and Williamson, J.M. 1987. The Blue Whale: A Catalogue of Individuals from the Western North Atlantic (Gulf of St. Lawrence). Mingan Island Cetacean Study. Saint-Lambert (QC), Canada. Various paginated.
- Sears, R., Williamson, J.M., Wenzel, F.W., Bérubé, M., Gendron, D. and Jones, P. 1990. Photographic identification of the blue whale (*Balaenoptera musculus*) in the Gulf of St Lawrence, Canada. Paper SC/A88/ID23 (published in this volume).
- Shevchenko, V.I. 1971. A contribution to the question of the origin of 'white scars' on the body of whales. In: Chapskii, K.K. and Mil'chenko, E.S. (eds), Research on Marine Mammals. Atl. Nauchno-Issled. Inst. Rybn. Khoz. Okeanogr. 39:1-344. Translation from Russian published in 1974 in Ottawa by Canadian Index of Scientific Translations, Canada Inst. for Scientific and Technical Information, National Research Council Canada, Translation Series No. 3185, pp.105-117.
- Stern, J.S., Dorsey, E.M. and Case, V.L. 1990. Photographic catchability of individually identified minke whales (*Balaenoptera acutorostrata*) of the San Juan Islands, WA and Monterey Bay area, CA. Paper SC/A88/ID34 (published in this volume).
- Wada, S. 1984. Movements of marked minke whales in the Antarctic. *Rep. int. Whal. Commn* 34:349-55.
- Williamson, G.R. 1975. Minke whales off Brazil. *Sci. Rep. Whales Res. Inst., Tokyo* 27:37-59.

Abundance, Seasonal Distribution and Population Composition of Balaenopterid Whales in the Canal De Ballenas, Gulf of California, Mexico

Bernie R. Tershy¹, Dawn Breese² and Craig S. Strong³

ABSTRACT

The Canal de Ballenas, in the Gulf of California, Mexico, is sub-tropical but has high rates of year-round productivity. It is used by four balaenopterid species of whales. Between May 1983 and April 1986 2,758 hours were spent in a small boat censusing and photo-identifying balaenopterid whales in a 20 x 45 km section of the Canal. A total of 9 individual blue whales, 148 individual fin whales, 160 individual Bryde's whales and 6 individual minke whales were identified. At the same time 9 blue, 291 fin, 307 Bryde's and 17 minke whales were seen. The number of sightings per identified individual suggests that blue and fin whales are more transient to the study area than Bryde's and minke whales. This indicates that photo-identification data can improve the interpretation of sightings data.

The numbers of whales sighted per hour suggests that blue whales were most abundant in April and May while minke whales were equally abundant throughout the year. Fin and Bryde's whales were found in the study area in all months of the year but fin whales were more abundant in the winter and spring and their numbers were negatively correlated with water temperature. Bryde's whales were more abundant in the summer and fall and their numbers were positively correlated with water temperature. The percentage of identified individual adults that were females with calves was 10.6 for Bryde's and 2.7 for fin whales. Known female Bryde's whales showed the same within season distribution as Bryde's whales of undetermined sex but were more resident to the study area. When lactating they were thinner than pregnant or resting females, or whales of undetermined sex.

INTRODUCTION

The Gulf of California is a sub-tropical sea with areas of high year round productivity where concentrations of whales of the genus *Balaenoptera* are known to occur. Because it has never been an area of intensive commercial whaling, little is known about large whales there. From 1983-86, we used a combination of photo-identification, census and behavioral studies to examine the abundance, seasonal distribution and population composition of balaenopterid whales in one part of the central Gulf of California, the Canal de Ballenas.

Data from a number of cruises, combined with incidental observations, have provided a broad picture of distribution and abundance of balaenopterids in the Gulf. Blue whales have been reported in the Canal de Ballenas (Wells, Würsig and Norris, 1981), the northern Gulf (P. Turk pers. comm.), the eastern Gulf off Sonora (Vidal, Findley, Robles, Carvallo and Maldonado, 1986), the Loreto area (Vidal *et al.*, 1986; Sears, Bérubé and Gendron, 1987) and at the mouth of the Gulf (Leatherwood, Reeves, Perrin and Evans, 1982; Aguayo, Urbán, Sanchez and Rojas, 1986). They are most abundant in late winter and spring with the largest concentrations off the Loreto area (Leatherwood *et al.*, 1982; Sears *et al.*, 1987; Vidal *et al.*, 1986), although not in all years (D. McIntyre pers. comm.).

Because fin whales are seen in the Gulf of California throughout the year, and sightings near the mouth of the Gulf are rare, many authors have speculated that they are a resident, possibly isolated population (e.g. Wells *et al.*,

1981; Leatherwood *et al.*, 1982; Gambell, 1985). Fin whales are the most frequently observed mysticete with sightings in all parts of the Gulf (Van Gelder, 1960; Wells *et al.*, 1981; Leatherwood *et al.*, 1982; Aguayo, Findley, Rojas and Vidal, 1983; Rojas, 1984; Cummings, Thompson and Ha, 1985). They seem to be most abundant around the Midriff Islands (Aguayo *et al.*, 1983).

Bryde's whales have been sighted in the southern Gulf (Rice, 1977; Leatherwood *et al.*, 1982; Cummings *et al.*, 1985; Flores and Fleischer, 1987; 1988; Salinas and Bourillon, 1988), both sides of the central Gulf (Balcomb, Villa-R and Nichols, 1979; Rojas, 1984; own data) and the northern Gulf (Vidal, Aguayo, Findley, Robles, Bourillon, Vomend, Turk, Garate, Maronas and Rosas, 1985; G. Silber, pers. comm.). They have not been reported as often as fin whales but it is probable that they have at times been mistaken for fin whales, adding confusion to the data on distribution and abundance for both species (B. Würsig, pers. comm.; own data).

Minke whales have been reported in the central (Balcomb *et al.*, 1979) and northern Gulf (Wells *et al.*, 1981). Apart from the sei whale (*B. borealis*), which has only been sighted at the mouth of the Gulf (Aguayo *et al.*, 1986), the minke whale is the least often sighted balaenopterid in the Gulf.

STUDY AREA

We conducted research between 1983 and 1986 in a 20 x 45 km area in the Canal de Ballenas, between Isla Angel de la Guarda and the Baja California peninsula (Fig. 1). The oceanography of the study area is described by Roden (1964) and Alvarez-Borrego (1983). Three important features of the area are: (1) extreme spatial habitat variability including rocky points, islands, pelagic waters with depths exceeding 1,500 m and shallow sandy bays; (2) extreme temporal habitat variability with temperate water conditions and prevailing northwest winds in the winter and spring, and tropical water conditions with southeast

¹ Moss Landing Marine Laboratories, P.O. Box 450, Moss Landing, CA 95039-0450, USA; present address: Section of Neurobiology and Behavior, Seeley G. Mudd Hall, Cornell University, Ithaca, NY 14853, USA.

² Environmental Field Program, University of California, Santa Cruz, CA 95064, USA; present address: 177 Burns Road, Brooktondale, NY 14817, USA.

³ Moss Landing Marine Laboratories, PO Box 450, Moss Landing, CA 95039-0450, USA.

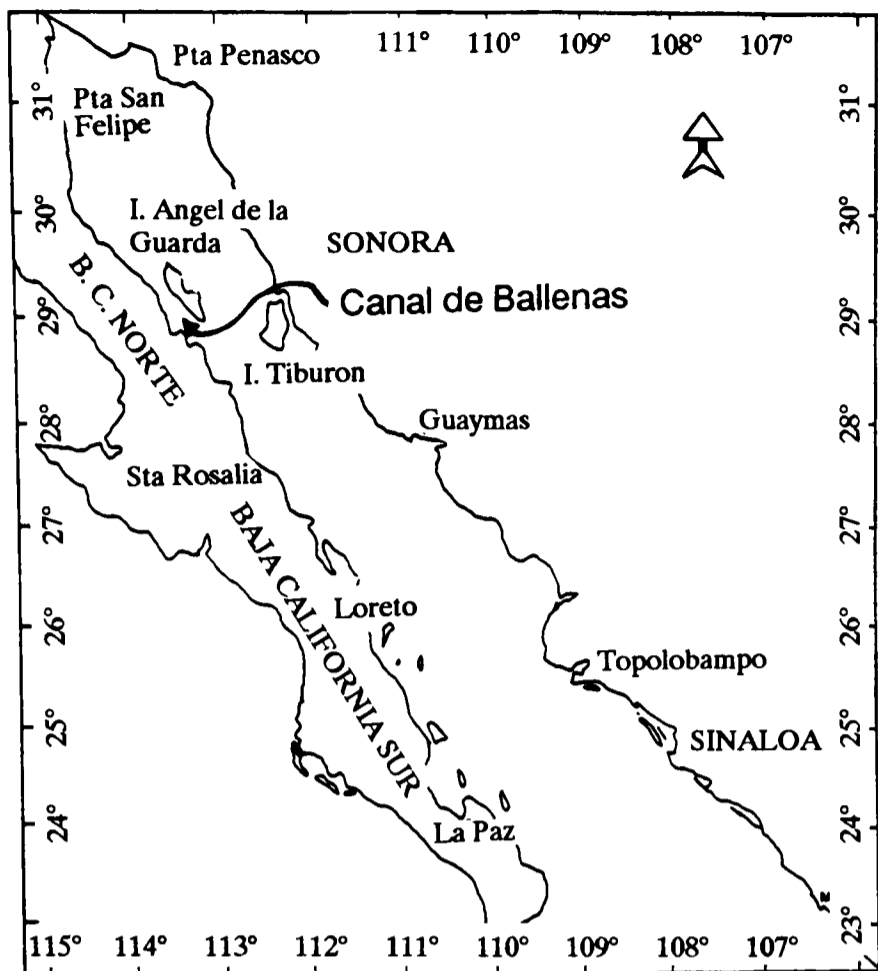

Fig. 1. The study area.

winds in the summer and fall (Fig. 2); and (3) strong tidal currents (up to 3m/sec, Alvarez, Badan-Dangon and Robles, 1984) which flow through the Canal, extensively mixing the water column. This keeps photic zone nutrient levels high enough to sustain year-round primary productivity comparable to major upwelling zones (Alvarez-Borrego, 1983). Sea surface temperatures in the Canal de Ballenas are persistently lower than in the rest of the Gulf of California (Alvarez-Borrego, 1983; Badan-Dangon, Koblinksi and Baumgartner, 1985). For example in July mean sea surface temperatures are 27–29.5°C throughout the Gulf (Robinson, 1973), but about 25.5°C in the Canal de Ballenas.

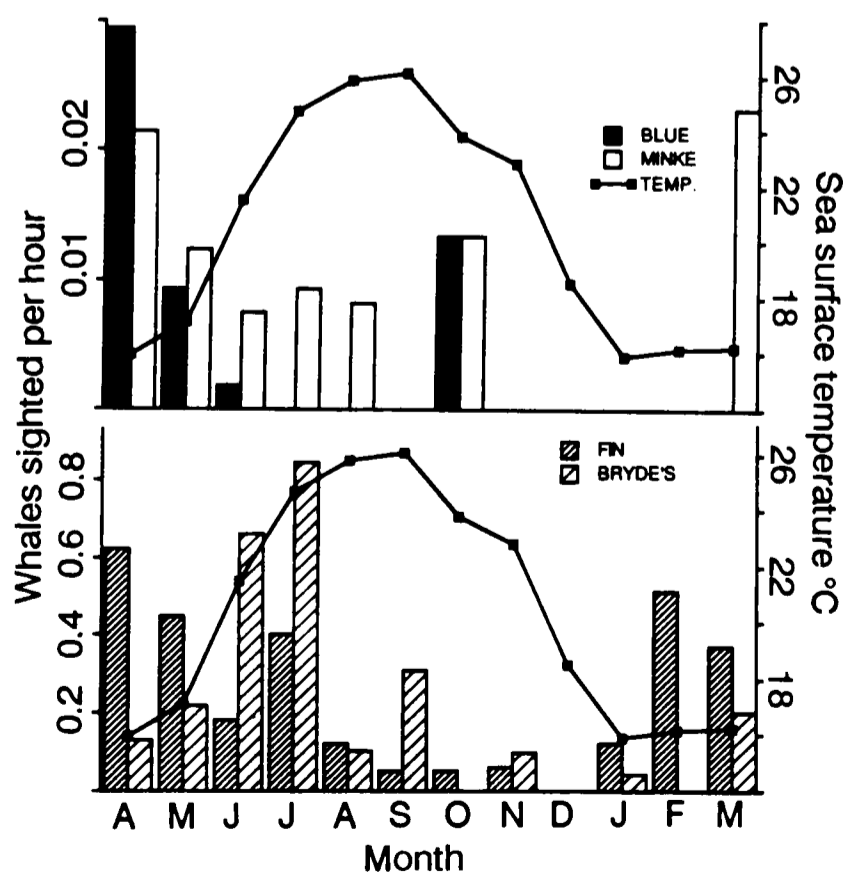

Fig. 2. Mean monthly sea surface temperature and the number of (A) blue and minke whales sighted per hour and (B) fin and Bryde's whales sighted per hour. Data for all years combined.

Table 1

Dates of field work and hours of boat time		
Year	Dates in Field	Boat Hours
1983	25 May - 29 August	588
1984	3 April - 28 August	788
1985	6 April - 9 November	1,131
1986	14 January - 28 March	251

METHODS

We worked from a 4.2 m inflatable boat whenever seas were Beaufort 2 or less (approximately 74% of the days from April through August, and 52% of the days from September through March). Table 1 and Fig. 3 summarise dates and hours worked. Our primary goal was to photo-identify as many individual whales as possible. While doing this we censused whales and other marine animals with a consistent but non-random search method in which we ran the boat in a straight line at planing speed for 5 or 10 minutes then shut off the engine for 15 minutes to listen for the blows or exhalations of whales (blows were often audible from a distance of over 5 km). All cetaceans were counted regardless of distance from the boat and no attempt was made to correct for interspecific differences in sightability. At each of these 15 minute stops we recorded our location by triangulation from known landmarks with a hand held sighting compass. We then made a 360° binocular scan, and recorded the number of whales and other marine animals sighted. Several times a day we measured sea surface temperature and secchi disc depth. We made no attempt to randomize the search effort on a daily basis and frequently concentrated our efforts in areas where we felt whales were most abundant. However, on a weekly basis we made an effort to cover most of the study area. Observer consistency within and between years was high because one of us (BRT) was present and consistently collected data for over 95% of the boat days (a detailed description of research methods can be found in Tershey, 1984).

When a whale was sighted we recorded the location, behavior (using the ethogram in Tershey, 1984) and group size or number of aggregated whales. Following Wilson (1975) we defined an aggregation as a number of individuals gathered in the same place but without obvious internal organization or cooperative behavior, and a group

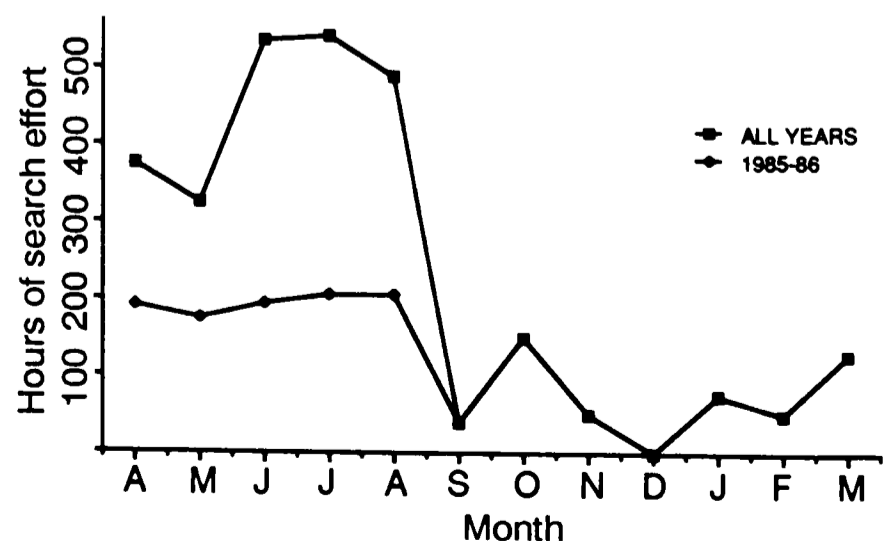

Fig. 3. The distribution of research effort from all years combined, open squares, and from 1985–86 when we were in the field during all four seasons of the year, closed triangles.

as a set of organisms that remain together for a period of time while interacting with one another to a distinctly greater degree than with other conspecifics. In practice this meant two or more animals swimming within 50m of each other engaged in the same behavior at the same time with coordinated swimming and respiratory behavior. We attempted to identify individuals by photographing the unique shape of the dorsal fin as well as scars and pigmentation patterns on the dorsal surface. We took photos when our boat was parallel to and within 60m of the whale using a 300mm f4.5 lens with either *Kodachrome* 64 and *Ektachrome* 200 (in 1983) or *Fujichrome* 100 (from 1984 to 1986) slide film.

This technique was first described for *Tursiops truncatus* by Würsig and Würsig (1977), and subsequently modified by Dorsey (1983) for minke whales, Sears, Williamson, Wenzel, Bérubé, Gendron and Jones (1990) for blue whales and Agler, Beard, Bowman, Corbett, Frohock, Hawvermale, Katona, Sadove and Seipt (1990) for fin whales.

This is the first published study of individually identified Bryde's whales and thus we will briefly describe the features used. Most of the individually identifiable Bryde's whales had one (58%) or more than one (25%) distinctive tear or notch in the trailing edge of the dorsal fin. The remaining identifiable individuals had notches in the tip (4%), or leading edge (4%) of the dorsal fin, had the dorsal fin completely torn off (4%), had an odd shaped dorsal fin (4%), or had obvious deformities such as a hunchback or a broken rostrum (1%). In the study area, Bryde's whales had less variable pigmentation patterns than the blue, fin or minke whales and rarely had noticeable scars. When present, scars and pigmentation patterns were only used as supplementary identifying features.

RESULTS

Relative abundance and numbers of identified individuals

In 1985/86, when research was conducted throughout most of a year, the four most frequently sighted mysticetes were the Bryde's, fin, minke and blue whale, in decreasing order of numbers of sightings (Fig. 4). However sighting effort was not distributed evenly throughout the year (Fig. 3) and periods of greatest fin whale abundance (see below) were under-sampled.

The mean number of identifications per identifiable individual for the entire study suggests that individual fin and blue whales are less resident to the study area than individual Bryde's and minke whales (Fig. 5).

In 1983, the first year of our study, we made an equal effort to photograph all individuals regardless of apparent identifiability. Thus (assuming no difference in behavior between identifiable and non-identifiable individuals) we were able to approximate the percentage of individuals distinctive enough to be identifiable with our methodology. We took 392 good quality photographs of Bryde's whales from which we made 138 (35.2%) positive identifications. The respective values for fin whales were 240 and 65 (27.1%). As was found by Sears *et al.* (1990), all blue whales sighted were distinctive enough for individual identification. Similarly the few minke whales seen were identifiable.

We photo-identified 9 individual blue whales, 148 fin whales, 160 Bryde's whales and 6 minke whales. Dividing the number of individual fin and Bryde's whales identified by the percentage of all individuals which were identifiable

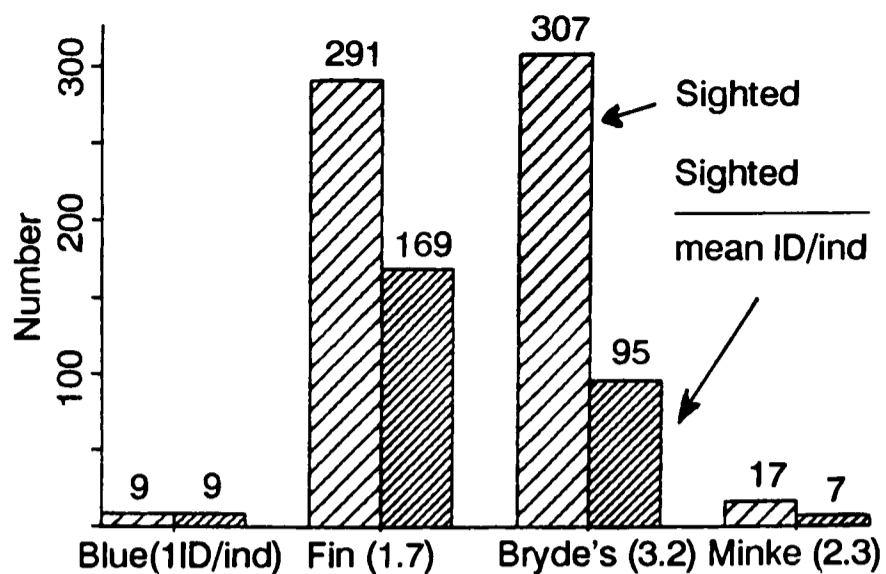

Fig. 4. The relative abundance of *Balaenoptera* whales in 1985-86. The number sighted during censuses is an indicator of relative occurrence of whales, but it is probably not representative of the relative number of individuals using the study area, since each species has different residency patterns. The number sighted, divided by the mean number of within-year sightings per identified individual, a measure of residency, is a better indicator of the relative number of individuals of each species using the study area.

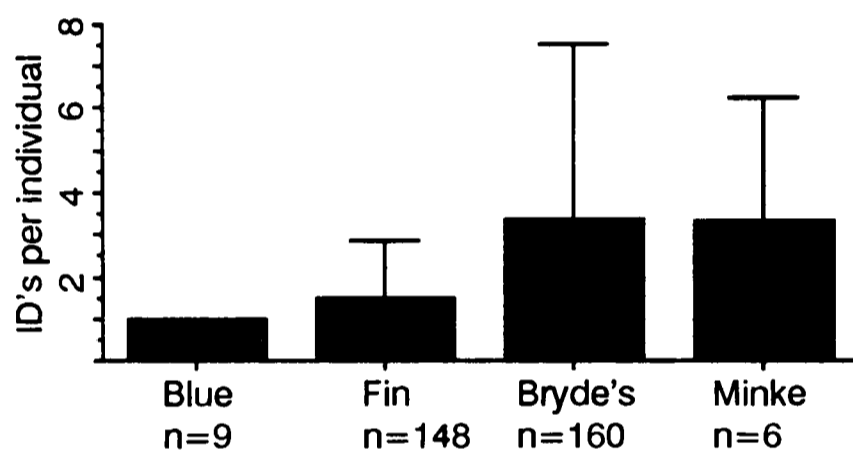

Fig. 5. The mean number of identifications per individual from all years combined. Differences between fin and Bryde's whales are significant (Mann-Whitney U, $P < 0.001$).

gives an estimate for the number of individuals which used the Canal de Ballenas between 1983 and 1986 of 546 fin whales and 454 Bryde's whales.

Seasonal distribution

To examine the seasonal distribution of the blue and minke whales we combined sightings from all years of field work and divided the number of individuals sighted each week by the number of hours of observations in that week (Fig. 2). Blue whales occurred in the study area primarily in April and May, but one individual was sighted in June and one cow/calf pair was sighted in October (just after the peak of sightings off central California (Calambokidis, Steiger, Cabbage, Balcomb, Ewald, Kruse, Wells and Sears, 1990)). Minke whales may be most abundant in the spring, but were sighted in all months of the year except those with less than 100 hours of boat time (Figs 2 and 3).

We observed fin and Bryde's whales in the study area throughout the year in waters ranging from 15-28°C. Fin whales were most abundant in late winter and spring (mean date of occurrence 20 April, circular standard deviation of 48 days). The mean number sighted per hour per week was negatively correlated with water temperature ($r = -0.530$, $df = 34$, $t_{13} = 3.645$, $P < 0.0005$ for 1985, and $r = -0.564$, $df = 18$, $t_{17} = 2.899$, $P < 0.005$ for 1984). Bryde's whales, in

contrast, were most abundant in summer and fall (mean date of occurrence 23 June, circular standard deviation 47 days). Their abundance was positively correlated with water temperature ($r=0.327$, $df=34$, $t_1=2.019$, $P<0.05$ for 1985 and $r=0.733$ $df=18$, $t_1=4.567$, $P<0.0005$ for 1984) (Fig. 2). Mean weekly counts of fin and Bryde's whales were not significantly correlated with each other.

Photo-identification matches with other areas

Between year matches of photo-identified blue, fin and Bryde's whales have been made between the study area and several locations in the Gulf of California (Table 2). One blue whale we identified in the Canal de Ballenas in the spring of 1985 was resighted in the fall of 1986 in Monterey Bay, off central California (Calambokidis *et al.*, 1990). These matches provide valuable information on the ranges of individual whales but provide little information on seasonal movements. Comparisons between identified fin or Bryde's whales from the Gulf and the North Pacific whales have not been made.

Table 2

Matches between the Canal de Ballenas and other areas expressed as No. matches / No. of individuals checked in the other area. Names are of the researchers who provided the photos.

	1 Bahia Kino Guaymas	2 Northern Gulf	3 Loreto B.C.S.	4 Central California
Blue	0/1	-	4-6/? R. Sears	1/? J. Calambokidis
Fin	2/12 L. Findley O. Vidal	1/4 G. Silber	-	
Bryde's	1/1 B. Agler		3/17 S. Flores L. Fleishcher	
Minke	-	-	-	-

Population composition

We combined data for all years, and looked at population composition of whales in the study area in two ways. First we used census data to estimate the percentage of adult and subadult whales that were females accompanied by a calf: Bryde's 7.5%; fin 1.0%; minke 3.5%; and blue 23.1%. Second we used photo-identification data to estimate the percentage of all adult and subadult identified individuals that were known to be females: Bryde's 10.6%; fin 2.7%; minke 16.7%; and blue 11.1% (Fig. 6).

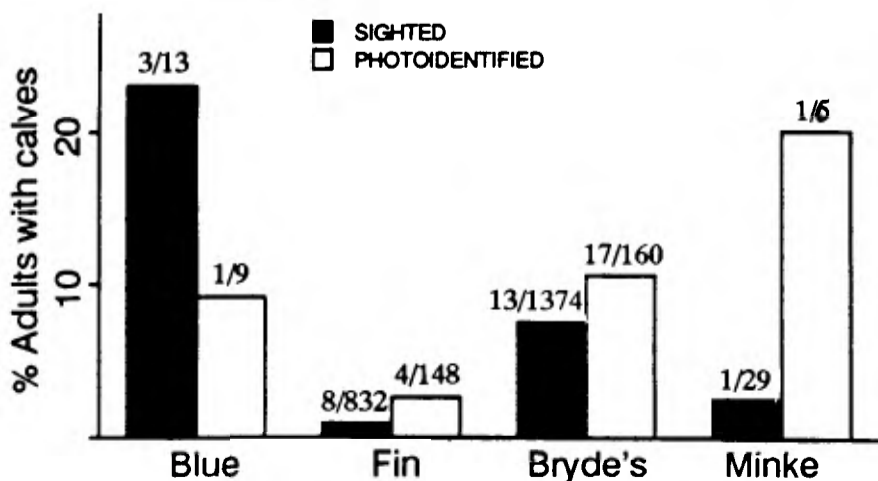

Fig. 6. The percentage of females accompanied by calves for each species of *Balaenoptera* whale. Data from all years combined for two different data sets – 1) sighting data from censuses and 2) from photo-identified individuals.

Differences between the sexes

Only in Bryde's whales were cow/calf pairs and known females abundant enough to examine differences between sexes. There is no apparent difference in within-year seasonal distribution of known females and unknown sex individuals from sighting data (Fig. 7). However, resighting data from known females suggest that they are more resident to the study area than Bryde's whales of undetermined sex, at least some of which are probably males. The mean number of identifications per known female Bryde's whale, 4.6 (78 identifications of 17 individuals), was significantly greater ($P<0.001$, Mann-Whitney U test) than the mean for undetermined sex whales, 1.9 (274 identifications of 143 individuals).

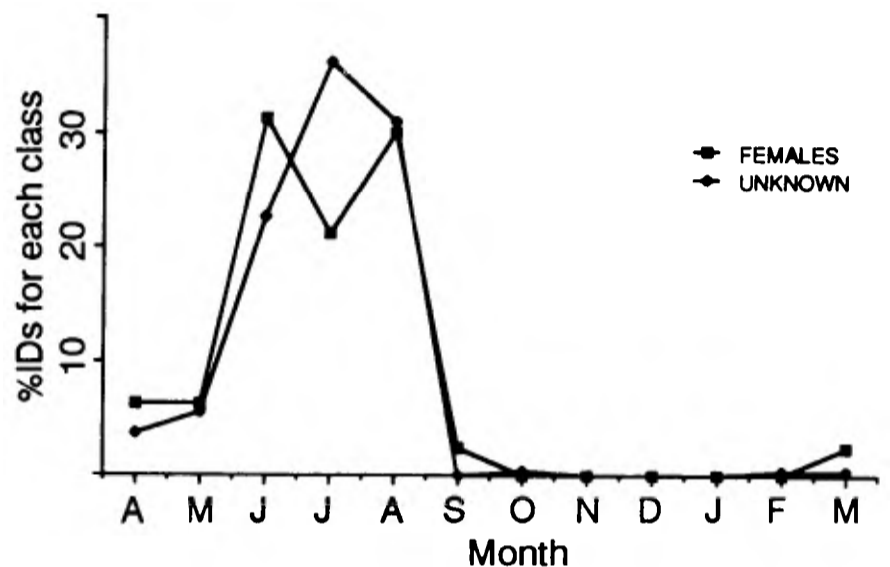

Fig. 7. The percent of all sightings of known individual females ($n=78$, open boxes) and known individuals of undetermined sex ($n=274$, closed triangles) from in each month. Data from all years combined.

Some Bryde's whales were so thin that their vertebral processes were protruding and their back had a distinctive corrugated, dorsally thin, appearance (Fig. 8a). Others appeared to be more robust and their back had a normal rounded, dorsally fat, appearance (Fig. 8b). We analyzed photographs of known individuals in which the anterior dorsal surface is clearly visible and found that females accompanied by a calf, and presumably lactating, have thinner blubber layers than do individuals of undetermined sex or known females which were not accompanied by a calf and were presumably immature, resting or pregnant (Table 3).



Fig. 8. (A) A female Bryde's whale, Flo, just after weaning her calf in July of 1984. The corrugated, dorsally thin, appearance of her back suggests that she is very thin. (B) The same individual in August of 1985. She is now at least 6 months pregnant and her back appears rounded or dorsally fat.

Table 3

The number of Bryde's whales which were dorsally thin and dorsally fat for three different reproductive classes.

	Undetermined Sex	Pregnant (4) or Resting (2)	Lactating	Total
Dorsally thin	3	0	12	15
Dorsally fat	17	6	5	28
Total	20	6	17	43

chi-squared = 16.24 *P* < 0.001

DISCUSSION

Relative abundance

Van Horne (1983) has shown that for small mammals, census data alone often give a distorted picture of both habitat importance and abundance. Our data on known individuals suggest that this is also true for *Balaenoptera* whales in the study area. The low resighting rates for blue and fin whales indicates that individuals use the Canal de Ballenas infrequently and that census data underestimate their abundance relative to that of Bryde's and minke whales, which have a higher resighting rate.

There are no estimates of the number of Bryde's whales in the Gulf of California. Aguayo *et al.* (1983) and Rojas, (1984) used census data to estimate a minimum population size for fin whales of 100 and 188 respectively. Our estimate from the number of photo-identified individuals divided by the estimated proportion of individuals which are identifiable is substantially higher for both fin (546) and Bryde's whales (454).

Many papers have commented on the large numbers of fin whales in the Gulf of California while mentioning Bryde's whales only in passing (e.g. Van Gelder, 1960; Wells *et al.*, 1981; Leatherwood *et al.*, 1982; Aguayo *et al.*, 1986). Our data, however, demonstrate that Bryde's whales were at least as abundant as fin whales in the Canal de Ballenas. Detailed studies off La Paz, B.C.S., in the Southern Gulf of California have also found relatively large numbers of Bryde's whales (J. Urbán pers. comm.; S. Flores pers. comm.). The small numbers of Bryde's whales reported in previous studies may be due to Bryde's whales being mistakenly identified as fin whales, or to these studies being conducted primarily in winter and spring when fin whales appear to be more abundant than Bryde's whales.

Seasonal distribution

Blue whales are found in the southern Gulf primarily between February and June with a peak in sightings between mid-March and mid-April (Sears *et al.*, 1987; Vidal *et al.*, 1986). They have also been reported in the Gulf during the fall (Leatherwood *et al.*, 1982; Yochem and Leatherwood, 1985). Matches of photo-identified individuals confirm that blue whales migrate between the Canal de Ballenas, Loreto (Baja California Sur) and the Pacific coast of central California where they peak in abundance between mid-August and mid-October (Table 2; Sears *et al.*, 1987; Calambokidis *et al.*, 1990). Except for the two individuals sighted in October (a cow/calf pair) our sightings support this general pattern.

Minke whales in some temperate and sub-tropical areas are present year-round (Leatherwood *et al.*, 1982; Dorsey, 1983), and in other areas their migrations are more protracted than those of sei and fin whales (Best, 1982). In

the Canal de Ballenas minke whales are probably present in all months of the year. Identified individuals have a relatively high resighting rate, although much lower than was found for Washington state (Dorsey, 1983).

The seasonal distribution and apparent water temperature preferences of fin and Bryde's whales found in the Canal de Ballenas are similar to those found in other parts of the world. Ohsumi (1977) showed that 97% of the fin whales taken in the North Pacific by the Japanese fleet were in water colder than 15°C and 92% of the Bryde's whales were taken in water 18°C or warmer. The distribution of Bryde's whales is often considered to be limited by the 20°C isotherm (Omura, 1959; Privalikhin and Berzin, 1978). However, in coastal upwelling areas the inshore form is found in temperatures as low as 12°C and frequently in waters between 15° and 18°C (Best, 1960; Gallardo, Arcos, Salamanca and Pastene, 1983).

Bryde's whales are generally considered less migratory than their congeners but are known to undertake limited north-south migrations in several areas (Best, 1960; 1977; Valdivia, Franco and Ramirez, 1981; Leatherwood & Reeves, 1983). During the winter and spring, Bryde's whales most likely concentrate in other parts of the Gulf of California or disperse over a large area. Although concentrations of Bryde's whales, including some individuals identified in the Canal de Ballenas, have been reported in Loreto during the summer (Flores and Fleischer, 1987; 1988), winter and spring concentrations have not been recorded.

If the fin whales in the Gulf of California are a resident or isolated population, then the low numbers of fin whales in the Canal de Ballenas we observed during the summer and fall are curious because summer sea surface temperatures are 2–5° lower there than in any other part of the Gulf of California (Badan-Dangon *et al.*, 1985; Alvarez-Borrego, 1983). Furthermore, Urbán, Auriolles and Aguayo (1988) reported that 77.4% of all fin whale sightings in the southern Gulf of California were in the winter and spring; a similar seasonal distribution is seen in the Guaymas region of the eastern Gulf (L. Findley, pers. comm.). If, however, they are part of the eastern North Pacific stock, the observed seasonal distribution makes more sense. Tagging studies in the eastern North Pacific (discussed in Leatherwood *et al.*, 1982) indicate that fin whales summer from the Aleutian Islands and Gulf of Alaska down to central California and winter from California south (see also Gambell, 1985).

The larger scale seasonal distribution of fin and Bryde's whales in the Gulf of California could be better understood by: (1) conducting simultaneous studies in several parts of the Gulf using consistent photo-identification and censusing methodology; (2) pooling existing data on abundance and seasonal distribution from Gulf of California census cruises and analyzing it in a consistent manner; and (3) making a comprehensive effort to compare balaenopterid photo-identification data from the rest of the Gulf of California and the North Pacific with our data from the Canal de Ballenas.

Population composition

Sex and/or age segregation has been inferred from catch data for fin (Laws, 1961; Martin, 1982) and minke whales (Jonsgård, 1962; Kasamatsu and Ohsumi, 1981; Best, 1982). The fact that cow/calf pairs made up only 1% of the fin whales observed over the course of this study indicates that the Canal de Ballenas is used more heavily by

immatures, resting females, or adult male fin whales. Bryde's whale cow/calf pairs, in contrast, make up over 7% of all sightings. This is close to the 9% observed by Rice (1979) in the equatorial eastern Pacific.

The pattern of greater residency observed amongst known female Bryde's whales is fairly common in mammals. Whether it is due to the different energetic demands experienced by males and females (Clutton-Brock, Guinness and Albon, 1982), the general tendency for males to emigrate from their natal territory (Lee and Cockburn, 1985; Eisenberg, 1981), or differing reproductive strategies (Sherman, 1981), is not clear.

The tendency for lactating females to be thinner than pregnant or resting females and undetermined sex whales indicates that lactation and other forms of maternal investment are a substantial energetic cost for female Bryde's whales, as has been found in blue, fin, and sei whales (Lockyer, 1981; 1987).

Best (1977) has demonstrated the existence of sympatric offshore and inshore forms of Bryde's whale off South Africa. The offshore form is heavily scarred, has a peak of conception in autumn and is primarily planktivorous. The smaller inshore form has very little scarring, has a relatively unrestricted breeding season and is primarily piscivorous. These two forms also occur in the western North Pacific (Omura, 1977). As off South Africa, the offshore form appears to feed primarily on plankton and is heavily scarred, while the inshore form is primarily piscivorous and relatively free of scarring (Kawamura and Satake, 1976).

Limited evidence suggests that the inshore form may be present off Baja California (IWC, 1977) and our own data support this. Analysis of photographs as well as surface and subsurface observations of Bryde's whales in the Canal de Ballenas show an almost total absence of scarring. Bryde's whales in the Canal de Ballenas fed primarily on fish (Tershy and Breese, 1987). Calves of various sizes were seen at the same time throughout the year (Breese and Tershy, 1987).

ACKNOWLEDGEMENTS

We would like to thank the Mexican Secretaria de Pesca for providing permit No's. 3099, 1141 and 1283 and allowing us to conduct research in Mexico. This research was funded by the University of California, Santa Cruz, Environmental Field Program, UCSC Chancellor's Discretionary Fund, UC President's Undergraduate Fellowship, UCSC Biology Board, American Cetacean Society Monterey and Los Angeles Chapters, Lerner-Grey Fund for Marine Research, Sigma Xi Grants-in-Aid of Research, and the Packard Fund. We are grateful to James Estes (U.S.F.W.S., National Ecology Research Center, Institute for Marine Sciences, 272 Applied Sciences Building, University of California, Santa Cruz, CA 95064) and Bernd Würsig (Moss Landing Marine Laboratories, P.O. Box 450 Moss Landing, CA 95039-0450) for their insightful reviews of the paper. Our heartfelt thanks go out to the people who made this research possible: Ellie, Russell and Bill Tershy; our advisors Ken Norris, Bernd Würsig and Roger Luckenbach; our local support network Antonio Resendiz, Marcos and Gloria Blanca, Eliborio and Chabela Valenzuela, José Mercadé, Raúl and Carolina Espinosa and Bonnie and Grover Starr; and especially our assistants Ellen Van Gelder, Vince Dollarhide, Greg Meyer, Eileen Murphy, Alejandro

Acevedo, Arturo Lopez, Sergio Flores, Jorge Ramirez, Guillermo Sanchez, Craig Hansen, Tim Rusk, Debbie Smalheer, Jackie Feldman, Joe Terrazino, Carl Paulsen, Jane Rowe, Cheryl Heidenreich, Beth Adams and Drew Anderson. We would like to extend special thanks to the crew of *Islas de Pajaros II* without whom our research would have ended prematurely.

REFERENCES

- Aglar, B.A., Beard, J.A., Bowman, R.S., Corbett, H.D., Frohock, S.E., Hawvermale, M.P., Katona, S.K., Sadove, S.S. and Seipt, I.E. 1990. Finback whale, *Balaenoptera physalus*, photographic identification: methodology and preliminary results from the western North Atlantic. Paper SC/A88/ID20 (published in this volume).
- Aguayo-L., A., Findley, L., Rojas-B., L. and Vidal, O. 1983. The population of fin whales (*Balaenoptera physalus*) in the Gulf of California, México. Abstracts of the Fifth Biennial Conference on the Biology of Marine Mammals, 27 November – 1 December, Boston, MA.
- Aguayo-L., A., Urbán-R., J., Sánchez-T., R. and Rojas-B., L. 1986. Diversity and distribution of the cetaceans in the Golfo de California. Abstracts of the XI Reunión Internacional sobre Mamíferos Marinos, 2–6 April, Guaymas, Sonora, México.
- Alvarez-Borrego, S. 1983. Gulf of California. pp. 427–449. In: B.H. Ketchum (ed.) 1983. *Estuaries and Enclosed Seas*. Elsevier Press. Amsterdam.
- Alvarez, L.G., Badan-Dangon, A. and Robles, J.M. 1984. Lagrangian observations of near-surface currents in Canal de Ballenas. *CalCOFI Rep.* 25:35–42.
- Badan-Dangon, A., Koblinsky, C.J. and Baumgartner, T. 1985. Spring and summer in the Gulf of California: observations of surface thermal patterns. *Oceanol. Acta* 8(1):13–22.
- Balcomb, K.C., Villa-R., B. and Nichols, G. 1979. Marine mammals in the Cortez Sea. Proc. 4th International Conference on Gray Whales, La Paz, 16 February.
- Best, P.B. 1960. Further information on Bryde's whale (*Balaenoptera edeni*) from Saldhana Bay, South Africa. *Norsk Hvalfangsttid.* 49:201–12.
- Best, P.B. 1977. Two allopatric forms of Bryde's whale off South Africa. *Rep. int. Whal. Commn* (special issue 1):10–38.
- Best, P.B. 1982. Seasonal abundance, feeding, reproduction, age and growth in minke whales off Durban (with incidental observations from the Antarctic). *Rep. int. Whal. Commn* 32:759–86.
- Breese, D. and Tershy, B.R. 1987. Residency patterns in female Bryde's whales in the Gulf of California, Mexico. Abstracts of the Seventh Biennial Conference on the Biology of Marine Mammals, 5–9 December, Miami, FL.
- Calambokidis, J., Steiger, G.H., Cabbage, J.C., Balcomb, K.C., Ewald, C., Kruse, S., Wells, R. and Sears, R. 1990. Sightings and movements of blue whales off central California 1986–88 from photo-identification of individuals. Paper SC/A88/ID24 (published in this volume).
- Clutton-Brock, T.H., Guinness, F.E. and Albon, S.D. 1982. *Red Deer: Behavior and Ecology of Two Sexes*. University of Chicago Press, Chicago. 377 pp.
- Cummings, W.C., Thompson, P.O. and Ha, S.J. 1985. Sounds from Bryde, *Balaenoptera edeni*, and finback, *B. physalus*, whales in the Gulf of California. *Fish. Bull.*, US 84:359–70.
- Dorsey, E.M. 1983. Exclusive adjoining ranges in individually identified minke whales (*Balaenoptera acutorostrata*) in Washington State. *Can. J. Zool.* 61:174–81.
- Eisenberg, J.F. 1981. *The Mammalian Radiations. An Analysis of Trends in Evolution, Adaptation, and Behavior*. Univ. Chicago Press, Chicago. 610 pp.
- Flores, S. and Fleischer, L. 1987. Distribution and occurrence of Bryde's whales (*Balaenoptera edeni*) in the Gulf of California, Mexico. Abstracts of the XII Reunión Internacional sobre el Estudio de los Mamíferos Marinos, 22–25 April, La Paz, B.C.S., México.
- Flores, S. and Fleischer, L. 1988. Occurrence, distribution and relative abundance of Bryde's whales (*Balaenoptera edeni*) in the Gulf of California, Mexico. Abstracts of the XIII Reunión Internacional sobre el Estudio de los Mamíferos Marinos, 6–9 April, La Paz, B.C.S., México.

- Gallardo, V.A., Arcos, D., Salamanca, M. and Pastene, L. 1983. On the occurrence of Bryde's whales (*Balaenoptera edeni* Anderson, 1878) in an upwelling area off central Chile. *Rep. int. Whal. Commn* 33:481-8.
- Gambell, R. 1985. Fin Whale, *Balaenoptera physalus* pp 172-192 In S. Ridgeway and R. Harrison (eds.) 1985. *Handbook of Marine Mammals*. Academic Press, London.
- International Whaling Commission. 1977. Report of the special meeting of the scientific committee on Sei and Bryde's whales. *Rep. int. Whal. Commn* (special issue 1):1-9.
- Jonsgård, A. 1962. Population studies on the minke whale, *Balaenoptera acutorostrata*, Lacépède. pp. 159-67 In: E.E. Le Cren and M. W. Holdgate (eds). *The Exploitation of Natural Animal Populations*. J. Wiley & Sons. N.Y.
- Kasamatsu, F. and Ohsumi, S. 1981. Distribution pattern of minke whales in the Antarctic with special reference to the sex ratio in the catch. *Rep. int. Whal. Commn* 31:345-8.
- Kawamura, A. and Satake, Y. 1976. Preliminary report on the geographical distribution of the Bryde's whale in the North Pacific with special reference to the structure of filtering apparatus. *Sci. Rep. Whales Res. Inst., Tokyo* 28:1-35.
- Laws, R.M. 1961. Reproduction, growth and age of southern fin whales. *Discovery Rep.* 31:327-486.
- Leatherwood, S., Reeves, R.R., Perrin, W.F. and Evans, W. 1982. *Whales, Dolphins and Porpoises of the Eastern North Pacific and Adjacent Arctic Waters. A Guide to Their Identification*. NOAA Tech. Rept. NMFS Circular 444. U.S. Dept. of Commerce. 245 pp.
- Leatherwood, S. and Reeves, R.R. 1983. *The Sierra Club Handbook of Whales and Dolphins*. Sierra Club Books, San Francisco. 302 pp.
- Lee, A.K. and Cockburn, A. 1985. *Evolutionary Ecology of Marsupials*. Cambridge University Press, Cambridge. 274 pp.
- Lockyer, C. 1981. Growth and energy budgets of large baleen whales from the Southern Hemisphere. In: *Mammals in the Seas* 3:379-487. *FAO Fish. Ser. 5*. [Mammals in the Seas] 3:379-487.
- Lockyer, C. 1987. The relationship between body fat, food resource and reproductive energy costs in North Atlantic fin whales (*Balaenoptera physalus*). *Symp. Zool. Soc. Lond.* 57:343-61.
- Martin, A.R. 1982. Influence of date and position of capture on the length of fin whales taken by Iceland. *Rep. int. Whal. Commn* 32:331-4.
- Ohsumi, S. 1977. Bryde's whales in the pelagic whaling ground of the North Pacific. *Rep. int. Whal. Commn* (special issue 1):140-9.
- Omura, H. 1959. Bryde's whale from the coast of Japan. *Sci. Rep. Whales Res. Inst., Tokyo* 14:1-33.
- Omura, H. 1977. Review of the occurrence of Bryde's whale in the Northwest Pacific. *Rep. int. Whal. Commn* (special issue 1):88-91.
- Privalikhin, V.I. and Berzin, A.A. 1978. Abundance and distribution of Bryde's whale (*Balaenoptera edeni*) in the Pacific Ocean. *Rep. int. Whal. Commn* 28:43-4.
- Rice, D.W. 1977. Synopsis of biological data on the sei whale and Bryde's whale in the eastern North Pacific. *Rep. int. Whal. Commn* (special issue 1):92-7.
- Rice, D.W. 1979. Bryde's whales in the equatorial Eastern Pacific. *Rep. int. Whal. Commn* 29:321-4.
- Robinson, M.K. 1973. Atlas of monthly mean sea surface and subsurface temperatures in the Gulf of California, Mexico. *San Diego Soc. Nat. Hist. Mem.* 5.
- Roden, G.I. 1964. Oceanographic aspects of Gulf of California. In: T.H. van Andel and G.G. Shor, Jr. (eds.), *Marine Geology of the Gulf of California*. Amer. Assoc. Petrol. Geol. Mem. 3.
- Rojas-B., L. 1984. Presencia y distribución del rorcual común, *Balaenoptera physalus* en el Golfo de California, México. Licenciado thesis, Univ. Nacional Autónoma de México, México City. 157 pp.
- Salinas-Z., M. A. and Bourillon-M., L. F. 1988. Taxonomía, Diversidad, y Distribución de los Cetáceos de la Bahía de Banderas, México. Licenciado thesis. Univ. Nacional Autónoma de México. México City. 211 pp.
- Sears, R., Williamson, J.M., Wenzel, F.W., Bérubé, M., Gendron, D. and Jones, P. 1990. Photographic identification of the blue whale (*Balaenoptera musculus*) in the Gulf of St Lawrence, Canada. Paper SC/A88/ID23 (published in this volume).
- Sears, R., Bérubé, M. and Gendron, D. 1987. A preliminary look at the distribution and migration of blue whales (*Balaenoptera musculus*) in the Northeast Pacific, based on the photo-identification of individuals. Abstracts of the Seventh Biennial Conference on the Biology of Marine Mammals, 5-9 December, Miami, FL.
- Sherman, P.W. 1981. Reproductive competition and infanticide in Belding's ground squirrels and other animals. pp. 311-31 In: R.D. Alexander and D.W. Tinkle (eds) *Natural Selection and Social Behavior*. Chiron Press. N.Y.
- Tershy, B.R. 1984. The occurrence and behavior of fin whales in the Gulf of California. Senior thesis, Univ. California, Santa Cruz. 106 pp.
- Tershy, B.R. and Breese, D. 1987. Body size, diet, habitat use, and social behavior in *Balaenoptera* whales in the Gulf of California, México. Abstracts of the Seventh Biennial Conference on the Biology of Marine Mammals, 5-9 December, Miami, FL.
- Urbán-R., J., Aurióles-G., D. and Aguayo-L., A. 1988. The fin whale (*Balaenoptera physalus*) in the southern Gulf of California. Abstracts of the XIII Reunión Internacional sobre el Estudio de los Mamíferos Marinos, 6-9 April, La Paz, B.C.S.
- Valdivia, J., Franco, F. and Ramirez, P. 1981. The exploitation of Bryde's whales in the Peruvian Sea. *Rep. int. Whal. Commn* 31:441-8.
- Van Horne, B. 1983. Density as a misleading indicator of habitat quality. *J. Wildl. Manage.* 47:893-901.
- Van Gelder, R.G. 1960. Results of the Puritan-American Museum of Natural History Expedition of western Mexico, 10 Marine Mammals from the coasts of Baja California and the Tres Marias Islands, Mexico. *Amer. Mus. Novitates* 1992:2-15.
- Vidal, O., Aguayo, A., Findley, L., Robles, A., Bourillon, L., Vomend, Y., Turk, P., Garate, K., Maronas, L. and Rosas, J. 1985. Cetacean sightings during a cruise in the upper Gulf of California, spring 1984. Abstracts of the X Reunión Internacional para el Estudio de los Mamíferos Marinos, 24-27 March, La Paz, B.C.S., México.
- Vidal, O., Findley, L., Robles, A., Carvallo, G. and Maldonado, J. 1986. Observations on the distribution, respiratory rhythm and behavior of blue whales in the Gulf of California. Abstracts of the XI Reunión Internacional Sobre Mamíferos Marinos, 2-6 April, Guaymas, Sonora, México.
- Wells, R.W., Würsig, B.W., and Norris, K.S. 1981. A survey of the marine mammals of the upper Gulf of California, Mexico, with an assessment of the status of *Phocoena sinus*. Final Report to the Marine Mammal Commission. MMC-79/07. 51 pp.
- Wilson, E.O. 1975. *Sociobiology*. Harvard Univ. Press. Cambridge, Massachusetts. 697pp.
- Würsig, B.W. and Würsig, M. 1977. The photographic determination of group size, composition, and stability of coastal porpoises (*Tursiops truncatus*). *Science*. 198:755-756.
- Yochem, P. and Leatherwood, S. 1985. Blue Whale, *Balaenoptera musculus*. pp. 193-240 In: S. Ridgeway and R. Harrison, (eds). *Handbook of Marine Mammals* Academic Press. London.

Assessing Sperm Whale Populations Using Natural Markings: Recent Progress

Hal Whitehead

Department of Biology, Dalhousie University, Halifax, Nova Scotia, Canada B3H 4J1

ABSTRACT

Detailed research on living sperm whales using photo-identification was started in 1982. The data from the studies carried out since then have allowed advances in our understanding of the population biology of sperm whales. Males were found not to hold harems as previously assumed. Instead they adopted a 'searching strategy'. The number of mature males found on the breeding grounds was much lower than expected, suggesting that males may not breed every season. Some population parameters have been estimated successfully from photo-identification and other non-lethal data. The mean school size and the size of breeding males are in general agreement with previous estimates. However, estimates from the Galápagos Islands of the proportion of females in a breeding school and the calving rate suggest a lower reproductive rate than found in previous studies. This might be because of the presence of older females with decreased reproductive rates, and post-reproductive females, in relatively unexploited schools. Useful estimates of population size and stock structure for the female sperm whales off the Galápagos Islands are beginning to be obtained from photo-identification data.

INTRODUCTION

Compared to many of the more coastal cetaceans, the use of photo-identification techniques on sperm whales (*Physeter macrocephalus*) is in its infancy. Between 1982 and 1984, during the World Wildlife Fund Indian Ocean Sperm Whale Study, it was shown that sperm whales could be identified individually from photographs of their flukes and dorsal fins (Whitehead and Gordon, 1986; Gordon, 1987a and b). The presence of a callus on the dorsal fin is also a good indicator of a mature female (Kasuya and Ohsumi, 1966; Whitehead and Gordon, 1986; Gordon, 1987a). Arnborn (1987) made a thorough study of sperm whale photo-identification techniques, primarily from flukes, using a large sample (793 photographs of flukes) collected off the Galápagos Islands in 1985. His analysis suggested that at least 91% of sperm whales can be individually identified from good quality photographs (those with sufficiently large, clear and favourably orientated images) of their flukes. Another large sample (1,661 photographs of flukes) was obtained from the Galápagos in 1987, and numbers of flukes have also been photographed off the Azores, Norway, Nova Scotia and the West Indies (Whitehead and Waters, 1990; Arnborn, Gordon and Waters, 1988). These have allowed Arnborn *et al.* (1988) to show that sperm whales in different oceans have reasonably similar numbers and types of fluke markings, and that these markings show little change over periods of up to two years.

The purpose of this paper is to describe how identifications of individual sperm whales from photographs of natural markings, in conjunction with other non-lethal techniques, can be used to study the size and dynamics of sperm whale populations. From a management viewpoint, uncertainty about the population biology of a species can be usefully separated into three categories: (1) form of population model; (2) parameters of model; and (3) population size. Although not a perfect categorisation of the problems facing cetacean population biologists (where do we place uncertainty about stock identity?), this is a useful framework to describe recent attempts at sperm whale population assessment. This paper will look at all three forms of uncertainty about

sperm whale populations, discuss how studies of naturally marked animals are trying to help reduce it, and, in a few instances, estimate how much more effort is required to obtain accurate estimates. In some respects this paper is an update of Whitehead and Gordon's (1986) discussion of the potential of non-lethal techniques for assessing and modelling sperm whale populations.

THE MODEL

The 'sperm whale model' as it was developed and used by the IWC Scientific Committee (e.g. IWC, 1982) is a collection of assumptions about the natural history of sperm whales. It has been used by the Scientific Committee to examine the dynamics of sperm whale populations. Some parts of the sperm whale model are generally acceptable, while others, especially those concerned with density-dependence, are more questionable.

Male mating strategies

With sperm whales, there has been special concern about a particular form of density-dependence: how does a relative decrease in the number of mature male sperm whales (caused by selection for males in the whaling industry) affect the pregnancy rate of the females? In the sperm whale model, this is modelled by assuming that male sperm whales hold harems with one mature male per group of females, and that as long as there are sufficient mature males present for there to be one per group of females, plus a few in reserve (the 'harem reserve ratio'), the pregnancy rate of the females is not affected by a reduction in male abundance.

From the 1985 Galápagos data, Whitehead and Arnborn (1987) found that individually identified male sperm whales associated with a variety of groups of females and *vice versa*. The average duration of an interaction between a male and a group of females was only a few hours. These results have recently been confirmed from analysis of the 1987 Galápagos data (Whitehead and Waters, 1990). This implies that the males are moving between groups of females searching for oestrous females rather than holding harems, and Whitehead and Arnborn (1987) have shown

that if the males were attempting to maximise their reproductive success we would generally expect them to do this. Changing the sperm whale model to incorporate a 'searching' male mating strategy suggests that the female pregnancy rate is more resilient to relative male depletion than in the traditional 'harem' model (May and Beddington, 1980; Whitehead, 1987).

Proportion of mature males on breeding grounds

Another potentially important observation during the Galápagos studies was the low proportion of mature males on the breeding grounds. At the height of the mating season, which seems to be April-May, mature males formed about 2–3% of the population (Whitehead, Weilgart and Waters, 1989). A similar low proportion of mature males seems to be the case on other tropical breeding grounds (Whitehead, 1987). Using life history data presented by Best (1979), Whitehead (1987) showed that the percentage of mature males expected in a population of mature males and breeding groups of females is about 22%.

Six possible reasons have been suggested for this discrepancy (Whitehead, 1987): (1) relative depletion of males by the whaling industry; (2) the Galápagos may not be the whales' principal mating ground; (3) mating may take place at a season other than when the studies were taking place; (4) males may distribute themselves unevenly between breeding grounds; (5) males may not breed every year; and (6) males may have higher natural mortality than females (Ralls, Brownell and Ballou, 1981).

Data from the 1987 Galápagos study (Whitehead *et al.*, 1989) suggest that the sperm whales observed off the Galápagos probably mate during the period of the studies and in the Galápagos area, so that factors (2) and (3) are unlikely to be important. Best (1987) assumes equal natural mortality for males and females. If instead, the differential mortalities and ages at sexual maturity assumed in IWC (1982) are used, the proportion of mature males in a population of mature males and breeding groups of females is about 16% (following Whitehead (1987)), still much greater than the observed 2–3%. Sperm whales may not distribute themselves evenly between breeding grounds (factor 4), but the principal reasons for the low number of observed breeding males are probably factors (1) and (5): relative depletion caused by whaling (IWC, 1981), and mature males not taking part in breeding every year perhaps because of energetic constraints (Whitehead and Arnbohm, 1987).

If mature males do not take part in breeding every year, there are major consequences for assessing the effects of male depletion on female pregnancy rate (Whitehead, 1987). We need to know the movements of individual males over periods of several years. If attachment problems can be solved, long-term satellite-link radio telemetry may help to determine these movements.

PARAMETERS OF THE MODEL

The considerations which have been discussed in the previous section reinforce arguments previously made in the Scientific Committee of the IWC (e.g. IWC, 1983) that the current 'sperm whale model' is not realistic and thus not particularly useful – it needs to be amended. An amended model would have parameters different from those in the current model. These might include factors such as the ratio of the travel time of breeding males

between groups of females to the oestrous period of the females (Whitehead, 1987) and the probability that a mature male enters the breeding ground in any season. However it would also include most of the parameters in the current model. Therefore, as an illustration of how well we can estimate population parameters using data collected from living sperm whales, I will consider those in the current model, or potential substitutes.

Age at recruitment for males and females

Recruitment to an exploitable stock is usually defined by a minimum length requirement. So, to examine recruitment we need length (or possibly age) distribution data and an age-length key. Lengths of sperm whales can be estimated with reasonable accuracy from photographic measurements (Gordon, 1990) and, possibly, from analysis of the structure of their click vocalisations (Adler-Fenchel, 1980). Waters & Whitehead (1990) have analysed the distribution of 637 photographically estimated lengths of sperm whales from the Galápagos Islands. In contrast to length measurements made during catching operations, these photographically obtained length distributions are unlikely to be biased because of factors such as gunner selectivity or systematic mismeasurement of whales near minimum legal lengths (Cooke, de la Mare and Beddington, 1983).

Age-length keys have been constructed for sperm whales using catch data (e.g. Ohsumi, 1977), but they can also be a product of long-term studies of living whales, if identified whales are measured in two or more time periods, as has been done for right whales (*Eubalaena australis*) by Whitehead and Payne (1981). We have been able to identify individual sperm whales over periods of two years, so that if reasonable samples of identified and measured animals can be collected at each of several time periods, it should be possible to construct an age-length key for sperm whales. The time taken to achieve this will depend on the rate at which repeated (over more than one year) measurements of the same individual can be made.

Age at social maturity for males and females

With long-term studies of individual animals for which some birth dates are known, the age at which females first give birth can be determined (e.g. Clapham and Mayo, 1987a; Glockner-Ferrari and Ferrari, 1990). For males, the age at which animals begin to take part in mating behaviour can be noted, but this may not be indicative of effective reproduction. The new DNA techniques (Hoelzel and Dover, 1989) theoretically allow paternity to be established but large data sets from calves and potential fathers of known age would be necessary for this to permit a direct assessment of the age at social maturity for males. These methods, based on long-term studies of known age animals, are far from realisation at present with sperm whales, and will be harder than for most other large whale species mainly because of the greater size of sperm whale populations and the greater ages at social maturity.

Less direct, but probably more feasible, approaches are to examine the lengths of females that have calves, and of males that take part in reproductive behaviour or for whom paternity of a calf can be established. These lengths can be converted into ages using age-length keys. Whitehead and Waters (1990) found the minimum size of mature males on the Galápagos breeding grounds to be 12.8m which is equivalent to 22 years old using Ohsumi's (1977)

age-length key. This is not significantly different from the 25 years assumed by the sperm whale model for the minimum age of breeding males.

Natural mortality

Accurate estimates of natural mortality are hard to obtain. With sufficient data, they can come from mark-recapture data (Buckland, 1990) or from a length distribution if an age-length key is available together with information on the rate of increase of the population. Either way, it is unlikely that we will have accurate estimates of the natural mortality of sperm whales from non-lethal data in the near future.

Mean school size

Good estimates of the mean size of female schools are available from the analyses of the Galápagos data. These were calculated from Schnabel mark-recapture estimates on the photo-identification data (Whitehead and Waters, 1990). The median and mean numbers of individuals, excluding first year calves, per school ('school' = 'group' in the terminology of Whitehead and Waters (1990)), for both the Galápagos 1985 and 1987 data sets were all between 21–22 animals.

Percentage of mature females per school

Using the proportions of individuals with/without a callus as a guide, Gordon (1987a) compared the observed proportion of mature females per school with those suggested by Best (1979). Gordon (1987a) found that the proportion of animals with calluses off Sri Lanka agreed with what would be expected from a 'tropical population' consisting of both groups of females and groups of immature individuals. For the Galápagos data, Waters and Whitehead (1990) found that both the proportion of calluses and the length distribution were consistent with a lower calving rate and higher proportion of females per school, than can be derived from the literature.

Harem reserve ratio

The results of Whitehead and Arnborn (1987) and Whitehead and Waters (1990) show the harem reserve ratio to be inappropriate parameter. As an indicator of the proportion of mature males in the population necessary to ensure that oestrous females are mated, it might be replaced by the ratio of the mean time interval between successive encounters of schools of females by a mature male on the breeding grounds to the oestrous period of a female (Whitehead, 1987). The oestrous period of the females will be difficult to determine, but is unlikely to vary much. On the other hand the numerator of this ratio, the 'search time' for mature males, can be roughly estimated from the type of data collected off the Galápagos, as done by Whitehead and Arnborn (1987). More accurate estimates of search time could come from radio tracking of individual males or following the movements and social interactions of a male acoustically as it passes through a large array of hydrophones. It is the search time for males that is likely to vary most between different breeding areas and time periods, and thus lead to different pregnancy rates for females.

Pregnancy rate

Ideally, the rate at which females give birth is obtained from calving histories of known animals (Clapham and Mayo, 1987b; Glockner-Ferrari and Ferrari, 1990; Payne, Rowntree, Perkins, Cooke and Lankester, 1990). This will be hard for sperm whales because their large population sizes make resightings of known individuals less frequent and because calves often accompany adults which are not their mothers (Gordon, 1987a; Arnborn and Whitehead, 1989).

An alternative is to examine the ratio of first year calves to mature females. In the Galápagos data, this was done for the five groups of females for which it appeared that almost all members of the group were visible at one time (i.e. the maximum number of whales seen at any time corresponded with the estimated group size from Schnabel mark-recapture estimates of group size using fluke identifications – Whitehead and Waters, 1990), and thus the number of first-year calves could be determined accurately. Observations in June 1987, when new-born calves began to be observed, and thus 'first-year calves' might include two year-classes, were not used. The calving rate was calculated as follows:

$$\frac{\text{Maximum number of calves seen at any time}}{\text{Group size} \times \text{Proportion of group which are mature females}}$$

The results, given in Table 1, suggest a mean calving rate of 0.065 calves/year, or a mean inter-calf interval of 15.5 years. Analysis of length distributions suggests even lower calving rates, 0.02–0.04 calves/year (Waters and Whitehead, 1990). This is a considerably lower calving rate than suggested by data from the whaling industry (Best, Canham and Macleod, 1984). In contrast Gordon (1987a) found rather more calves off Sri Lanka than would be expected from the sperm whale model, although as he points out, his calculations may be biased.

Table 1

Calving rates off the Galápagos. This Table gives for those groups of females for which it appeared that almost all members of the group were visible at one time: the group identity number, the year observed, the Schnabel population estimate with its estimated standard error in parentheses, the maximum number of whales (excluding first year calves) and first year calves seen at any time (all, except calves, from Whitehead and Waters, 1990), and the calving rate per mature female, calculated as explained in the text.

Group ID no.	Year	Population estimate (SE)	Maximum no. seen	Maximum calves seen	Calves per mature female
G5	1985	16.3 (1.5)	18	1	0.079
G7	1985	22.3 (4.4)	25	1	0.057
H1	1987	17.2 (0.1)	17	1	0.075
H3	1987	21.2 (0.2)	22	0	0
H13	1987	22.2 (1.3)	21	2	0.116
Total		99.2	103	5	0.065

Density dependent exponent

In looking at the response of sperm whale populations to the cessation of whaling, or to its resumption, we should also consider traditional density dependent relationships: how do population parameters respond to changing overall population densities? It is extremely difficult to obtain

information on this from whale populations subject to protection or sustained exploitation as there is unlikely to be much change in population density except in the very long term. Even in cases where populations have been drastically reduced over relatively short periods, results are problematic (e.g. Mizroch and York, 1985).

Indications of the magnitude of density-dependent effects might possibly be obtained if changes in population parameters (e.g. birth rate) can be related to natural variations in food supply, such as those resulting from El Niño events. Whitehead, Papastavrou and Smith (1989) have found that the rate of observing faeces, which should be a function of food availability, is related to environmental conditions. In some circumstances, the reaction of a population parameter to a natural halving of the feeding rate might be equivalent to its response to the doubling of the population size.

Whitehead (1987) showed that the searching strategy of males implies that if whaling reduces the number of groups of females, and not just the mean group size, then males will take longer to travel between groups of females, and females will be less likely to meet a male during their oestrous. Thus a lower population density would tend to produce a lower pregnancy rate, countering the usual density-dependent effects based on food limitation.

Summary – estimation of population parameters

Of the parameters in the current sperm whale model, we are able to estimate four from photo-identification and other non-lethal data. For two of these, mean school size and length at social maturity for males, the estimates are close to those from whaling data (e.g. Best, 1979; IWC, 1982).

However, the percentage of first year calves is lower than expected, and the percentage of mature females per school higher than expected. These are consistent with each other if the mean reproductive rate of Galápagos sperm whales is considerably lower than measured elsewhere. A possible reason for a low mean reproductive rate is the presence of numbers of post-reproductive females and older females with decreased reproductive rates in the schools. There is evidence for post-reproductive females in sperm whales (Best *et al.*, 1984; Marsh and Kasuya, 1986) and it is reasonable that these would be more evident in a population not subject to much recent exploitation, like the eastern North Pacific females which seem to inhabit the Galápagos (Whitehead, Weilgart and Waters, 1990), than in the exploited populations from which previous data were obtained. Killer whales, *Orcinus orca*, off British Columbia and Washington State show a particularly low mean calving rate because of the presence of older females which are not reproducing or are reproducing especially slowly (Olesiuk and Bigg, 1990).

We can reasonably expect to be able to estimate some of the other parameters of the current sperm whale model (the age at first reproduction for females, and the ages at recruitment) by non-lethal techniques within several years if current effort is maintained or increased. Other parameters (natural mortality and the density-dependent exponent) appear less tractable. A model for which some key parameters are unknown is obviously of limited use in predicting yields or recovery rates. However, a good understanding of life history is an essential component in forming management strategies.

POPULATION SIZE

Visual and acoustic censuses

Whitehead and Gordon (1986) suggested three principal techniques by which sperm whale population sizes might be estimated in the absence of catches: visual censuses, acoustic censuses and mark-recapture methods. Visual censuses of sperm whales have been attempted in the past (e.g. Rice, 1977; Laake and Hammond, 1984) but acoustic censuses appear potentially more efficient: they can be carried out at times of poor visibility, sperm whales are generally audible at larger ranges than they are visible, and they vocalise for a greater proportion of the day than they are at the surface (Whitehead and Gordon, 1986). Gordon, Arnbohm and Deimer (1988) are developing acoustic census methodology for sperm whales. Mullins, Whitehead and Weilgart (1988) have presented data on the proportion of time spent vocalising and the proportion of the time at the surface for two single sperm whales off Nova Scotia and Whitehead and Weilgart (in press) have modelled the rates at which sperm whale clicks are heard as a function of behaviour and the number of whales present. These are the type of data needed to calibrate visual and acoustic censuses so that absolute population estimates may be calculated. The efficiency and likely utility of visual and acoustic censuses have been discussed by Whitehead and Gordon (1986).

Mark-recapture: females

Whitehead and Waters (1990) have examined the population size and structure of the female sperm whales off the Galápagos Islands using mark-recapture methods. For these analyses, groups of female sperm whales were used as units. This virtually eliminates some of the problems associated with mark-recapture analysis applied to natural markings (Hammond, 1986): change of marks (it is most unlikely that all or even many individuals in a group will change their marks over any reasonable time period); birth and death (it is probable that groups are born and die much less frequently than individuals – the groups seem to be reasonably stable in composition over periods of years (Whitehead and Waters 1990)); and unequal identifiability (the probability of obtaining sufficient identification photographs to identify a group encountered for a reasonable period in daylight is virtually one). The estimates of group population size can be converted to individual population size, using estimated mean group sizes.

Petersen estimates for the number of groups of female sperm whales off the Galápagos gave larger population sizes when the interval between the sampling units was longer, indicating violations of the assumption that the population was closed. To investigate the problem of emigration of groups from the study area, and especially reimmigration of groups that had previously been in the area but had left it, Whitehead (in press) developed a maximum likelihood mark-recapture technique. There were no previous mark-recapture techniques which allowed reimmigration of individuals that had left the study area. In this technique, maximum-likelihood estimates of population sizes and immigration and reimmigration rates are calculated iteratively on a computer. Likelihood ratio tests are used to examine whether reimmigration is actually occurring, and, if not, whether there is any emigration or mortality.

The technique suggested a population of about 15–22 groups off the Galápagos Islands, with 1–4 groups entering and leaving the area each month (Whitehead and Waters, 1990). The presence of emigration was confirmed, but likelihood ratio tests did not show significant reimmigration. Thus the question of whether a very large population (virtually the North Pacific), or reasonably small local stock (with about 100 groups), was using the Galápagos area remains open (Whitehead and Waters, 1990). Simulation suggests that analysis of data from another long study (carried out in 1989) should allow the situations of virtually no reimmigration and substantial reimmigration to be distinguished. In the latter case, it will also permit the size of the parent stock of female sperm whales visiting the Galápagos area to be estimated.

Techniques like this allow inferences about population size and structure to be made from mark-recapture data which were not collected randomly or systematically from the entire home range of the population. They are therefore particularly important for photo-identification mark-recapture studies of sperm whales, which have large oceanic ranges and substantial populations. The Galápagos example shows that it is possible to obtain useful population estimates for female sperm whales from photo-identification data.

Mark-recapture: males

For the male sperm whale progress has been much slower. No large mature males were individually identified in the Sri Lankan studies (Gordon, 1987a) and only 13 were identified from the Galápagos with none common to both the 1985 and 1987 studies (Whitehead and Waters, 1990). To estimate male sperm whale population sizes we need photo-identification in areas where they are reasonably abundant. This is beginning in the North Atlantic with effort off the Azores, Norway, Nova Scotia and other regions (Arnbom *et al.*, 1988).

What sample sizes do we need to expect results? When the same number of male sperm whales are photographed in each of two studies, Fig. 1 gives the relationship between the population size, the size of each of the two samples and the accuracy of a Petersen estimate based on the reidentifications between them.

So if there are about 5,000 males in the population, perhaps very roughly what might be expected for the North Atlantic (IWC, 1982), about 120 males need to be photographed in each study for a rough estimate, and about 600 for a precise one. If more than two sampling periods are carried out, the samples can be smaller. Progress is rather slower with the males than for the females which have the convenience of travelling in virtually closed groups. For the males, we would also have to consider problems such as unidentifiable animals, changing fluke patterns, mortality and recruitment.

CONCLUSION

It is eight years since detailed research on living sperm whales using small sailing vessels was begun off Sri Lanka. During this period there have been approximately 12 dedicated studies lasting two months or more in various parts of the world. The data from these studies have allowed advances in our understanding of the population biology of sperm whales: the assumption of a harem breeding system was shown to be incorrect; a factor not previously incorporated in the sperm whale model, the

return rate of males to the breeding grounds, was identified as a potential source of reduced breeding success; some population parameters have been estimated successfully, and in two cases (the proportion of females in a breeding school and the calving rate) found to be substantially different from previous estimates; and off the Galápagos Islands we are beginning to obtain useful estimates of population size and stock structure for female sperm whales.

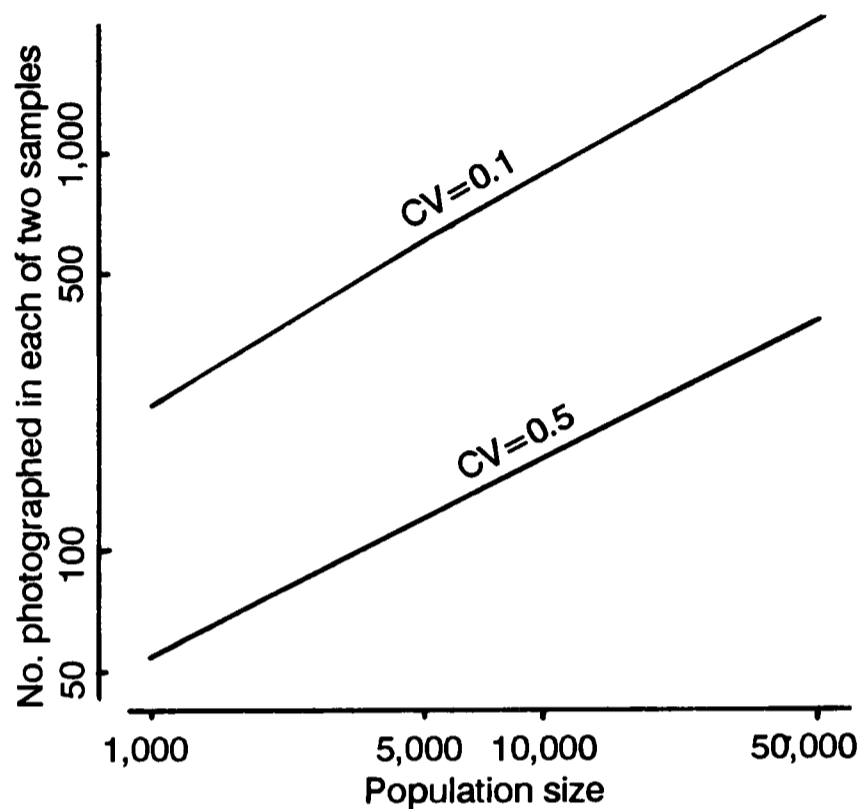

Fig. 1. The relationship between population size, the number of individuals identified in each of two samples and the coefficient of variation of a Petersen population estimate based upon the reidentification rate.

However, we are far from an accurate sperm whale model with accurate parameters; the new non-lethal research has highlighted deficiencies in the current model rather than improving it. Other reports in this volume show that with long-term studies of individually identifiable animals we can examine the population biology of cetacean species in considerable detail. The same will be true for sperm whales if sufficient long-term studies can be continued, although, because of the sizes of their populations, their geographic ranges, and slow maturation rates, progress will tend to be slower.

If we are really interested in the response of sperm whale populations to changes in exploitation, the best strategy in the medium term is probably to assess population sizes at regular intervals using acoustic or visual censuses, or mark-recapture analyses based on photo-identifications.

ACKNOWLEDGEMENTS

I thank all those who have taken part in our sperm whale research but especially Tom Arnbom, Jonathan Gordon, Susan Waters and Linda Weilgart. Major sponsors of our research have been Mrs Mary Clark, the Green Island Foundation, the International Whaling Commission, the Natural Sciences and Engineering Research Council of Canada and the World Wildlife Fund. I thank Susan Waters and Linda Weilgart (Biology Department, Dalhousie University, Halifax, Nova Scotia, Canada B3H 4J1) and two anonymous reviewers for useful comments on the manuscript.

REFERENCES

- Adler-Fenchel, H.S. 1980. Acoustically derived estimate of the size distribution from a sample of sperm whales (*Physeter catodon*) in the western North Atlantic. *Can. J. Fish. Aquat. Sci.* 37: 2,358-61.
- Arnbom, T. 1987. Individual identification of sperm whales. *Rep. int. Whal. Commn* 37: 201-4.
- Arnbom, T., Gordon, J. and Waters, S. 1988. Occurrence of natural marks on sperm whales, *Physeter macrocephalus*, from the Indian, North Atlantic, and Pacific Oceans. Paper SC/A88/ID19 presented to the IWC Workshop on Individual Recognition and the Estimation of Cetacean Population Parameters, La Jolla, 1988 (unpublished).
- Arnbom, T. and Whitehead, H. 1989. Observations on the composition and behaviour of groups of female sperm whales near the Galápagos Islands. *Can. J. Zool.* 67: 1-7.
- Best, P.B. 1979. Social organisation in sperm whales. pp. 227-89. In: H.E. Winn and B.L. Olla (eds.) *Behaviour of Marine Animals, Vol. 3*. Plenum Press, New York.
- Best, P.B., Canham, P.A.S. and Macleod, N. 1984. Patterns of reproduction in sperm whales, *Physeter macrocephalus*. *Rep. int. Whal. Commn* (special issue 6): 51-79.
- Buckland, S. 1990. Estimation of survival rates from natural marking data. Paper SC/A88/ID5 (published in this volume).
- Clapham, P.J. and Mayo, C.A. 1987a. The attainment of sexual maturity in two female humpback whales. *Mar. Mamm. Sci.* 3:279-83.
- Clapham, P.J. and Mayo, C.A. 1987b. Reproduction and recruitment of individually-identified humpback whales, *Megaptera novaeangliae*, observed in Massachusetts Bay, 1979-1985. *Can. J. Zool.* 65: 2,853-63.
- Cooke, J.G., de la Mare, W.K. and Beddington, J.R. 1983. Some aspects of the reliability of the length data for the western North Pacific stock of sperm whales. *Rep. int. Whal. Commn* 39:265-7.
- Glockner-Ferrari, D.A. and Ferrari, M. 1990. Reproduction in the humpback whale (*Megaptera novaeangliae*) in Hawaiian waters, 1975-1988: the life history, reproductive rates and behavior of known individuals identified through surface and underwater photography. Paper SC/A88/ID30 (published in this volume).
- Gordon, J.C.D. 1990. A method for measuring the length of whales at sea. *Rep. int. Whal. Commn* 40: 581-8.
- Gordon, J.C.D. 1987a. Sperm whale groups and social behaviour observed off Sri Lanka. *Rep. int. Whal. Commn* 37: 205-17.
- Gordon, J.C.D. 1987b. The behaviour and ecology of sperm whales off Sri Lanka. PhD Thesis, University of Cambridge, Cambridge, England.
- Gordon, J.C.D., Arnbom, T. and Deimer, P. 1988. Cetacean research being conducted in the Azores by the International Fund for Animal Welfare. Paper SC/40/O 39 presented to the IWC Scientific Committee, May 1988. (Unpublished).
- Hammond, P.S. 1986. Estimating the size of naturally marked whale populations using capture-recapture techniques. *Rep. int. Whal. Commn* (special issue 8):253-82.
- Hoelzel, A.R. and Dover, G.A. 1989. Molecular techniques for examining genetic variation and stock identity in cetacean species. *Rep. int. Whal. Commn.* (special issue 11): 81-120.
- International Whaling Commission. 1981. Report of the sub-committee on sperm whales. *Rep. int. Whal. Commn* 31: 78-102.
- International Whaling Commission. 1982. Report of the sub-committee on sperm whales. *Rep. int. Whal. Commn* 32: 68-73.
- International Whaling Commission. 1983. Report of the sub-committee on sperm whales. *Rep. int. Whal. Commn* 33: 74-81.
- Kasuya, T. and Ohsumi, S. 1966. A secondary sexual character of the sperm whale. *Sci. Rep. Whales. Res. Inst., Tokyo* 20: 89-94.
- Laake, J.L. and Hammond, P.S. 1984. Estimates of sperm whale density in the eastern tropical Pacific, 1974-1982. *Rep. int. Whal. Commn* 34: 255-8.
- Marsh, H. and Kasuya, T. 1986. Evidence for reproductive senescence in female cetaceans. *Rep. int. Whal. Commn* (special issue 8): 57-74.
- May, R.M. and Beddington, J.R. 1980. The effects of adult sex ratio and density on the fecundity of sperm whales. *Rep. int. Whal. Commn* (special issue 2): 213-7.
- Mizroch, S.A. and York, A.E. 1985. Have pregnancy rates of Southern Hemisphere fin whales, *Balaenoptera physalus*, increased? *Rep. int. Whal. Commn* (special issue 6) : 401-10.
- Mullins, J., Whitehead, H. and Weilgart, L.S. 1988. Behaviour and vocalisations of two single sperm whales, *Physeter macrocephalus*, off Nova Scotia. *Can. J. Fish. Aquat. Sci.*: 45(10): 1736-43.
- Ohsumi, S. 1977. Age-length key of the male sperm whale in the North Pacific and comparison of growth curves. *Rep. int. Whal. Commn* 27: 295-300.
- Olesiuk, P. and Bigg, M. 1990. Life history and population dynamics of resident killer whales in coastal waters off British Columbia and Washington State. Paper SC/A88/ID3 (published in this volume).
- Payne, R., Rowntree, V., Perkins, J.S., Cooke, J.G. and Lankester, K. 1990. Population size, trends and reproductive parameters of right whales (*Eubalaena australis*) off Peninsula Valdes, Argentina. Paper SC/A88/ID1 (published in this volume).
- Ralls, K., Brownell, R.L. Jr and Ballou, J. 1980. Differential mortality by age and sex in mammals, with specific reference to the sperm whale. *Rep. int. Whal. Commn* (special issue 2): 233-43.
- Rice, D.W. 1977. Sperm whales in the equatorial eastern Pacific: population size and social organisation. *Rep. int. Whal. Commn* 27: 333-6.
- Waters, S. and Whitehead, H. 1990. Population and growth parameters of Galápagos sperm whales estimated from length distributions. *Rep. int. Whal. Commn*: 40: 225-35.
- Whitehead, H. 1987. Social organisation of sperm whales off the Galápagos: implications for management and conservation. *Rep. int. Whal. Commn* 37: 195-9.
- Whitehead, H. In press. Mark-recapture estimates with emigration and re-immigration. *Biometrics*.
- Whitehead, H. and Arnbom, T. 1987. Social organisation of sperm whales off the Galápagos Islands, February-April 1985. *Can. J. Zool.* 65(4): 913-9.
- Whitehead, H. and Gordon, J. 1986. Methods of obtaining data for assessing and modelling sperm whale populations which do not depend on catches. *Rep. int. Whal. Commn* (special issue 8): 149-66.
- Whitehead, H. and Weilgart, L.S. In press. Click rates from sperm whales. *J. Acoust. Soc. Am.*
- Whitehead, H., Papastavrou, V. and Smith, S.C. 1989. Feeding success of sperm whales and sea-surface temperature off the Galápagos Islands. *Mar. Ecol. Prog. Ser.* 53: 201-3.
- Whitehead, H. and Payne, R. 1981. New techniques for measuring whales from the air. Final report to US Marine Mammal Commission. MMC-76/22. NTIS Publ. PB81-161143. 36pp.
- Whitehead, H. and Waters, S. 1990. Social organisation and population structure of sperm whales off the Galápagos Islands, Ecuador (1985 and 1987). Paper SC/A88/ID45 (published in this volume).
- Whitehead, H., Weilgart, L.S. and Waters, S. 1989. Seasonality of sperm whales off the Galápagos Islands, Ecuador. *Rep. int. Whal. Commn* 39:207-10.

Social Organization and Genealogy of Resident Killer Whales (*Orcinus orca*) in the Coastal Waters of British Columbia and Washington State

M. A. Bigg, P. F. Olesiuk, G. M. Ellis,

*Department of Fisheries and Oceans, Pacific Biological Station,
Nanaimo, British Columbia, Canada V9R 5K6*

J. K. B. Ford

Vancouver Public Aquarium, P.O. Box 3232, Vancouver, British Columbia, Canada, V6B 3X8

and K. C. Balcomb III

Center for Whale Research, Friday Harbor, Washington 98250

ABSTRACT

The social organization and genealogy of resident killer whales in the coastal waters of British Columbia and Washington State are examined based on field observations and analyses of photographs of recognizable individuals collected during 1973–87. All individuals were identified in two communities, with 261 animals alive in 1987. The membership of social groups is determined by observing which individuals travel most frequently together and by examining the relative strength of bonds among individuals within groups. The strength of bonds is established from direct observations of the proximity of individuals to one another and from an analysis of the association of individuals in photographic sequences. The social organization is classified into communities, pods, subpods and intra-pod (matrilineal) groups. A community comprises individuals that share a common range and associate with one another; a pod is a group of individuals within a community that travels together the majority of the time; a subpod is a group of individuals that temporarily fragments from its pod to travel separately; an intra-pod group consists of a cohesive group of individuals within a subpod that always travels in close proximity. Communities contain 3–16 (mean=9.5) pods; pods contain 1–3 (mean=1.7) subpods, subpods contain 1–11 (mean=1.9) intra-pod groups and intra-pod groups contain 2–9 (mean=3.6) individuals. The membership at each group level was stable during the study, except for births and deaths. No dispersal of individuals or groups was observed.

Genealogical trees within pods are constructed from known genealogies and from inferences about genealogy based on the strength and continuity of bonds among pod members. The genealogical trees indicate that intra-pod groups are matrilineal. A matrilineal group typically comprises of 2–3 generations (range 1–4; mean=2.3) and a generalized matrilineal group consists of a grandmother, her adult son, her adult daughter and the offspring of her daughter. Matrilineal groups are the basic unit of social organization. New matrilineal groups appear to form by splitting along maternal lines. Subpods and pods appear to be comprised of related matrilineal groups and probably form through the gradual splitting of their natal subpods or pods along matrilineal group lines. Pod-specific dialects suggest that related pods eventually associate randomly. Pods are grouped into four acoustic (but not social) clans. Pods within each clan are likely to have a distant common ancestor.

The lack of dispersal of the resident form of killer whale from their natal groups appears to be unique among mammalian social systems. However, dispersal appears to occur in the transient form, which also differs in physical appearance, distribution and behaviour. The two forms may have evolved after adopting different foraging strategies. This species has the potential to have developed many local races over its cosmopolitan range, with each race having unique social and behavioural characteristics.

1. INTRODUCTION

Numerous studies on the biology of killer whales (*Orcinus orca*) in the coastal waters of British Columbia and Washington State have been facilitated by the fact that all individuals can be recognized from unique natural markings. These studies have provided information on abundance, movements, behaviour, feeding habits, vocalizations, social organization, life history and population dynamics (Balcomb, Boran and Heimlich, 1982; Bigg, 1982; Ford and Fisher, 1982; 1983; Balcomb and Bigg, 1986; Haenel, 1986; Heimlich-Boran, J.R., 1986; 1988; Heimlich-Boran, S.L., 1986; Jacobsen, 1986; Bigg, Ellis, Ford and Balcomb, 1987; Olesiuk and Bigg, 1990).

An important finding of these studies regarding social organization was that two forms of killer whale, termed 'resident' and 'transient', inhabit this region. The resident form comprises a northern and southern community, whereas the transient form is a single community that is sympatric with but does not mix with the two resident

communities. The resident form is the most abundant comprising about 75% of all individuals identified. Resident whales travel in long-term groups known as pods. It has also been noted that there are groupings within pods (Bigg, 1982).

In recent years, we have focused our studies on the social organization and genealogies of pods within the two communities of resident killer whales. Bigg *et al.* (1987) summarized some of these findings in a popular account on the biology of killer whales. In this paper we examine social organization and genealogies using field observations and photographs collected during 1973–87. The identity and individual membership of each pod and the social structure within pods was determined by observing which individuals travelled together most often and by examining the relative strength of bonds among individuals within groups. The relative strength of bonds was determined from: (1) direct observation of the proximity of individuals to one another as seen during field observations and in photographs; and (2) an index of the degree of association among individuals in photographic sequences. The individuals within each

pod are described in a registry that listed their name code, group affiliations and, where known, their sex, year of birth, year of death and their mother's identity.

Maternal genealogical trees were constructed based on known mother-offspring genealogies and genealogies inferred from the strength and continuity of bonds among individuals. The likely genealogies among pods were examined based on the relative degree of association of pods and on pod-specific dialects. The significance of genealogy in the social organization of the resident communities is discussed and the social organization of the resident and transient forms compared.

The results presented in this study describe the social organization and likely genealogies of all individuals within the two communities. The methods utilized may be applicable to other long-term studies of killer whales and to other species. This report provides a framework for additional killer whale studies. For example, the genealogies given here are used in an analysis of the life history and population dynamics of resident killer whales (Olesiuk and Bigg, 1990) and the data can be used in on-going sociobiological studies.

2. DATA COLLECTION AND ANALYSIS

2.1 Study area and duration

Studies were conducted in the inshore waters of British Columbia and Washington State. Whales were encountered most frequently in Johnstone Strait and Haro Strait (Fig. 1), two core areas where the northern and southern communities, respectively, congregate during summer months. Whales were also observed at many other sites off eastern Vancouver Island and in Puget Sound, but only occasionally north of Vancouver Island and off the west coasts of Vancouver Island and Washington State. Most encounters were within 10km of shore, but some were as far as 30km offshore.

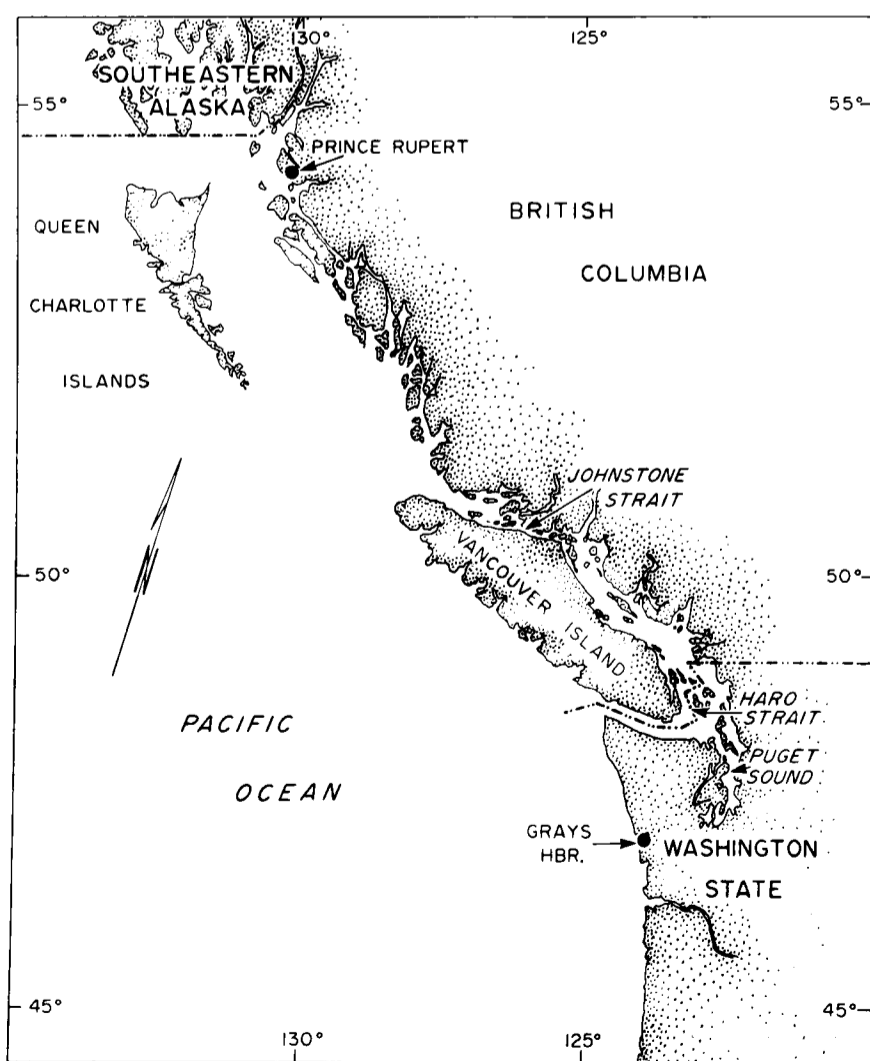

Fig. 1. Geographical names in British Columbia and Washington State referred to in the text.

The study began in Johnstone Strait in 1973 and was expanded to include most areas off eastern and southern Vancouver Island in 1974, Puget Sound in 1976 and then to other coastal areas of British Columbia and Washington State. Whales were encountered in all months, although mainly during July to September (Fig. 2a). Data were collected annually, for the northern community from 1973 and for the southern community from 1974 (Fig. 2b). The analyses here include data obtained up to the end of 1987. The unusually large number of encounters in 1986 was provided mainly by other researchers who kept almost daily records of the identity of pods seen in Johnstone Strait during the summer months.

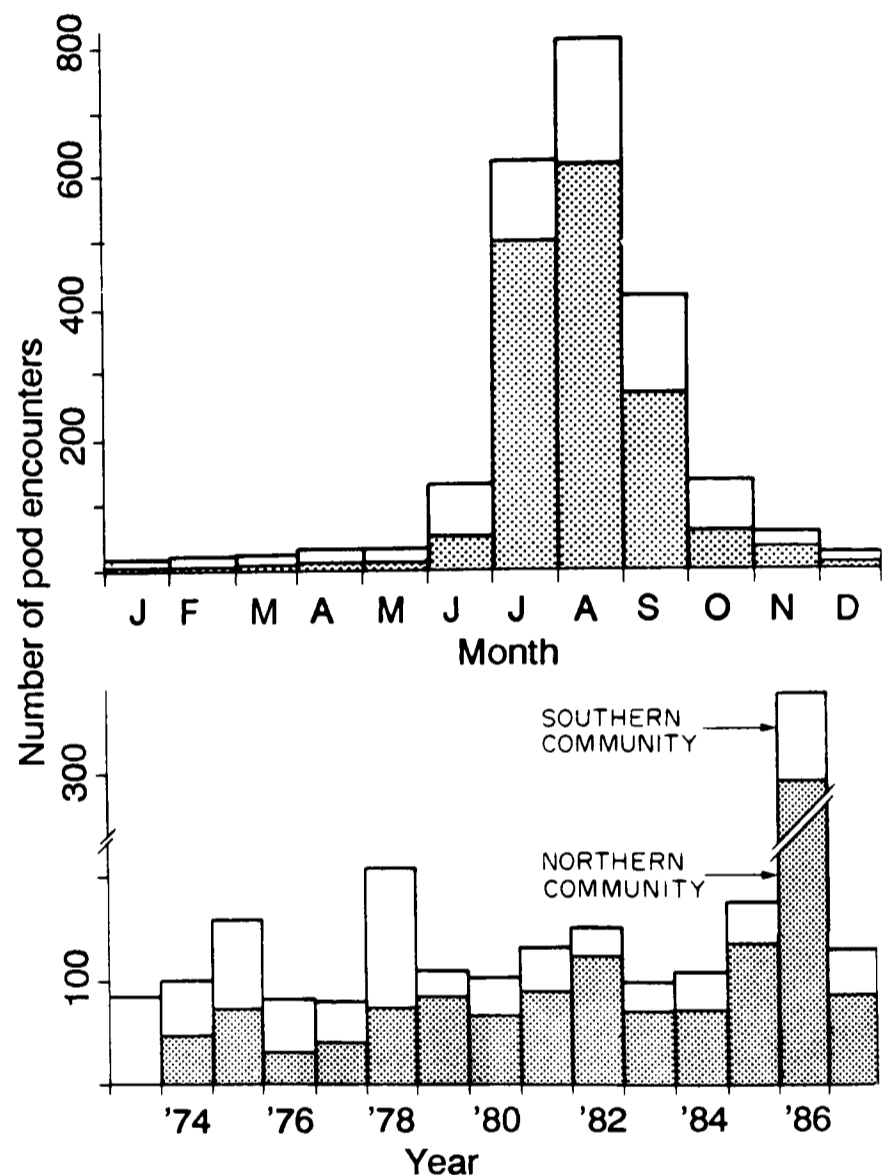

Fig. 2. Number of pod encounters with pods belonging to the northern and southern communities during 1973-87: (a) by month and (b) by year. The number of pod encounters represents the product of the total number of encounters and the number of pods present during each encounter.

The start of the study for each pod was defined as the first year in which all members of the pod were identified: 1973 for pods A01, A04, A05, B01, C01 and D01; 1974 for pods J01, K01 and L01; 1975 for pods G01, G12, H01, I01, I02, I11, I18, I35 and R01; and 1979 for pod W01. In some cases, data collected for pod members prior to these years were used because they provided information on ages and reproductive histories.

2.2 Individual identification and nomenclature

Individuals were identified from the unique appearance of their dorsal fin, saddle patch and back when viewed laterally, usually from the left side. The distinctive features included the relative size, shape and outline of the dorsal fin, saddle patch and back, as well as scratches, nicks, gouges and blemishes. Most individuals were recognizable

by eye, but some required a good photograph for positive identification. The distinctive features of individuals in the study region were shown in three field guides (Sugarman, 1984; Bigg *et al.*, 1987; Osborne, Calambokidis and Dorsey, 1988).

Each whale was assigned an alpha-numeric code. A single letter designated its pod and a two-digit number its identity within the pod. Pods were named after one of their members, generally the most distinctive individual. Several pods shared the same letter designation, such as pods A01, A04 and A05. The members of these pods also shared the same letter designation. For example, pod A01 contained individuals A01, A06, A33 and others, pod A04 contained individuals A04, A11, A52 and so on.

2.3 Field procedures

Whales were encountered mainly by waiting in core areas, such as Johnstone Strait and Haro Strait. They were located in other areas with the help of a network of volunteers who reported sightings by telephone. Observations were made from 5–7m power boats. During an encounter, each individual was usually photographed several times from a distance of 15–30m. We used a 35mm SLR camera equipped with an auto-film winder, a 300mm telephoto lens, a shoulder brace (Bigg, Ellis and Balcomb, 1986) and black and white film, either *Kodak TriX Pan* or *Ilford HP5* (preferred) exposed and processed at ISO 1600. Members of the southern community were identified in a total of 22,768 photographs and members of the northern community in 21,034 photographs. Throughout the study, each photographic frame was examined numerous times with a dissecting microscope to ensure that all individuals had been correctly identified (Bigg *et al.*, 1986).

During an encounter, we recorded the total number of individuals present, the identity of individuals that could be recognized by eye, individuals that were missing from their pod, the relative distances separating each individual and the body size of individuals relative to that of fully grown females and males. The identity of known mother-offspring pairs was also noted. A calf was considered to be the known offspring of an adult female if the calf was born during the study and travelled in very close contact with a particular adult female. Most calves were assigned to mothers when they were 0.5 years (85%) of age, but some were assigned to mothers at 1.5 (8%) or 2.5–5.5 years (7%). Underwater vocalizations were often recorded with a hydrophone to establish which pods were present based on pod-specific dialects (Ford and Fisher, 1982; 1983). Other researchers (see Acknowledgments) studying killer whales in the area also contributed photographs and similar observations.

2.4 Life history parameters

It is important to know the sex and age of individuals in order to establish genealogies. Several life history parameters described in Olesiuk and Bigg (1990) are summarized here to indicate how individuals were sexed and aged. Females attain the lower range of adult-size at about 10 years of age and typically give birth to their first viable calf (a calf that survives to 0.5 years of age) at 15 years of age. Females are typically reproductively senescent by age 40 years, although longevity sometimes extends to 80–90 years. Males grow more rapidly and by about 8 years approach the lower size range of adult females. Mature males can be distinguished from juveniles and adult females by the height to width ratio (HWR) of

their dorsal fin, which typically exceeds 1.4 by 15 years of age. The dorsal fin of males continues to grow to an asymptotic HWR of 1.6–1.8 by about 21 years, although males sometimes live up to 50–60 years.

The sex, age and other data on each individual are listed in Appendix Tables A and B. The year that an individual was first seen usually coincided with the year in which all members of its pod were identified. However, some individuals were identified in photographs taken by the public, naturalists and aquaria personnel as early as 1965. The year of death was considered to have been the year it disappeared from its pod. A range of years was given when several years lapsed between the time that the whale was last seen and the next complete census of its pod. The interval between the first and last year on arrival was seen provides a general indication of the amount of data for the individual.

2.4.1 Sex determination

The sex of most juveniles could not be determined except in cases where the penis or the unique pigmentation pattern of the genital region was observed (Bigg *et al.*, 1987). Individuals were classified as physically mature females when they attained the lower size range of an adult female and there was no apparent body growth or increase in HWR over a period of at least 4–5 years. Physically mature females that gave birth during the study or were accompanied by offspring were classified as sexually mature. Individuals whose dorsal fin attained an HWR of at least 1.4 were classified as sexually mature males. Males were considered to be physically mature once their dorsal fin reached its asymptotic HWR of 1.6–1.8.

2.4.2 Relative ages

The year of birth for most calves born during the study was known because adult females were usually encountered each year and the presence of new calves noted. In a few cases, the calves of females not encountered every year may not have been born in the year in which they were first encountered. In such cases, the year of birth was estimated based on the body size of the calf when first seen compared to that of known-aged juveniles. Juveniles grow rapidly during the first few years and can be aged by size up to about 3 years of age. A range in birth years was noted when a calf was judged to have been born in either of 2 years. Small juveniles estimated to have been born 1–3 years prior to the start of the study for their pod (Section 2.1) were similarly aged based on their size when first seen.

The year of birth of juveniles aged >3 years at the start of the study was estimated by subtracting the mean age of maturity (15 years for both sexes) from the year they matured. Females were considered to have matured in the year they gave birth to their first viable calf and males in the year in which their dorsal fin attained an HWR of 1.4. Seven juveniles aged >3 years (A16, A24, K40, B04, B20, R04, W05) at the start of the study were aged on the basis of their relative body size when first seen because the above ageing techniques were not applicable.

The year of birth of males that were sexually but not physically mature at the start of the study was estimated by subtracting the mean age of physical maturity (21 years) from the year their dorsal fin attained its asymptotic HWR. The year of birth of males that were physically mature at the start of the study could not be determined. However, we calculated their minimum ages by assuming that they had attained physical maturity in the year they were first

seen. Photographs of 11 physically mature males taken prior to the start of the study provided improved estimates of minimum ages.

The year of birth of females that were mature at the start of the study was established in conjunction with the construction of genealogical trees (Section 4.1). We assumed that a female's oldest assigned offspring was her first viable calf. The year of birth of the mother was estimated by subtracting 15 years from the estimated year of birth of her oldest offspring. These represented minimum ages because the oldest progeny may have died or been cropped (Section 3.2) prior to the start of the study. The reproductive status of mature females provided another indication of their relative age. Females that had not given birth for a decade or more were likely to be post-reproductive (Olesiuk and Bigg, 1990) and older than reproductive females. Given the potential inaccuracies in these age estimates, the ages were used conservatively in the construction of genealogical trees.

Olesiuk and Bigg (1990) derived ages for mature females using probabilistic correction factors based on natural mortality rates and other life history parameters. These age estimates are considered to be the most accurate available and are thus included in Appendix Tables A and B. However, they were not considered in the construction of the genealogical trees because they were based on the genealogies established in this study. Bigg *et al.* (1987) previously estimated the actual ages for some old mature females by assuming that their offspring were born during the mid-portion of their reproductive lives. These ages differed only slightly from those of Olesiuk and Bigg (1990).

2.5 Social groups and relative bond strengths

The membership of social groups and the relative strength of bonds among individuals within the groups were determined using a combination of direct observations and an association analysis. Both methods were used because neither alone was suitable in all cases. Direct observations were particularly useful for establishing the membership of social groups and the strength of bonds of individuals for which there were few photographs. However, association analysis was more useful for quantifying the strength of bonds and for establishing subtle bonds that could not be detected by direct observation.

2.5.1 Direct observations

We determined the membership of social groups by observing which individuals travelled most frequently together. These social groups were evident from observations in the field and from an examination of photographs with more than one individual present. The relative strength of bonds among group members was also recorded from observations in the field and from an examination of photographs. Individuals that consistently surfaced within 1–2 body lengths (5–10m) of each other were considered to be the most strongly bonded, whereas individuals within a social group that rarely surfaced in the vicinity of one another were considered to be the most weakly bonded.

One of our main research priorities during 1978–87 was to establish the membership of groups within pods and the relative strength of bonds among pod members. This was a cumulative process. The existence of pods and smaller groups became apparent during the 1970s (Bigg, 1982) and the identity and membership of almost all of the smaller

groups had been established by the early 1980s. The group memberships and relative strengths of bonds among group members were also compared with those determined from earlier versions of the association analysis (mainly early 1980s). If a new group membership or bond strength indicated by the earlier association analysis was confirmed by direct observation, we considered the new finding to have been established by direct observation. The comparisons made later in this report between direct observations and association analyses included much more data than were available for the earlier versions of association analysis. Only minor revisions of group memberships and bond strengths were necessary after the early 1980s.

The membership and stability of the groups have been frequently re-assessed in recent years. Photographs that contained more than one individual were particularly important for determining group membership and the relative strength of bonds among individuals early in the study before extensive field observations had been made. Direct observations were considered the most reliable source of information on associations, although these observations were continuous and not suited to a quantitative analysis.

2.5.2 Association analysis

Photographic sequences also provided information on the membership of social groups and relative bond strengths. Individuals that travelled in the same groups tended to occur in the same or adjacent photographs more often than individuals in different groups. Group members that travelled in close proximity tended to occur in such photographs more often than those that travelled distantly from one another. The photographic data were prepared for analysis by sorting frames into the sequence in which they were taken. The identity of all individuals in each frame or, optionally, in the ± 1 or ± 2 adjacent frames, was tallied for each encounter. Photographic frames or sequences that contained less than two individuals were deleted because they provided no information on association. Data from the remaining frames were accumulated in 2×2 contingency tables for each pair of whales for all years in which both individuals were photographed:

		First Individual		
		present	absent	total
Second Individual	present	a	b	a + b
	absent	c	d	c + d
	total	a + c	b + d	n

where $a+c$ and $a+b$ denote the total number of occurrences of the first and second individuals respectively, a the number of joint occurrences and d the total number of frames in which neither whale occurred in years in which both were photographed.

The degree of association between individuals was measured using Cole's (C_7 in Cole, 1949) association index (CAI):

$$CAI = \frac{ad - bc}{(a + b)(b + d)} \text{ for } ad \geq bc$$

$$CAI = \frac{ad - bc}{(a + b)(a + c)} \text{ for } bc > ad \text{ and } d \geq a$$

$$CAI = \frac{ad - bc}{(b + d)(c + d)} \text{ for } bc > ad \text{ and } a > d$$

which, expressed as a percent, ranged from -100 to +100 with a value of 0 indicating that individuals were randomly distributed in the photographs.

The CAI differs from most association indices in that it measures complete association (see Kendall and Stuart, 1967). Values of +100 occur only when the joint number of occurrences equals the number of occurrences of the less frequently identified individual (i.e. a equals the lesser of $a+b$ and $a+c$). In contrast, most other indices measure absolute association and give values of +100 only when both individuals always occur together (i.e. a equals $a+b$ and $a+c$).

An index of complete association was more appropriate because not all individuals were equally identifiable. Thus, an index of absolute association would have been biased in that individuals identified in many photographs would have tended to have higher associations than indistinctive individuals identified in few photographs. For example, an index of absolute association would tend to underestimate the degree of association between calves and their mothers, which always travelled together, merely because the calves were usually not well marked and had been identified in fewer photographs than the mother. In contrast, the CAI index would accurately indicate the high degree of association between calves and their mothers because the index is scaled according to the number of photographs of the calves.

CAI values were calculated for all pairs of individuals within each community for the periods 1973-76, 1977-80, 1981-84, 1985-87 and for all years combined. Because of the volume of these tabulations, only CAI values calculated for ± 1 frame and all years combined are presented. Nevertheless, CAI values in the other year groups were also used to examine bond strengths, especially when discrepancies existed between the association analysis and direct observations.

The membership of social groupings was identified from dendrograms constructed using an agglomerative average single-link algorithm (Johnson, 1967). In this procedure, the CAI values among all possible pairs of individuals were compared and the pair with the highest CAI linked. Next, the pair of unlinked individuals with the highest CAI were linked, or an unlinked individual with a higher mean CAI value with previously linked individuals was linked to that pair, and so forth until the mean CAI dropped to +15%.

The degree of association between the groups linked at $\geq 15\%$ CAI was measured using the point correlation coefficient (PCC):

$$PCC = \frac{ad - bc}{\sqrt{[(a+b)(a+c)(b+d)(c+d)]}} \text{ (Poole, 1974)}$$

where a represents the number of photographs containing one or more members of both groups, b and c the number containing members of only one of the groups, and d the number containing no members of either group. Expressed as a percent, the PCC index also ranged from -100 to +100 with 0 indicating random association.

The PCC measures absolute association. There were two reasons for switching from an index of complete association at the individual level to an index of absolute association at the group level. First, the individuals linked at $\geq 15\%$ CAI value represented intra-pod groups (Section 3.4) that always travelled together, whereas the intra-pod groups sometimes travelled separately from one another. Second, individuals differed more in their identifiability than did the groups. Thus, an individual within a group that

was photographed more often than another individual in the same group indicated that it was more identifiable and thus an index of complete association was preferable. On the other hand, a group that was photographed more often than another group indicated that it was travelling independently of the other and thus an index of absolute association was preferable.

One important property of the CAI was that it gave equal weighting to all joint occurrences of whales in photographs. However, whales in a frame were not necessarily equally associated. In a frame containing three individuals, two may have been in close proximity to one another with a third off in the distance. CAI would underestimate the degree of association between the two close individuals and overestimate their degree of association with the third distant individual. Thus, CAI tended to dampen the differences in the strength of bonds among individuals. The potential bias was most prevalent early in the study because a panoramic photographic style was occasionally used. Consequently, the CAI values of individuals that died early in the study tended to be higher and not directly comparable to individuals present throughout or born late in the study. This problem was circumvented by comparing the CAI values for these individuals for the period 1973-76 or by determining bond strengths from direct observations.

3. SOCIAL ORGANIZATION

We classified social organization into a series of progressively smaller groups referred to as communities, pods, subpods and intra-pod groups. Before defining and characterizing each level of organization, some general comments can be made about the behaviour and composition of these groups. Except for births and deaths, we observed no seasonal or long-term change in the membership within any level of social organization. In addition, no instances of immigration or emigration were observed at any level. Groups at each level were composed of individuals of mixed age and sex (Appendix Table A-B). It should be noted that the size of groups in tables and figures (e.g. Figs 4-5, Table 1, Appendix Tables A-B and Appendix Figs A-T) represent the cumulative memberships over all years of the study. In reality, groups tended to be smaller in any given year because some members died or were born during the study. However, the average sizes given in the text refer to the mean size for each year. The social organization is summarized in Table 3.

3.1 Communities

A community was defined as an assemblage of individuals that resided in the same area and periodically associated with one another. The resident whales in the area comprised two communities termed the southern community and the northern community. Individuals within one community did not associate with those in the other and only rarely entered the range of the other. Additional encounters have now refined the geographic ranges of the two communities (Fig. 3) since they were first described (Bigg, 1982). The range of the southern community extends from slightly south of the mid-latitudes of eastern and western Vancouver Island, around southern Vancouver Island, into Puget Sound and south to Grays Harbor on the west coast of Washington State. The range of the northern community extends from the northern

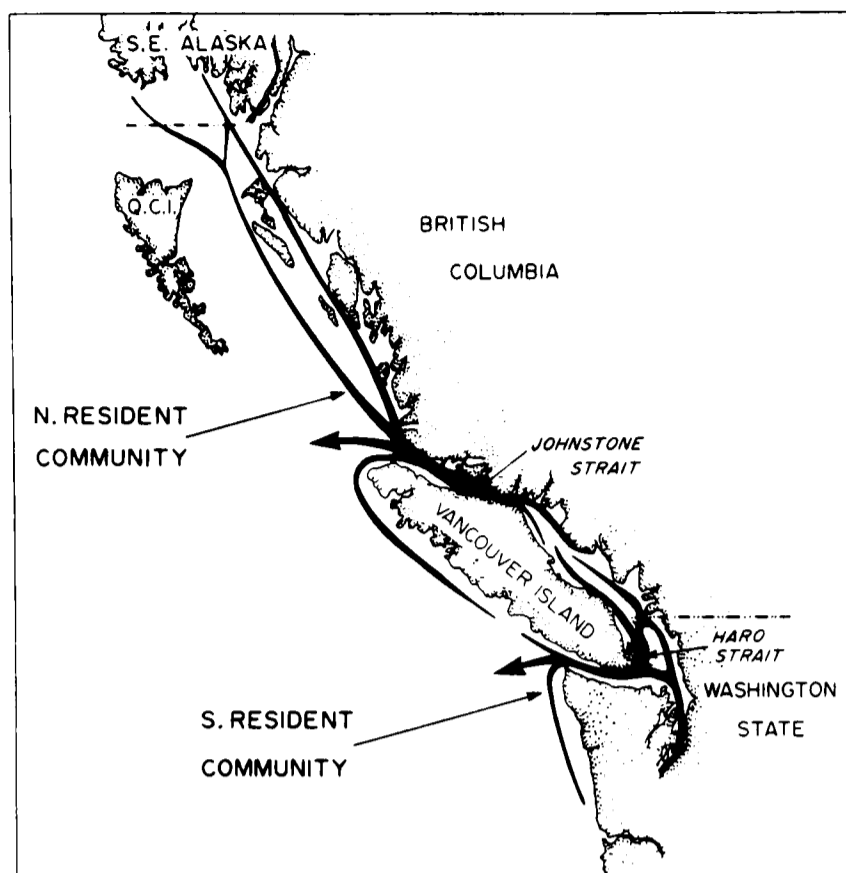

Fig. 3. Geographic ranges of the southern and northern resident communities.

border of the southern community around northern Vancouver Island, along the mainland coast of British Columbia and into southern Southeast Alaska. The community has not been observed off the Queen Charlotte Islands which suggests that it rarely, if ever, ventures there.

Whales in both communities undertake local seasonal movements, but not extensive migrations; they have been observed in the study area in all months of the year (Fig. 2a). However, they were observed most often during summer when they gathered in narrow coastal channels to feed on salmon. They apparently reside mainly offshore during winter-spring.

The southern community comprised 112 identified individuals and the northern community 215 individuals (Table 1). The individuals identified in each community represented virtually all that survived to 0.5 years of age. Olesiuk and Bigg (1990) estimated that only about one (1.2) viable calf would have died not having been identified.

One individual (J24) in the southern community and five (A16, A17, A18, C11, C15) in the northern community were photographed prior to the study, but were not present at the start. All were removed in the live-capture fishery, except for C15 which apparently died before the study began. These individuals were included in the analyses because they provided information on the ages and reproductive histories of their mothers, which were identified from early photographs and were still alive at the start of the study.

3.2 Pods

A pod was defined as the largest cohesive group of individuals within a community that travelled together for the majority of time (i.e. the largest group that travelled together for at least 50% of the time, or conversely the largest group that fragmented less than 50% of the time). The membership of pods was established over many years by observing which individuals most often travelled together. Memberships were supported by pod-specific

Table 1

Identification codes for the 19 pods and 329 individuals identified in the southern and northern communities during 1973-87. Six additional individuals that were cropped for aquaria or had died prior to the start of the study, but whose mothers were alive during the study, are shown in italics.

Southern Community

J01:

J01, J02, J03, J04, J05, J06, J07, J08, J09, J10, J11, J12, J13, J14, J15, J16, J17, J18, J19, J20, J21, J22, J23, *J24*;

K01:

K01, K02, K03, K04, K05, K07, K08, K11, K12, K13, K14, K15, K16, K17, K18, K19, K20, K21, K22, K30, K40, K46;

L01:

L01, L02, L03, L04, L05, L06, L07, L08, L09, L10, L11, L12, L13, L14, L15, L16, L20, L21, L22, L23, L25, L26, L27, L28, L32, L33, L35, L36, L37, L38, L39, L41, L42, L43, L44, L45, L47, L48, L49, L50, L51, L52, L53, L54, L55, L56, L57, L58, L59, L60, L61, L62, L63, L64, L65, L66, L67, L68, L69, L71, L72, L73, L74, L75, L76, L77;

Unknown: B20

Northern Community

A01:

A01, A02, A03, A06, A12, A20, A30, A31, A32, A33, A34, A36, A37, A38, A39, A40, A44, A46, A50;

A04:

A04, A10, A11, A13, A19, A24, A35, A41, A45, A47, A48, A49, A52;

A05:

A05, A07, A08, A09, A14, A15, *A16*, *A17*, *A18*, A21, A23, A25, A26, A27, A28, A29, A42, A43, A51;

B01:

B01, B02, B03, B05, B06, B07, B08, B10, B11, B12, B13;

C01:

C01, C02, C03, C04, C05, C06, C07, C08, C09, C10, *C11*, C12, C13, C14, *C15*;

D01:

D01, D02, D03, D04, D05, D07, D08, D09, D10, D11, D12, D13, D14, D15, D16;

G01:

G01, G03, G04, G05, G06, G07, G09, G11, G16, G17, G18, G19, G20, G22, G23, G24, G25, G26, G29, G30, G31, G32, G37, G38, G39, G40;

G12:

G02, G08, G12, G27, G28, G33, G34, G35, G36, G41, G42;

H01:

H01, H02, H03, H04, H05, H06, H07, H08;

I01:

I01, I03, I19, I23, I40, I54, I56;

I02:

I02, I05, I08, I14, I22, I28, I39, I55;

I11:

I04, I10, I11, I12, I13, I15, I16, I27, I37, I41, I42, I43, I44, I47, I51;

I18:

I07, I17, I18, I20, I21, I24, I26, I38, I48, I49, I50, I52, I53;

I31:

I31, I32, I33, I35, I36, I45, I46;

R01:

R01, R02, R03, R04, R05, R06, R07, R08, R09, R10, R11, R12, R13, R14, R15, R17, R18, R19, R20, R21, R22, R23, R24, R25;

W01:

W01, W02, W03, W05;

Unknown: B04

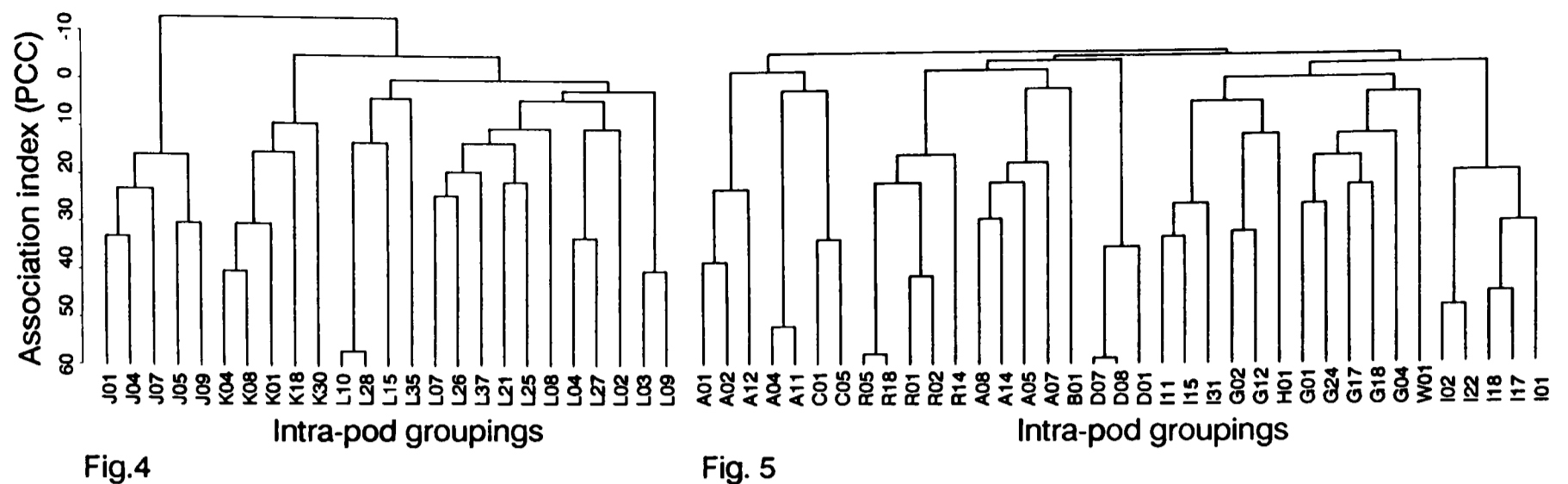

Fig. 4

Fig. 5

Figs 4 and 5. Dendrograms showing associations of intra-pod groups in the southern community (Fig. 4) and the northern community (Fig. 5). The dendrograms are based on the point correlation coefficient (PCC).

dialects (Ford and Fisher, 1982; 1983) and each pod formed a distinct cluster in the association dendrograms (see Figs 4–5 using pod compositions from Table 1).

The southern community was composed of three pods and the northern community of 16 pods (Table 1). The pods designated as A01, A04, A05, B01, C01, D01, H01, I11, J01, K01, L01 and R01 corresponded to those given in Bigg (1982). However, based on additional data, we divided Bigg's (1982) pod G into pods G01 and G12 and his pod I1 into pods I01, I02, I18 and I31. We also revised the size of pod W01. The pods for one individual from the southern community and one from the northern community could not be determined. One calf (B20) was first identified after it had become separated from its pod (Jeune, 1979) and a large juvenile (B04) died within a few days of being identified.

The membership of pods was stable over many years. Bigg (1982) noted that four individuals (J03, J04, J05 and J08) in pod J01 remained in the same pod for at least 13 years. Current data indicate that the same individuals remained together for at least 19 years.

Several resident pods were cropped for exhibits in zoos and aquaria during 1964–73 (Bigg and Wolman, 1975; Bigg, 1982). A total of 34 individuals were known to have been removed from the southern community and 14 from the northern community. All but two of the latter were taken from pod A05. In addition, 14 animals were taken from unknown pods off southern Vancouver Island and one from an unknown pod off northeastern Vancouver Island. These 15 whales may have been removed from either resident or transient pods. However, most were likely to have been taken from resident pods because this was the most abundant form and 90% of the cropped animals of known form were residents. Olesiuk and Bigg (1990) give data on the pod, sex and age of the cropped whales.

3.3 Subpods

Although some pods (e.g. B01, G12, H01, I01, I02, I31, J01, W01) never or rarely (<5%) fragmented into smaller groups, others (A04, A05, I11, I18, K01, L01 and R01) occasionally (5–24%) separated and a few (A01, C01, D01, G01) commonly (25–49%) fragmented. When pods fragmented they generally split into stable units which we termed subpods. Subpods usually separated from their pod for less than a month. They were named after one of their members. Pods comprised 1–3 (mean=1.7) subpods.

The membership of subpods was established (Appendix Table A-B) in the same manner as for pods. The discreteness and membership of subpods was also evident in the association dendrograms (Figs 4–5). In most cases (30 of 32), subpods formed distinct clusters in the dendrograms. The two exceptions were intra-pod groups (defined below) K18 and A05. Direct observations indicated that K18 should have linked to intra-pod group K30 before rather than after intra-pod groups K04–K08–K01. Direct observations also indicated that intra-pod group A05 should have linked to intra-pod group A08 before rather than after intra-pod group A14. Both misplaced intra-pod groups contained adult males, which tended to make intra-pod groups more independent (Section 4.1.4).

3.4 Intra-pod groups

The members of subpods almost always (>95%) travelled together. However, the members of some subpods travelled in discrete and very cohesive groups that we have termed intra-pod groups. An individual only very rarely separated from its intra-pod group for more than a few hours. These groups were named after one of their members. Subpods contained 1–11 (mean=1.9) intra-pod groups and intra-pod groups contained 2–9 (mean=3.6) individuals. The term intra-pod group will be replaced later in the report by the term 'matrilineal group' (see Section 4.1.4).

In almost all cases (50 of 52), the members of each intra-pod group linked in clusters at $\geq 15\%$ CAI in the dendrograms which conformed with intra-pod memberships determined by direct observation. However, direct observations indicated that two adult males were linked to the wrong intra-pod groups. One male (K02) was linked to intra-pod K08 when direct observations indicated it was a member of intra-pod group K01. This error resulted from the small number of photographs taken of K02 which died within a year of being identified. Another male (R01) was placed in group R14 when direct observations indicated that it was a member of group R09. This error probably resulted because adult males occasionally travelled with other unrelated adult males, and intra-pod R14 consisted of two adult males. To prevent these two misplacements from distorting subsequent linkages, we utilized an interactive version of the single-link algorithm that allowed us to reject linkages. Both males were placed in their proper intra-pod groups as a second choice.

The six individuals (A16, A17, A18, C11, C15, J24) that died or were cropped prior to the start of the study were excluded from the association analysis as were four calves (A41, B13, G41, G42) for which there were few photographs. The identity of the intra-pod groups for these individuals was established solely on the basis of direct observations.

The southern community comprised 25 intra-pod groups and the northern community 37 intra-pod groups (Figs 4–5 and Appendix Figs A–T). With the exception of pod L01, pods were made up of 1–5 (mean=2.6) intra-pod groups and subpods 1–4 (mean=1.6) intra-pod groups. Pod L01's three subpods were comprised of 15 intra-pod groups, one sub-pod of which contained 11 intra-pod groups.

4. GENEALOGY

4.1 Genealogies within pods

We established the genealogies among individuals within pods based on the offspring with known mothers and, for other offspring, the relative strength and continuity of their bonds with potential mothers. As will be shown below, the bond between an offspring and its mother lasts for many years and is stronger than that with any other potential mother.

Maternal genealogical trees were constructed cumulatively from the youngest to the oldest offspring. The process involved three basic steps. First, the offspring that were to be incorporated into the tree were selected

beginning with those born during the study, followed by those that were juvenile at the start and finally by those that were mature at the start of the study. Second, the potential mothers of the offspring were identified. All mature females in the offspring's pod were considered as candidates providing that they could have been at least 15 years (mean age of maturity) older than the offspring. However, an offspring's own mature daughters were excluded as potential mothers. We also excluded females that matured during the study after a particular offspring was born so as to ensure that young adult sisters would not be potential mothers. Third, the relative strength of bonds between offspring and all potential mothers were examined. The potential mother with which the offspring was most closely bonded was assumed to be its mother (Section 4.1.2).

The CAI values for all years pooled were arranged into matrices to facilitate comparisons (Figs 6–7; Appendix Figs A–T). One matrix was constructed for each pod, except for pod L01 which was too large to place conveniently in one matrix. Pod L01 was divided into its L10, L35 and L08 subpods. Due to its size, subpod L08 was further divided into: (1) intra-pod groups L07, L08, L21, L25, L26 and L37; and (2) intra-pod groups L02, L03, L04, L09 and L27. Although the splitting of subpod L08 was somewhat artificial, individuals within each set of intra-pod groups generally had higher associations with one another and each set formed a distinct cluster in the association dendrogram (Fig. 4). The 10 individuals (A16, A17, A18,

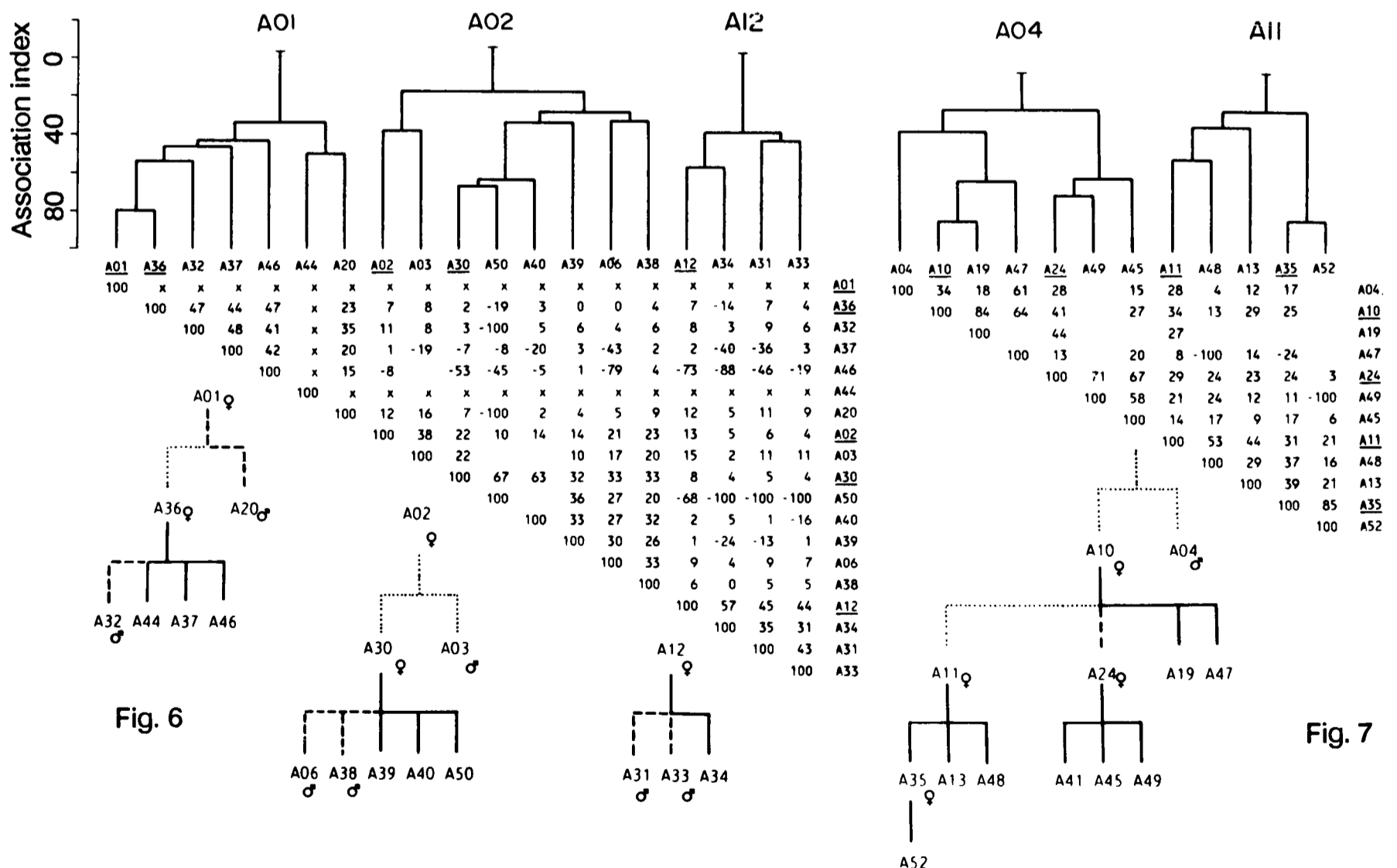

Figs 6 and 7. Genealogy of pod A01 (Fig. 6) and pod A04 (Fig. 7). Cole's association index (CAI) dendrograms showing intra-pod groups (top); matrix of CAI values (middle) and genealogical trees (bottom) based on data for all years pooled. The alpha-numeric codes above each intra-pod group represents their names and the height of the bar the level at which the group links to another intra-pod group. All adult females are underlined in the CAI matrices. CAI values for individuals that were included in the dendrograms, but not in the matrices, are indicated by x's in the matrices. Solid lines in the genealogical trees denote positive genealogies, dashed lines highly probable genealogies and dotted lines probable genealogies. The sexes of individuals that matured prior to or during the study are given in the genealogical trees. The oldest offspring are usually positioned to the left.

C11, C15, J24, A41, B13, G41, G42) that were excluded from the CAI dendrograms were also excluded from the matrices. Six additional individuals (A01, A21, A44, B11, I10, K02) were excluded from the matrices because of photographic bias during 1973–75 (Section 2.5.2) or because there were too few photographs of them. The relative strength of bonds for these 16 whales was assessed solely on the basis of direct observations.

Genealogical assignments were classified into three levels of certainty based on the relative age of the offspring and the likelihood of error in assigning a mother to an offspring: (a) positive genealogies for offspring born during the study and for which the mothers were known (Section 2.3); (b) highly probable genealogies for offspring that were juvenile at the start of the study; and (c) probable genealogies for offspring that were mature at the start of the study.

Identifying the mothers of offspring at the positive and highly probable levels of certainty was usually straightforward, but identifying the mothers of offspring at the probable level was more complex. Although mature offspring exhibited stronger bonds with their mother than with any other potential mother, the bonds were often subtle and varied with time. For example, the bond between a daughter that matured early in the study and her mother generally weakened during the study when the daughter gave birth to her own calves. Similarly, the bond between an adult female and other members of the pod generally weakened when her son matured, because adult males tended to make her intra-pod group more independent (Section 4.1.4). Temporal variations in bond strength were taken into account in direct observations by reassessing bonds each year and in the association analysis by examining the CAI values within the four year-groups. Mother-offspring assignments were also checked for consistency with other lineages in the genealogical trees. Thus, an offspring had to have a sufficiently strong bond with not only its mother, but also with its siblings. Similarly, cross-checking of bonds within matrices was undertaken to ensure that offspring had higher CAI values with their mothers than other potential mothers and that the mother also had high CAI values with the offspring compared to all potential offspring.

An offspring not strongly bonded to any potential mother was not assigned a mother because the mother may have died or been live-captured prior to the start of the study. In some cases, subtle bonds existed between an offspring and its suspected mother, but if the bond was not clearly stronger than with the other potential mothers then the mother was not assigned. Thus, the mothers for some offspring, particularly adult females, were probably not identified. In general, both direct observations and the association analysis indicated the same genealogies. The few discrepancies that existed between the two methods are noted and discussed.

4.1.1 Genealogical trees within pods A01 and A04 – two examples

Pods A01 and A04 were selected to illustrate the procedure used to construct genealogical trees. These pods were chosen for several reasons: (1) the pods were observed and photographed extensively during 1973–87; (2) neither pod was known to have been cropped; and (3) several approaches were required to assign mothers to offspring.

(a) POSITIVE GENEALOGIES

The mothers of the 16 offspring born in these pods during the study were considered to be known based on direct observations (Section 2.3). In pod A01 (Fig. 6), A36 was the mother of A44, A37 and A46; A30 was the mother of A39, A40 and A50; and A12 was the mother of A34. In pod A04 (Fig. 7), A24 was the mother of A41, A45 and A49; A10 was the mother of A19 and A47; A11 was the mother of A35, A13 and A48; and A35 was the mother of A52. Note that A35 was both a daughter and a mother.

The above genealogical assignments were also supported by the association analysis. The known mothers for 14 offspring were also the potential mothers with which the offspring had their highest CAI values. The two exceptions were the offspring that were excluded from the association analyses. A41 was excluded from both the dendrogram and matrix because it had been photographed only a few times and A44 was excluded from the matrix because of photographic bias.

(b) HIGHLY PROBABLE GENEALOGIES

At the start of the study, pod A01 contained juveniles A06, A20, A32, A38, A31 and A33; and pod A04 contained juvenile A24. Direct observations indicated that the mother of A20 was A01; the mother of A32 was A36; the mother of A06 and A38 was A30; the mother of A31 and A33 was A12; and the mother of A24 was A10. To assign mothers to these offspring by association analysis, we assumed that the real mother was the potential mother with which it had its highest CAI value. The association analysis also indicated that these offspring had the same mothers as determined by direct observations. The only exception was A20, which had its highest CAI with its sister A36. The latter discrepancy resulted because A20's mother, A01, had been excluded from the matrices because of photographic bias.

(c) PROBABLE GENEALOGIES

At the start of the study, pod A01 contained adult females A01, A02, A12, A30, A36 and adult male A03, and pod A04 contained adult females A10 and A11 and adult male A04. An important consideration in assigning genealogies at this level was the relative ages of the adult females. For example, females A01 and A02 were likely to be the oldest because they appeared to be post-reproductive (Section 2.4.2) at the start of the study. Adult female A12 was also likely to be among the oldest because she appeared to become post-reproductive early in the study. Female A11 was likely to be the youngest. Although she was adult-size when first seen in 1973, she had no offspring travelling with her, but subsequently gave birth to three calves between 1974 and 1983 and thus appeared to have matured early in the study. Females A10, A30 and A36 were likely to be older than A11 because they had juvenile offspring travelling with them when the study began and continued to calve during the study.

In pod A01, direct observations indicated that A36 and A01 were strongly bonded as were A30 and A02. When relative ages were taken into account, A36 was assigned as the daughter of A01 and A30 as the daughter of A02. The latter assignment was supported by the association analysis which indicated that A30 exhibited a higher CAI value with A02 than with any other potential mother. The assignment of A36 as the daughter of A01 could not be confirmed by the association analysis because A01 was excluded from the CAI matrix. Both direct observations

and CAI values indicated that A12 was not strongly bonded to any potential mother, which suggests that its mother died prior to the start of the study.

Both direct observations and CAI values indicated that the adult male A03 was likely to be the son of A02. Note that the CAI value of the son (A03) with his mother (A02) was higher than that of his sister (A30) and her mother, which was typical for adult sons and adult daughters (Section 4.1.3). In addition, adult males typically had much weaker bonds with their adult sisters than their mothers. This characteristic weaker bond between an adult brother and his adult sister was useful for assigning an adult male as a brother rather than a son in cases where the mother had died prior to the study but his sister remained alive.

In pod A04, direct observations indicated that A11 and A10 were strongly bonded. When relative ages were taken into account, A10 was assigned the mother of A11. This assignment was supported by the high CAI value of A11 with A10. The adult male A04 was probably the brother of A10. He was too old to be the son of either A11 or A24. While his association was slightly higher with A10 than with A11 and A24, it was not high enough to be the son of A10. In addition, when cross-checking was undertaken of the importance of bonds for A04 and A10, it was apparent that A10 did not have the characteristic stronger bond with A04 than with her daughters A11 and A24.

4.1.2 Genealogical trees within all pods

In this section, we construct genealogical trees for all pods in the same manner as for pods A01 and A04 (Appendix Figs A-T). We also show that offspring have a stronger bond with their mother than with any other potential mother, and that this strong bond lasts throughout the mother's lifespan. The evidence for life-long bonding comes from an examination of relative bond strength and the continuity of bonds (1) between offspring and known mothers in the positive category of genealogy and (2) between offspring and potential mothers in the highly probable and probable genealogical categories.

(a) POSITIVE GENEALOGIES

The mothers of the 133 offspring born during the study were known from direct observations. Of the 127 offspring that could be examined by association analysis, all had higher CAI values with their known mother than with any

other potential mothers in their pod. The mothers of four offspring could not be confirmed because the offspring were excluded from the matrices and the mother of one could not be confirmed because the mother was excluded from its matrix.

Direct observations indicated that as offspring aged during the study they maintained their strongest bonds with their known mother. The continuity of the mother-offspring bond was also evident from the high proportion of cases (232 of 238 cases) in which the CAI with the known mother ranked the highest of all potential mothers in the four data year-groups (Table 2). Of the six exceptions, five offspring had their highest CAI values with their grandmother and their second highest with their mother. These exceptions probably occurred by chance due to the small sample sizes in the year-groups. This was indicated by the fact that no exceptions existed for the large sample sizes in all years pooled, 1973–87. Also, the bonding between an offspring and its grandmother is often only slightly less than with its mother because an offspring travels closely with its mother which in turn travels closely with its own mother. At the end of the study, offspring in the positive genealogical category ranged in age from 0.5 to 14.5 years (mean=5.7 years) and five had matured. Thus, the offspring of both sexes maintain strong bonds with their mothers from birth into adolescence and early adulthood.

(b) HIGHLY PROBABLE GENEALOGIES

There was a high probability that the potential mother with which a juvenile was most strongly bonded at the start of the study was also its real mother. The reason is that offspring that were juvenile at the start of the study were of similar ages to those in the positive category at the end of the study; and the latter offspring were still most strongly bonded to their known mothers. The estimated ages (Section 2.4.2) of juveniles in the highly probable category at the start of the study ranged from 1.5 to 20.5 years (mean=8.3 years).

The mothers of 80 juveniles were identified using direct observations. Seventy-seven (96.3%) of the mother assignments were supported by the association analysis. Three juveniles had slightly higher CAI values with a potential mother other than its mother identified by direct observations. Two of these juveniles (L38, L42) had their highest CAI values with their grandmothers and second

Table 2

Continuity of mother-offspring bonds within the year-groups 1973-76, 1977-80, 1981-84 and 1985-87. The CAI values between offspring with their assigned mothers were ranked relative to those between offspring and all other potential mothers in the first and each subsequent year-group an offspring was photographed. Mother-offspring pairs assigned solely on the basis of CAI values were omitted (i.e. all others included direct observations, as were year-groups in which either an offspring or its mother appeared in fewer than 10 photographs. Numbers in parentheses indicate percentages.

Genealogical Category	Rank of CAI	1st year group	2nd year group	3rd year group	4th year group	All year-groups	1973-87 pooled
Positive	1	126 (99.2)	64 (97.0)	31 (91.2)	11 (100.0)	232 (97.5)	127 (100.0)
	2	1 (0.8)	1 (1.5)	3 (8.8)	0 (0.0)	5 (2.1)	0 (0.0)
	±3	0 (0.0)	1 (1.5)	0 (0.0)	0 (0.0)	1 (0.4)	0 (0.0)
Highly Probable	1	77 (97.5)	59 (96.7)	55 (90.2)	38 (92.7)	229 (94.6)	75 (94.9)
	2	2 (2.5)	1 (1.6)	3 (4.9)	2 (4.9)	8 (3.3)	4 (5.1)
	±3	0 (0.0)	1 (1.6)	3 (4.9)	1 (2.4)	5 (2.1)	0 (0.0)
Probable	1	26 (96.3)	22 (88.0)	23 (100.0)	15 (100.0)	86 (95.6)	27 (100.0)
	2	0 (0.0)	0 (0.0)	0 (0.0)	0 (0.0)	0 (0.0)	0 (0.0)
	±3	1 (3.7)	3 (12.0)	0 (0.0)	0 (0.0)	4 (4.4)	0 (0.0)

highest with their mothers; and one (R04) had a higher value with an adult female of unknown relatedness and second highest with its mother. Based solely on the association analysis, two males (L10, K01) were assigned mothers and a third male (J06) was identified as the brother of a female that had no living mother during the study. The latter three bonds were not apparent from direct observations.

The strong bond that existed between each offspring and its highly probable mother was maintained as the juveniles grew older during the study. Direct observations indicated that offspring of both sexes maintained their strong bonds with the highly probable mother throughout the study. As in the positive category, support for this observation was evident from the high proportion of cases (97.5%) where the CAI with the highly probable mother ranked higher than any other potential mother (Table 2). Of the 13 (2.5%) cases in which the mother did not rank the highest, the mother was second to the grandmother in eight. As noted earlier, such errors were to be expected occasionally by chance. By the end of the study, offspring in this category ranged in age from 13.5 to 34.5 (mean=19.7) years. Thus, the strong mother-offspring bond was maintained well into adulthood.

A potential source of error for genealogical assignments in the highly probable category was that the real mother had died prior to the start of the study. In such cases, a juvenile might bond with another adult female. One case was recorded in which this error would have taken place had the study begun later. In this case, the lineage consisted of a grandmother (L25), her daughter (L23) and her grandson (L14). Following the daughter's death in 1982, the grandson travelled mainly with his grandmother, which would then have been mistaken as its mother. However, the frequency of this type of error was probably small because reproductive females had extremely low mortality rates. Based on the mortality rates given in Olesiuk and Bigg (1990), we estimated that 96% of mothers would still be living 8.3 years after they gave birth (i.e. the mean age of juveniles in the highly probable genealogical category at the start of the study). The potential for this error was greater in cropped than uncropped pods, but was probably still small. Most juveniles born to females that were cropped were likely to have been cropped themselves because of the strong mother-offspring bond and the fact that whales were often cropped in groups. Moreover, relatively few adult females were cropped. Of the resident whales removed, 83% were juveniles or mature males (Olesiuk and Bigg, 1990).

(c) PROBABLE GENEALOGIES

The preceding category suggests that adult offspring that had living mothers at the start of the study would still be more strongly bonded with their mothers than with any other potential mother. However, there was a higher probability that the mother of offspring in this category died prior to the start of the study. The likelihood that the mother died prior to the study would be largely a function of the age of the adult offspring, which ranged from about 10 years to at least 40–50 years at the start of the study.

The probable mothers were identified for 34 of the 102 individuals that were adult at the start of the study. The mothers of 24 of these offspring were based on direct observations and were supported by the association analysis. Based on the CAI values, we placed an additional 10 adult offspring to lineages that were not apparent from direct observations. These offspring included one male

(C01) and three females (K11, L07, R07) that were assigned to living mothers, as well as four males (G01, G07, J01, L16) and two females (L26, L37) that did not appear to have living mothers, but were assigned as siblings of living females.

As with the highly probable genealogical category, direct observations indicated that the bond an offspring had with its probable mother established at the start of the study was maintained throughout the study. This finding was supported by the consistently high ranking of CAI values with the probable mother compared to all potential mothers (Table 2). Thus, evidence from the three levels of genealogical certainty suggests that the offspring of both sexes remained bonded to the mother throughout the mother's life.

A possible source of error in the lineages at the probable level of certainty was that young infertile adult females may have been mistakenly classified as old post-reproductive females, in which case the females classified as grandmothers (e.g. A07, G30, L28) would have been daughters. However, the potential for this error was small because infertile females appear to be rare. With one exception (K40), all females that were large juveniles at the start of the study gave birth during the study. Conversely, reproductive senescence appeared to be much more common than infertility because many older females became post-reproductive just prior to or during the study (Olesiuk and Bigg, 1990).

4.1.3 Sex- and age-specific mother-offspring bonds

The change in strength of the mother-offspring bond with age was examined using CAI values for the year-groups 1973–76, 1977–80, 1981–84 and 1985–87. The mean CAI values (\pm SE) were plotted as a function of the estimated age of the offspring at the midpoint of each year-group (Fig. 8). It should be noted that the estimated ages were minimum ages, especially those of adults (Appendix Tables A-B). However, the bias introduced by using minimum ages for adults was likely to be small because changes in the strength of bonds were asymptotic with age.

The bond between a mother and her daughter declined with age until the daughter reached her late teens or early twenties at which time the bond stabilized at a CAI of

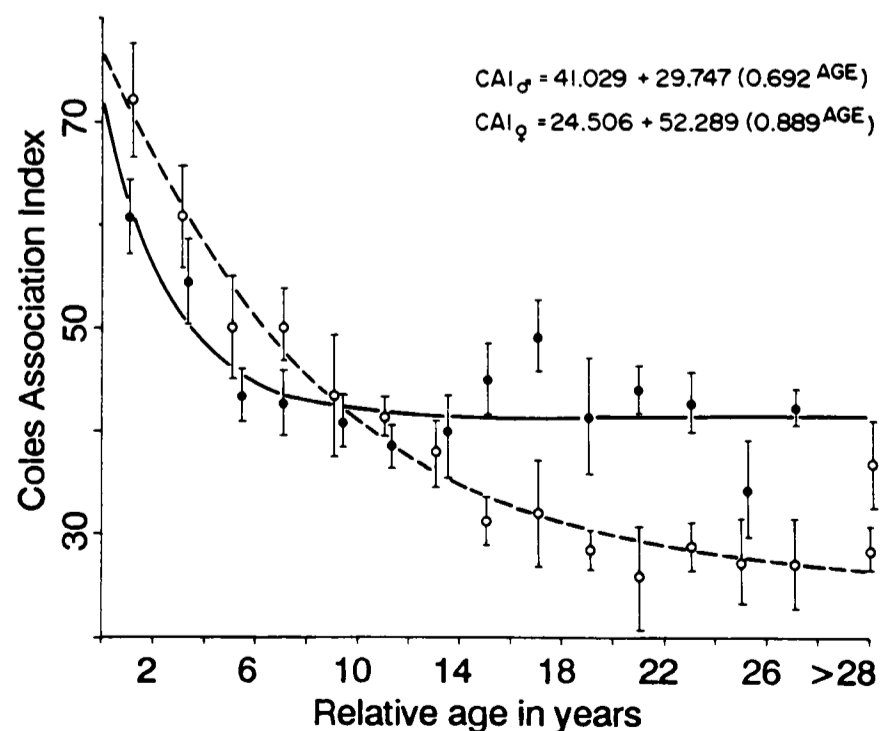

Fig. 8. Changes in mean (\pm SE) Cole's association index (CAI) between male (\bullet) and female (\circ) offspring and their mothers as a function of the offspring's estimated age at the midpoint of each year-group. All offspring of known sex were included ($n=124$).

about 25. The decline with age may be more pronounced than indicated because adult females that were weakly bonded with their mothers may not have been identified as daughters (Section 4.1.4).

The bond between a mother and her son initially declined more rapidly with age than with her daughter, but stabilized by about 10 years of age at a CAI of about 40. Thus, young sons tended to spend more time away from their mothers than did young daughters. However, adult sons remained more closely bonded to their mothers than did adult daughters. Direct observations suggest that the reason for this is that adult daughters travelled closer to their progeny than do their own mothers.

4.1.4 Interpretation of genealogical trees

An examination of the genealogical trees for the intra-pod groups indicated that these groups were matrilineal groups comprising mothers and their descendants. Intra-pod groups are therefore subsequently referred to as matrilineal groups, a term which more appropriately conveys the significance of the group.

Matrilineal groups were made up of 1–4 (mean=2.3) generations, although 2–3 generation groups were the most common. Only one group (R14) was only a single generation and it consisted of two adult males that were probably brothers whose mother had died prior to the study. Three matrilineal groups (J01, K01 and L28) were made up of four generations. In each case the 4th generation was born late in the study (1986–87). Several other matrilineal groups nearly attained four generations. For example, the two first generation members of matrilineal group A04 died 3–4 years prior to the birth of the fourth generation calf. A generalized matrilineal group was comprised of a grandmother, her adult son and adult daughter and the offspring of her daughter.

Only two individuals could not be fitted into the matrilineal groups indicated by their dendrograms. The adult male I10 was placed in group I11, but few data existed for this individual because it died early in the study before many photographs could be taken of its pod. An examination of photographs with more than one individual present indicated that he did not belong clearly to either of the two groups in his pod (Appendix Fig. L). Perhaps the two oldest females in the two matrilineal groups of its pod were his sisters. The other exception was adult female R17 and her offspring. She was placed into group R05 in the dendrogram, but could not be fitted easily into the genealogical tree (Appendix Fig. H). She appeared to be an adult at the start of the study, and had she not given birth late in the study, she would have been considered a post-reproductive female and the mother of R05. However, with the birth of her calf she appeared to be too young to be both a young reproductive female and the mother of R05. Perhaps she was an unusually old reproductive female and the mother of R05.

Some matrilineal groups were linked into extended matrilineal lines. A few were linked by a common mother that was alive during the study (e.g. A04 and A11; J05 and J10; L07 and L37; R04 and R18; D07 and D08). Other groups were linked because the adult female in one was thought to be the mother of an adult female in another (e.g. L04 and L27; A08 and A09; I02 and I22). In a few cases, groups were linked through a common mother that was thought to have died prior to the study (e.g. L07, L26 and L37). Other

linkages between matrilineal groups were likely to have been missed. Sometimes the relative ages of females in two groups were not known precisely enough to be sure which was the potential mother (e.g. groups I17 and I18; G08 and G12). In addition, the bond between two adult sisters was often not strong after their mother died and thus the genealogical relationship between sisters would be missed if the mother died prior to the study.

Another difficulty in linking matrilineal groups was that the bonds sometimes varied with time depending on the presence of adult males in the group. Direct observations indicated that the presence of adult males appeared to make a matrilineal group more independent from other groups within its pod. This was also evident in the dendrograms for groups with at least one adult male, such as K30, L15, L35, A12, G04 and R14, all of which were relatively weakly bonded with other groups in their pod (Figs 4–5).

An example of the sometimes complex travel association that existed among matrilineal groups is illustrated by groups A05 and A08, which we believe were related by way of a mother and her daughter. The dendrogram (Fig. 5) indicated that matrilineal group A08 associated mainly with group A14, rather than its mother's group, A05. The oldest females in groups A08 and A14 were not likely related through mother and daughter because they were of similar ages. Group A09 sometimes left its pod to travel alone or with another pod because the group had two adult sons (A05, A26) that tended to make it more independent. This left the daughter group A08 to travel with other groups in the pod, in this case mainly group A14. When group A09 returned to its pod, group A08 travelled mainly with it suggesting the lineage. On occasions when group A09 left the pod with another group, it invariably did so with group A05, which also indicated close relatedness.

Matrilineal groups appear to have three possible fates. One is for them to die out, as was the case for matrilineal groups K30 and L15 which contained only post-reproductive females and their adult sons (Appendix Figs B-C; and Appendix Table A). This will also likely be the fate of groups G04 and R02 which also comprised post-reproductive females and their adult sons. Alternatively, matrilineal groups may perpetuate themselves for many years by producing a single adult daughter in each generation, as was the case for groups J02 and K07. Third, matrilineal groups may increase in size and divide when several daughters are raised to adulthood, as was the case for groups I18, G12, D07, A10, J09 and L09. We witnessed the formation of two new matrilineal groups during the study. They formed by the gradual splitting of an existing matrilineal group along maternal lines. Each new group formed following the death of the common mother (e.g. A10 and J09) that linked a pair of adult daughters (A24 and A11; J05 and J10); one daughter from each group then formed a new group.

The fate of a matrilineal group depends not only on its sex and age composition, but also on the status of the entire population. In an increasing population, the majority of groups would be growing and dividing, whereas in a decreasing population, the majority of groups would be dying out. A population assessment indicated that both the northern and, prior to capping, the southern communities had been increasing in size since at least 1955 (Olesiuk and Bigg, 1990). Thus, the majority of matrilineal groups were likely to have been increasing in size and dividing during the past few decades.

Following division, matrilineal groups are likely to remain bonded together because no dispersal of matrilineal groups was recorded. Thus, the matrilineal groups within a subpod are probably closely related.

New subpods and ultimately pods probably also form by fission. Thus, the three alternate fates described for matrilineal groups, of dying out, remaining stable or growing, probably exist for subpods and pods. However, the process probably occurs on a much longer time frame than for matrilineal groups. Fission within matrilineal groups can take place within one generation (2–3 decades). The formation of new subpods would take longer, probably many decades and new pods would likely take many decades or even centuries. Pods and subpods that consist of only one matrilineal group (e.g. pods B01, I31, H01, I01; subpod L35) might be the remnants of a group that is dying out or the descendants of a group that is stable over several generations. Pod W01 will likely die out because it contains only a post-reproductive female and her adult sons.

Subpods that grow in size are likely to form new pods. The three subpods in pod A01 and the two subpods in each of the pods A04, C01 and D01 appeared to have spent increasing periods of time apart from one another during the study and thus may be in the process of becoming new pods. As is discussed in Section 4.2, recently formed pods appear to associate with one another, whereas pods showing distant ancestors associate randomly.

4.1.5 Swimming formation

Direct observations indicated that individuals within matrilineal groups usually swam in formations that correlated largely with genealogy. A mother usually surfaced with her offspring clustered beside and slightly behind her (Fig. 9). Thus, matrilineal groups are typically matrifocal in that all other individuals in the group cluster around the adult females. Matrilineal groups contain 0–3 (mean=1.3) adult females. Young juveniles travelled closest to their mothers. Adult sons generally swam next closest, either beside or slightly behind their mothers. Adult daughters were positioned slightly farther from the mother and were in turn followed by their offspring. Siblings usually travelled closely with one another because they all travelled close to their common mothers. An adult male with no living mother, but with a living adult sister, tended to travel on the periphery of her group.

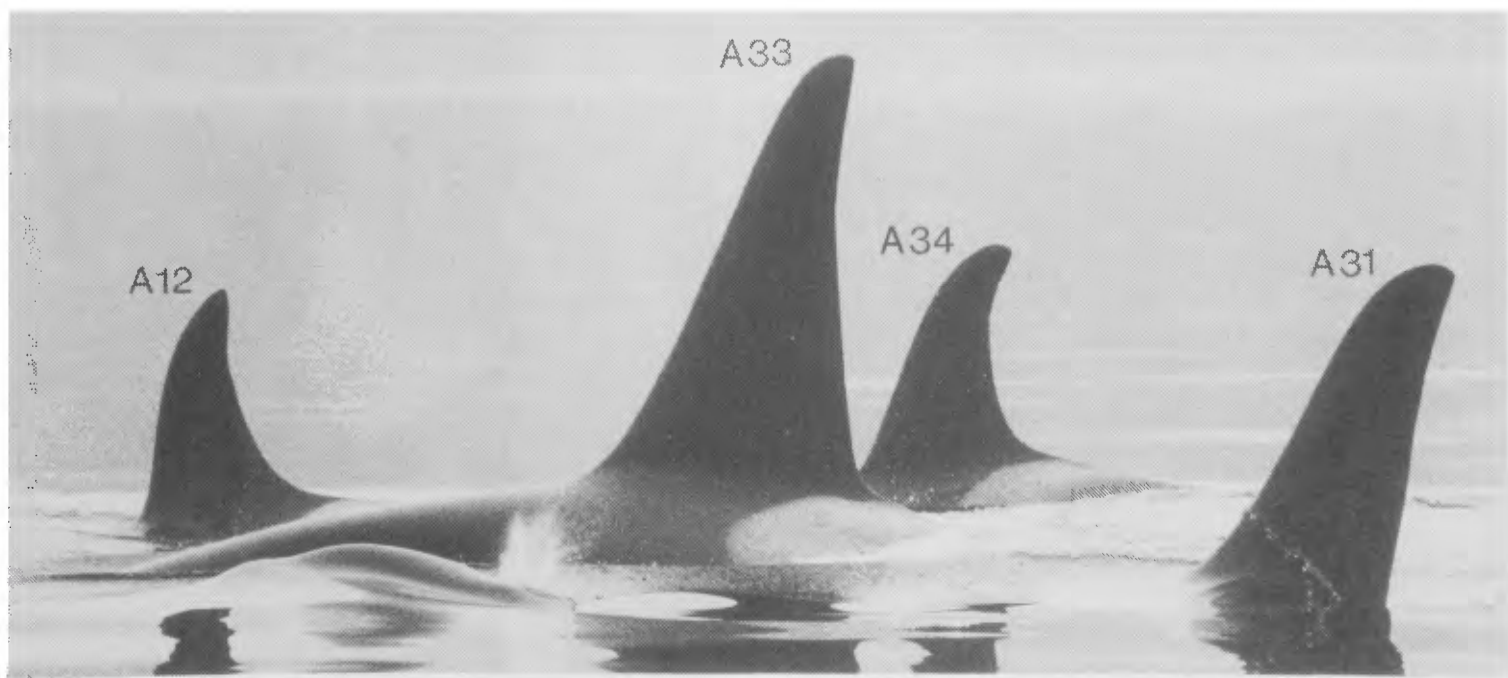

Fig. 9. Typical swimming formation of the members of a matrilineal (intra-pod) group. Matrilineal group A12 is shown with mother A12 followed by her two adult sons, A31 and A33, and juvenile daughter A34. Photo: J. Ford, 12 August 1988.

The distance separating whales in a matrilineal group depended on the activity of the group. Offspring generally stayed within 1–3m of their mother when resting. They were more loosely clustered when travelling or feeding, but usually remained within 10–20m of their mother and seldom ventured more than 100m away. Even when the group was widely dispersed, the offspring were still the individuals travelling closest to their mothers. Bonds weakened among all group members when the pod began to play or when other pods joined and socialized. During these times offspring sometimes travelled with adult females other than their mother or with non-siblings. Unrelated mothers occasionally preferred to travel more closely with each other (e.g. A09 and R09) than with their own offspring. However, individuals usually re-assembled into their own matrilineal group within a few hours.

4.2 Genealogies among pods

Two approaches were used to examine genealogies among pods. First, we determined the degree of association among pods based on the relative strength of bonds among individuals within each community (Fig. 10). Pods G01 and G12 associated quite strongly as did pods I01, I02 and I18, which suggested these pods might be more closely related to one another than to other pods. However, the associations among other pods were weak, which suggested that they travelled almost randomly with one another.

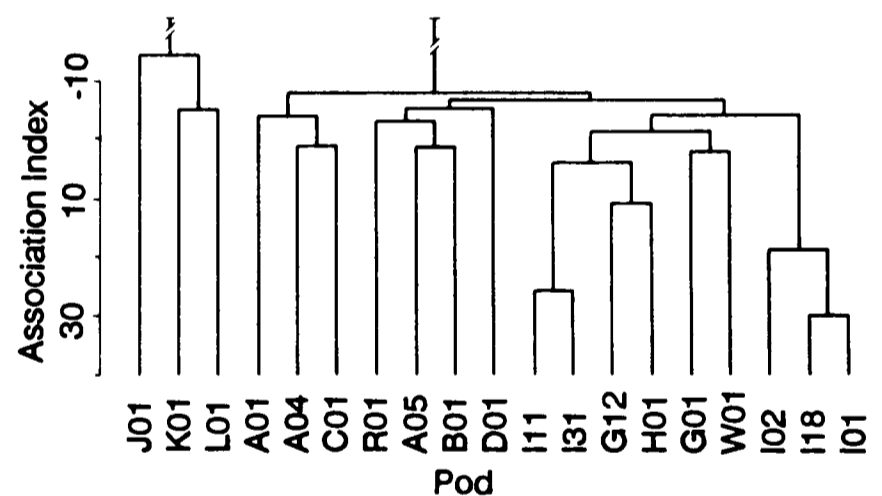

Fig. 10. Dendrogram showing associations of pods in the southern and northern communities (summarized from Figs 4–5).

Second, we examined pod genealogy based on pod-specific dialects. Ford and Fisher (1982; 1983) and Ford (1984) found that resident killer whales in this region made three types of vocalizations, one of which was 'discrete calls'. The discrete calls within pods were stable with time (> 25 years), but varied between pods. Pods that shared discrete calls were considered to belong to the same acoustic 'clan', whereas pods that shared no calls were considered to belong to different clans. Within a clan, each pod produced unique calls or structural variations of calls. In view of the stability of discrete calls with time, Ford (1984) argued that pods within each clan shared a common ancestor and that the degree of similarity of calls among pods within a clan indicated a measure of their genealogical relationship. Pods with similar call repertoires were likely to be more closely related than those with dissimilar repertoires.

The acoustic similarity of pods is shown in Fig. 11, which is Ford's (1984) original Fig. 48 modified to account for the revision of G pod into pods G01 and G12 and of I1 pod into pods I01, I02 and I18 (Section 3.2). The dialects of the revised pods were essentially the same as in the original pods. Thus, Ford's (1984) conclusion that the northern community comprised three acoustic clans remains valid.

A comparison of Figs 10 and 11 indicates that few similarities exist between travel bonds and call repertoires. Both methods suggest that pods G01 and G12 are closely related as are pods I01, I02 and I18. However, in many cases pods tend to associate more strongly with pods outside their acoustic clan than within. For example, the two pods in R Clan (R01 and W01) are acoustically very similar, yet show no tendency to travel together.

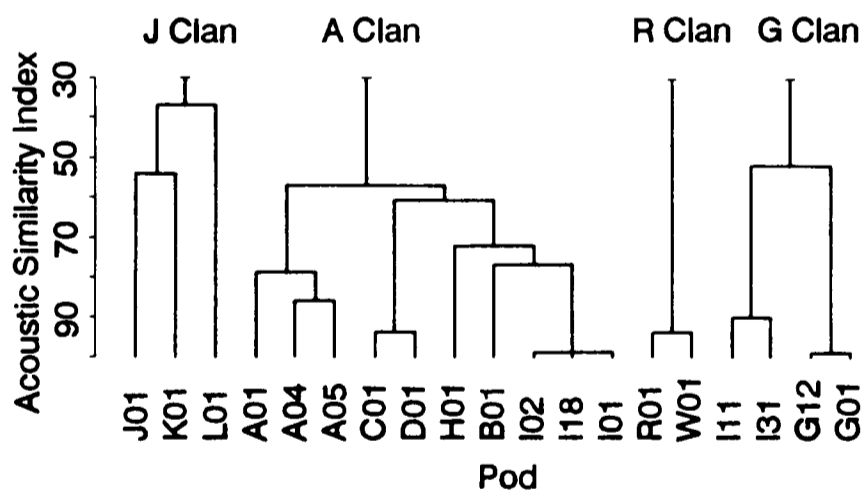

Fig. 11. Acoustic similarity of pods in the southern and northern communities (up-dated version of Fig. 48 in Ford, 1984).

Dialects probably indicate pod genealogies more accurately than do travel associations. The differences in pod-specific dialects are much more distinctive than travel associations. Moreover, discrete calls appear to be more stable than the bonds among individuals related by a common recent ancestor. For example, the presence of adult males tends to make pods more independent as was the case for matrilineal groups. The most independent pod was pod B01, in which six of its 11 members were adult males at some point during the study (Fig. 5). Pod W01 also had a high proportion (50%) of adult males and was nearly as independent.

We conclude that the strength of travel bonds provides a useful index of genealogies for individuals within pods, but is of limited value at the pod level. On the other hand, dialects do not indicate genealogies within pods, but are

useful for identifying pods and for determining genealogies among pods. Thus, acoustic clans are not social units, but rather groupings of pods based only on a common lineage.

5. DISCUSSION

Other studies have reported groups within pods in the northern and southern communities. Jacobsen (1986) observed A01, A04 and A05 pods in Johnstone Strait during 1979–84 and concluded that they comprised maternal groups. Although he did not specify the membership of the groups, they coincided with our matrilineal groups (J. Jacobsen, Humboldt State University, California, pers. comm.). S.L. Heimlich-Boran (1986) observed pod J01 in Haro Strait during 1976–80. The four groups identified in her Fig. 11.10 were the same as our matrilineal groups. Although not yet published, other researchers studying the northern community since the early to mid-1980s have confirmed the membership of pods and their matrilineal groups in pods A01, A04, A05, B01, C01, D01, G12, H01, I02, I11, I31 and W01 and to some extent in pods G01, I01, I18 and R01 (D. Bain, J. Waite, N. Rose, University of California, Santa Cruz; A. Morton, Simoon Sound, British Columbia; J. Jacobson; pers. comm.). Similarly, R. Hoelzel (Cambridge University, England; pers. comm.) examined and confirmed the pods and their matrilineal groups in the three pods (J01, K01 and L01) of the southern community.

No instances of individuals moving between pods have been documented in the literature, but, contrary to our findings, two instances of matrilineal groups moving between pods have been reported. However, an examination of these cases indicated that neither had actually occurred. In the first case, Osborne (1986) stated that matrilineal group K18 (formerly matrilineal group L18) moved permanently from pod L01 to pod K01. In fact, group K18 was always part of pod K01 and we had erred in originally assigning it to be as part of pod L01. When Osborne (1986) observed the group with pod K01, he assumed that it had changed pods. In the second case, Jacobson (1986) reported that matrilineal group C05 (J. Jacobsen, pers. comm.) in pod C01 travelled more frequently with pods A01, A04 and A05 during his study. However, more recent data indicated that, while it still travelled the majority of time with pod C01, it may be in the process of becoming a new pod.

Both Jacobsen (1986) and S.L. Heimlich-Boran (1986) concluded, as we have, that the bonds between offspring and their mothers persisted for many years. Similarly, Morton (1985) observed pods A01, A04 and A05 in the mainland inlets off northeastern Vancouver Island during 1982–85 and noted that individuals travelled in groups of one or two adult females and their offspring. S.L. Heimlich-Boran (1986) commented that pod J01 contained non-reproductive adult females (e.g. J02, J08 and J09) and was uncertain as to their role. Haenel (1986) argued that these females provided allomaternal care. However, our studies indicated that such females were post-reproductive and probably the mothers of the reproductive females in the matrilineal group.

The results of our study indicate that resident killer whales travel in kinship groups and that these groups form the basis of progressively larger social groupings (Table 3). Other mammals, such as canids and primates, have also been reported to travel in kinship groups of siblings and parents (Chepko-Sade and Sade, 1979; McDonald, 1983;

Table 3

Summary of social organization and genealogy of resident killer whales in the study area. No dispersal occurred at any level of organization.

Unit	Composition	Definition	Genealogy
Matrilineal (intra-pod) group	2-9 (mean=3.6) individuals of mixed age and sex	Group of individuals that always travel together and in close proximity to one another (Section 3.4). The groups are matrilineal (Section 4.1.5).	Matriline of 1-4 (mean=2.7) generations (Section 4.1.4).
Subpod	1-11 (mean=1.9) matrilineal groups	Matrilineal group(s) that almost always (>95% of the time) travel with one another (Section 3.3).	Closely related matrilines (Section 4.1.4); matrilines within subpods are more closely related to one another (e.g. share a common mother) than to matrilines in other subpods and matrilines within pods more closely related to one another than to matrilines in other pods.
Pod	1-3 (mean=1.7) subpods	Subpod(s) that travel with one another the majority of the time (Section 3.2). Dialects are pod-specific (Section 4.2).	
Clan	2-10 (mean=4.8) pods	An acoustic grouping of pods that share one or more discrete calls. Most pods exhibit little preference for travelling with other pods within their clan (Section 4.2). Not a social group.	Pods that share a common distant ancestor (Section 4.2). Pods within clans with very similar dialects and which tend to travel together are likely most closely related whereas those with dissimilar dialects are likely most distantly related.
Community	1-3 (mean=2.0) clans	Pods that associate with one another (Section 3.1).	Closed populations.

Trivers, 1985). Individuals that travel in such groups are thought to gain indirect fitness through cooperation with relatives.

Studies of other social species (e.g. Kurland, 1977) have shown that bonds among individuals within matrilineal groups correlate with the degree of relatedness. The degree of relatedness is the proportion of genes shared by any two individuals such that an offspring is more related to its mother than its grandmother (Trivers, 1985). If siblings have different fathers, as is suggested for killer whales from an examination of relative testes sizes (Landino, 1985), then an offspring would be related less to siblings than to its mother and less to cousins and so on. Thus, the relative strength of bonds among individuals within pods of killer whales appeared to be correlated with degree of relatedness.

The absence of emigration and immigration from the natal groups of resident killer whales appears to be unique among mammalian social systems. In all other species, to our knowledge, offspring of one or both sexes leave their natal groups by the time they mature. Dispersal has been documented extensively in the social systems of terrestrial mammals (Greenwood, 1980) and of pinnipeds (Ridgway and Harrison, 1981a; 1981b). For cetaceans, baleen whales generally do not form cohesive groups like odontocetes, although they may form large assemblages for feeding (Norris and Dohl, 1980). Dispersal was found in the few odontocetes that have been examined for this feature (e.g. humpbacked dolphin, bottlenosed dolphin, Hawaiian spinner dolphin, sperm whale; see Norris and Dohl, 1980; Wells, Irving and Scott, 1980). However, dispersal has not been examined for the pilot whale (*Globicephala* spp.) and false killer whale (*Pseudorca crassidens*) which have social systems that appear to be similar to that of killer whales. Kasuya and Marsh (1984) speculated that bonds between female short-finned pilot whales (*G. macrorhynchus*) persisted for life, but males sometimes left the pod at puberty to join bachelor groups.

The reason for the absence of dispersal in the resident form remains unclear. It could result from a particularly strong requirement that reliable and familiar associates be available for hunting or maintaining territorial boundaries. It could also result from a unique breeding strategy.

The absence of dispersal in resident whales may not be characteristic for all populations of the species. Although the social system of the transient form of the killer whale has not yet been examined in detail, it clearly differs from that of the resident form (Bigg *et al.*, 1987). The transient system is similar to that of residents in that offspring appear to maintain long-term bonds with their mothers. Analyses similar to those presented in this paper have indicated that transient pods comprise matrilineal groups spanning up to three generations; again no instances of individuals immigrating into these natal groups have been documented. However, in contrast to the resident form, there appears to be some dispersal of transient matrilineal groups and possibly of individuals. The transient pods are smaller (1-7 individuals; mean=2.7) than those of resident pods (3-49; mean=12.3) and each pod appears to contain no more than one matrilineal group. Thus, the matrilineal groups of the transient form presumably disperse. There also appears to be dispersal of individuals. At least one juvenile male (M03) left its pod and travelled alone. Moreover, a number of transient pods were comprised of solitary adult males.

The resident and transient forms exhibit many other behavioural differences as well as morphological differences (Bigg, Ford and Ellis, 1985; Bigg *et al.*, 1987; Baird and Stacey, 1988; Heimlich-Boran, J.R., 1988; Morton, 1990; Felleman, Heimlich-Boran, J.R., and Osborne, in press). A striking difference in their foraging habits may be an important determinant of their differences in social behaviour. MacDonald (1983) reported that foraging patterns can influence social organization in mammals. Transients feed extensively on marine mammals, whereas residents feed mainly on fish.

Although transients have been observed in the same vicinity that residents were feeding on salmon, transients appeared to ignore this food source. Conversely, residents have been observed in close proximity to other species of marine mammals, but ignored this prey.

The different strategies required to hunt marine mammals and fish may have resulted in the development of other behavioural differences. The large pods of the resident form may be more efficient at locating prey that has a patchy distribution, such as salmon. The predictable travel patterns observed in resident pods, their seasonal movements and congregation in Johnstone and Haro Straits during summer months may reflect the familiarity of residents with the seasonal migration routes of salmon. Conversely, the small pods of the transient form may be more efficient at capturing prey that occur in small groups, such as seals, sea lions and porpoises. The irregular travel and dive patterns and infrequent vocalizations which characterize transients may be part of their strategy to hunt wary prey. The fact that the transients and residents are sympatric but do not mix, probably reflects the non-competitiveness of their foraging strategies. On the other hand, the existence of separate ranges for the southern and northern communities suggests competition and this exclusion exists between resident communities.

Additional studies will be required to ascertain how representative our findings on the resident and transient social systems are of killer whales in other regions. Photo-identification studies indicate that both resident and transient forms of killer whales occur in the eastern Gulf of Alaska (Leatherwood, Balcomb, Matkin and Ellis, 1984; von Ziegeler, Ellis, Matkin and Goodwin, 1986). Preliminary analysis of the Alaskan data by one of us (G.M.E.) suggests that the resident pods were comprised of intra-pod groups similar to those in our study, but genealogies have not been examined. Photo-identification studies in Iceland, Norway and the Crozet Archipelago indicate that killer whales travelled in stable groups of 5–29 individuals (Lyrholm, Leatherwood and Sigurjónsson, 1987; Sigurjónsson, Lyrholm, Leatherwood, Jonsson and Vikingsson, 1988; Lyrholm, 1988; Lein J., Christensen, Lein M. and Jones, 1988; Guinet, 1988). However, none of these studies established whether more than one form of killer whale occurred or whether intra-pod groups were present.

Berzin and Vladimirov (1983) used carcasses and field observations to report the existence of a second species of killer whale in the Antarctic, termed *O. glacialis*. However, the new species designation has not been generally accepted (Heyning and Dahlheim, 1988). They reported that the *O. orca* form travelled in groups of 10–15 individuals and fed extensively on marine mammals and the *O. glacialis* form travelled in groups of 150–200 and fed mainly on fish. Thus, the *O. orca* form resembles transients and the *O. glacialis* form resembles residents. As with the residents and transients, the two Antarctic forms occurred in the same vicinity, but did not mix.

The fact that different social systems exist within a species is not unusual. Some species alter their behaviour depending on the environmental circumstances and may alternate between territorial and nonterritorial, monogamy and polyandry or large and small groups (Lott, 1984). Behavioural variations can also result from differences in genotypes, experience or culture and may change daily or gradually over many years. However, it is unusual to find variations in social systems at the same

place and time in one species, as exists in the resident and transient forms of killer whale. Perhaps this species has been able to evolve sympatric races that have different behaviours through strong social isolation. Strong social isolation existed at each level of social organization that we observed in the resident form. The species is intelligent, long-lived and has long-term maternal bonds and these features would make learning and traditions important components in the development of social isolation. Thus, localized populations may well have developed a range of social systems over the cosmopolitan distribution of this species.

ACKNOWLEDGEMENTS

This work was undertaken with the help of many dedicated associates. Over the years the following people provided a large number of photographs or field observations: D. Bain, R. Baird, K. Balcomb-Bartok, L. Barrett-Lennard, R. Chandler, B. Curtis, J. Darling, D. De Rousie, F. Felleman, C. Goebel, N. Haenal, S. Healy, S. and J. Heimlich-Boran, K. Heise, R. and K. Hobbs, R. Hoelzel, J. Jacobsen, M. Lough, E. Mathews, A. Morton, R. Osborne, P. Stacey, The Whale Museum, B. Todd, J. Waite, E. White, C. Whiting and C. Young. Several thousand people helped us locate whales by calling us whenever they saw them and often took photographs of the whales for us.

Particular thanks go to I. MacAskie who made important contributions to the project during the early years. Also, the insightful observations of D. Bain and the many discussions with him have contributed substantially to our understanding of the social organization and genealogies within the northern community of killer whales.

We are indebted to the following organizations for financial or logistic support for this work: Arctic Biological Station, Department of Fisheries and Oceans, Ste. Anne de Bellevue, Quebec; Center for Whale Research, Friday Harbor, Washington; Confidence Foundation, South Pasadena, California; Department of Supply and Services, Department of Fisheries and Oceans, Ottawa, Ontario; Department of Zoology, University of British Columbia, Vancouver, British Columbia; Island Foundation, Marion, Massachusetts; National Marine Mammal Laboratory, Seattle, Washington; Pacific Biological Station, Department of Fisheries and Oceans, Nanaimo, British Columbia; Sealand of the Pacific, Victoria, British Columbia; Stubbs Island Charters, Telegraph Cove, British Columbia; Vancouver Public Aquarium, Vancouver, British Columbia; and West Coast Whale Research Foundation, Vancouver, British Columbia.

We also thank two anonymous reviewers for critical comments.

REFERENCES

- Baird, R. W. and Stacey, P. J. 1988. Foraging and feeding behavior of transient killer whales. *Whalewatcher (J. Amer. Cetacean Soc.)* 22:11–15.
- Balcomb, K. C., Boran, J. R. and Heimlich, S. L. 1982. Killer whales in Greater Puget Sound. *Rep. int. Whal. Commn* 32: 681–5.
- Balcomb K. C. and Bigg, M. A. 1986. Population biology of the three resident killer whale pods in Puget Sound and off southern Vancouver Island, pp. 85–95. *In*: B. C. Kirkevold and J. S. Lockard (eds.) *Behavioral Biology of Killer Whales*. Zoo Biology Monographs, Vol. 1. Alan R. Liss, Inc. New York, N. Y. 457pp.

- Berzin, A. A. and Vladimirov, V. L. 1983. A new species of killer whale (Cetacea, Delphinidae) from Antarctic waters. *Zool. Zh.* 62: 287-95. (Translated by S. Pearson, Natl. Marine Mammal Laboratory, Seattle, Washington).
- Bigg, M. A. 1982. An assessment of killer whale (*Orcinus orca*) stocks off Vancouver Island, British Columbia. *Rep. int. Whal. Commn* 32: 655-66.
- Bigg, M. A., Ellis, G. and Balcomb, K. C. 1986. The photographic identification of individual cetaceans. *Whalewatcher (J. Amer. Cetacean Soc.)* 20: 10-12.
- Bigg, M. A., Ellis, G.M., Ford, J. K. B. and Balcomb, K.C. 1987. *Killer Whales: A Study of their Identification, Genealogy and Natural History in British Columbia and Washington State*. Phantom Press, Nanaimo, British Columbia. 79pp.
- Bigg, M.A., Ford, J. K. B. and Ellis, G. M. 1985. Two sympatric forms of killer whales off British Columbia and Washington. Presented to the Sixth Conference on the Biology of Marine Mammals, Vancouver, Canada, November 1985 (unpublished).
- Bigg, M. A. and Wolman, A. A. 1975. Live-capture killer whale (*Orcinus orca*) fishery, British Columbia and Washington State 1962-72. *J. Fish. Res. Bd Can.* 32: 1213-21.
- Chepko-Sade, B. D. and Sade, D. S. 1979. Patterns of group splitting within matrilineal kinship groups. *Behav. Ecol. Sociobiol.* 5: 67-86.
- Cole, L. C. 1949. The measurement of interspecific association. *Ecol.* 30: 411-24.
- Felleman, F. L., Heimlich-Boran, J. R. and Osborne, R. *In press*. Feeding ecology of the killer whale (*Orcinus orca*) in the Pacific Northwest. In: K. Pryor and K.S. Norris (eds.). *Dolphin Societies and How We Study Them*. Univ. Calif. Press, Calif., Berkeley.
- Ford J. K. B. 1984. Call traditions and dialects of killer whales (*Orcinus orca*) in British Columbia. PhD thesis, University of British Columbia, Vancouver, British Columbia. 435pp.
- Ford, J. K. B. and Fisher, H. D. 1982. Killer whale (*Orcinus orca*) dialects as an indicator of stocks in British Columbia. *Rep. int. Whal. Commn* 32: 671-9.
- Ford, J. K. B. and Fisher, H. D. 1983. Group-specific dialects of killer whales (*Orcinus orca*) in British Columbia, pp. 129-61. In: R. Payne (ed.) *Communication and Behavior of whales*. AAAS Selected Symposium 76. Boulder, Co. 643pp.
- Greenwood, P. J. 1980. Mating systems, philopatry and dispersal in birds and mammals. *Anim. Behav.* 28: 1140-62.
- Guinet, G. 1988. Historique de la presence d'orgues autour de L'Ile de la Possession, Archipel Crozet: 1964-1986. *Mammalia* 52 (2): 285-9.
- Haenel, N. J. 1986. General notes on the behavioral ontogeny of Puget Sound killer whales and the occurrence of allomaternal behavior, pp. 285-300. In: B.C. Kirkevold and J.S. Lockard (eds.) *Behavioral Biology of Killer Whales*. Zoo Biology Monographs, Vol. 1. Alan R. Liss, Inc. New York, N. Y. 457pp.
- Heimlich-Boran, J. R. 1986. Fishery correlations with the occurrence of killer whales in greater Puget Sound, pp. 113-31. In: B.C. Kirkevold and J.S. Lockard (eds.) *Behavioral Biology of Killer Whales*. Zoo Biology Monographs, Vol. 1. Alan R. Liss, Inc. New York, N. Y. 457pp.
- Heimlich-Boran, J. R. 1988. Behavioral ecology of killer whales (*Orcinus orca*) in the Pacific Northwest. *Can. J. Zool.* 66: 565-78.
- Heimlich-Boran, S. L. 1986. Cohesive relationships among Puget Sound killer whales, pp. 251-84. In: B.C. Kirkevold and J.S. Lockard (eds.) *Behavioral Biology of Killer Whales*. Zoo Biology Monographs, Vol. 1. Alan R. Liss, Inc. New York, N. Y. 457pp.
- Heyning, J. E. and Dahlheim, M. E. 1988. Mammalian species No. 304, *Orcinus orca*. *Amer. Soc. Mammalogists.* 15 (January 1988): 1-9.
- Jacobsen, J. K. 1986. The behavior of *Orcinus orca* in Johnstone Strait, British Columbia, pp. 135-85. In: B.C. Kirkevold and J.S. Lockard (eds.) *Behavioral Biology of Killer Whales*. Zoo Biology Monographs, Vol. 1. Alan R. Liss, Inc. New York, N. Y. 457pp.
- Jeune, P. 1979. *Killer whale, the Saga of Miracle*. McClelland, Toronto. 190pp.
- Johnson, S. C. 1967. Hierarchical clustering schemes. *Psychometrika* 32: 241-54.
- Kendall, M. G. and Stuart, A. 1967. *The Advanced Theory of Statistics. Vol. 2. Inference and relationship*. Hafner Publ. Co., New York. 690pp.
- Kasuya, T. and Marsh, H. 1984. Life history and reproductive biology of the short-finned pilot whale, *Globicephala macrorhynchus*, off the Pacific coast of Japan. *Rep. int. Whal. Commn* (special issue 6): 259-310.
- Kurland, J. A. 1977. Kin selection in the Japanese monkey. *Contrib. Primatol.* 12. Basel: Karger.
- Landino, S. W. 1985. Cetacean breeding systems revealed by interspecific comparison. Presented to the Sixth Conference on the Biology of Marine Mammals, Vancouver, Canada, November 1985 (unpublished).
- Leatherwood, S., Balcomb K. C. III, Matkin, C. O. and Ellis, G. 1984. Killer whales (*Orcinus orca*) of southern Alaska. Results of Field Research 1984. Prel. Rep. Hubbs Sea World Research Institute Technical Report No. 84-175. 59pp.
- Lien, J., Christensen I., Lien, M. and Jones, P.W. 1988. A note on killer whales (*Orcinus orca*) near Svolvær, Norway in November-December, 1984. *Rit. Fisk.* 11:95-8
- Lott, D. F. 1984. Intraspecific variation in the social systems of wild vertebrates. *Behaviour* 88: 266-325.
- Lyrholm, T., Leatherwood, S. and Sigurjónsson, S. 1987. Photo-identification of killer whales (*Orcinus orca*) off Iceland, October 1985. *Cetology* 52: 1-14.
- Lyrholm, T. 1988. Photo-identification of killer whales, (*Orcinus orca*) off the coast of Norway, 1983-86. *Rit. Fisk.* 11:89-94
- MacDonald, D. W. 1983. The ecology of carnivore social behaviour. *Nature* 301: 379-84.
- Morton, A. 1985. The development of an ethogram for the northern Vancouver Island, British Columbia, *Orcinus orca* during the fall, winter and spring. *Cetus* 6 (1): 17.
- Morton, A. 1990. A quantitative comparison of behaviour in resident and transient killer whales of the central British Columbia coast. Paper SC/A88/P17 (published in this volume).
- Norris, K. S. and Dohl, T. P. 1980. Structure and function of cetacean schools, pp. 211-61. In: L. M. Herman (ed) *Cetacean Behavior: mechanisms and functions*. John Wiley and Sons, Inc., New York, N. Y. 463pp.
- Olesiuk, P. F., Bigg, M. A. and Ellis, G. 1990. Life history and population dynamics of resident killer whales (*Orcinus orca*) in the coastal waters of British Columbia and Washington State. Paper SC/A88/ID3 (published in this volume).
- Osborne, R. W. 1986. A behavioral budget of Puget Sound killer whales, pp. 211-49. In: B. C. Kirkevold and J.S. Lockard (eds.) *Behavioral Biology of Killer Whales*. Zoo Biology Monographs, Vol. 1. Alan R. Liss, Inc. New York, N. Y. 457pp.
- Osborne, R., Calambokidis, J. and Dorsey, E. M. 1988. *A Guide to Marine Mammals of Greater Puget Sound, including a Catalog of Individual Orca and Minke Whales*. Island Publishers. Anacortes, Washington. 191pp.
- Poole, R. W. 1974. *An Introduction to Quantitative Ecology*. McGraw-Hill Book Co., New York. 532pp.
- Ridgway, S. H. and Harrison, R. J. (eds.). 1981a. *Handbook of Marine Mammals. Vol. 1. The Walrus, Sea Lions, Fur Seals and Sea Otter*. Academic Press, London. 235pp.
- Ridgway, S. H. and Harrison R. J. (eds.). 1981b. *Handbook of Marine Mammals. Vol. 2. Seals*. Academic Press, London. 359pp.
- Sigurjónsson, J., Lyrholm, T., Leatherwood, S., Jonsson, E. and Vikingsson, G. 1988. Photo-identification of killer whales, *Orcinus orca*, off Iceland, 1981 through 1986. *Rit. Fisk.* 11:99-114.
- Sugarman, P. 1984. *Field Guide to the Orca Whales of Greater Puget Sound and Southern British Columbia*. The Whale Museum, Friday Harbor, Washington. 27pp.
- Trivers, R. 1985. *Social Evolution*. Benjamin Cummings, Menlo Park, California. 429pp.
- von Ziegeler, O., Ellis, G., Matkin, C. and Goodwin, B. 1986. Repeated sightings of identifiable killer whales (*Orcinus orca*) in Prince William Sound, Alaska 1977-1983. *Cetus* 6(2): 9-13.
- Wells, R. S., Irvine, A. B. and Scott, M. D. 1980. The social ecology of inshore odontocetes, pp. 263-317. In: L. M. Herman (ed) *Cetacean Behavior: Mechanisms and Functions*. John Wiley and Sons, Inc., New York, N. Y. 463pp.

[Appendix Tables and Figs are on the following 6 pages]

Appendix

DATA ON EACH INDIVIDUAL IN BOTH COMMUNITIES

KEY TO APPENDIX TABLES A AND B

1. Pod (Sub-MAT): the individual's pod, subpod and matrilineal (intra-pod) group.
2. ID: the individual's identification code.
3. Mom: the individual's mother. Mothers were identified on the basis of both direct observations and CAI values, unless indicated with superscripts: a- mother assigned solely on the basis of association analysis; d- mother assigned solely on the basis of direct observations.
4. Sex: M= male; F= female; ?=sex unknown
5. Cat: the category of the individual at start of study (and the level of certainty of the identity its mother - see Section 4.1): B- born during study (positive). J- juvenile at the start of the study; sexually immature for females and physically immature for males (highly probable). A- adult at the start of the study; sexually mature for females and physically mature for males (probable).
6. Min.Age: the year of birth used to estimate the minimum age of individuals (see Section 2.4.2). Superscripts denote the method used to establish the latest possible year of birth; all births between June and July were assumed to have taken place on 1 January: b- year of birth known; e- estimated based on body-size when first seen; m- estimated by subtracting mean age at maturity from year matured; o- estimated by subtracting mean age of maturity from age of oldest presumed offspring; p- estimated by subtracting mean age of physical maturity from year first seen as physically mature animal.
7. Est.Age: the year of birth used to estimate the actual age of individuals in Olesiuk and Bigg (1990). Superscripts denote the ageing method used and nominal accuracy of the age estimates as given in Table 3.1 of Olesiuk and Bigg (1990). Although these estimates are considered to be the most accurate, they were not utilized in the construction of the genealogical trees because they were derived subsequent to the genealogies.
8. First: the year in which the individual was first identified, which in most cases represents the year its pod was first encountered. However, individuals were sometimes identified in photographs taken prior to the start of the study.
9. Last: the year in which the individual was last seen.
10. Died: the year, or range of years, in which the individual died; Superscripts denote the following special cases: c- taken in live-capture fishery prior to start of the study; n- died as neonate (i.e. <0.5 years of age).

Appendix Table A

Registry of all individuals in the southern resident community.

Pod(Sub-MAT)										Year of birth					Seen				
Pod(Sub-MAT)	ID	Mom	Sex	Cat	Min.Age	Est.Age	First	Last	Died	Pod(Sub-MAT)	ID	Mom	Sex	Cat	Min.Age	Est.Age	First	Last	Died
J01(J01-J01)	J01		M	A	≤ 1951 ^p	≤ 1951 ⁱ	1972	1987		K01(K18-K18)	K21	K18	?	B	1986 ^b	1986 ^a	1986	1987	
J01(J01-J01)	J02		F	A	≤ 1942 ^o	1911 ^f	1972	1987		K01(K18-K30)	K30		F	A	≤ 1938 ^o	1929 ^f	1974	1982	1982
J01(J01-J01)	J12	J02	F	A	≤ 1957 ^o	1935 ^e	1972	1987		K01(K18-K30)	K19	K30	M	A	≤ 1953 ^p	≤ 1953 ⁱ	1974	1984	1984
J01(J01-J01)	J24	J12	?	-	1972 ^b	-	1972	1972	1972 ^c	L01(L08-L07)	L07	L37 ^a	F	A	≤ 1962 ^o	1961 ^c	1971	1987	
J01(J01-J01)	J14	J12	F	B	1974 ^b	1974 ^a	1974	1987		L01(L08-L07)	L53	L07	?	B	1977 ^b	1977 ^a	1977	1987	
J01(J01-J01)	J23	J14	?	B	1987 ^b	1987 ^a	1987	1987		L01(L08-L07)	L76	L07	?	B	1987 ^b	1987 ^a	1987	1987	
J01(J01-J04)	J06		M	J	1956 ^m	1956 ^b	1969	1987		L01(L08-L26)	L16		M	A	≤ 1949 ^p	≤ 1949 ⁱ	1970	1978	1978
J01(J01-J04)	J08		F	A	≤ 1942-3 ^o	1933 ^f	1968	1987		L01(L08-L26)	L26		F	A	≤ 1957-8 ^o	1956 ^f	1971	1987	
J01(J01-J04)	J04	J08	F	A	≤ 1957-8 ^o	1957 ^d	1968	1987		L01(L08-L26)	L60	L26	F	J	1972-3 ^e	1972-3 ^b	1974	1987	
J01(J01-J04)	J11	J04	F	J	1972-3 ^e	1972-3 ^b	1974	1987		L01(L08-L26)	L52	L26	?	B	1980 ^b	1980 ^a	1980	1983	1983
J01(J01-J04)	J15	J04	M	B	1976 ^b	1976 ^a	1976	1981	1981	L01(L08-L26)	L71	L26	?	B	1986 ^b	1986 ^a	1986	1987	
J01(J01-J04)	J19	J04	F	B	1979 ^b	1979 ^a	1979	1987		L01(L08-L37)	L37		F	A	≤ 1957 ^o	1933 ^e	1974	1984	1984
J01(J01-J04)	J21	J04	?	B	1982 ^b	1982 ^a	1982	1983	1983	L01(L08-L37)	L43	L37	F	J	1972 ^e	1972 ^b	1974	1987	
J01(J01-J07)	J07		F	A	≤ 1938 ^o	1939 ^f	1972	1983	1983	L01(L08-L37)	L72	L43	?	B	1986 ^b	1986 ^a	1986	1987	
J01(J01-J07)	J03	J07	M	J	1953 ^m	1953 ^b	1968	1987		L01(L08-L21)	L21		F	A	≤ 1959 ^o	1938 ^e	1974	1987	
J01(J01-J07)	J16	J07	F	J	1972-3 ^e	1972-3 ^b	1974	1987		L01(L08-L21)	L47	L21	F	B	1974 ^b	1974 ^a	1974	1987	
J01(J01-J05)	J05	J09	F	A	≤ 1956-7 ^o	1938 ^e	1968	1987		L01(L08-L21)	L48	L21	?	B	1977 ^b	1977 ^a	1977	1983	1983
J01(J01-J05)	J13	J05	F	J	1971-2 ^e	1971-2 ^b	1974	1980	1980	L01(L08-L25)	L25		F	A	≤ 1942-3 ^o	1928 ^f	1974	1987	
J01(J01-J05)	J17	J05	F	B	1977 ^b	1977 ^a	1977	1987		L01(L08-L25)	L23	L25	F	A	≤ 1957-8 ^o	1952 ^f	1974	1982	1982
J01(J01-J09)	J09		F	A	≤ 1941-2 ^o	1917 ^d	1972	1985	1985	L01(L08-L25)	L14	L23	M	J	1972-3 ^e	1972-3 ^b	1974	1987	
J01(J01-J09)	J10	J09	F	A	≤ 1963 ^o	1962 ^c	1972	1987		L01(L08-L25)	L49	L23	?	B	1979 ^b	1979 ^a	1979	1980	1980
J01(J01-J09)	J18	J10	M	B	1978 ^b	1978 ^a	1978	1987		L01(L08-L08)	L45	L66	F	A	≤ 1960 ^o	1938 ^e	1974	1987	
J01(J01-J09)	J20	J10	?	B	1981 ^b	1981 ^a	1981	1987		L01(L08-L08)	L36	L45	?	B	1975 ^b	1975 ^a	1975	1975	1975 ⁿ
J01(J01-J09)	J22	J10	F	B	1985 ^b	1985 ^a	1985	1987		L01(L08-L08)	L57	L45	M	B	1977 ^b	1977 ^a	1977	1987	
K01(K01-K04)	K04		F	A	≤ 1956-7 ^o	1933 ^e	1974	1987		L01(L08-L08)	L08	L66	M	J	1958 ^m	1958 ^b	1970	1977	1977
K01(K01-K04)	K12	K04	F	J	1971-2 ^e	1971-2 ^b	1974	1987		L01(L08-L04)	L04		F	A	≤ 1950 ^o	1938 ^e	1974	1987	
K01(K01-K04)	K22	K12	?	B	1987 ^b	1987 ^a	1987	1987		L01(L08-L04)	L61	L04	M	J	1973 ^e	1973 ^b	1974	1987	
K01(K01-K08)	K08		F	A	≤ 1938 ^o	1930 ^f	1967	1987		L01(L08-L04)	L55	L04	?	B	1977 ^b	1977 ^a	1977	1987	
K01(K01-K08)	K05	K08	M	J	1953 ^m	1953 ^b	1967	1987		L01(L08-L27)	L27	L04	F	A	≤ 1965 ^o	1965 ^c	1974	1987	
K01(K01-K08)	K03	K08	F	A	≤ 1956-7 ^o	1954 ⁱ	1974	1987		L01(L08-L27)	L62	L27	?	B	1980 ^b	1980 ^a	1980	1987	
K01(K01-K08)	K15	K03	?	J	1971-2 ^e	1971-2 ^b	1974	1975	1975	L01(L08-L27)	L68	L27	?	B	1985 ^b	1985 ^a	1985	1987	
K01(K01-K08)	K14	K03	M	B	1977 ^b	1977 ^a	1977	1987		L01(L08-L02)	L02		F	A	≤ 1947 ^o	1945 ^d	1974	1987	
K01(K01-K08)	K16	K03	?	B	1985 ^b	1985 ^a	1985	1987		L01(L08-L02)	L06	L02	M	J	1962 ^m	1962 ^b	1974	1983	1983
K01(K01-K01)	K07		F	A	≤ 1938 ^o	1910 ^d	1972	1987		L01(L08-L02)	L39	L02	M	B	1975 ^b	1975 ^a	1975	1987	
K01(K01-K01)	K02	K07	M	A	≤ 1953 ^p	≤ 1953 ⁱ	1974	1974	1974	L01(L08-L02)	L67	L02	?	B	1985 ^b	1985 ^a	1985	1987	
K01(K01-K01)	K01	K07 ^a	M	J	1955 ^m	1955 ^b	1967	1987		L01(L08-L03)	L03	L09	F	A	≤ 1948 ^o	1946 ^d	1974	1987	
K01(K01-K01)	K11	K07 ^a	F	A	≤ 1957 ^o	1933 ^e	1974	1987		L01(L08-L03)	L33	L03	M	J	1963 ^m	1963 ^b	1974	1987	
K01(K01-K01)	K13	K11	F	J	1972 ^e	1972 ^b	1974	1987		L01(L08-L03)	L51	L03	F	J	1973-4 ^c	1973-4 ^b	1974	1987	
K01(K01-K01)	K20	K13	?	B	1986 ^b	1986 ^a	1986	1987		L01(L08-L03)	L59	L03	?	B	1979 ^b	1979 ^a	1979	1979	1979 ⁿ
K01(K18-K18)	K18		F	A	≤ 1950 ^o	1948 ^d	1974	1987		L01(L08-L03)	L74	L03	?	B	1986 ^b	1986 ^a	1986	1987	
K01(K18-K18)	K40	K18	F	J	1965 ^e	1965 ^b	1974	1987		L01(L08-L09)	L09		F	A	≤ 1933 ^o	1931 ^f	1974	1987	
K01(K18-K18)	K17	K18	M	J	1966 ^m	1966 ^b	1974	1987		L01(L08-L09)	L05	L09	F	A	≤ 1965 ^o	1964 ^c	1974	1987	
K01(K18-K18)	K46	K18	?	B	1974 ^b	1974 ^a	1974	1981	1981	L01(L08-L09)	L58	L05	?	B	1980 ^b	1980 ^a	1980	1987	

[Continued]

Pod(Sub-MAT)	ID	Mom	Sex	Cat	Year of birth		Seen		
					Min.Age	Est.Age	First	Last	Died
L01(L08-L09)	L73	L05	?	B	1986 ^b	1986 ^a	1986	1987	
L01(L10-L10)	L12		F	A	≤ 1943 ^o	1933 ^f	1974	1987	
L01(L10-L10)	L11	L12	F	A	≤ 1958 ^o	1957 ^d	1974	1987	
L01(L10-L10)	L42	L11 ^d	M	J	1973 ^e	1973 ^b	1974	1987	
L01(L10-L10)	L41	L11	M	B	1977 ^b	1977 ^a	1977	1987	
L01(L10-L10)	L64	L11	?	B	1985 ^b	1985 ^a	1985	1985	1985
L01(L10-L10)	L77	L11	?	B	1987 ^b	1987 ^a	1987	1987	
L01(L10-L28)	L10	L12 ^a	M	J	1959 ^m	1959 ^g	1973	1987	
L01(L10-L28)	L28	F	A	≤ 1935 ^o	1924 ^f	1974	1987		
L01(L10-L28)	L32	L28	F	A	≤ 1950 ^o	1948 ^d	1973	1987	
L01(L10-L28)	L38	L32 ^d	M	J	1965 ^m	1965 ^g	1974	1987	
L01(L10-L28)	L22	L32	F	J	1971 ^e	1971 ^b	1974	1987	
L01(L10-L28)	L75	L22	?	B	1986 ^b	1986 ^a	1986	1987	
L01(L10-L28)	L44	L32	M	B	1974 ^b	1974 ^a	1974	1987	

Pod(Sub-MAT)	ID	Mom	Sex	Cat	Year of birth		Seen		
					Min.Age	Est.Age	First	Last	Died
L01(L10-L28)	L56	L32	?	B	1978 ^b	1978 ^a	1978	1981	1981
L01(L10-L28)	L69	L32	?	B	1984 ^b	1984 ^a	1984	1985	1985
L01(L10-L28)	L63	L32	?	B	1984 ^b	1984 ^a	1984	1987	
L01(L10-L15)	L15		F	A	≤ 1937 ^o	1930 ^f	1974	1981	1981
L01(L10-L15)	L13	L15	M	A	≤ 1952 ^p	≤ 1952 ⁱ	1973	1980	1980
L01(L10-L15)	L20	L15	M	J	1955 ^m	1955 ^g	1974	1982	1982
L01(L35-L35)	L35		F	A	≤ 1944 ^o	1942 ^d	1974	1987	
L01(L35-L35)	L01	L35	M	J	1959 ^m	1959 ^g	1974	1987	
L01(L35-L35)	L50	L35	M	J	1973 ^e	1973 ^b	1974	1987	
L01(L35-L35)	L54	L35	?	B	1977 ^b	1977 ^a	1977	1987	
L01(L35-L35)	L65	L35	?	B	1984 ^b	1984 ^a	1984	1987	
Unknown	B20		F	B	1977 ^b	1977 ^a	1977	1977	1977 ^c

Appendix Table B

Registry of all individuals in the northern resident community.

Pod(Sub-MAT)	ID	Mom	Sex	Cat	Year of birth		Seen		
					Min.Age	Est.Age	First	Last	Died
A01(A01-A01)	A01		F	A	≤ 1934 ^o	1927 ^d	1971	1974	1974
A01(A01-A01)	A36	A01	F	A	≤ 1949 ^o	1947 ^d	1972	1987	
A01(A01-A01)	A32	A36	M	J	1964 ^m	1964 ^g	1973	1987	
A01(A01-A01)	A44	A36 ^d	F	B	1973 ^b	1973 ^a	1973	1975	1975
A01(A01-A01)	A37	A36	M	B	1977 ^e	1977 ^b	1978	1987	
A01(A01-A01)	A46	A36	?	B	1982 ^b	1982 ^a	1982	1987	
A01(A01-A01)	A20	A01	M	J	1953 ^m	1953 ^g	1973	1987	
A01(A02-A02)	A02		F	A	≤ 1934 ^o	1927 ^d	1972	1987	
A01(A02-A02)	A30	A02	F	A	≤ 1949 ^o	1947 ^d	1973	1987	
A01(A02-A02)	A06	A30	M	J	1964 ^m	1964 ^g	1973	1987	
A01(A02-A02)	A38	A30	M	J	1970-1 ^c	1970-1 ^b	1973	1987	
A01(A02-A02)	A39	A30	M	B	1975 ^e	1975 ^b	1976	1987	
A01(A02-A02)	A40	A30	?	B	1981 ^b	1981 ^a	1981	1983	1983
A01(A02-A02)	A50	A30	F	B	1984 ^b	1984 ^a	1984	1987	
A01(A02-A02)	A03	A02	M	A	≤ 1952 ^p	≤ 1952 ⁱ	1973	1979	1979
A01(A12-A12)	A12		F	A	≤ 1943 ^o	1941 ^d	1973	1987	
A01(A12-A12)	A31	A12	M	J	1958 ^m	1958 ^g	1973	1987	
A01(A12-A12)	A33	A12	M	J	1971 ^e	1971 ^b	1973	1987	
A01(A12-A12)	A34	A12	F	B	1975 ^b	1975 ^a	1975	1987	
A04(A24-A04)	A10		F	A	≤ 1944 ^o	1941 ^d	1973	1983	1983
A04(A24-A04)	A24	A10	F	J	1967 ^e	1967 ^b	1973	1987	
A04(A24-A04)	A41	A24 ^d	?	B	1981 ^b	1981 ^a	1981	1981	1981 ^u
A04(A24-A04)	A45	A24	?	B	1983 ^b	1983 ^a	1983	1987	
A04(A24-A04)	A49	A24	?	B	1985 ^b	1985 ^a	1985	1986	1986
A04(A24-A04)	A19	A10	?	B	1973 ^b	1973 ^a	1973	1973	1973
A04(A24-A04)	A47	A10	?	B	1983 ^b	1983 ^a	1983	1983	1983
A04(A24-A04)	A04		M	A	≤ 1952 ^p	≤ 1952 ⁱ	1973	1984	1984
A04(A11-A11)	A11	A10	F	A	≤ 1959 ^o	1958 ^d	1973	1987	
A04(A11-A11)	A35	A11	F	B	1974 ^b	1974 ^a	1974	1987	
A04(A11-A11)	A52	A35	?	B	1987 ^b	1987 ^a	1987	1987	
A04(A11-A11)	A13	A11	M	B	1978 ^b	1978 ^a	1978	1987	
A04(A11-A11)	A48	A11	?	B	1983 ^b	1983 ^a	1983	1987	
A05(A14-A14)	A14		F	A	≤ 1949 ^o	1947 ^d	1968	1987	
A05(A14-A14)	A17	A14	?	-	1964 ^e	-	1968	1968	1969 ^c
A05(A14-A14)	A18	A14	F	-	1969 ^e	-	1969	1969	1969 ^c
A05(A14-A14)	A25	A14	F	J	1971-2 ^e	1971-2 ^b	1973	1987	
A05(A14-A14)	A51	A25	?	B	1986 ^b	1986 ^a	1986	1987	
A05(A14-A14)	A15	A14	M	B	1979 ^b	1979 ^a	1979	1987	
A05(A14-A07)	A07		F	A	≤ 1934 ^o	1927 ^f	1969	1977	1977
A05(A14-A07)	A23	A07	F	A	≤ 1949 ^o	1947 ^d	1969	1987	
A05(A14-A07)	A16	A23	F	-	1964 ^e	-	1969	1969	1969 ^c
A05(A14-A07)	A21	A23	?	J	1967 ^e	1967 ^b	1973	1973	
A05(A14-A07)	A27	A23	M	J	1971-2 ^e	1971-2 ^b	1973	1987	
A05(A14-A07)	A29	A23	?	B	1977 ^b	1977 ^a	1977	1980	1980
A05(A14-A07)	A43	A23	?	B	1981 ^b	1981 ^a	1981	1987	
A05(A05-A09)	A09		F	A	≤ 1942 ^o	1937 ^f	1973	1987	
A05(A05-A09)	A05	A09	M	J	1957 ^m	1957 ^g	1969	1987	
A05(A05-A09)	A26	A09	M	J	1971-2 ^e	1971-2 ^b	1973	1987	
A05(A05-A08)	A08	A09	F	A	≤ 1959 ^o	1953 ^f	1969	1987	
A05(A05-A08)	A28	A08	F	B	1974 ^b	1974 ^a	1974	1987	
A05(A05-A08)	A42	A08	F	B	1980 ^b	1980 ^a	1980	1987	
B01(B01-B01)	B11		F	A	≤ 1934 ^o	1927 ^d	1973	1973	1973
B01(B01-B01)	B07	B11	F	A	≤ 1949 ^o	1947 ^d	1973	1987	
B01(B01-B01)	B08	B07	M	J	1964 ^m	1964 ^g	1973	1987	
B01(B01-B01)	B10	B07	M	B	1979 ^b	1979 ^a	1979	1987	
B01(B01-B01)	B12	B07	?	B	1984 ^b	1984 ^a	1984	1987	
B01(B01-B01)	B13	B07 ^d	?	B	1987 ^b	1987 ^a	1987	1987	
B01(B01-B01)	B01	B11	M	A	≤ 1951 ^p	≤ 1951 ⁱ	1972	1987	

Pod(Sub-MAT)	ID	Mom	Sex	Cat	Year of birth		Seen		
					Min.Age	Est.Age	First	Last	Died
B01(B01-B01)	B03	B11	M	J	1958 ^m	1958 ^g	1973	1982	1982
B01(B01-B01)	B05	B11	M	J	1963 ^m	1963 ^g	1973	1985	1985
B01(B01-B01)	B06	B11 ^d	M	B	1973 ^b	1973 ^a	1973	1987	
B01(B01-B01)	B02		M	A	≤ 1952 ^o	≤ 1952 ⁱ	1973	1987	
C01(C01-C01)	C03		M	A	≤ 1952 ^p	≤ 1952 ⁱ	1973	1987	
C01(C01-C01)	C04		F	A	≤ 1941-2 ^o	1937 ^d	1973	1982	1982-4
C01(C01-C01)	C01	C04 ^a	M	A	≤ 1951 ^p	≤ 1951 ⁱ	1972	1980	1980-1
C01(C01-C01)	C06	C04	F	A	≤ 1956-7 ^o	1955 ^d	1973	1987	
C01(C01-C01)	C09	C06	M	J	1971-2 ^e	1971-2 ^b	1973	1987	
C01(C01-C01)	C08	C06	F	B	1975 ^b	1975 ^a	1975	1987	
C01(C01-C01)	C12	C06	?	B	1979 ^e	1979 ^b	1980	1987	1987
C01(C01-C01)	C14	C06	?	B	1985 ^b	1985 ^a	1985	1987	
C01(C01-C01)	C07		M	A	≤ 1951 ^p	≤ 1951 ⁱ	1972	1984	1984
C01(C05-C05)	C05		F	A	≤ 1930 ^o	1924 ^d	1965	1987	
C01(C05-C05)	C11	C05	M	-	1945 ^e	-	1965	1965	1965 ^c
C01(C05-C05)	C02	C05	M	J	1957 ^m	1957 ^g	1965	1986	1986
C01(C05-C05)	C15	C05	?	-	1964 ^e	-	1965	1965	1965-73
C01(C05-C05)	C10	C05	F	J	1971-2 ^e	1971-2 ^b	1973	1987	
C01(C05-C05)	C13	C10	?	B	1985 ^b	1985 ^a	1985	1987	
D01(D07-D07)	D07		F	A	≤ 1943 ^o	1941 ^d	1973	1987	
D01(D07-D07)	D04	D07	M	J	1958 ^m	1958 ^g	1973	1984	1984
D01(D07-D07)	D10	D07	?	B	1978 ^b	1978 ^a	1978	1987	
D01(D07-D07)	D13	D07	?	B	1984 ^b	1984 ^a	1984	1987	
D01(D07-D08)	D08	D07	F	J	1967 ^m	1967 ^g	1973	1987	
D01(D07-D08)	D12	D08	?	B	1982 ^b	1982 ^a	1982	1987	
D01(D07-D08)	D16	D08	?	B	1987 ^b	1987 ^a	1987	1987	
D01(D07-D08)	D09	D07	F	J	1971-2 ^e	1971-2 ^b	1973	1987	
D01(D07-D08)	D15	D09	?	B	1987 ^b	1987 ^a	1987	1987	
D01(D01-D01)	D03		F	A	≤ 1941 ^u	1939 ^d	1973	1987	
D01(D01-D01)	D02	D03	M	J	1956 ^m	1956 ^g	1973	1982	1982
D01(D01-D01)	D05	D03	M	J	1963 ^m	1963 ^g	1973	1987	
D01(D01-D01)	D11	D03	F	B	1975 ^b	1975 ^a	1975	1987	
D01(D01-D01)	D14	D11	?	B	1987 ^b	1987 ^a	1987	1987	
D01(D01-D01)	D01		M	A	≤ 1952 ^p	≤ 1952 ⁱ	1973	1981	1981
G01(G01-G01)	G01		M	A	≤ 1952 ^p	≤ 1952 ⁱ	1973	1978	1978-80
G01(G01-G01)	G03		F	A	≤ 1957 ^o	1956 ^d	1974	1987	
G01(G01-G01)	G20	G03	F	J	1972 ^e	1972 ^b	1974	1987	
G01(G01-G01)	G37	G20	?	B	1984 ^b	1984 ^{a</}			

Pod(Sub-MAT)	ID	Mom	Sex	Cat	Year of birth		Seen		
					Min.Age	Est.Age	First	Last	Died
G01(G04-G04)	G06	G04	M	J	1965 ^m	1965 ^b	1973	1987	
G01(G04-G04)	G26	G04	M	J	1970-1 ^c	1970-1 ^b	1973	1987	
G12(G12-G02)	G02		F	A	≤ 1962 ^o	1961 ^d	1973	1986	
G12(G12-G02)	G34	G02	?	B	1977 ^c	1977 ^b	1982	1985	
G12(G12-G02)	G28	G02	?	B	1981 ^b	1981 ^a	1981	1986	
G12(G12-G02)	G36	G02	?	B	1985 ^b	1985 ^b	1985	1986	
G12(G12-G02)	G12		F	A	≤ 1956 ^o	1955 ^d	1968	1987	
G12(G12-G12)	G08	G12	F	J	1971 ^c	1971 ^b	1973	1987	
G12(G12-G12)	G35	G08	?	B	1985 ^b	1985 ^a	1985	1987	
G12(G12-G12)	G27	G12	F	J	1973-4 ^e	1973-4 ^b	1974	1987	
G12(G12-G12)	G41	G27 ^d	?	B	1987 ^b	1987 ^a	1987	1987	
G12(G12-G12)	G33	G12	?	B	1978-9 ^e	1978-9 ^b	1981	1987	
G12(G12-G12)	G42	G12 ^d	?	B	1986 ^e	1986 ^b	1987	1987	
H01(H01-H01)	H06		F	A	≤ 1944-5 ^o	1942 ^d	1975	1987	
H01(H01-H01)	H03	H06	F	A	≤ 1959-60 ^o	1959 ^d	1974	1987	
H01(H01-H01)	H04	H03	M	J	1974-5 ^e	1974-5 ^b	1975	1987	
H01(H01-H01)	H07	H03	M	B	1981 ^b	1981 ^a	1981	1987	
H01(H01-H01)	H08	H03	?	B	1986 ^b	1986 ^a	1986	1987	
H01(H01-H01)	H02	H06	M	J	1965 ^m	1965 ^b	1974	1987	
H01(H01-H01)	H05	H06	F	J	1973 ^e	1973 ^b	1975	1987	
H01(H01-H01)	H01		M	A	≤ 1952 ^p	≤ 1952 ⁱ	1973	1982	1982
I01(I01-I01)	I01		F	A	≤ 1953 ^o	1952 ^d	1973	1986	
I01(I01-I01)	I19	I01	F	J	1968 ^m	1968 ^c	1975	1986	
I01(I01-I01)	I54	I19	?	B	1983 ^e	1983 ^b	1986	1986	
I01(I01-I01)	I56	I19	?	B	1986 ^b	1986 ^a	1986	1986	
I01(I01-I01)	I23	I01	M	J	1973-4 ^e	1973-4 ^b	1975	1986	
I01(I01-I01)	I40	I01	?	B	1980 ^b	1980 ^a	1980	1986	
I01(I01-I01)	I03		M	A	≤ 1954 ^p	≤ 1954 ⁱ	1975	1986	
I02(I02-I02)	I02		F	A	≤ 1939 ^o	1936 ^d	1975	1987	
I02(I02-I02)	I14	I02	M	A	≤ 1954 ^p	≤ 1954 ⁱ	1975	1987	
I02(I02-I02)	I05	I02	M	A	≤ 1954 ^p	≤ 1954 ⁱ	1975	1987	
I02(I02-I02)	I08	I02	M	J	1964 ^m	1964 ^b	1975	1987	
I02(I02-I02)	I28	I02	M	J	1974 ^c	1974 ^b	1975	1987	
I02(I02-I22)	I22	I02	F	J	1965 ^m	1965 ^c	1975	1987	
I02(I02-I22)	I39	I22	?	B	1980 ^e	1980 ^b	1981	1987	
I02(I02-I22)	I55	I22	?	B	1987 ^b	1987 ^a	1987	1987	
I11(I11-I11)	I11		F	A	≤ 1955 ^o	1954 ^d	1968	1987	
I11(I11-I11)	I12	I11	F	J	1970 ^m	1970 ^c	1975	1987	
I11(I11-I11)	I47	I12	?	B	1985 ^b	1985 ^a	1985	1987	
I11(I11-I11)	I13	I11	?	J	1974 ^c	1974 ^b	1975	1987	
I11(I11-I11)	I37	I11	?	B	1979 ^e	1979 ^b	1980	1987	
I11(I11-I11)	I42	I11	?	B	1983 ^b	1983 ^a	1983	1987	
I11(I15-I15)	I10		M	A	≤ 1947 ^p	≤ 1947 ⁱ	1968	1975	1975-7
I11(I15-I15)	I15		F	A	≤ 1953 ^o	1952 ^d	1975	1987	
I11(I15-I15)	I16	I15	F	J	1968 ^m	1968 ^c	1975	1987	
I11(I15-I15)	I43	I16	?	B	1983 ^b	1983 ^a	1983	1987	
I11(I15-I15)	I51	I16	?	B	1986 ^b	1986 ^a	1986	1987	
I11(I15-I15)	I27	I15	?	J	1974 ^e	1974 ^b	1975	1987	
I11(I15-I15)	I04	I15	?	B	1980 ^b	1980 ^a	1980	1987	
I11(I15-I15)	I41	I15	?	B	1980 ^e	1980 ^b	1981	1987	
I11(I15-I15)	I44	I15	?	B	1985 ^b	1985 ^a	1985	1987	
I18(I18-I18)	I18		F	A	≤ 1949 ^o	1947 ^d	1975	1986	
I18(I18-I18)	I20	I18	F	A	≤ 1964 ^o	1964 ^d	1975	1986	
I18(I18-I18)	I21	I20	?	B	1979 ^b	1979 ^a	1979	1986	
I18(I18-I18)	I52	I20	?	B	1986 ^b	1986 ^a	1986	1986	
I18(I18-I18)	I07	I18	F	J	1968 ^m	1968 ^c	1975	1986	
I18(I18-I18)	I48	I07	?	B	1983 ^e	1983 ^b	1985	1986	
I18(I18-I18)	I49	I18	?	B	1976 ^e	1976 ^b	1979	1986	
I18(I18-I18)	I24	I18	?	B	1980 ^b	1980 ^a	1980	1986	
I18(I18-I18)	I53	I18	?	B	1986 ^b	1986 ^a	1986	1986	
I18(I17-I17)	I17		F	A	≤ 1960 ^o	1959 ^d	1975	1986	
I18(I17-I17)	I26	I17	?	B	1975 ^b	1975 ^a	1975	1986	
I18(I17-I17)	I38	I17	?	B	1979-80 ^e	1979-80 ^b	1980	1986	
I18(I17-I17)	I50	I17	?	B	1982-3 ^e	1982-3 ^b	1985	1986	
I31(I31-I31)	I31		F	A	≤ 1948 ^o	1946 ^d	1968	1987	
I31(I31-I31)	I32	I31	M	J	1963 ^m	1963 ^b	1975	1987	
I31(I31-I31)	I33	I31	F	J	1970 ^m	1970 ^c	1975	1987	
I31(I31-I31)	I45	I33	?	B	1985 ^b	1985 ^a	1985	1987	
I31(I31-I31)	I35	I31	?	J	1974 ^e	1974 ^b	1975	1987	
I31(I31-I31)	I36	I31	?	B	1980 ^e	1980 ^b	1981	1987	
I31(I31-I31)	I46	I31	?	B	1985 ^b	1985 ^a	1985	1987	
R01(R05-R05)	R05		F	A	≤ 1950 ^o	1948 ^d	1975	1987	
R01(R05-R05)	R19	R05	?	B	1975 ^b	1975 ^a	1975	1986	1986
R01(R05-R05)	R20	R05	?	B	1979 ^e	1979 ^b	1982	1987	
R01(R05-R05)	R24	R05	?	B	1987 ^b	1987 ^a	1987	1987	
R01(R05-R07)	R17		F	A	1965 ^e	1965 ^b	1975	1987	
R01(R05-R05)	R23	R17	?	B	1985 ^b	1985 ^a	1985	1987	
R01(R05-R18)	R04	R05 ^d	F	J	1965 ^e	1965 ^b	1975	1987	
R01(R05-R18)	R22	R04	?	B	1984 ^e	1984 ^b	1985	1987	
R01(R05-R18)	R18	R05	F	J	1967 ^m	1967 ^c	1975	1987	
R01(R05-R18)	R21	R18	M	B	1982 ^b	1982 ^a	1982	1987	
R01(R05-R18)	R25	R18	?	B	1987 ^b	1987 ^a	1987	1987	
R01(R01-R01)	R09		F	A	≤ 1931 ^o	1923 ^d	1975	1987	
R01(R01-R01)	R07	R09 ^a	F	A	≤ 1946 ^o	1944 ^d	1975	1987	
R01(R01-R01)	R08	R07	M	J	1961 ^m	1961 ^b	1975	1982	1982
R01(R01-R01)	R11	R07	?	J	1973 ^e	1973 ^b	1975	1975	1975-80
R01(R01-R01)	R13	R07	?	B	1979 ^e	1979 ^b	1981	1987	
R01(R01-R01)	R01	R09	M	A	≤ 1954 ^p	≤ 1954 ⁱ	1975	1987	
R01(R01-R01)	R10	R09	M	J	1956 ^m	1956 ^b	1975	1975	1975-8
R01(R01-R02)	R02		F	A	≤ 1941 ^o	1938 ^d	1975	1987	
R01(R01-R02)	R03	R02	M	J	1956 ^m	1956 ^b	1975	1987	
R01(R01-R02)	R12	R02	M	J	1966 ^m	1966 ^b	1975	1987	
R01(R01-R02)	R06		M	A	≤ 1954 ^p	≤ 1954 ⁱ	1975	1987	
R01(R01-R14)	R14		M	A	≤ 1954 ^p	≤ 1954 ⁱ	1975	1987	
R01(R01-R14)	R15		M	J	1963 ^m	1963 ^b	1975	1987	
W01(W01)	W03		F	A	≤ 1943 ^o	1940 ^d	1979	1987	
W01(W01)	W01	W03	M	A	≤ 1958 ^p	≤ 1958 ⁱ	1979	1983	1983
W01(W01)	W02	W03	M	J	1960 ^m	1960 ^b	1979	1987	
W01(W01)	W05	W03	M	J	1974 ^e	1974 ^b	1979	1987	
Unknown	B04		M	J	1962 ^e	1962 ^b	1973	1973	1973

[APPENDIX LEGENDS]

Cole's association index (CAI) dendrograms showing intra-pod (matrilial) groups (top); matrix of CAI values (middle) and genealogical trees (bottom) for all years pooled. The alpha-numeric codes above each intra-pod group represent their names and the height of the bar the level at which the group links to another intra-pod group. All adult females are underlined in the CAI matrices. CAI values for individuals that were included in the dendrograms, but not in the matrices, are indicated by x's in the matrices. Solid lines in the genealogical trees denote positive genealogies, dashed lines highly probable genealogies and dotted lines probable genealogies. The sexes of individuals that matured prior to or during the study are given in the genealogical trees. The oldest offspring are usually positioned to the left. The placement order of the Appendix Figs is the same as that given in text Figs 4-5.

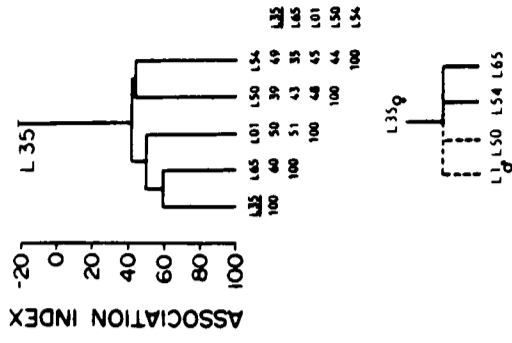

Fig. D. Genealogy of subpod L35.

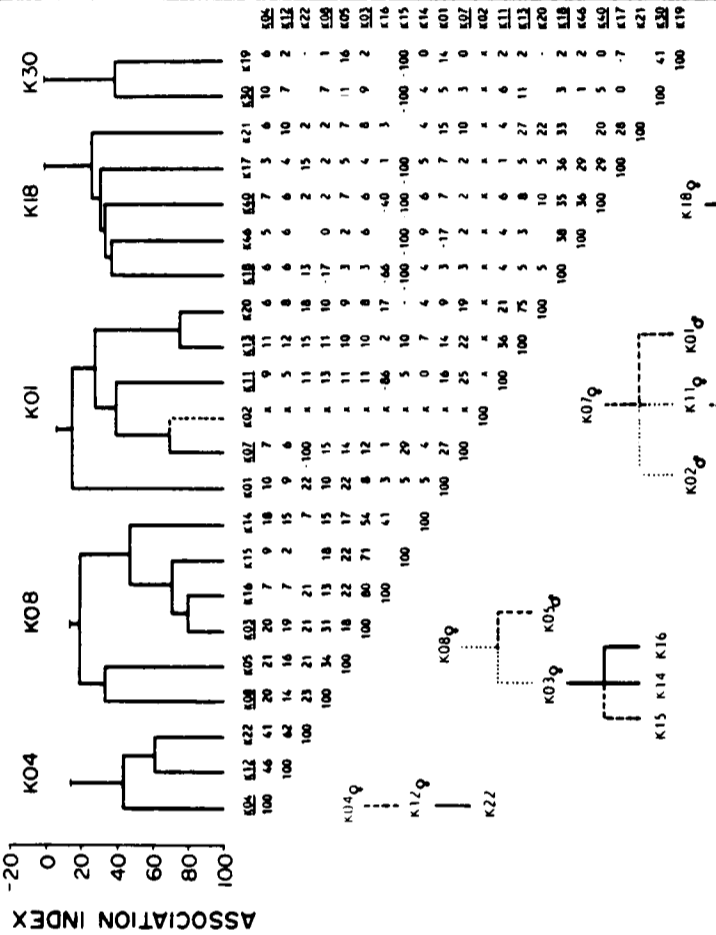

Fig. B. Genealogy of pod K01.

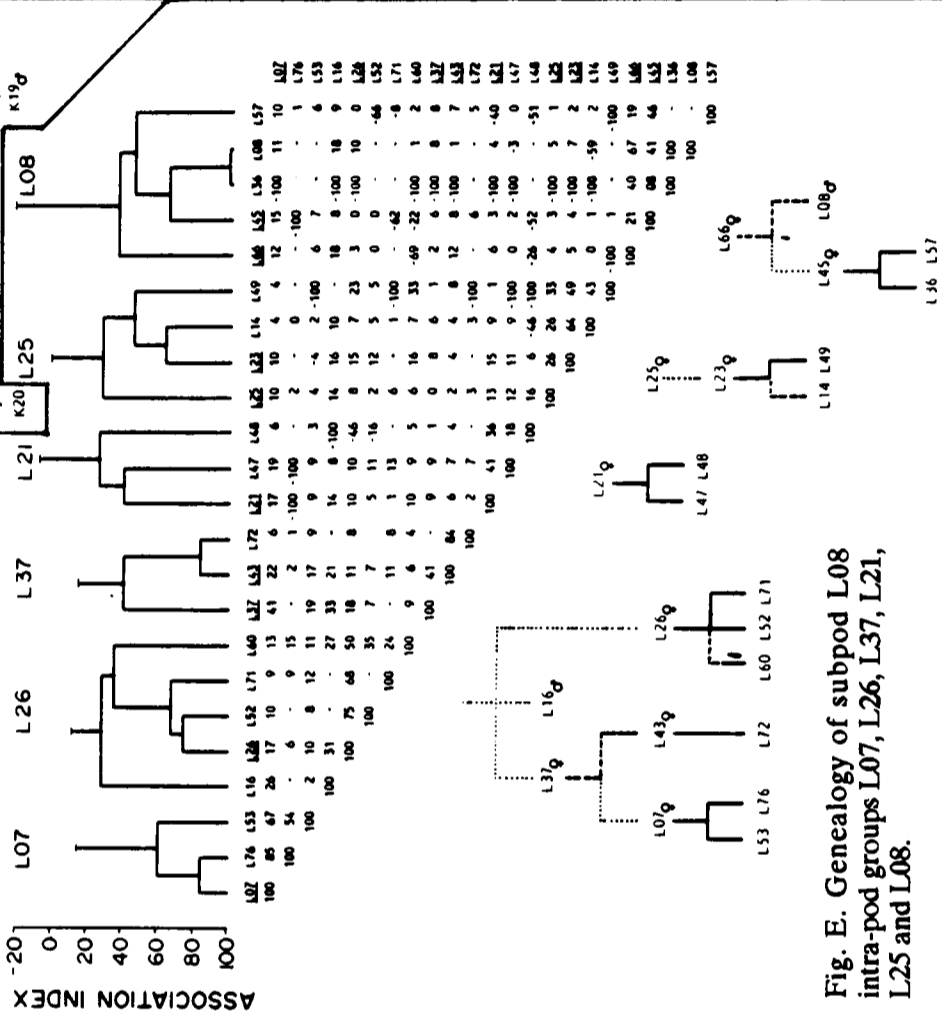

Fig. E. Genealogy of subpod L08 intra-pod groups L07, L26, L37, L21, L25 and L08.

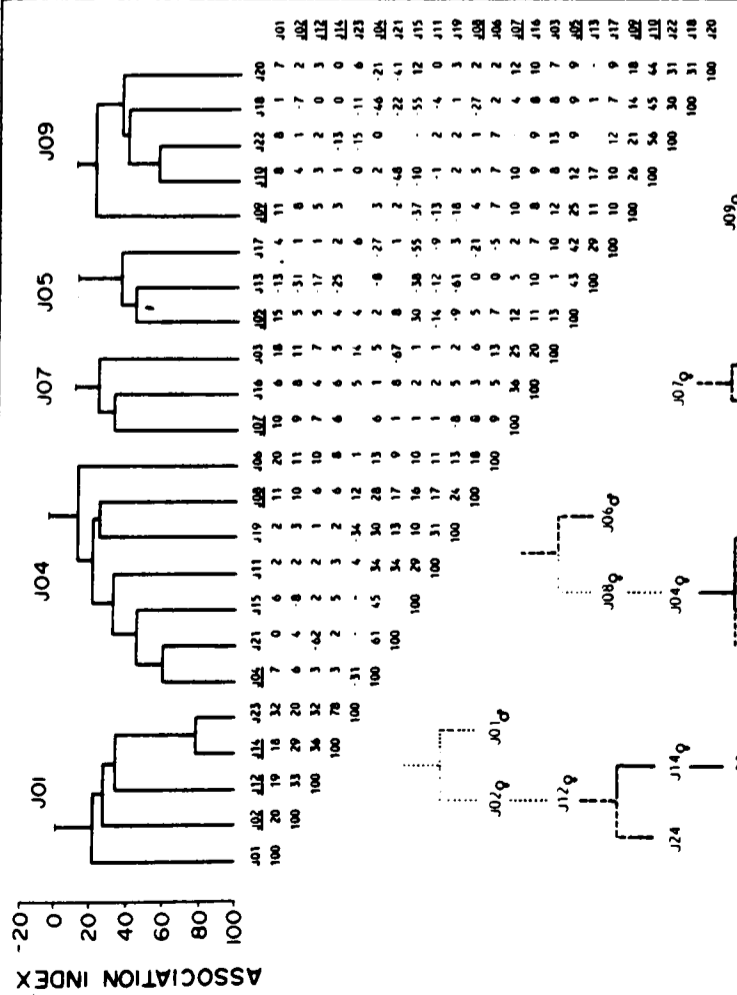

Fig. A. Genealogy of pod J01.

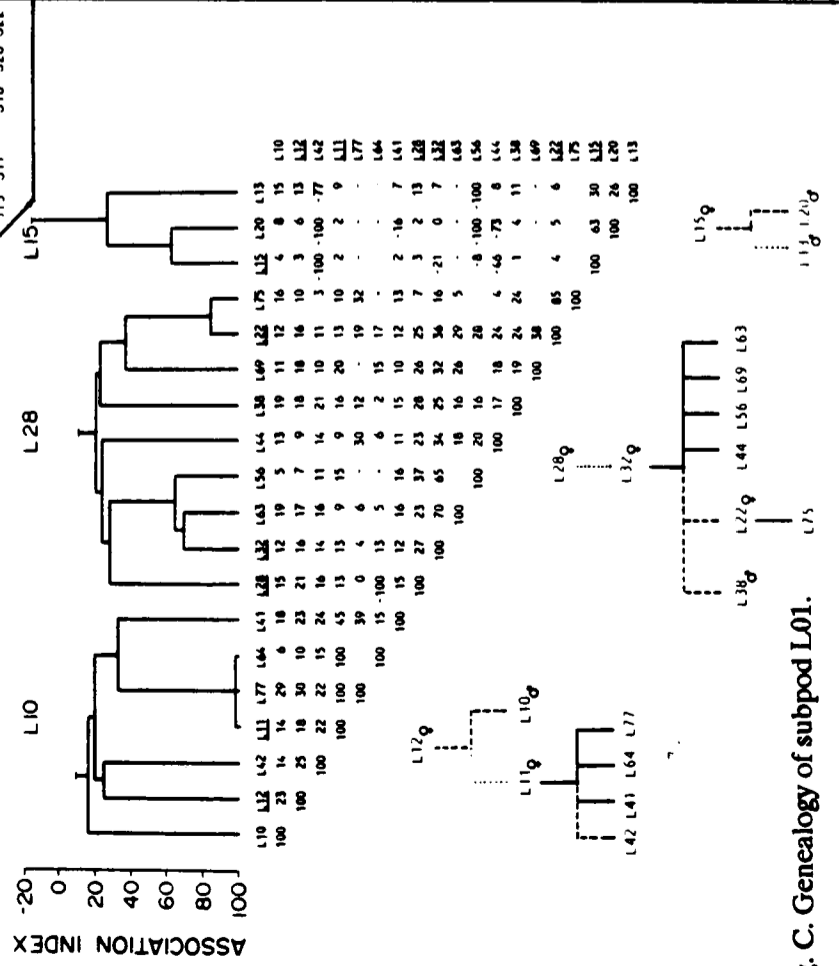

Fig. C. Genealogy of subpod L01.

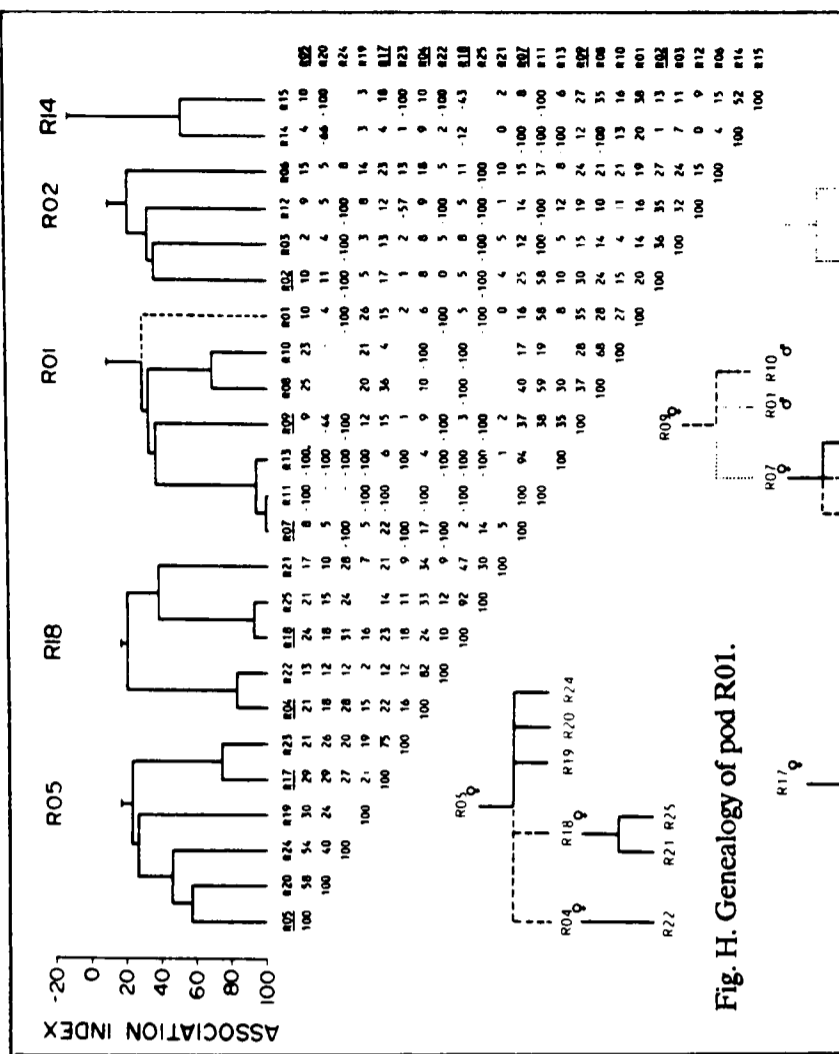

Fig. H. Genealogy of pod R01.

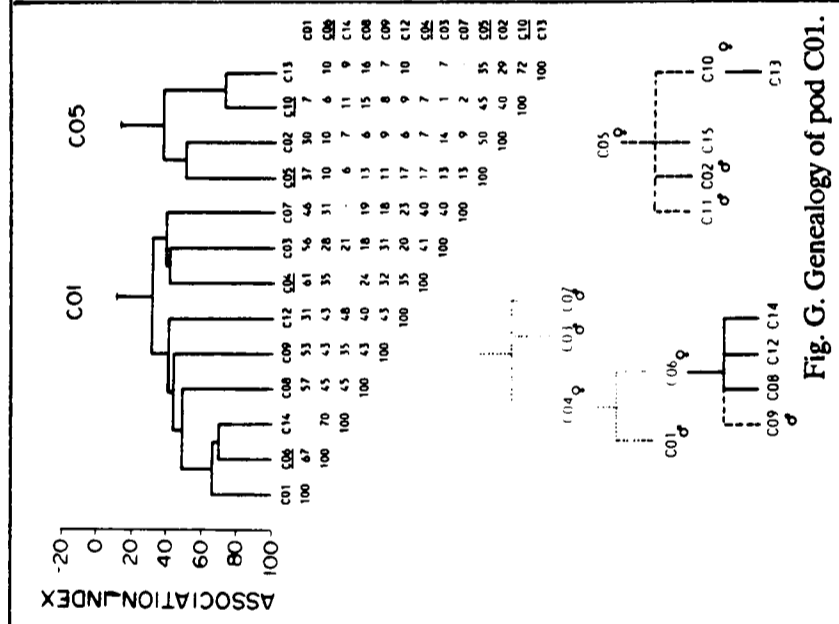

Fig. G. Genealogy of pod C01.

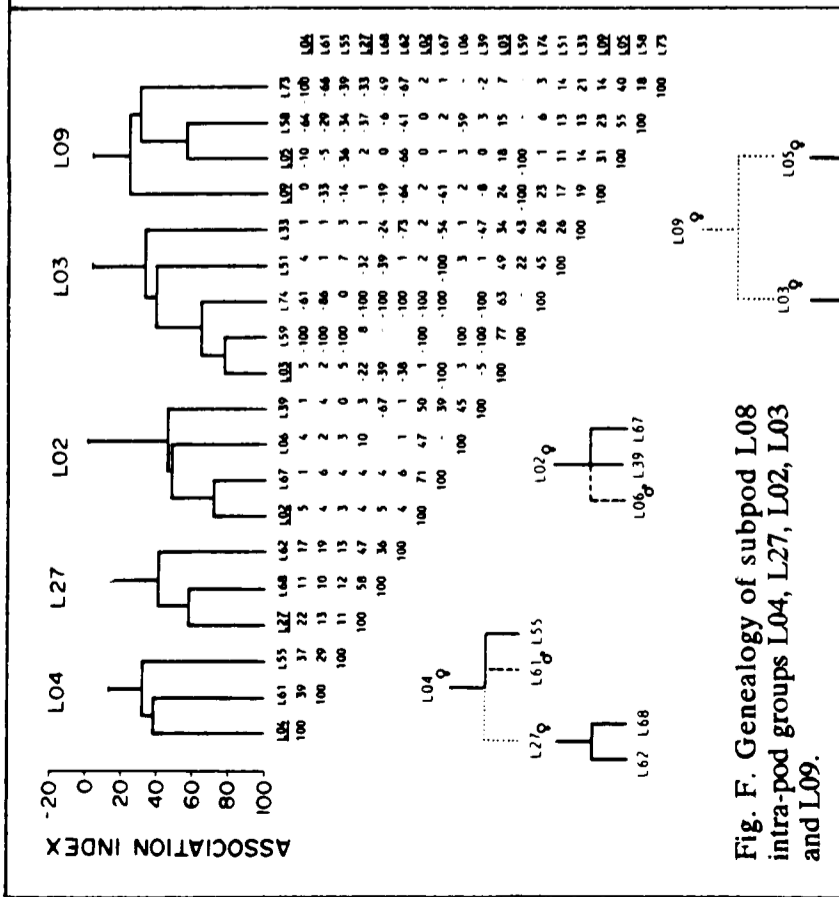

Fig. F. Genealogy of subpod L08 intra-pod groups L04, L27, L02, L03 and L09.

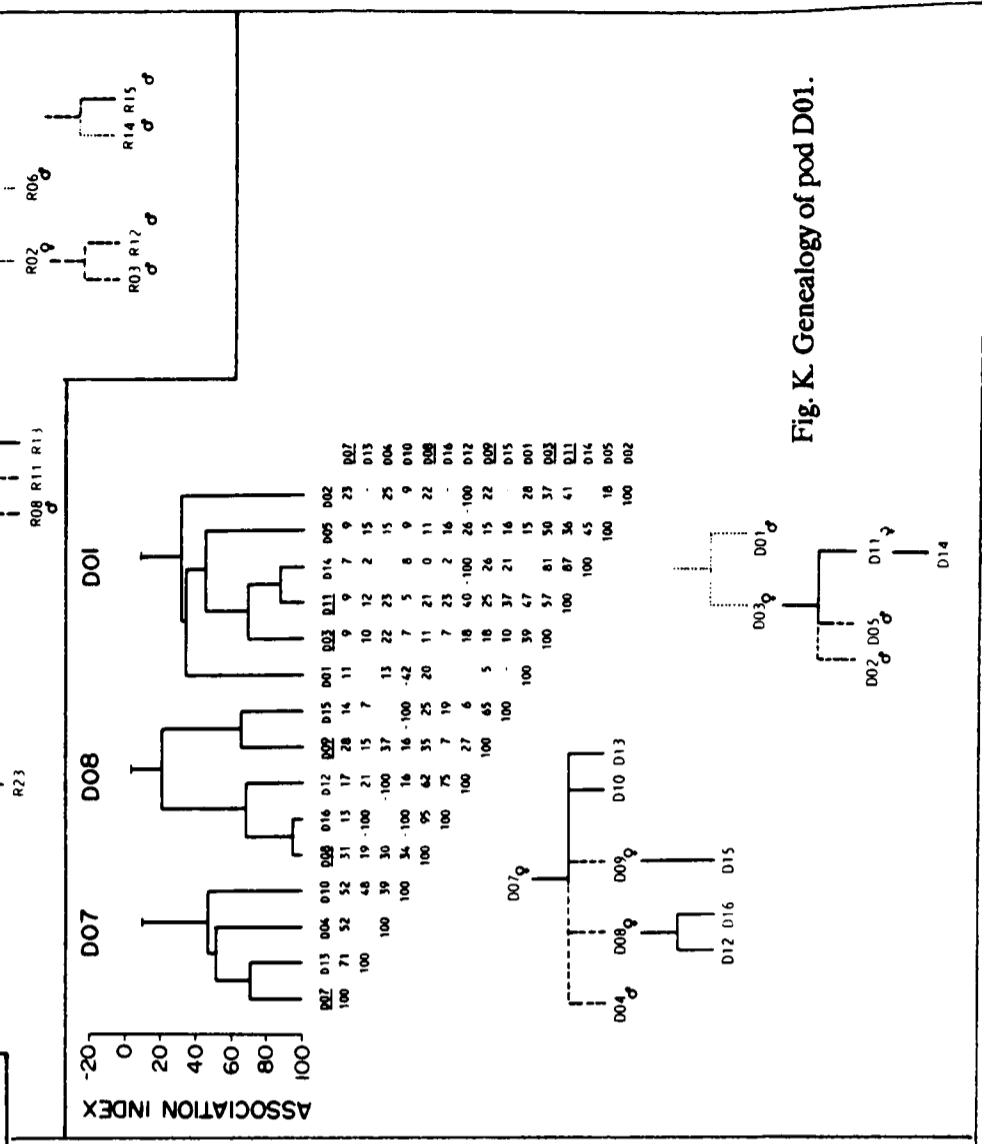

Fig. K. Genealogy of pod D01.

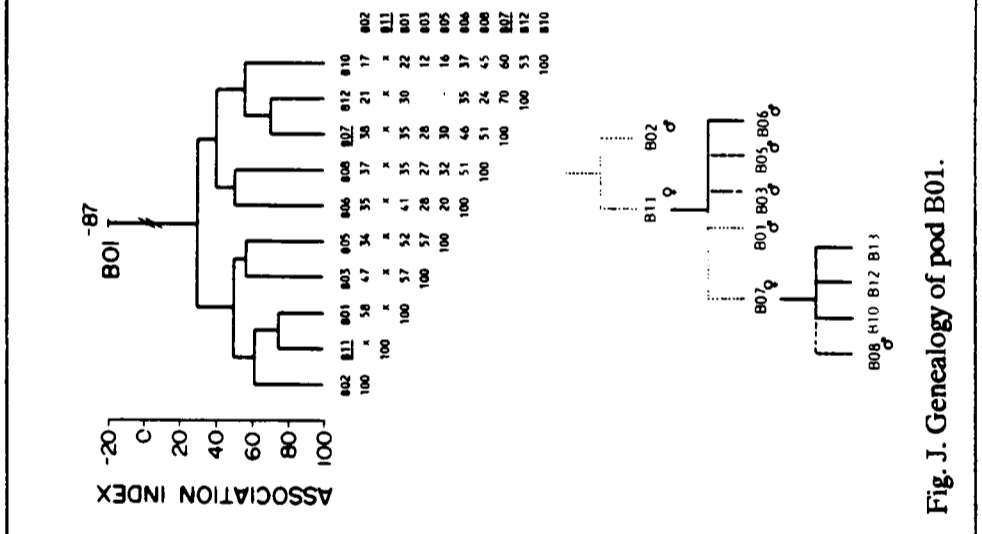

Fig. J. Genealogy of pod B01.

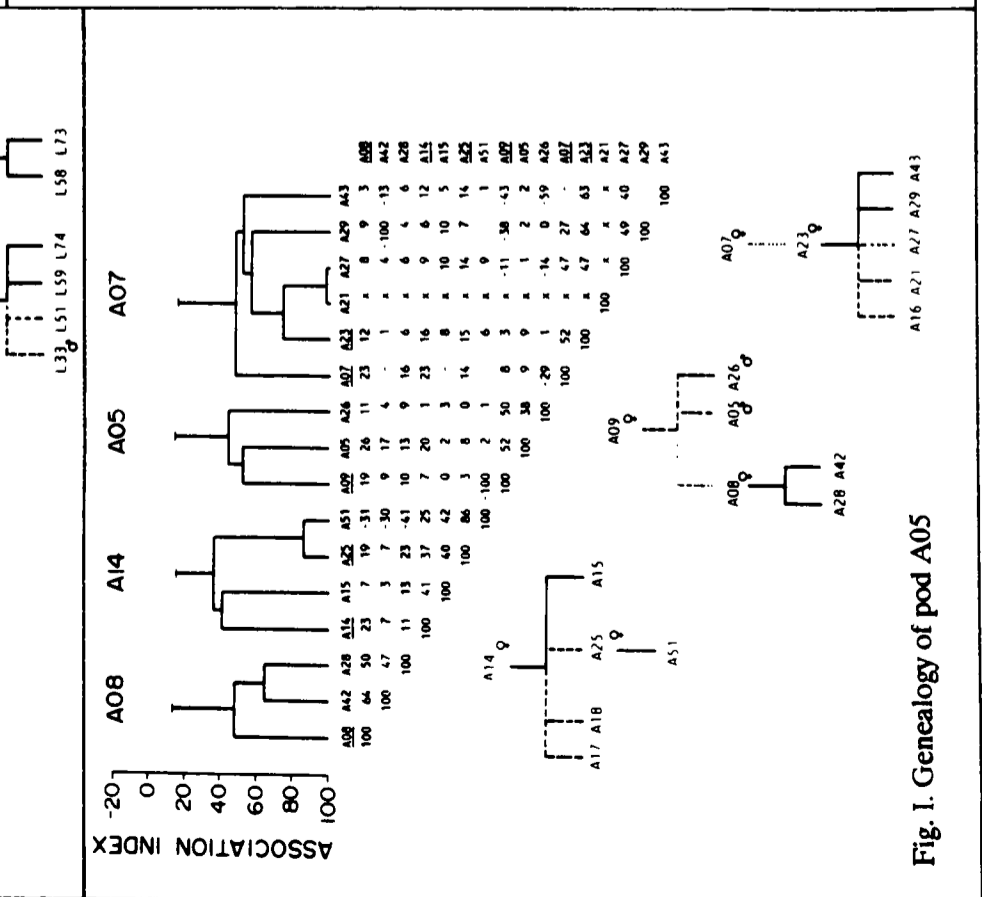
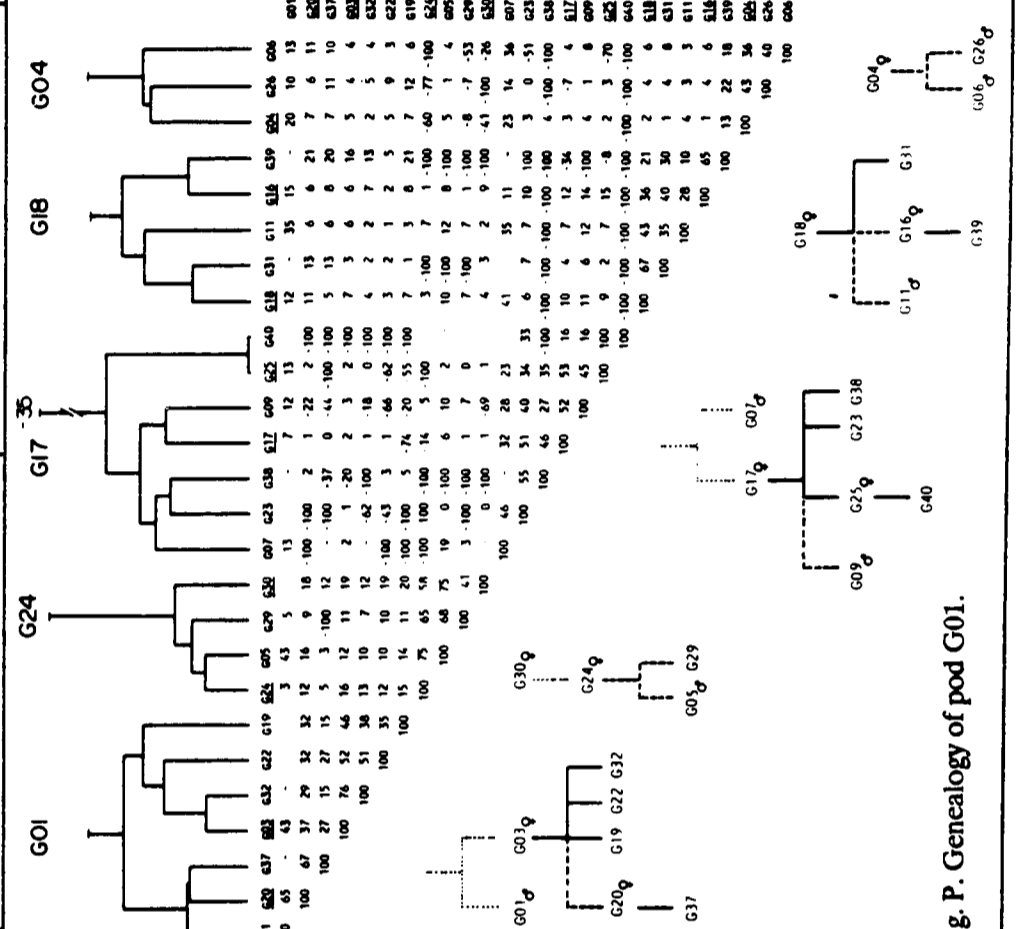
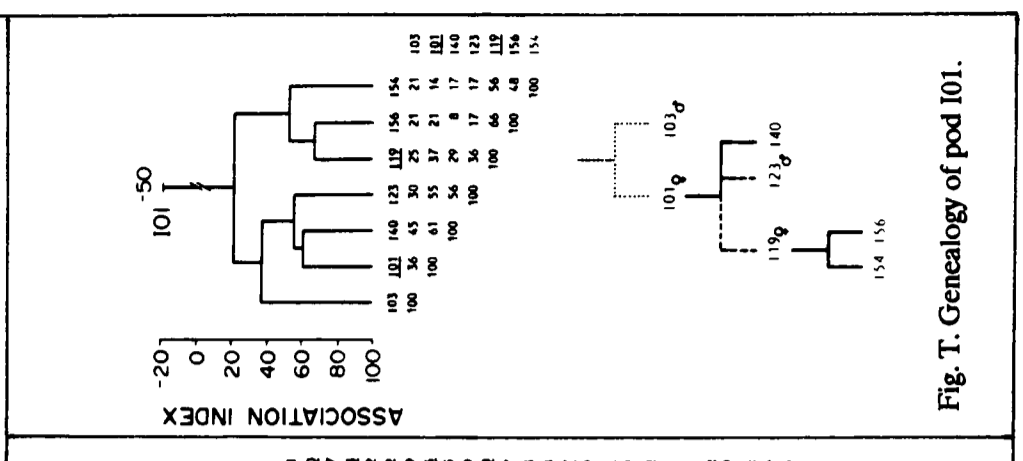
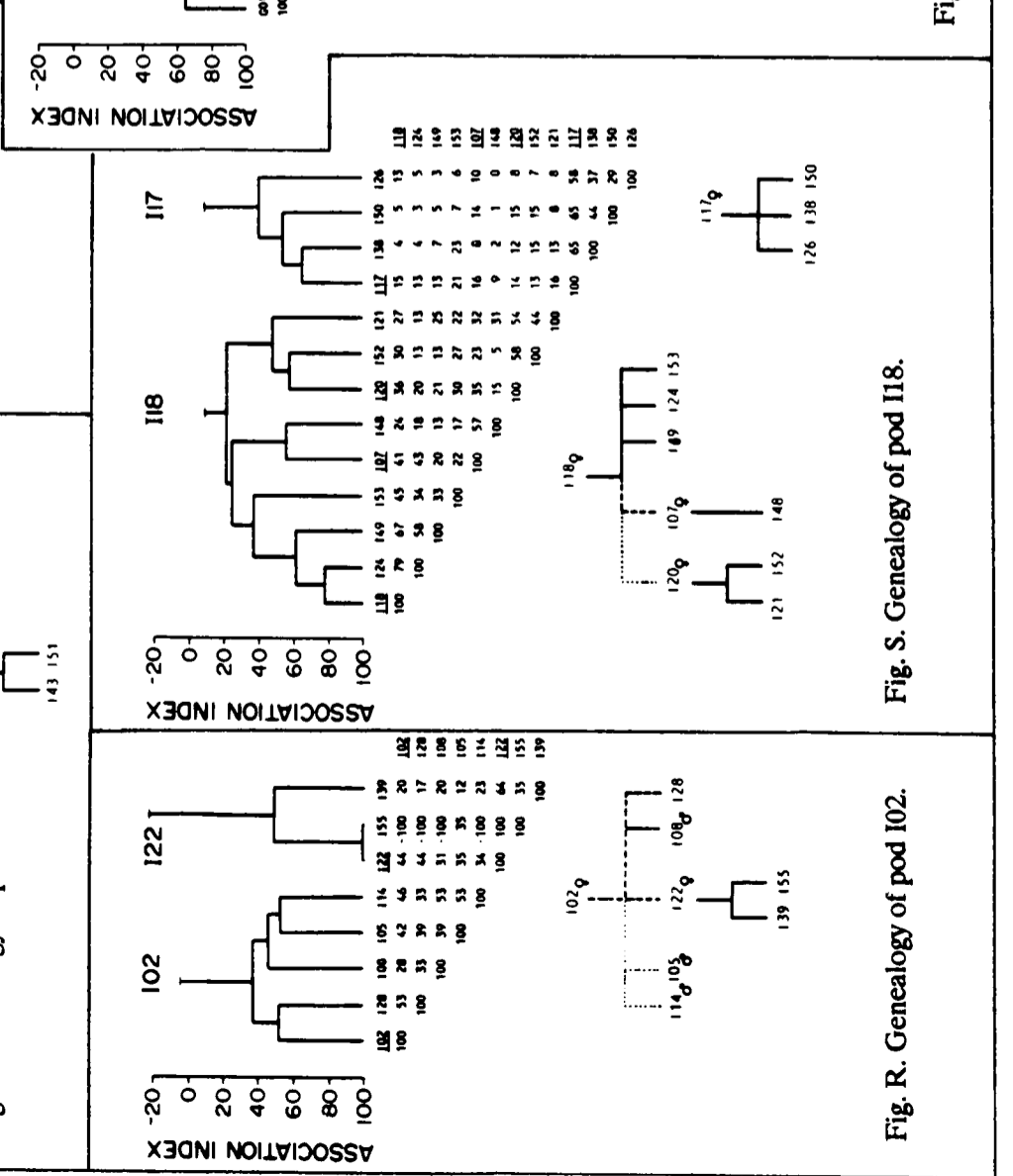
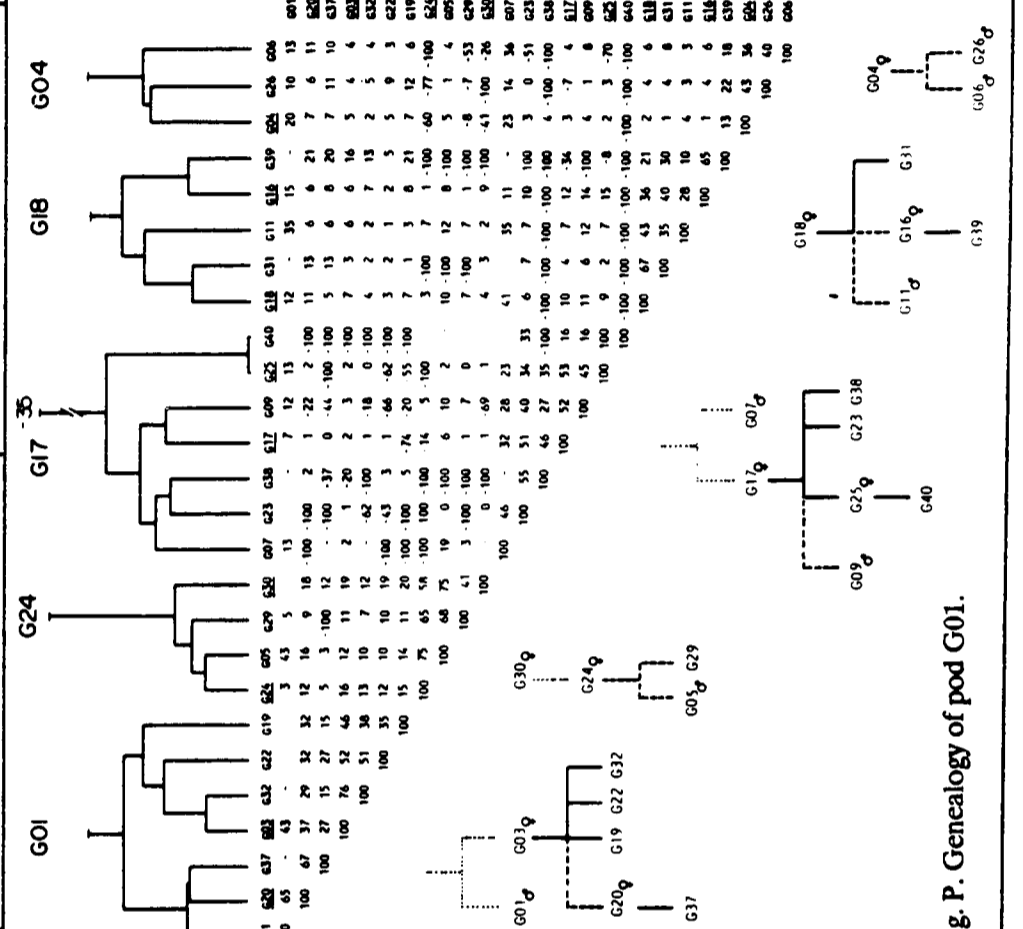
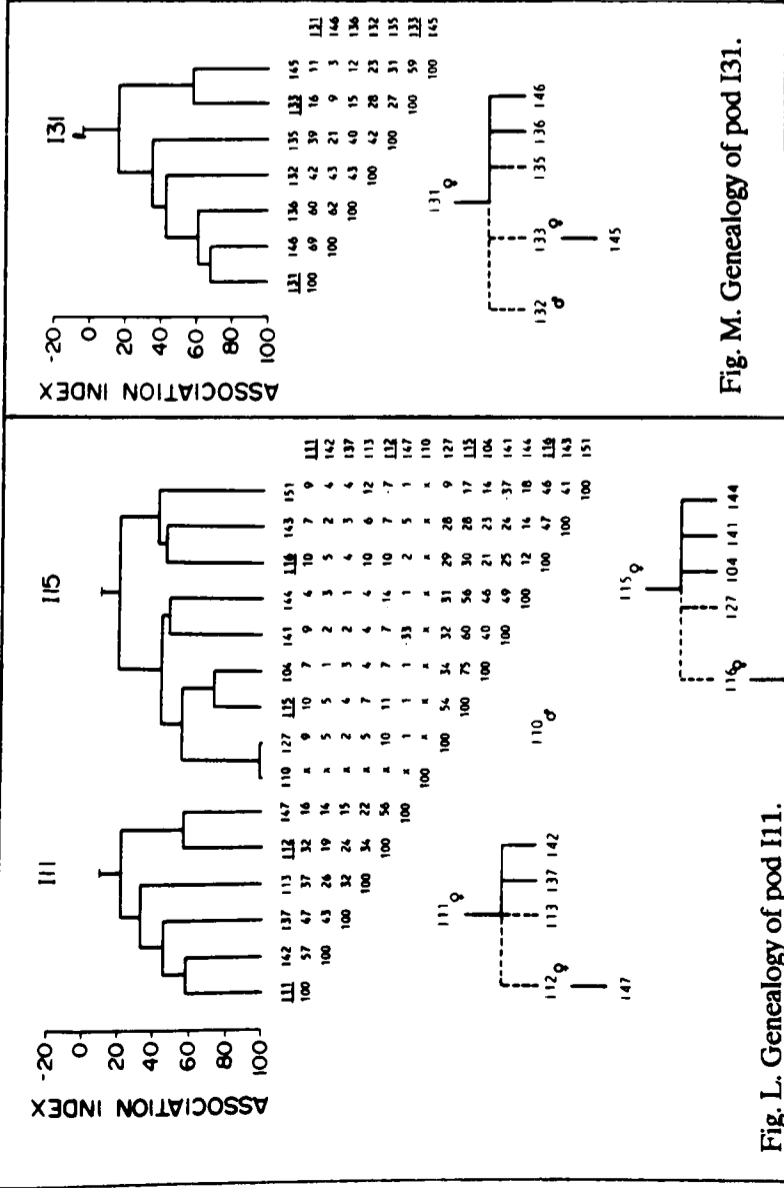
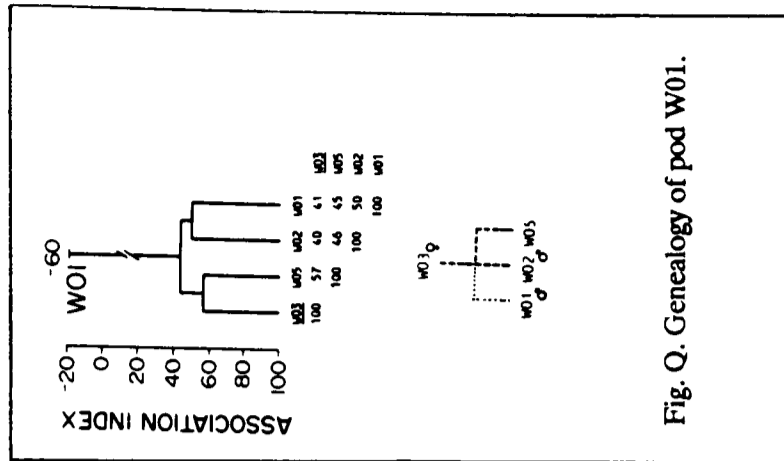
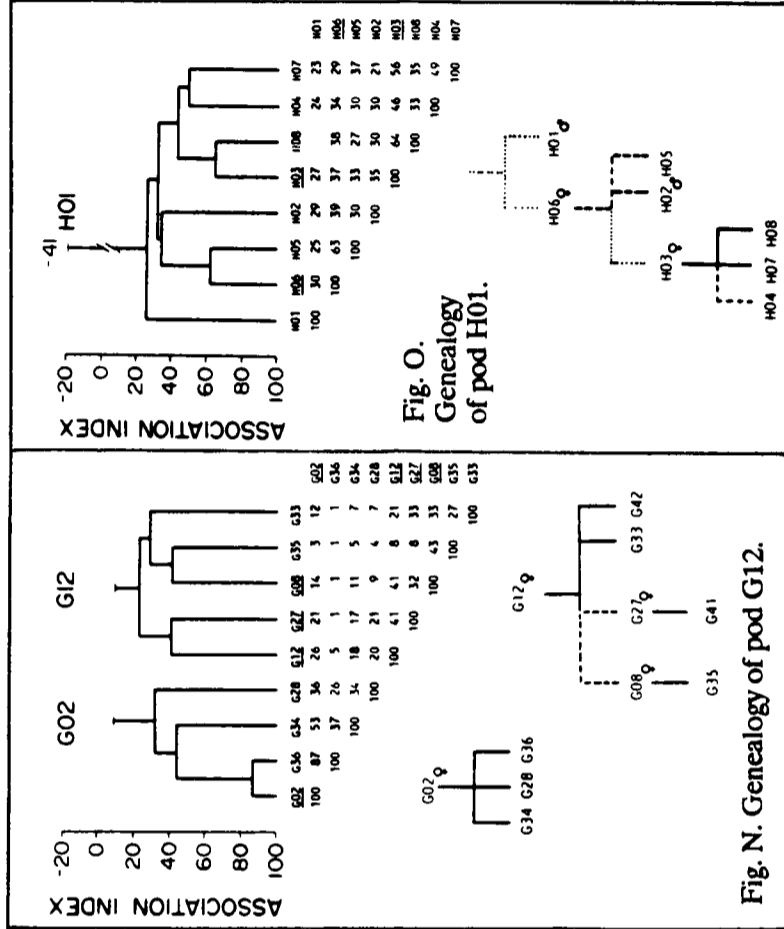
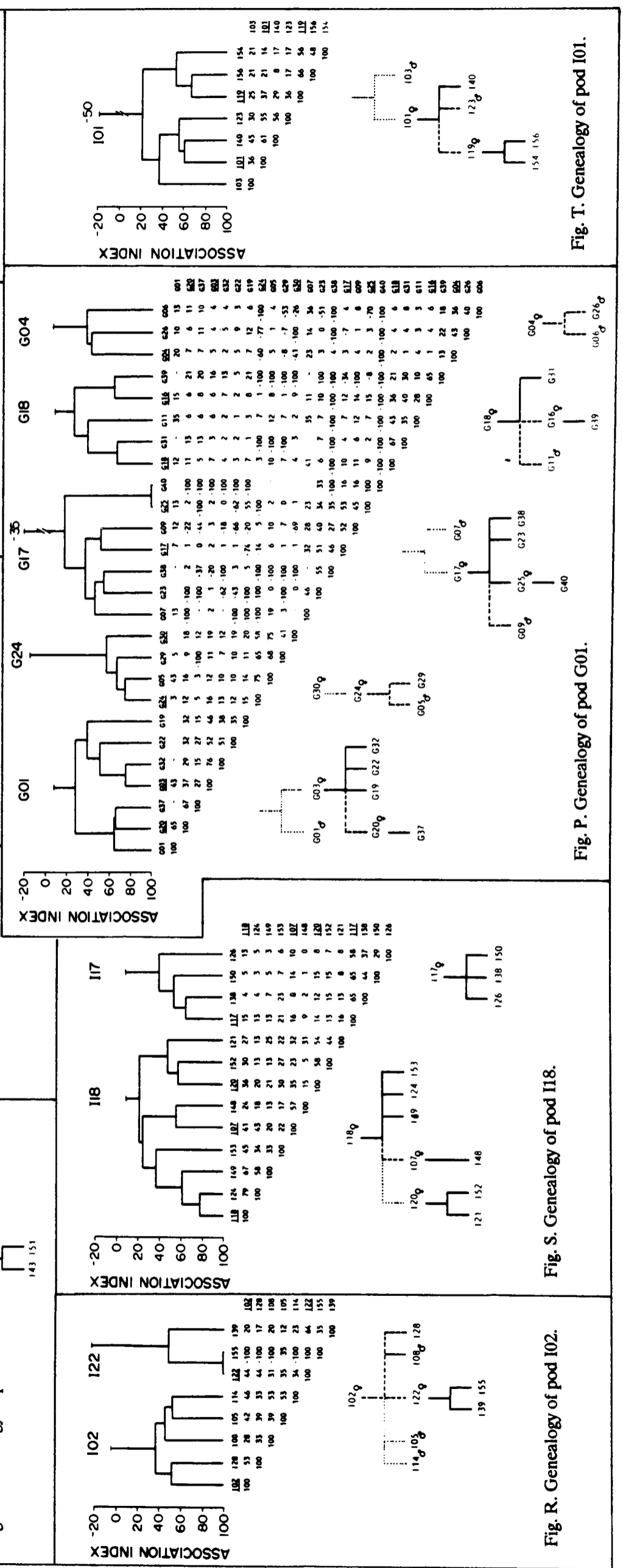
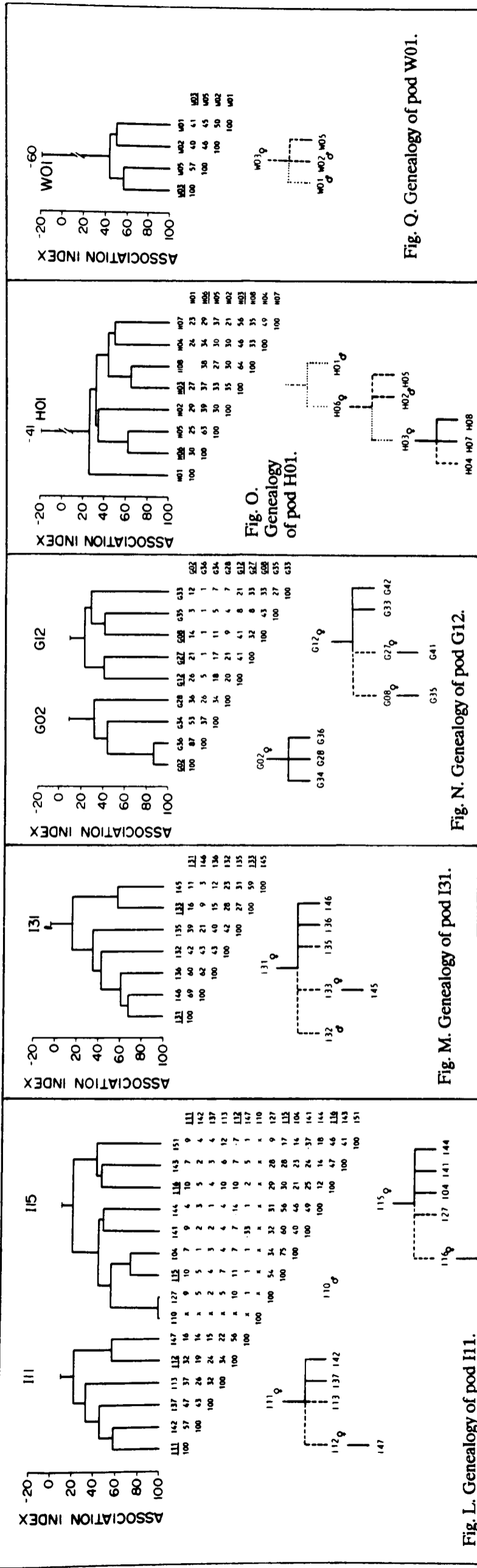

Fig. I. Genealogy of pod A05.



Estimating Bottlenose Dolphin Population Parameters From Individual Identification and Capture-Release Techniques

Randall S. Wells¹ and Michael D. Scott²

ABSTRACT

Field studies begun in 1970 and continuing to date have identified at least three adjacent resident populations (or communities) of bottlenose dolphins along the central west coast of Florida. We have used photo-identification, mark-recapture techniques, behavioral observations, radio-tracking and brief captures for biological sampling to examine the structure and dynamics of these populations. Population designations are based on consideration of individual home ranges, social association patterns and genetics. Although the populations are relatively discrete in terms of ranges and associations, electrophoretic analyses of blood samples indicate that genetic exchange occurs between populations. Males travelling between populations appear to be the probable vectors for genetic exchange.

Most field effort has concentrated on the Sarasota dolphin population. Most of its members are identifiable from natural marks or tagging efforts over the last 20 years. This population consists of about 100 individuals. For the analyses presented here, we considered 116 dolphins identified during 1980–1987. Of these, the sex was known for 90 dolphins and the age has been estimated for 79 dolphins.

The long time span of the study and the high proportion of identifiable individuals has allowed us to estimate vital rates for this population. An annual recruitment rate to age 1 of 0.048 was countered by a minimum mortality rate of 0.010 and a mean annual loss rate from other causes of 0.029 (e.g., emigrations, mortalities for which carcasses were not recovered or undocumented changes in identifying characteristics). Immigration was infrequent, with a mean annual rate about 0.02. The mean fecundity rate was 0.144. Knowledge of maternal relationships allowed comparisons of the percentage of calves observed in the field vs the percentage of young of the year. Because of the prolonged period of association between mothers and calves, there were nearly six times as many mother-calf pairs as mothers with young of the year.

To test the effectiveness of photo-identification techniques, we compared the number of correct identifications made in the field 'by eye' against the number identified from photographs. We identified 89% of these well-marked dolphins correctly by eye. Because virtually all the dolphins were marked in the most-heavily surveyed portion of the study area, it was also possible to test the accuracy and precision of mark-recapture methods. Both the Petersen and Schnabel methods underestimated the known population size, although the Schnabel estimate was less biased. This bias was likely due to heterogeneity of sighting probabilities; different age-sex classes were shown to have different sighting probabilities.

INTRODUCTION

Individual identification can be an effective approach for collecting detailed data on population rate parameters for many free-ranging cetaceans. Repeated observations of recognizable individuals can lead to the definition of population units. Once the population units have been defined, observations of the members of the population can provide data for estimates of population abundance, recruitment through natality or immigration and losses through mortality or emigration. When the age and sex of the identifiable population members are known, it becomes possible to construct models of the dynamics of the populations.

Since 1970, we have used capture-mark-and-release techniques and photographic identification to study bottlenose dolphins (*Tursiops truncatus*) along the central west coast of Florida. As a result of these efforts, we can recognize nearly every member of a resident population of bottlenose dolphins inhabiting the inshore waters near Sarasota and Bradenton. In this paper, we present our analyses of data from long-term studies of this resident population to (1) estimate population rate parameters and (2) test some of the techniques commonly used in field measurements and abundance estimations.

METHODS

Individual identification techniques

Individual identification efforts in the Sarasota area began in 1970. Details of the development of our research program from 1970 to date have been reviewed recently by Scott, Wells and Irvine (1990a) and Wells (in press). Capture-and-release operations during 1970–89 have resulted in the marking of 156 different individuals. Dolphins were captured by encircling small schools with a 500m long by 4m deep net in waters less than 2m deep. We have used a variety of marking techniques during this study including freezebrands, plastic or fiberglass 'button' tags, roto tags, spaghetti tags and radio transmitters (Irvine and Wells, 1972; Irvine, Wells and Scott, 1982; Scott, Wells and Irvine, 1990b).

Mark-and-release captures also provided opportunities to collect additional biological data of relevance to population studies. Currently, we determine the sex, obtain a suite of standard length and girth measurements and collect blood samples for assessments of genetic relationships, health and reproductive condition from all dolphins handled for marking. In addition, we obtain a tooth for age estimation (Hohn, Scott, Wells, Sweeney and Irvine, 1989).

Of the 156 dolphins marked, 122 were residents of the Sarasota area and the other 34 were captured in adjacent areas to the north and south. Thirty dolphins were marked and released during 1970–71, 47 during 1975–76 and 118 during 1984–89. Of the 122 dolphins captured near Sarasota during 1970–89, 107 (55 females and 52 males) have been observed in the area during 1980–89.

¹ Conservation Biology Dept., Chicago Zoological Society, Brookfield Zoo, Brookfield, IL 60513, USA

² Inter-American Tropical Tuna Commission, c/o Scripps Institution of Oceanography, La Jolla, CA 92093, USA

Natural markings have been used to identify individuals since 1970 (Irvine and Wells, 1972). Photography was used during 1970–76 to confirm identifications of tagged and naturally marked dolphins in the Sarasota area (Wells, Irvine and Scott, 1980; Irvine, Scott, Wells and Kaufmann, 1981). Beginning in 1980, we regularly surveyed the Sarasota area and adjacent waters in 5–7m boats (Wells, 1986; Wells, Scott and Irvine, 1987). During these censuses, we photographed all dolphins encountered, including both previously tagged and naturally marked animals. We used 35mm cameras with a variety of fixed and zoom telephoto lenses of up to 300mm, motordrives and databacks. We have found the best film for our situation to be *Kodachrome 64* color slide film, shot at ASA 80. We used shutter speeds of 1/500 or faster.

Observations of naturally marked dolphins have provided some additional information on age and sex of individuals. The seasons of birth have been determined for 54 individuals and 5 frequently seen dolphins are presumed to be adult females because of their regular associations with small calves. At present, our photographic identification catalogue from the Sarasota area and the surrounding region of Florida contains nearly 500 individuals.

Population description

Radio-tracking results combined with sightings of identifiable individuals over periods up to 20 years indicate the existence of resident populations of bottlenose dolphins in the inshore waters of the central west coast of Florida. In a previous description of the dolphins' social structure (Wells *et al.*, 1987), we defined a community as being composed of those individuals

'that shared large portions of their ranges and interacted with each other to a much greater extent than with members of similar units in adjacent waters. This regional society could be considered to be a population, in the broadest sense (for example, Wilson, 1975). However, evidence indicates that this 'population' was not a closed reproductive unit and thus not a population in the strictest sense. The term community was used because it emphasized the geographic and social relationships of the individuals.'

In this paper, we use the term 'population' in this broad sense and we therefore use it interchangeably with the term 'community.'

Several resident populations have been identified in Sarasota Bay and adjacent waters (Wells, 1986; Weigle, 1990). The Sarasota population ranging from Terra Ceia Bay and the southern edge of Tampa Bay southward to Siesta Key, has been the focus of our research efforts since 1970 and is the basis for the analyses presented here (Fig. 1). The Sarasota community home range includes about 100 km² of shallow bays, seagrass meadows, narrow channels and Gulf of Mexico coastal waters. With the exception of occasional absences of some adult males, most of the members of the Sarasota population can be found within this range throughout the year (Wells, 1978; 1986). Within the home range, members frequent different core areas. Females exhibit a high degree of site fidelity. Bands of females, many of whom are related (Duffield, Chamberlin-Lea, Wells and Scott, 1985; Wells *et al.*, 1987), use specific portions of the home range on a regular basis, but may range occasionally throughout the area and interact with members of other female bands. Calves of both sexes tend to remain in the community at least until they reach sexual maturity and typically longer (Wells *et al.*, 1987).

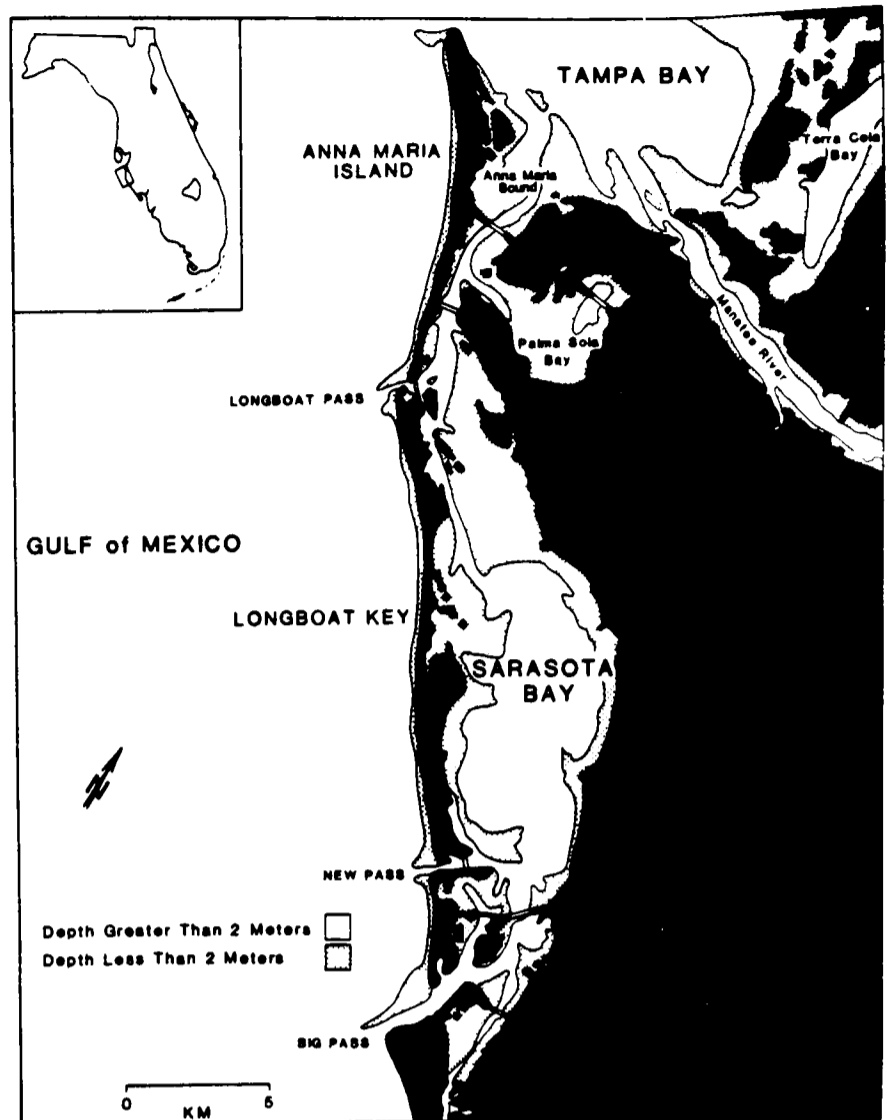

Fig. 1. Map of the Sarasota Bay study area. Inset shows the location of the region on the Florida peninsula.

Males begin to range farther as they mature, apparently traveling from one female band to another (Wells *et al.*, 1987). As adults, some males who were seen regularly as young animals may not be seen in the home range for periods of days to months, or longer. In a case involving the longest range that we have observed, a pair of adult Sarasota males was observed with a school of non-Sarasota females and young 16km north of the previously defined range of Sarasota population members. We suspect that genetic exchange may occur while males are ranging beyond the normal Sarasota home range and similarly when male 'strangers' pass through the Sarasota community range (Duffield and Wells, 1986).

Census efforts have been most consistent in the portion of the home range inhabited by the greatest number of dolphins, including Anna Maria Sound southward to Big Pass (Fig. 1). Virtually all of the regular inhabitants are well known. The waters of the extreme northern portion of the home range, including the Manatee River and Terra Ceia Bay, have not been as accessible for our small boats during regular surveys. As a result, these waters have not been surveyed as consistently and thus the individuals using these waters as their core area are not as well known as are those to the south.

The ability to recognize nearly every Sarasota community member and the observed long-term residency patterns within a stable geographical range provide an unprecedented opportunity to monitor the dynamics of a free-ranging dolphin population. Our regular photographic identification censuses from 1980 to date have been designed to monitor the presence or absence of known individuals and to document recruitment through births and immigration. Mortality data have been provided through the local marine mammal stranding program

Table 1

Roster of known individuals in the Sarasota community and the number of sightings of each one during 1980-1987 (maximum of one sighting per day). The x's indicate those dolphins that were also present during studies in 1970-1971 and 1975-1976. Of these 116 dolphins, the sex is known for 90 dolphins, and the age is known or estimated for 79 dolphins. x = Captured and observed during previous studies. a = Assumed to be present because of sightings during previous and subsequent years. (In some cases, data from 1988 were used to confirm the presence in preceding years).
 d = Mortality confirmed from recovered carcass.

No.	70-71	75-76	80	81	82	83	84	85	86	87	No.	70-71	75-76	80	81	82	83	84	85	86	87
(a) Males											(b) Females										
58	x	x	3	4	1	12	9	3	9	3	5	x	x	10	7	21	36	28	4	14	17
27	x	x	6	5	8	22	14	4	6		7	x	x	9	6	23	34	20	9	12	4
73	x	x	a	a	5	5	4	2	4	5	24	x	x	6	10	19	19	9	3	13	6
112	x	x	a	a	a	1	a	a	a	1	48	x	x	4	7	8	13	6	a	6	a
136	x	x	a	a	a	a	1	a	a	a	1		x	11	9	27	31	29	12	13	23
3		x	11	6	27	29	20	7	13	11	16		x	10	6	18	26	16	8	14	10
11		x	10	4	21	30	21	7	13	6(d)	14		x	8	5	20	29	23	6	11	8
43		x	7	5	8	14	6	3	9	6	2		x	7	6	29	25	18	4	9	5
40		x	7	6	7	14	8	3	9	6	8		x	7	6	21	35	19	10	10	11
56		x	7	5	9	4	6	3	6	6	4		x	6	7	28	29	20	9	17	13
49		x	5	5	9	13	13	4	15	6	22		x	5	5	19	24	16	8	9	7
30		x	4	7	6	25	11	1	4	7	26		x	5	9	13	23	8	4	7	6
132		x	2	1	2	14	12	7	13	15	47		x	5	4	9	15	3	5	6	2
38		x	8	7	3	14	1(d)				10		x	4	6	22	32	18	7	13	16
86		x	5	1							28		x	4	4	6	27	9	5	13	11
39			4	3	11	16	11	4	6	9	32		x	3	5	13	16	14	4	7	11
6			9	7	21	36	28	5	15	10	42		x	3	5	10	19	5	3	3	2
31			7	8	16	22	13	7	12	15	9		x	3	7	32	29	10	4	7	9
34			5	3	12	16	11	4	6	9	35		x	2	8	6	22	12	1	4	4
37			5	8	10	11	8	4	6	6	45		x	6	4	12	9	12	3	1	5
44			1	3	15	15	7	7	10	4	53		x	3	5	20					
41			6	2	8	19	17	5	10	13	62		x	7	8						
74			1	a	6	2	4	2	3	3	68			4	1	4	5	2	4	6	2
90			1	a	a	5	10	4	18	7	59			3	6	7	6	4	3	4	2
82			a	1	5	3	a	1	3	a	21			11	8	15	22	15	4	15	13
12				6	23	35	20	6	13	8	13			3	4	21	35	19	10	11	10
17				3	22	32	16	7	13	11	52			1	4	4	17	5	4	3	2
33				4	12	23	8	2	4	1	79			1	1	3	5	1	a	2	a
36				2	15	16	8	6	8	5	50				4	17	12	7	3	7	6
78					5	5	2	2	2		25				a	19	27	13	3	4	5
107					2	4	9	1	1	3	23				a	22	28	14	3	9	12
67						14	5	3	3	2	20					22	29	19	9	17	12
153							8	3	6	4	15					27	31	30	11	13	18
149							7	1	10	2	141					2	a	6	5	13	9
146							15	6	5	6	18					27	25	18	1		
156							2	5	7	3	61						13	13	4	9	12
142							6	9	12	3	51						25	9	5	13	11
157							6	3	13(d)		147						3	1	4	6	1
154							7(d)				91						6	1	1	3	1
160								2	7	6	151							8	1	15	4
191								3	3	a	148							8	9	9	7
166										4	140							12	8	14	10
											144							9	8	13	20
											145								3	9	9
											164								4	3	2
											159									9	16
											158									1	12
											170									5	a
<i>Total</i>	5	15	25	29	30	31	38	38	38	36	<i>Total</i>	4	22	28	31	34	37	41	43	45	45
(c) Unknown sex																					
60	x	x	3	5	7	4					65			2	6	9	2	a	2	4	
106			2	a	2	1	a	a	2		57			1	15	12	2				
55			4	a	19	1	3	1			123			3							
54			a	3	9	15	1	3			162				2	a	7	1	2	a	
29			2	4	23	16	11				19				30	29	10				
46			6	4	12	9	1				119				a	4	1	a	2	a	
163			1	4	4	17	1				120					2	a	1	3	1	
161			2	a	1	1					155						22	18	24	29	
121			4	1	1						165						1				
66			3	4	10						168						5				
122			3	5	21						171							3			
104			1	a	4						167							1			
117			9								169									9	1
											<i>Total</i>	1	1	13	15	16	14	15	10	7	6

Table 2A

Annual reproductive rates of the Sarasota bottlenose dolphin community. The number of calves born to known mothers (b) is included in the number of known individuals (n). The number of known mature females (f) is also shown as is the number of known births surviving to 1 year (b_1). The number of days a dolphin identification effort is indicated for each year (Fd=field days, Sd=survey days, Cd=capture days). A weighted average was used for the mean; a binomial variance was used to calculate the standard deviation.

	1980	1981	1982	1983	1984	1985	1986	1987	Mean	SD
n=	67	75	81	82	94	91	90	87		
f=	20	25	25	27	27	27	27	30		
b=	7	4	5	5	7	4	4	1		
b_1 =	5	4	5	5	5	2	3	1		
Crude birth rate (b/n)	0.104	0.053	0.062	0.061	0.074	0.044	0.044	0.011	0.055	0.0089
Fecundity rate (b_1/f)	0.250	0.160	0.200	0.185	0.185	0.074	0.111	0.033	0.144	0.0244
Recruitment rate to age 1 ($b_1/(n-b)$)	0.083	0.056	0.066	0.065	0.057	0.023	0.035	0.012	0.048	0.0085
Fd	22	21	77	72	55	20	34	35		
Sd	22	21	77	72	39	12	25	20		
Cd	0	0	0	0	16	8	9	15		

based at Mote Marine Laboratory in Sarasota. Attempts to identify emigration have included tagging efforts and our own photographic identification surveys in Tampa Bay, the Gulf of Mexico, Charlotte Harbor and Pine Island Sound, as well as examination of identification photographs from other researchers working in Tampa Bay (Weigle, 1990) and Pine Island Sound (Shane, in press).

Data base

Data for the following analyses were collected on 336 days on the water during the period April 1980 through December 1987. Of these, 288 days were census days and 48 were capture days.

We recognized 116 dolphins as members of the Sarasota community during the period 1980–87 (Table 1). As of April 1990, 42 of these were known to be males, 48 were females and 26 were of undetermined sex. The ages of 79 dolphins were known from field observations of known mothers or were estimated from examination of growth layers in the teeth. Dolphins were added to the identification catalog over a period of years by photographing naturally marked individuals, by capturing and marking the dolphins or by observing the addition of calves to known mothers in the population. Of the 116 dolphins considered in this paper, 56 (48%) non-calves were identified from natural marks or tags during captures and surveys during 1970–80. Most of the later additions to the catalog were calves born to known mothers; 42 dolphins (36%) were first identified as calves, with 37 of these being born during 1980–1987 and the other 5 being born previously. Seven other dolphins (6%) were marked during capture operations reinitiated in 1984–85. The remaining 11 dolphins (9%) were naturally marked dolphins added to our identification catalog during 1981–85 either because natural marks were newly acquired or changed, or because they immigrated into the area.

Table 2B

Annual mortality, survivorship and loss rates of the Sarasota bottlenose dolphin community. Deaths (d) were scored if a carcass of a known animal was found, if an animal appeared to be diseased and then subsequently disappeared, or if a calf less than 3 years old disappeared from the population. Losses (l) were scored if an animal disappeared, but the cause (mortality, emigration, or undocumented change in marking) was not known.

	1980	1981	1982	1983	1984	1985	1986	1987	Mean	SD
n=	67	75	81	82	94	91	90	87		
For dolphins > 1 year old										
d=	0	0	1	0	2	1	1	1		
l=	0	2	4	2	5	2	3	0		
Minimum mortality rate ($d/(n-b)$)	0.000	0.000	0.013	0.000	0.023	0.011	0.012	0.012	0.010	0.0039
Loss rate ($l/(n-b)$)	0.000	0.028	0.053	0.026	0.057	0.023	0.035	0.000	0.029	0.0066
Maximum mortality rate ($((d+l)/(n-b))$)	0.000	0.028	0.066	0.026	0.080	0.034	0.047	0.012	0.038	0.0076
Minimum annual survival rate ($1 - (d+l)/(n-b)$)	1.000	0.972	0.934	0.974	0.920	0.966	0.953	0.988	0.962	0.0076
Annual survival rate (DeMaster and Drevenak, 1988)	1.000	0.970	0.934	0.973	0.918	0.964	0.953	0.988	0.961	0.0079
For young of the year										
d=	1	1	0	0	2	2	1	0		
Minimum mortality rate (d_1/b)	0.143	0.250	0.000	0.000	0.286	0.500	0.250	0.000	0.189	0.0644
Maximum annual survival rate ($1 - (d_1/b)$)	0.857	0.750	1.000	1.000	0.714	0.500	0.750	1.000	0.811	0.0644
Annual survival rate (DeMaster and Drevenak, 1988)	0.539	0.869	1.000	1.000	0.643	0.630	0.717	1.000	0.803	0.0703

Analyses

Population parameters were calculated for each year as detailed in Table 2. Overall means were calculated as weighted averages. A binomial variance was used to calculate the standard deviations.

POPULATION PARAMETERS

Population size and stability

We estimated the size of the Sarasota dolphin population in two ways, through direct counts of known dolphins and their calves (Table 2) and through mark-recapture (or, more accurately, mark-resight) analyses. The first technique provides a minimum estimate of the total population size because it does not account for dolphins that are not distinctively marked. The second technique takes both marked and unmarked dolphins into account and provides a point estimate with confidence limits.

The number of known individuals increased steadily during the initial compilation of the catalogue from 1980 to mid-1982 and then leveled off thereafter. With the initiation of capture and marking efforts in 1984, the number of known individuals increased markedly with the addition of newly marked dolphins. From 1984–87, the number of known individuals varied less than during the previous four years and variations could be largely accounted for by births and losses to the population (Table 2).

The results of mark-resight analyses suggest that the number of dolphins in the Sarasota population remained relatively stable at approximately 100 individuals over at least a seven-year period. Irvine *et al.* (1981) estimated that the population contained 102 dolphins in 1976 (95% CL = 90–117), based on Lincoln Index calculations. Wells (1986) calculated a Schnabel point estimate of 98 dolphins (95% CL = 89–108) in 1983, of which 82 individuals were known. Minimum estimates of the population size, based on counts of known dolphins during 1983–87, ranged from 82 to 94 individuals (Table 2).

In addition to the constancy of population estimates from mark-resight analyses, the composition of the population also remained stable. At least half of the known individuals in Table 2 (48 dolphins) were accounted for during all eight years of the period 1980–1987. A high proportion of individuals marked in the 1970s were reidentified during the 1980s: 9 of 12 dolphins (75%) marked during 1970–71 and 37 of 47 dolphins (79%) marked during 1975–76 were reidentified in the study area during 1980–87 (Table 1). If the four dolphins known to have died prior to 1980 are deducted from the total, 86% of the remaining dolphins marked in 1975–76 were reidentified.

Recruitment

Dolphins were added to the Sarasota population through births to known community members and probably through immigration.

Natality

By regularly surveying the area, particularly during and after the main calving peak (May–July), we could record the births of calves to known females and monitor their fate. A calf was defined as a presumed offspring that closely associated with an adult female, regardless of the calf's age; calves in their first year of life are referred to as young of the year. The calculated mean annual crude birth rate is 0.055 (\pm SD 0.0089) based on the number of births as a proportion of the total population of known dolphins (Table 2A). This is probably a slight underestimate because on occasion calves may have been born and died before we had a chance to record them. A mean annual fecundity rate of 0.144 was calculated (\pm SD 0.0244) based on the number of young of the year surviving to one year of age that were born to known mature females (Table 2A). Mature females were defined as those known to have given birth, or those indicated to be ovulating over several breeding seasons by an analysis of plasma progesterone concentrations by V. Kirby. This fecundity rate is low compared to the three- to six-year calving interval observed by Wells *et al.* (1987), because of the addition to the mature female category those that had apparently not calved but were sexually mature based on hormone levels. The mean recruitment rate to age 1 was 0.048 (\pm SD 0.0085), based on the number of calves that were born and survived to an age of one year as a proportion of the total population of known dolphins (Table 2A).

The number of calves born annually varied within the Sarasota study area, ranging from a single birth recorded in 1987 to 11 births in 1988. A wide range in birth rates has been reported for other studies of bottlenose dolphins (see reviews by Leatherwood and Reeves, 1982; Perrin and Reilly, 1984), but differences from study to study in birth rates based on percentage of calves may result at least in part from a lack of information on calving intervals and the

Table 3

Age distribution of dolphins identified as calves and the fraction of the total population these age classes comprised. Calves were identified by their close association with their mother. Tagging of both the mother and calf allowed us to monitor the association of the pair even though a distinct size difference was not apparent in the field. During the time of this sample (July, 1986), all the known 3- and 4-year-olds were associated with their mothers. Because many of the 5- and 6-year-olds were independent of their mothers, we did not calculate the fraction of the population they comprised.

	Age in years						
	0-0.9	1	2	3	4	5	6
Calves	3	2	5	4	3	0	1
Fraction	0.034	0.022	0.056	0.045	0.034	-	0.011

age distribution of calves. For example, calves comprised 20% (N=18) of the Sarasota population in July 1986, while the young of the year comprised but 3.5% (Table 3).

The percentage of calves reported here (20%) is higher than values reported elsewhere for bottlenose dolphins (ranging from 2.7–15.6%; Table 18.1, Leatherwood and Reeves, 1982). This is due in part to different definitions of what is a calf. Most field studies define a calf as being a distinctly smaller individual in close association with another larger animal. Because of our tagging efforts, we have been able to identify mother-calf pairs even after there is little size difference apparent in the field. We have monitored associations between mothers and their calves for up to ten years, whereas in most studies an animal larger than a 2- or 3-year old (ranging from about 165–225cm – Hohn, 1980; unpub. data) would not likely be considered a calf. Of greater relevance to estimation of vital rates, however, are the implications of scoring older calves as young of the year and thus overestimating the annual birth rate.

Immigration

Wells (1986) examined the accumulation of new identifications into the photographic catalogue for the Sarasota population and reported that immigration appeared to be an infrequent event. Wells found an initial rapid increase in the number of identifiable dolphins from 1980 to mid-1982, with very few additions to the catalogue from sources other than birth thereafter. Assuming that the initial rate of increase was an artifact of the initial development of the catalogue and that the period after July 1982 reflected the actual dynamics of the population, Wells estimated the annual immigration rate to be 0.032. This rate was based on the additions to the catalog (during August 1982 – January 1984) of three naturally marked dolphins (Nos. 90, 91 and 107) with dorsal fins distinctive enough to have been readily identifiable previously. During subsequent capture operations, photographs of the twisted peduncle of one of these dolphins (No. 90) were matched with photographs taken in 1980 of an animal with the same twisted peduncle, but an unmarked dorsal fin. Thus, the immigration rate calculated by Wells should be reduced to 0.021. This should be considered a maximum estimate, given the potential difficulties in distinguishing between immigration and undocumented changes in the identifying characteristics of existing community members (Wells, 1986; Scott *et al.*, 1990b).

During 1984–87, nine individuals (non-calves) were added to the catalogue, but no new dolphins were added

during 1986–87. Two of the nine were naturally marked while the others were captured and marked. If we assume that all nine were new immigrants, the weighted mean immigration rate is 0.025 per year (\pm SD 0.0082). This assumption is unlikely to be valid, however and this rate is probably an overestimate, particularly given that there were no additions in 1986–87 and that eight of the nine dolphins were not well-marked previously and could have been present without having been identified. Also, 6 of the 9 were of an appropriate age (less than 7 years old) to have been the offspring of resident mothers who had separated from their calves just prior to the 1984 and 1985 captures. In all cases to date where calves of resident Sarasota females were recognizable prior to separation, the independent offspring remained in the community home range after separation.

Losses from the population

Community members were considered lost from the ranks of the identifiable if their carcasses were recovered by the local stranding network, or if they were not resighted during censuses in at least two consecutive years. In addition to mortality, several other possibilities exist for loss from the population, including permanent emigration, undetected changes in identifying characteristics and separation of non-distinctive calves from well-known mothers. In total, 31 dolphins were considered lost from the Sarasota population during 1980–87. An average maximum mortality rate (known deaths plus disappearances) per year of 0.038 (\pm SD 0.0076; Table 2B) was calculated for animals older than one year for 1980–87.

Mortality

A mean annual minimum mortality rate of 0.010 (\pm SD 0.0039; Table 2B) was calculated for the period 1980–87 based on six known or presumed deaths to animals older than one year. These mortalities included four recovered carcasses and two adults observed with extensive skin diseases who disappeared and presumably died. Additionally, seven young of the year disappeared and likely died, yielding a mean mortality rate in the first year of 0.189 (\pm SD 0.0644). The actual mortality rates were probably higher than those reported here; some carcasses recovered by the stranding network were too decomposed to permit identification and some deaths probably did not result in beachcast carcasses. Thus, the true mortality rate for dolphins older than one year probably lies between 0.010 and 0.038.

Different age and sex classes appear to suffer different rates of mortality within the Sarasota population. Of 19 known or presumed deaths recorded during 1976–88, 7 (36.8%) were young of the year, 2 (10.5%) were approximately two-year-old males, 7 (36.8%) were subadults or young adults (<13 years old) and 3 (15.8%) were adults (1 male, 1 female, 1 unknown). Of the 7 subadults and young adults, 5 (83.3%) were males. Thus, young of the year and subadult males appear to suffer the highest rates of mortality. Hersh (1987) reported that young of the year comprised 11.2% of all stranded dolphins in the Indian and Banana River system. It is unclear how this value compares with the rate for the Sarasota population, however, because our lost young of the year were scored based on their disappearances rather than on recovery of their carcasses. Hersh also reported that males comprised 68.2% of the yearling carcasses, but she found that the sex ratios were not skewed for older age classes.

Emigration and other losses

We could not distinguish emigration from other undetermined losses unless the emigrant was identified outside its original community's home range. We have not yet confirmed any permanent emigrations from the Sarasota area during the 1980s, either from surveys by us or other researchers in neighboring areas or from reports by the boating public. A complete lack of emigration would be highly unusual for a large mammal. The recent resightings of an adult male (No. 136) after not being sighted for eight years suggest that at least a small number of community members may shift their core areas outside the community home range for extended periods of time. If all losses other than confirmed or presumed mortalities were considered to be emigration, then the mean annual maximum emigration rate would be approximately 0.029 (\pm SD 0.0066; Table 2B). In all probability, however, the actual mortality rate is higher than 0.010 and thus the maximum emigration rate would be overestimated. Additional losses may result from changes in the identifiability of some dolphins from undocumented changes in dorsal fin markings, or when calves lacking individually-distinctive markings become independent from their marked mothers. In time and as we continue our expanded census coverage into Tampa Bay during 1989–92, we may be able to confirm occurrences of these apparently unusual emigration events.

Annual survival rate

DeMaster and Drevenak (1988) calculated annual survival rates (ASR) for three species of captive cetaceans, including bottlenose dolphins. They calculated the number of animal-days that an individual survived and converted these values to annual rates. We made similar calculations for the Sarasota population for comparison with the data from captives.

We used two methods for calculating ASR. In the first method, we simply subtracted the maximum mortality rates (Table 2B) from 1.0. In the second, we estimated the number of days survived by each individual for each year. Whereas precise values for days survived were available to DeMaster and Drevenak for captives, it was difficult to pinpoint the exact date of death in the wild unless a fresh carcass was recovered. In the case where dolphins disappeared, we assumed the date of death to be that of the last sighting of the dolphin, although this likely biased the estimate downwards slightly. We stratified our sample into two age classes: young of the year and older dolphins.

The two methods produced similar results (Table 2B). Using the method described by DeMaster and Drevenak (1988), we obtained a mean ASR for young of the year of 0.803 (\pm SD 0.0703) during 1980–87. DeMaster and Drevenak calculated a lower ASR for captive calves of 0.61. For older dolphins, we obtained a mean ASR of 0.961 (\pm SD 0.0079) during 1980–87. DeMaster and Drevenak reported a lower ASR for captives of 0.93.

PHOTOGRAPHIC VS FIELD IDENTIFICATION

Our extensive use of photography, even of seemingly well-marked animals, has proved valuable over the years. Real-time identifications 'by eye' alone do not provide the degree of certainty about identifications that is necessary for the kinds of analyses we present here. Our ability to identify by eye the resident Sarasota dolphins was tested by examining a sample of 43 schools observed during 1986 and

1987 for which we had at least four identifiable photographs per recognizable dolphin, indicating that all identifiable dolphins were captured in the photo record (with a 95% probability level; Würsig, 1978; Ballance, 1990). We spent an average of 19.3 min (\pm SD 11.2 mins) with each school. On average, 89.3% (\pm SD 21.8%) of the dolphins present were correctly identified in real time. This is likely a best-case situation for identifying animals in the field because of the long-time familiarity of the researchers with the dolphins and because virtually all the dolphins were well-marked due to the regular capture operations. In addition to providing a more complete and accurate record of dolphins present than is possible simply by eye, the photographic records allowed us to follow changes in identifying characteristics through time and in a number of cases allowed us to distinguish between individuals with nearly identical markings.

MARK-RECAPTURE ESTIMATES

The high proportion of known individuals in this population allowed us to examine some characteristics of mark-recapture estimates for dolphin populations. In the central and southern sections of the area (i.e., Anna Maria Sound, Sarasota and Palma Sola Bays and the passes and shores along the Gulf), 77 dolphins (of which 15 were calves) were known in July 1986. Calves were not included in the mark-recapture calculations because of the lack of independence in sightings of the calves and their mothers. In addition, two of the remaining 62 dolphins had very similar marks at that time (Nos. 146 and 149) and could not always be distinguished. For this reason, their sightings were excluded from the analyses. During 12 days of surveys (3–14 July 1986), only two unmarked dolphins were seen. If each of these sightings were of a different individual, then the population for the purposes of this analysis contained 62 dolphins.

Comparison of different estimators

With the population size known, we could then compare the accuracy of different estimators of population size (\hat{N}). We calculated both Petersen and Schnabel estimates for the 12-day survey period mentioned above. We used the Chapman modification of the Petersen estimator (Chapman, 1951):

$$\hat{N}_i = \frac{(M_i + 1)(n_i + 1)}{m_i + 1} - 1$$

where M_i = the number of different dolphins sighted prior to sampling period i , n_i = the number of different dolphins sighted in sampling period i and m_i = the number of dolphins sighted both before and during sampling period i . We assumed that there were no dolphins marked prior to the surveys and that the dolphins were all individually identifiable and were 'marked' at their first sighting. A maximum of one sighting per individual per sampling period was counted. A different population estimate was calculated for each pair of consecutive days and the series of estimates was averaged. Unweighted and weighted averages were both calculated, the number of marked dolphins present (M_i) being used as the weighting factor. (The standard error of the estimate, which is often used as a weighting factor, could not be used because the high proportion of marked dolphins in the population sometimes yielded recapture rates of one and standard errors of zero.)

The form of the Schnabel estimator used was:

$$[1-(r/\hat{N})] = \sum_{i=1}^s [1-(n_i/\hat{N})]$$

where r = the number of marked dolphins in the population, \hat{N} = the population size, s = the number of sampling periods, and n_i = the number of dolphins sighted in sampling period i (Seber, 1982: Equation 4.4). A single population estimate was produced by solving iteratively for \hat{N} . A 1000-replication bootstrap method was used to estimate the variance and percentile confidence limits (see review by Efron and Tibshirani, 1986).

Each method underestimated the known population size of 62 dolphins (Table 4). The weighted average Petersen estimate of 53 was slightly less biased than the unweighted average of 51, but the series of estimates converged at the end of the survey period to 55, the number of different marked dolphins sighted during the period. The Schnabel estimate of 56 was less biased than the average Petersen estimates. The underestimates produced by these methods are likely due to heterogeneity in sighting probabilities (see below). This effect was particularly evident in the Petersen estimates made early in the 12-day period when there was a lower proportion of 'marked' dolphins in the population. This biased the weighted-average estimate downwards and gave the false appearance of an increasing trend in population size over the period of the surveys.

Table 4

Comparison of Petersen and Schnabel estimators. The Petersen estimates were computed for each pair of consecutive survey days; these estimates were then averaged.

Day i	1	2	3	4	5	6	7	8	9	10	11	12
Petersen Estimator												
M_i	0	19	25	32	33	39	44	49	51	55	55	55
n_i	19	12	17	8	6	15	29	16	17	8	20	16
m_i	0	6	10	7	0	10	24	14	13	8	20	16
N_i	-	36	42	36	-	57	53	56	66	55	55	55
Unweighted Average $N=51.0$ SE = 1.6; 95%CI = (48.7, 55.3)												
Weighted Average $N=53.0$ SE = 1.3; 95%CI = (51.5, 56.7)												
Schnabel Estimator												
[where $r = 55$] $N=56.1$ SE = 1.2; 95% CI = (53.6, 58.2)												

Heterogeneity of sighting probabilities

Heterogeneity in the probabilities of sighting and identifying individuals is a common violation of the assumption of equal 'catchability.' Heterogeneity will cause the population estimates to be biased downwards (e.g., Hammond, 1986). As shown in Table 5, sighting probabilities are not the same for different age and sex classes in this population. Adult males were resighted less frequently than females and the sighting probability decreased as the males matured. In two extreme cases, males that were frequently seen in 1970–71 and 1975–76, were rarely seen in 1980–88 (No. 112 – 3 sightings; No. 136 – 2 sightings). The lower sighting probabilities of the males are due to their greater tendencies to travel outside the community home range, to occur in less-easily sighted small groups and to inhabit areas within the home range which were difficult to survey completely (e.g., the more open waters of Sarasota Bay).

Table 5

Mean sightings per day for each age-sex class in 1980-1984
(from Wells, 1986).

	Mean (SD)	Number of dolphins
Adult females	0.33 (0.12)	23
Subadult males (<8y and <245cm)	0.33 (0.11)	5
Transitional males (8-10y and 245-9cm)	0.18 (0.04)	3
Adult males (>10y and >249cm)	0.15 (0.09)	7

One way that the bias due to unequal identification probabilities can be reduced, however, is to increase the sampling effort so that animals with lower sighting probabilities would be more likely to be sampled. This method requires that (1) marked dolphins are counted at most once during each sampling period regardless of the number of times they are actually sighted and (2) unmarked dolphins are also counted at most once during each sampling period, i.e., once they are sighted during the surveys, they become marked. This latter assumption implies that all individuals can be identified uniquely.

We compared the performance of Petersen and Schnabel estimators as we varied both the number and length of the sampling periods. Both estimators produced less biased results as the number of 1-day sampling periods increased from 2 to 12 days (Fig. 2). As the number of days surveyed increased, the number of dolphins marked also increased. By having a larger number of marked dolphins in the population, the estimated variances decreased.

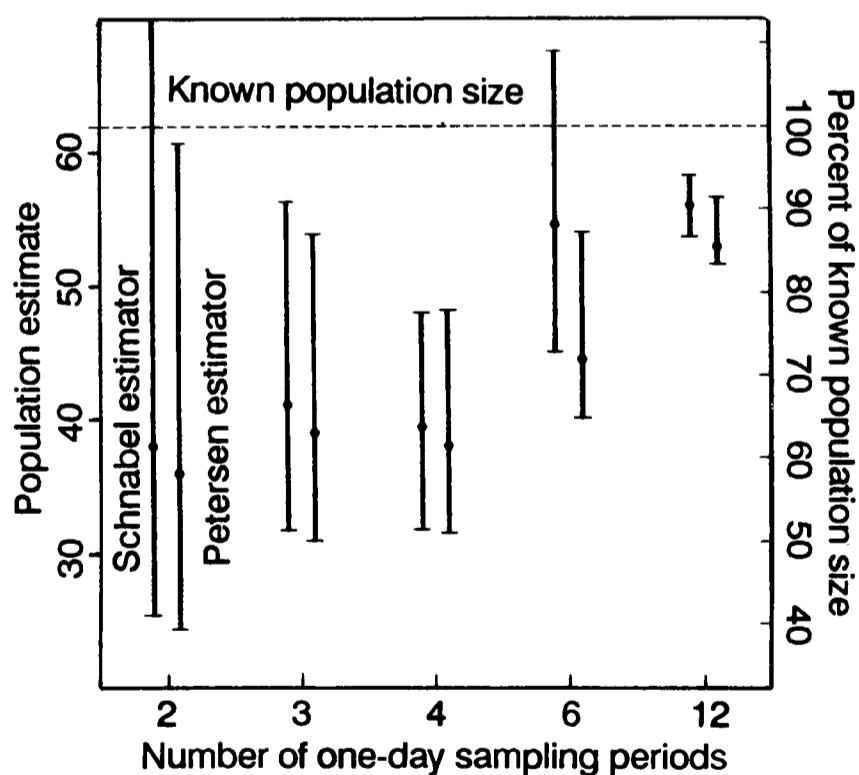

Fig. 2. Population estimates and 95% confidence intervals obtained from samples in which the number of one-day sampling units varied. The population size was known, consisting of 62 dolphins.

We also examined the effect of changing the length of the sampling period from 1 to 6 days, while holding the number of survey days constant (for example, twelve 1-day surveys could be compared with two 6-day surveys). The estimates became less biased when the sampling periods were longer and the estimates from the 6-day samples were the only ones whose confidence limits included the true population size (Fig. 3).

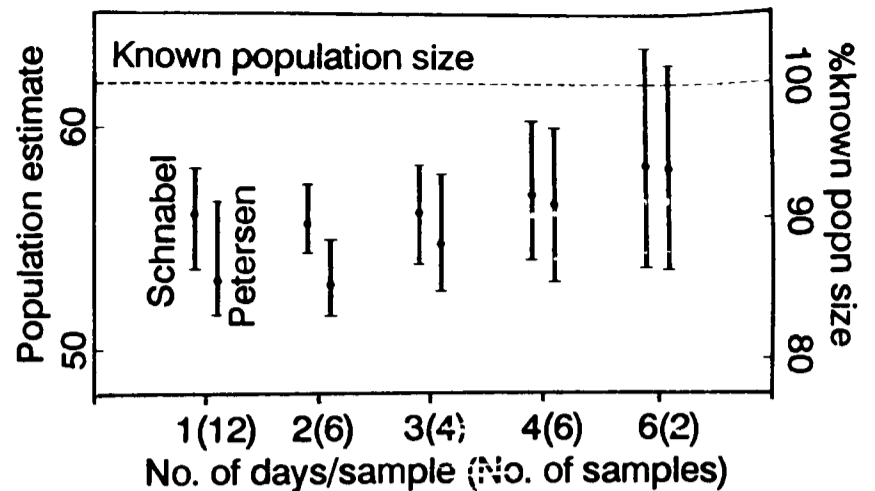

Fig. 3. Population estimates and 95% confidence intervals obtained from samples in which the number of days that comprised a sampling unit varied. The number of these sampling units also varied in order that the total number of days surveyed remained constant.

CONCLUSIONS

Our long-term studies of a well-known resident bottlenose dolphin population have allowed us to begin to compile baseline time series data on population parameters. In addition, this natural laboratory has provided opportunities to empirically test field measurement techniques and some of the more commonly used abundance estimation techniques.

The Schnabel estimator of population size proved to be less biased than the average Petersen estimators. The Petersen estimates produced for each individual sampling period converged toward the Schnabel estimates as the number of sampling periods increased, but this also gave the false appearance of an increasing trend in population size. Both estimators, however, were subject to downward bias caused by heterogeneity. This bias could be reduced by increasing the sampling time and increasing the number of marked animals in the population.

The variances of the estimates can be underestimated if the sighting of one individual is not independent from that of another. We eliminated the calves from this analysis because of the probability of sighting and identifying a calf was not independent from that of its mother. This exclusion, however, removes only the most obvious violation of the assumption of independence of sightings. For social dolphins in general and for this population in particular, associations among individuals are not random and many individuals are sighted consistently together (Wells *et al.*, 1980; 1987). The non-independent probabilities of recognizing individuals would not affect the population estimates, but would have the effect of underestimating the variances (P. Hammond and S. Buckland, pers. comms). Thus, the confidence limits reported here are minimum estimates of the true limits.

Because the precision of the estimate is an important factor in determining the level of change in the population, it underlines the importance of identifying reliably a large percentage of the population. This has implications for the survey designs for examining trends in population sizes, because, as demonstrated by Gerrodette (1987), the number of surveys required to detect a trend will be strongly influenced by the precision of the estimates.

The use of non-lethal techniques such as individual identification and capture-release efforts has provided one of the first data bases of its kind for studies of the dynamics of a resident population of dolphins. The collection of similar kinds of data from other dolphin populations will

allow more in-depth interpretation of the preliminary data presented here. We hope that such time-series data bases can be applied in time to assessing the status of resident dolphin populations and thus towards the use of these animals as biological indicators of the health of inshore ecosystems.

ACKNOWLEDGEMENTS

Field work was supported by Earthwatch, Woods Hole Oceanographic Institution (WHOI), the National Marine Fisheries Service (NMFS), the Inter-American Tropical Tuna Commission (IATTC) and contributions of funds and equipment to Dolphin Biology Research Associates, Inc. (163 Siesta Dr., Sarasota, FL 34242). The analyses for this paper were funded by the Southeast Fisheries Center (NMFS), WHOI and the IATTC. The paper was reviewed by Steve Buckland, Doug DeMaster, Phil Hammond, Aleta Hohn and Hal Whitehead. We gratefully acknowledge the IATTC's Emeritus Black Belt in Statistics, Dr. Steve Buckland, for his help and advice on the mark-recapture analyses.

REFERENCES

- Ballance, L.T. 1990. Residence patterns, group organization and surfacing associations of bottlenose dolphins in Bahia Kino, Golfo de California, Mexico. pp. 267-83 *In: S. Leatherwood and R.R. Reeves (eds) Selected Papers on Bottlenose Dolphins*. Academic Press, San Diego.
- Chapman, D.G. 1951. Some properties of the hypergeometric distribution with applications to zoological sample censuses. *Univ. Calif. Publ. Stat.* 1(7):131-60.
- DeMaster, D.P. and Drevenak, J.K. 1988. Survivorship patterns in three species of captive cetaceans. *Mar. Mamm. Sci.* 4:297-311.
- Duffield, D.A., Chamberlin-Lea, J., Wells, R.S. and Scott, M.D. 1985. Inheritance of an extra chromosome in a resident female group of bottlenose dolphins in Sarasota, Florida. Presented to the Sixth Conference on the Biology of Marine Mammals, Vancouver, Canada, November 1985 (unpublished).
- Duffield, D.A. and Wells, R.S. 1986. Population structure of bottlenose dolphins: Genetic studies of bottlenose dolphins along the central east coast of Florida. Final Report to the National Marine Fisheries Service, Southeast Fisheries Center. Contract No. 45-WCNF-5-00366. 10 pp.
- Efron, B. and Tibshirani, R. 1986. Bootstrap methods for standard errors, confidence intervals and other measures of statistical accuracy. *Stat. Sci.* 1(1):54-77.
- Gerrodette, T. 1987. A power analysis for detecting trends. *Ecology* 68(5):1364-72.
- Hammond, P.S. 1986. Estimating the size of naturally marked whale populations using capture-recapture techniques. *Rep. int. Whal. Commn* (special issue 8):253-82.
- Hersh, S.L. 1987. Characterization and differentiation of bottlenose dolphin populations (genus *Tursiops*) in the southeastern US based on mortality patterns and morphometrics. PhD dissertation. University of Miami. 213pp.
- Hohn, A.A. 1980. Age determination and age related factors in the teeth of western North Atlantic bottlenose dolphins. *Sci. Rep. Whales Res. Inst., Tokyo* 32:39-66.
- Hohn, A.A., Scott, M.D., Wells, R.S., Sweeney, J.C. and Irvine, A.B. 1989. Growth layers in teeth from known-age, free-ranging bottlenose dolphins. *Mar. Mammal Sci.* 5(4): 315-342.
- Irvine, B. and Wells, R.S. 1972. Results of attempts to tag Atlantic bottlenosed dolphins (*Tursiops truncatus*). *Cetology* 13:1-5.
- Irvine, A.B., Scott, M.D., Wells, R.S. and Kaufmann, J.H. 1981. Movements and activities of the Atlantic bottlenose dolphin, *Tursiops truncatus*, near Sarasota, Florida. *Fish. Bull., US* 79(4):671-688.
- Irvine, A.B., Wells, R.S. and Scott, M.D. 1982. An evaluation of techniques for tagging small odontocete cetaceans. *Fish. Bull., US* 80(1):135-143.
- Leatherwood, S. and Reeves, R.R. 1982. Bottlenose dolphin (*Tursiops truncatus*) and other toothed cetaceans. pp.369-414 *In: J.A. Chapman and G.A. Feldhamer (eds) Wild Mammals of North America: Biology, Management, Economics*. John Hopkins Univ. Press, Baltimore. 1,147pp.
- Perrin, W.F. and Reilly, S.B. 1984. Reproductive parameters of dolphins and small whales of the family Delphinidae. *Rep. int. Whal. Commn* (special issue 6):97-133.
- Scott, M.D., Wells, R.S. and Irvine, A.B. 1990a. A long-term study of bottlenose dolphins on the west coast of Florida. pp. 235-44 *In: S. Leatherwood and R.R. Reeves (eds) Selected Papers on Bottlenose Dolphins*. Academic Press, San Diego.
- Scott, M.D., Wells, R.S. and Irvine, A.B. 1990b. Tagging and marking studies of small cetaceans. pp. 489-514 *In: S. Leatherwood and R.R. Reeves (eds) Selected Papers on Bottlenose Dolphins*. Academic Press, San Diego.
- Seber, G.A.F. 1982. *The Estimation of Animal Abundance*. MacMillan Publ. Co., New York. 654 pp.
- Shane, S.H. 1990. Behavior and ecology of the bottlenose dolphin at Sanibel Island, Florida. pp. 245-65 *In: S. Leatherwood and R.R. Reeves (eds) Selected Papers on Bottlenose Dolphins*. Academic Press, San Diego.
- Weigle, B.L. 1990. Abundance, distribution and movements of bottlenose dolphins, *Tursiops truncatus*, in lower Tampa Bay, Florida. Paper SC/A88/P22 (published in this volume).
- Wells, R.S. 1978. Home range characteristics and group composition of Atlantic bottlenosed dolphins, *Tursiops truncatus*, on the west coast of Florida. MS thesis, Univ. Florida, Gainesville. 91pp.
- Wells, R.S. 1986. Structural aspects of dolphin societies. PhD dissertation. Univ. of California at Santa Cruz. 234pp.
- Wells, R.S. In press. The role of long-term study in understanding the social structure of a bottlenose dolphin community. *In: K. Pryor and K.S. Norris (eds) Dolphin Societies: Methods of Study*. Univ. of Calif. Press, Berkeley.
- Wells, R.S., Irvine, A.B. and Scott, M.D. 1980. The social structure of free-ranging bottlenose dolphins. pp.263-317 *In: L.M. Herman (ed.) Cetacean Behavior: Mechanisms and Functions*. Wiley Inter-Science, New York. 463pp.
- Wells, R.S., Scott, M.D. and Irvine A.B. 1987. The social structure of free-ranging bottlenose dolphins. pp.247-305 *In: H. Genoways (ed.) Current Mammalogy*, Vol. 1. 519pp.
- Wilson, E.O. 1975. *Sociobiology: The New Synthesis*. Harvard University Press, Cambridge. 697pp.
- Würsig, B. 1978. Occurrence and group organization of Atlantic bottlenose porpoises (*Tursiops truncatus*) in an Argentine bay. *Biol. Bull.* 154 (2):348-359.



Preliminary/Feasibility Studies

Southern Right whale mother–calf pair, photograph courtesy of Peter Best.

A Feasibility Study on the Use of Photo-identification Techniques for Southern Hemisphere Minke Whale Stock Assessment

Gerald G. Joyce

826 NE 80th Street, Seattle, WA 98115 USA

and

Eleanor M. Dorsey

Conservation Law Foundation, 3 Joy Street, Boston, MA 02108 USA

ABSTRACT

The possibility of using photo-identification techniques for mark-recapture population estimation of Southern Hemisphere minke whales is investigated. Photographs taken during the 1988/89 IWC/IDCR Southern Hemisphere minke whale assessment cruise showed that individuals could be identified but that extensive effort was required to obtain these photographs. It is concluded that with modifications to procedures, this technique may be feasible for obtaining population estimates for Southern Hemisphere minke whales.

INTRODUCTION

There has been considerable discussion in recent years within the International Whaling Commission (IWC) Scientific Committee concerning the value or otherwise of photo-identification techniques for studies of abundant and subtly marked pelagic species such as the minke whale (*Balaenoptera acutorostrata*).

IWC (1990) recommended that a one- to two-day photo-identification feasibility study be conducted during a future IWC/IDCR Southern Hemisphere minke whale assessment cruise. Subsequently, it was recommended that any feasibility study should be preceded by an examination of existing photographs to determine if Southern Hemisphere minke whales can be individually recognized (IWC, 1989). A small collection of photographs was examined, following which an experiment was conducted during the 1988/89 IWC/IDCR Southern Hemisphere minke whale assessment cruise.

IDENTIFICATION OF RECOGNIZABLE MARKINGS

A collection of 65 color slides of Southern Hemisphere minke whales photographed in the Antarctic in the six IWC management Areas (IWC, 1987, p.404) was reviewed for identifiable markings. These photographs were not initially intended for natural marking studies, and in some cases were inadequate in terms of appropriate lighting, angle and clarity, so they were not quantitatively scored. Instead, the entire collection was reviewed to determine if the following elements used in individual recognition of Northern Hemisphere minke whales could be found: (1) unique dorsal fin shapes, (2) areas of pale pigmentation and (3) small white scars (Dorsey, Stern, Hoelzel and Jacobsen, 1990).

All three identification elements were observed in several of the photographs. The animals were close enough to the vessel that the features were quite apparent and the angle of the photographs taken from the bow of the research vessel appeared adequate to display the broadside

profile of the dorsal fin. It was concluded that minke whales in the Southern Hemisphere could be individually recognized using photographs taken during the IWC/IDCR Southern Hemisphere minke whale assessment cruises.

FEASIBILITY EXPERIMENT CONDUCTED AT SEA

Materials and methods

The experiment was conducted aboard two vessels, the *Shonan Maru* and the *Shonan Maru No. 2*, during a three-day period midway through the 1988/89 IWC/IDCR Southern Hemisphere minke whale assessment cruise while the vessels were in transit from Prydz Bay to the eastern sector of Area IV. Research activities were dedicated solely to this experiment aboard the *Shonan Maru No. 2*; the experiment was conducted in conjunction with a biopsy feasibility experiment aboard the *Shonan Maru*. Details of the cruise tracks and general operations are contained in the cruise report (Kasamatsu, Ensor, Mermoz, Shigemune, Nakanishi, Zorin, da Silva, Newcomer and Ohwada, 1989).

Photographs of the animals were taken from the bow and occasionally from the lower deck of each ship using 35mm cameras with 300mm (in some cases 200mm) lenses and *Ilford* HP5 black-and-white film exposed at 400 ASA. Each photographic event and the time involved in obtaining the photographs was recorded. Attempts were made to photograph the left and right side of each whale (Dorsey *et al.*, 1990).

After completion of the cruise, the photographs and other data were examined to determine:

- (1) how many groups that were approached were photographed;
- (2) how many of these animals were photographed with a quality acceptable for photo-identification;
- (3) how many animals that were photographed within the required standards could be individually recognized;
- (4) how much time was required to obtain this sample.

Because the effort dedicated to the photo-identification study aboard the *Shonan Maru* was compromised by the biopsy feasibility study, only effort data recorded on the *Shonan Maru No. 2* were considered.

A single photograph was considered acceptable for photo-identification when it provided a broadside or near-broadside view of the dorsal fin including enough of the body, at sufficient resolution and contrast to show some details of configuration of the flank patch or the shoulder streak. A suite of photographs of a single surfacing that illustrated these features was also considered acceptable.

The amount of time required to obtain adequate sample sizes for capture-recapture estimates of minke whale populations using this methodology can be estimated. IWC (1990) details an exercise carried out to calculate the necessary number of animals to be identified each year for given estimates of population sizes and their coefficients of variation (CVs). Data from this study can be used to estimate the effort required in hours (T_h) to obtain a given number of identified whales using the formula:

$$T_h = N_r(t_w + (t_s / S))$$

where:

N_r = number of whales required

t_w = time in hours required to take an identification photograph of one whale

t_s = time in hours between each minke whale sighting during survey

S = mean minke whale school size

The number of ship days, T_d , this represents was calculated as

$$T_d = T_h / WP$$

where W = the number of working hours in a day and P = the proportion of time spent in the research area in acceptable working conditions.

This does not account for possible reduction of the inter-sighting time by the occurrence of secondary sightings in areas of relatively high minke whale concentrations, but this effect has been minimized by calculating the inter-sighting time only from passing mode (IO mode) surveys where secondary sightings do not occur (Hiby and Hammond, 1989). The possible increase in the time required for each whale to be successfully photographed as a result of either the pursuit of whales already photographed or the common occurrences of equipment failure or operator error, was also not considered in this calculation.

The time between each sighting and the mean school size were calculated from data collected during this cruise, using two areas that should be representative of the areas that would be used in a photo-identification study: the ice edge stratum in the eastern sector, which had moderate whale densities and was located close to the ice, and the southern Prydz Bay area, which had relatively high minke whale densities. Both areas were surveyed by the *Shonan Maru*.

In IWC (1990) the CV was used as a measure of how precise the required estimate of population size should be, in order to calculate N_r . In this paper we calculate N_r using the methods of Robson and Regier (1964). They defined the accuracy of an estimate as

$$1 - \alpha \leq \text{Prob} \left[-A < \frac{N - \hat{N}}{N} < A \right]$$

where:

N = true value of the parameter (in this case population size);

\hat{N} = the estimated value;

A = level of accuracy expressed as a proportion of the value of N ;

α = probability determining the level of statistical certainty.

Robson and Regier (1964) provided formulae and graphs to enable the calculation of the required sample sizes for a two-sample Petersen estimate of a population of approximate known size, N , which would be within the desired level of accuracy, A , for a given proportion of the time, $1 - \alpha$ (see also Seber 1982, pp. 64–9). In this study we chose: $\alpha = 0.05$; $A = 0.5$ and 0.25 ; $N = 50,000$, $100,000$ and $500,000$; and a value of N_r such that it is approximately equal in each sample. Taking the case of $\alpha = 0.05$, $A = 0.25$ and $N = 100,000$ as an example, we are thus calculating the sample sizes required to accept errors in population estimates of up to 25%, i.e. 75,000–125,000, with 95% certainty that these errors will not exceed 25%. The use of A instead of the coefficient of variation (CV) which was used in IWC (1990) puts a different interpretation on the calculated values of N_r .

For the Petersen estimator to be unbiased, a number of assumptions must be met (e.g. Seber, 1982). Those of relevance to photo-identification are that the population is closed, the samples are representative, all animals have the same probability of being identified in each sample, markings are permanent, no matches are missed and no false matches are made (Hammond, 1986).

Results

Table 1 presents the number of groups and animals approached, photographed, photographed suitably for individual recognition and identified to individual. All whales photographed suitably were identified, while some whales that were not photographed within the defined criteria were nonetheless identifiable. Photographs of the latter failed to meet the criteria for photo-identification because configuration of the flank patch and/or shoulder streak was not visible due to poor resolution or being underwater, but a distinct dorsal fin and/or small scars added enough information to make reidentification likely. Two additional animals were identified from a roll of film with no accompanying data to indicate vessel, photographer, date, or sighting number, bringing the total number of identified individuals to 16. For two animals

Table 1

Number of groups and whales approached, photographed, photographed within the defined criteria for individual identification ('Acceptable'), and identified to individuals, by vessel (SM1=*Shonan Maru*, SM2=*Shonan Maru No. 2*).

	Approached		Photographed		Acceptable		No. ID'd	
	groups	whales	groups	whales	groups	whales	groups	whales
SM1	7	27	7	13-17	2	4	2	5
SM2	11	24	7	17	3	7	4	9
	18	51	14	30-34	5	11	6	14

photographed from the right side only, the possibility of a match with another whale photographed only from the left side in a different sighting could not be discounted.

The individually distinctive features observed in these whales were the following: dorsal fin profile, pigmentation and other irregularities; flank patch; thorax patch (distinctive in one whale only); shoulder streak; blowhole streak; small scars; and long scratches (Fig. 1, Table 2). For a description of these features, see Best (1985), Bushuev and Ivashin (1986) and Dorsey *et al.* (1990).

Antarctic minke whales appear to be somewhat easier to recognize than North Pacific minke whales for two reasons: (1) Unlike whales from the North Pacific, Antarctic minke whales have a flank patch that is bright enough to be used to recognize individuals – the flank patch is longer and contains more information than the thorax patch which is useful in the North Pacific (it is also fairly easy to photograph the flank patch in the same frame as the dorsal fin); (2) blowhole streaks in Antarctic minke whales provide a distinguishing feature that has not been found useful in recognizing North Pacific minke whales.

For the *Shonan Maru No.2*, the times required to obtain photographs of 7 individual whales (of 24 encountered) were 1.25 hrs to approach the whales and 2.23 hrs of direct pursuit to photograph them, yielding a time per whale (t_w) of 0.50 hrs. The time between each minke whale sighting

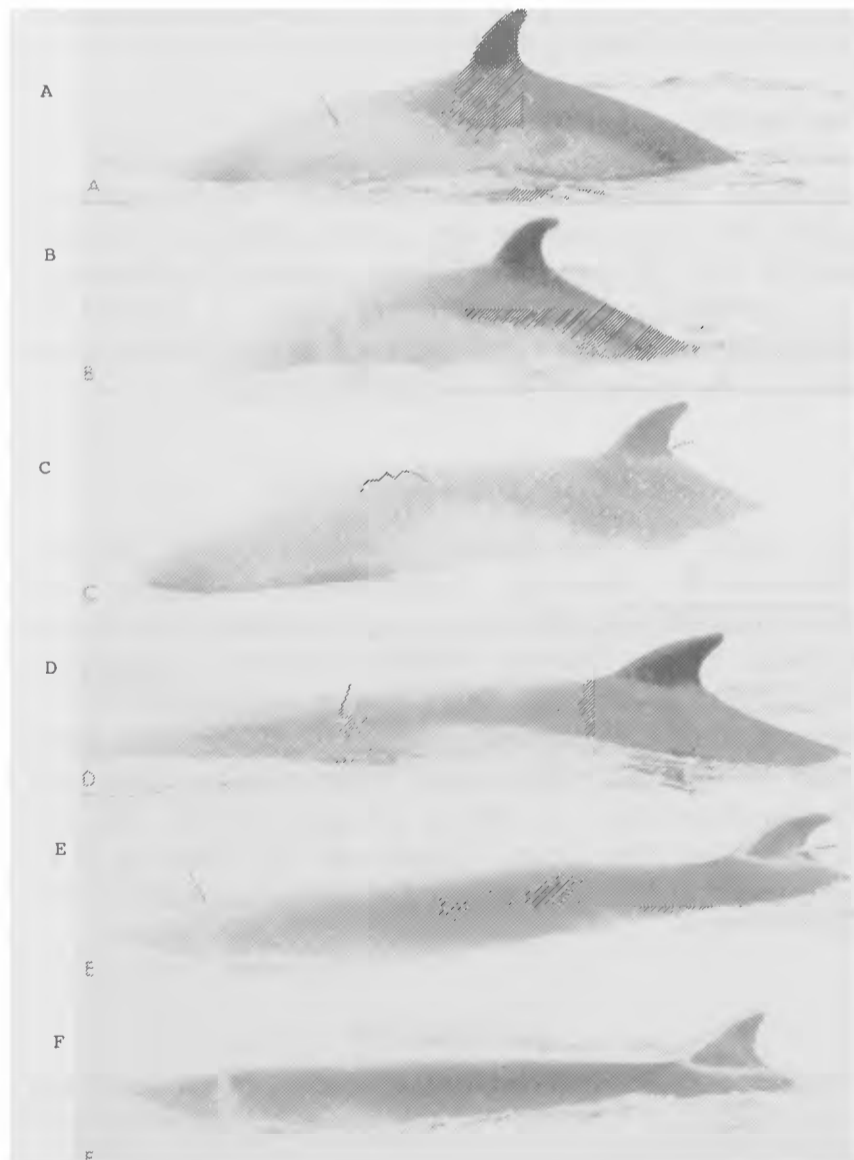

Fig. 1. Six whales identified in the feasibility experiment. Additional features are visible on other photographs of most of these. A. Whale #5 (small scar, dark areas in flank patch). B. Whale #6 (fin and flank patch different from #5). C. Whale #14 (small nick in fin, raised scratch above flank patch). D. Whale #4 (small white scar). E. Whale #16 (nick in fin, possible scar aft of shoulder streak). F. Whale #15 (irregular trailing edge of fin, dark line in shoulder streak).

(t_s) and the mean minke whale school size (S) in the medium-density area was 0.92 hrs and 2.73 animals, respectively, and 0.44 hrs and 4.59 animals, respectively, in the high-density area.

In the IWC/IDCR minke whale assessment cruises the working day, W, lasts 13 hours. From an examination of recent cruise data, a value of $P=0.4$ was chosen.

Table 3 gives estimates of the time required in hours and ship days to obtain photographs of the number of animals that need to be sampled in each of two years based on the chosen values of α , A and N for areas of 'medium' and 'high' density.

DISCUSSION

An approximate comparison can be made between a potential photo-identification capture-recapture experiment and sightings surveys in terms of the amount of effort required to obtain comparable estimates of abundance. Southern Hemisphere minke whale assessment cruises have typically involved two or three vessels searching at sea for 40–50 days. Estimates of abundance have ranged from 55,000 to 300,000 and CVs from 0.156 to 0.285 (IWC, 1989; p.73). In comparing these figures with Table 3, accuracy, A, is roughly equivalent to twice the CV. It is clear that a capture-recapture estimate from photo-identification data is unlikely to be as efficient as a sightings estimate, based on the above calculations. However, collection of photo-identification data could be made more efficient.

It is likely that the mean time required to obtain an acceptable photograph could be reduced in several ways. The percentage of whales approached that were photographed within the established criteria for identification was 15% and 29% respectively for the *Shonan Maru* and the *Shonan Maru No. 2*. The different efficiency between the vessels is probably due to the conflict in priorities with the biopsy feasibility experiment, which took precedence aboard the *Shonan Maru*. Regardless of differences between the vessels, increased efficiency should be obtained once the procedures become more standardized and participants become more experienced in the techniques. For example, many photographs taken from the *Shonan Maru* provided only a single frame per surfacing, and most of these were taken too late in the surfacing to observe much of the whale's body other than the dorsal fin. With experience, photographers would be able to obtain multiple exposures of a single surfacing more often, including photographs taken earlier in the surfacing when more of the whale's body is above water.

The time between minke whale sightings might also be considerably overestimated in this exercise because the reduction in time between sightings due to the aggregation of schools and the localized regions of high whale density is not considered. Kishino and Kasamatsu (1987) have shown that the closing-mode sighting rate that includes all secondary sightings, and thus incorporates some effects of clumping, is higher than the passing-mode sighting rate, which was used in this exercise.

The time required to capture a whale photographically could also be decreased by avoiding small groups that may be difficult to track and approach, and by concentrating pursuit efforts on groups with large school sizes, thereby capturing several whales with nearly the same effort as capturing a single whale. All four groups that were approached in this study, but for which no photographs

Table 2

Distinctive features photographed on 16 identified minke whales

ID#	Sides Photo'd	Dor. Fin Type	Dorsal fin Distinctive Features	Left Side			Right side			Others
				Fp	Ss	Scar	Fp	Ss	Scar	
1	R,L	Lc	Pale wash	x	x	-	x	x	-	Bs
2	R	Sc	-	-	-	-	-	-	x	-
3	R	Lc	Big notch	-	-	-	?	-	-	-
4	R,L	Sc	Welt	?	?	x	?	-	-	-
5	L	Sc	-	x	x	x	-	-	-	-
6	L	Lc	-	x	-	-	-	-	-	-
7	L	Lc	Nick	?	-	x	-	-	-	Scr
8	L	Wb	-	?	x	x	-	-	-	Bs, Es
9	L	Wb	-	-	x	x	-	-	-	Bs
10	R	Lc	Wrinkle	-	-	-	?	-	-	-
11	R	Lc	-	x	-	-	-	-	-	-
12	L	Sc	-	x	-	x	-	-	-	Scr
13	L	Tr	Irr T. edge	?	-	x	-	-	-	-
14	L	Sc	Nick	x	-	-	-	-	-	Scr
15	R,L	Tr	Irr T. edge	-	x	-	?	?	x	?Tp
16	R,L	Lc	Nick	-	?	x	?	-	-	-

Fp = Flank patch; Ss = Shoulder streak; Bs = Blowhole streak; Scr = Scratch; Es = Extra streak;
Lc = Long curve; Sc = Short curve; Wb = Wide base; Tr = Triangular; Tp = Thorax patch;
x = Photographed well; ? = Only general outline visible; Irr T. edge = Irregular trailing edge

Table 3

Effort in hours (T_h) and ship days (T_d) required in each of two years for different population sizes, accuracies and whale densities.

N	A	N_r	T_h	T_d	T_h	T_d
50,000	0.5	1080	904	174	644	124
	0.25	1800	1507	290	1073	206
100,000	0.5	1540	1289	248	918	177
	0.25	2580	2159	415	1537	296
500,000	0.5	3470	2904	558	2068	398
	0.25	5840	4888	940	3480	669

were obtained, were single whales. However, this may affect the representativeness of the sample if there is segregation in group composition in minke whales.

Future photo-identification studies may also be enhanced by changes in procedures. Because of the difficulty in maneuvering vessels as large as whale catchers, poor resolution due to distance from the whale may continue to occur, as may the tendency to photograph only one side of the whale (75% of the identified whales in this study were photographed from only one side). Photo-identification studies in the North Pacific have been successful in obtaining close-up photographs of both sides of minke whales by working from small (4–7m) outboard motor boats, which are highly maneuverable and can accelerate rapidly from motionless to full speed, although no calculations have been made on the effort required to obtain these data (Dorsey, 1983; Dorsey, *et al.*, 1990). Use of smaller boats might be considered if further photo-identification studies are undertaken in the Antarctic.

Photo-identification of minke whales has been successful to date in distinguishing only tens of animals (Dorsey *et al.*, 1990), not the thousands that would be required for population estimates in the Antarctic. The photographs obtained in this feasibility experiment suggest that such large numbers may be possible.

Certainly difficulties would be introduced in the handling and analysis of a large volume of minke whale photographs. The implementation of computer-aided matching (see IWC, 1990 item 8.3) would be extremely valuable in facilitating these tasks.

Conclusions

Individual Southern Hemisphere minke whales can be identified but photo-identification mark-recapture techniques for estimating the entire population are not feasible with the capture efficiency obtained in this study and available resources. Further work is needed in developing methods to increase capture efficiency and to improve the efficiency in matching individuals.

ACKNOWLEDGMENTS

The funds for this research were supplied by the International Whaling Commission. Support for developing photographs using special processes was made available by the National Marine Mammal Laboratory, NMFS/NOAA, Seattle, WA, and in particular Ms. S. Mizroch. Our special thanks to the researchers who spent hours on the cold, windy bows of the *Shonan Maru* and *Shonan Maru No. 2* to obtain the photographs. Ms. M. Moon edited this paper. Thanks are also due to G.P. Donovan and P.S. Hammond for useful additions to the text.

REFERENCES

- Best, P.B. 1985. External characters of southern minke whales and the existence of a diminutive form. *Sci. Rep. Whales Res. Inst., Tokyo* 36:1–33.
- Bushuev, S.G. and Ivashin, M.V. 1986. Variation of colouration of Antarctic minke whales. *Rep. int. Whal. Commn* 36:193–200.
- Dorsey, E.M. 1983. Exclusive adjoining ranges in individually identified minke whales (*Balaenoptera acutorostrata*) in Washington State. *Can. J. Zool.* 61(1):174–81.
- Dorsey, E.M., Stern, S.J., Hoelzel, A.R., and Jacobsen, J. 1990. Minke whales, *Balaenoptera acutorostrata* from the west coast of North America: individual recognition and small-scale site fidelity. Paper SC/A88/ID21 (published in this volume).

- Hammond, P.S. 1986. Estimating the size of naturally marked whale populations using capture-recapture techniques. *Rep. int. Whal. Commn* (special issue 8):253-82.
- Hiby, A.R. and Hammond, P.S. 1989. Survey techniques for estimating abundance of cetaceans. *Rep. int. Whal. Commn* (special issue 11):47-80.
- International Whaling Commission. 1987. *Thirty-Seventh Report of the International Whaling Commission*. International Whaling Commission, Cambridge. i-ix+404pp.
- International Whaling Commission, 1989. Report of the Scientific Committee. *Rep. int. Whal. Commn* 39:33-70.
- International Whaling Commission. 1990. Report of the Workshop on Individual Recognition and the Estimation of Cetacean Population Parameters. (published in this volume).
- Kasamatsu, F., Ensor, P., Mermoz, J., Shigemune, H., Nakanishi, S., Zorin, A., da Silva, V., Newcomer, M., and Ohwada, A. 1989. Report of the 1988/89 IWC/IDCR Southern Hemisphere minke whale assessment cruise, Area IV. Presented to the IWC Scientific Committee, June 1989.
- Kishino, H. and Kasamatsu, F. 1987. Comparison of the closing and passing mode procedures used in sighting surveys. *Rep. int. Whal. Commn* 37:253-8.
- Robson, D.S. and Regier, H.A. 1964. Sample size in Petersen mark-recapture experiments. *Trans. Amer. Fish. Soc.* 93:215-26.
- Seber, G.A.F. 1982. *The Estimating of Animal Abundance and Related Parameters*. 2nd Edition, Griffin, London.

An Examination of the Feasibility of Using Photo-Identification Techniques for a Short-Finned Pilot Whale Stock off Japan

Tomio Miyashita and Toshio Kasuya

Far Seas Fisheries Research Laboratory, 5-7-1 Orido, Shimizu-shi, Shizuoka-ken, 424 Japan.

and

Kyoichi Mori

Department of Marine Resources, Tokai University, 3-20-1 Orido, Shimizu-shi, Shizuoka-ken, 424 Japan.

ABSTRACT

A total of 353 photographs of a geographically limited small stock of short-finned pilot whales are examined to determine their usefulness for individual identification based on characteristics of the dorsal fin and the saddle mark. They are shown to be suitable for the recognition of individuals other than calves, 101 individuals being identified. The frequency of two saddle mark characters differ significantly among schools, suggesting that they may be under genetic control and that school members are often genetically related. Proportions of adult males and calves in the population agree with figures estimated from information obtained from animals taken in fisheries. The approach thus appears useful for monitoring population structure and reproduction.

INTRODUCTION

Of the two forms of short-finned pilot whale (*Globicephala macrorhynchus* Gray, 1846) known off the Pacific coast of Japan (Kasuya, Miyashita and Kasamatsu, 1988), only the northern form has a distinct saddle mark potentially suitable for individual identification, although characteristics (shape, scars, notches etc.) of the dorsal fin can be used for both forms. Distribution of the northern form is limited to shallow coastal waters off Japan between the fronts of the cold Oyashio and warm Kuroshio Currents (12°-24°C surface temperature; 35°-43°N and west of 149°E). The population of about 5,300 individuals (Miyashita, 1986) has been exploited by Japanese small-type whaling (28-172 individuals per year) since 1982 (Kasuya and Tai, 1986).

In 1986, a photo-identification project on the northern form was begun using photographs of the dorsal fins and saddle marks of both free-ranging individuals and whales caught in the fishery. The objectives of the project were to investigate social structure, reproduction and the effect of exploitation on the stock. This paper presents a preliminary analysis of the photographs to examine the applicability of the technique for the stock.

MATERIALS AND METHODS

Most of the photographs of free-ranging individuals were taken during two sightings cruises in 1986 and 1987, using 35mm cameras with a zoom (80-200mm, 100-300mm) lens and usually using colour slide film (ASA 64, 100, 200 or 400). The shutter speed was 1/500s or faster. The photographs were taken by either the authors or a professional photographer (Mr M. Ichihara). Additional photographs were available for schools sighted and photographed opportunistically during three earlier cruises (1975-1985). The total number of potentially suitable photographs was 353 (2 in 1975, 7 in 1982, 14 in 1985, 142 in 1986, 188 in 1987), obtained from 14 encounters with presumed schools containing an estimated 629 individuals.

Animals taken by the fishery were first photographed in 1983, the second year of exploitation. Analysis of these has been completed only for the catches in 1986 (28 whales represented by 22 left hand side and 21 right hand side photographs); no matches with photographs of free ranging individuals were found. The analyses below have therefore been restricted to the free-ranging individuals.

Photographs were examined using a magnifier (4x) and sketched on paper to enhance useful markers such as nicks on the dorsal fin, the contour of the saddle mark and scars on the back. When two sketches were found to be similar, the original photographs were compared.

Adult males were identified by their long-based dorsal fin and large body size; animals were considered calves if they were small and accompanying a larger individual at a close distance. The calves did not have saddle marks that were distinct enough for individual identification from a photograph.

Since the saddle marks were bilaterally asymmetrical, the analyses were carried out separately for both sides.

RESULTS

Individual identification and resightings

From 353 photographs, 96 individuals were identified from the left side (LHS) of the body and 101 from the right side (RHS). Some schools that were apparently separate when first sighted merged while they were chased and photographed. Thus, of the above figures for both sides of the body, 31 individuals were unable to be assigned to school.

Two whales in a school photographed in September 1982 were resighted in September 1986, again in the same school. They were 116 n.miles from the position of the first sighting (Fig. 1). In 1987, three individuals in one school and one individual from another school were resighted on the following day, 17.4 and 14.4 n.miles from the localities of the initial sightings, respectively.

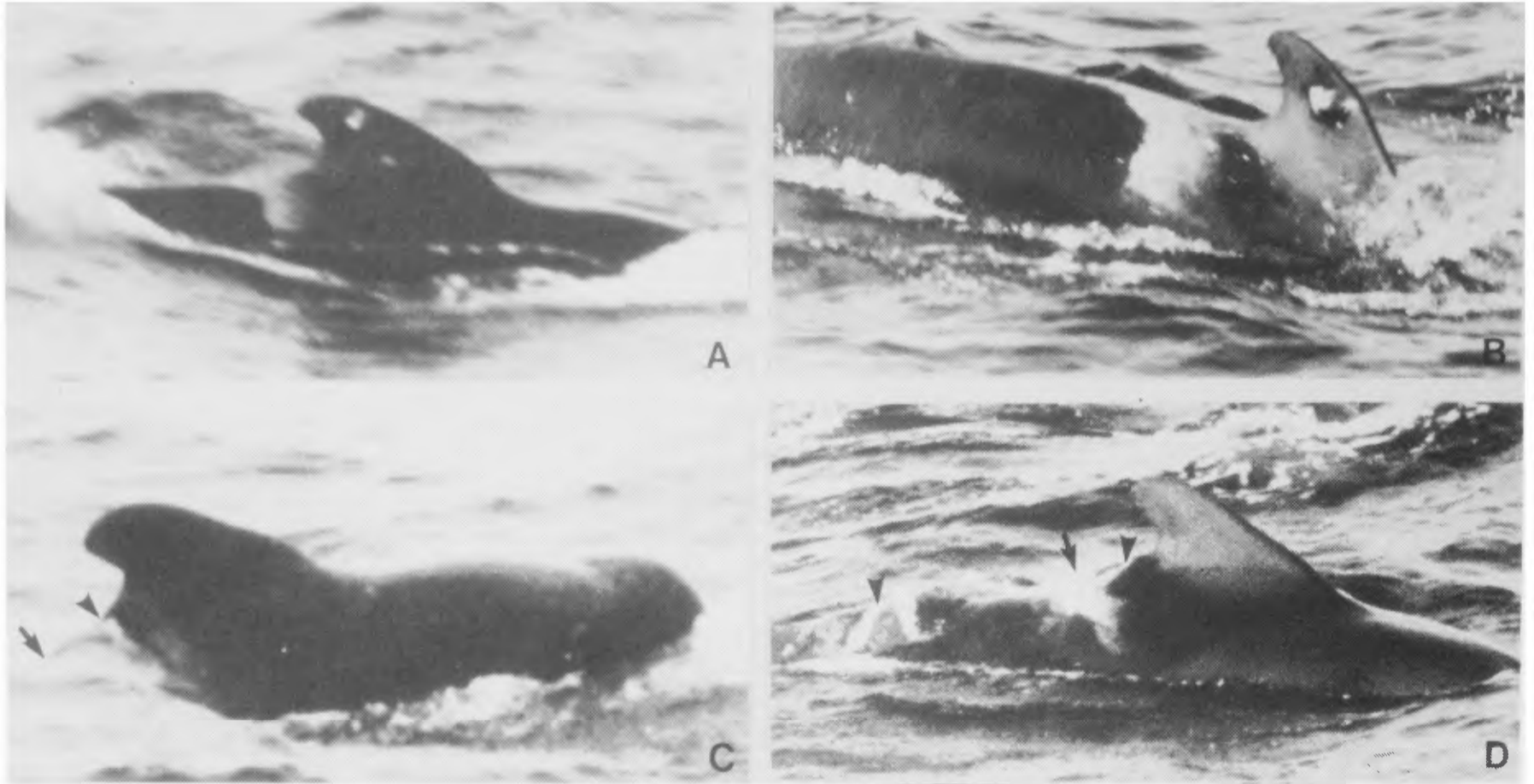

Fig. 1. Two whales sighted in the same school on 19 September 1982 and 15 September 1986. Whale no. JCr3; A: first sighting and B: second sighting, identified by shape of saddle mark (ordinary type) and white patch on dorsal fin. Whale no. JCr2; C: first sighting and D: second sighting, identified by large deep scar (arrow heads: presumably caused by ship's screw), saddle mark (arrows) and shape of dorsal fin.

Saddle mark characteristics

The frequency of two saddle mark characteristics varied among schools: (1) a dark chevron patch in the saddle mark (Fig. 2); and (2) a small saddle mark with a clear anterior margin (Fig. 3) – saddle marks of other individuals gradually faded into the dark-pigmented area of the body (Fig. 4).

The first was present only on whales (6 out of 11 LHS and 4 out of 8 RHS) in one school (school JK, of 28 individuals); none of the whales were adult males. The frequency was significantly different from that for other schools (0/43 LHS and 0/53 RHS) (Fisher's exact test *in*

Snedecor and Cochran, 1967, $P = 0.000018$ for the left side, $P = 0.000103$ for the right side, using only schools with six or more observations).

Occurrence of the second characteristic is listed in Table 1. Four whales were adult males (two animals each in schools JG and JC). A test of homogeneity of variance (Sokal and Rohlf, 1981) showed that the frequencies were significantly different among schools (LHS: chi-square = 14.132, $df = 4$, $P < 0.01$, and RHS: chi-square = 15.443, $df = 6$, $P < 0.02$, using schools with six or more observations).



Fig. 2. Dark chevron patch in saddle mark (arrow).

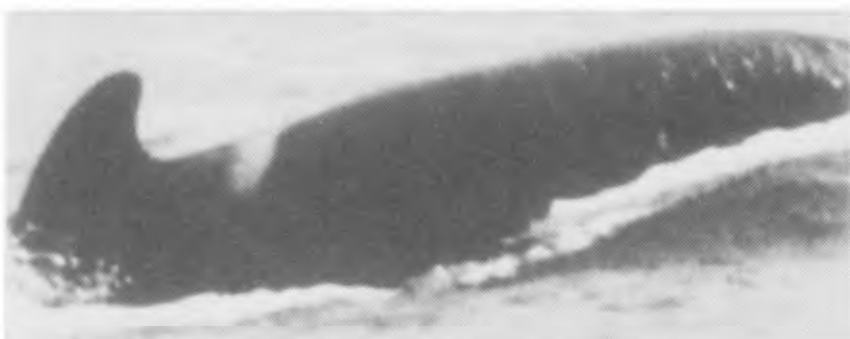

Fig. 3. Small dorsal patch with clear anterior margin.

School structure

The proportion of adult males of those individuals identified was 14.6% (LHS) or 12.9% (RHS). Because the photographs were taken randomly in each school, these figures probably represent the average proportion of adult males in the schools. They agree with the proportion of sexually mature males (13.0%) found in southern form short-finned pilot whales caught by a drive fishery (Kasuya and Marsh, 1984); the two forms are known to have similar life histories (Kasuya, 1986; Kasuya, *in press*).

The individual identification of calves was not possible because the saddle marks were unclear. We assumed that each calf continued to follow, at least during photographing, only one large whale (possibly the mother) which was identified. The calves, which were thus indirectly identified, accounted for 5.2% (3 LHS calves) or 11.2% (12 RHS calves) of the total number of identified individuals *including* calves. These values are again of the same order of annual calf production (5.8%) estimated for the southern form of the short-finned pilot whale (Kasuya and Marsh, 1984).

Individuals other than calves and adult males (*i.e.* adult females and subadults of both sexes) accounted for 80.2% (79 LHS whales) or 75.9% (76 RHS whales).

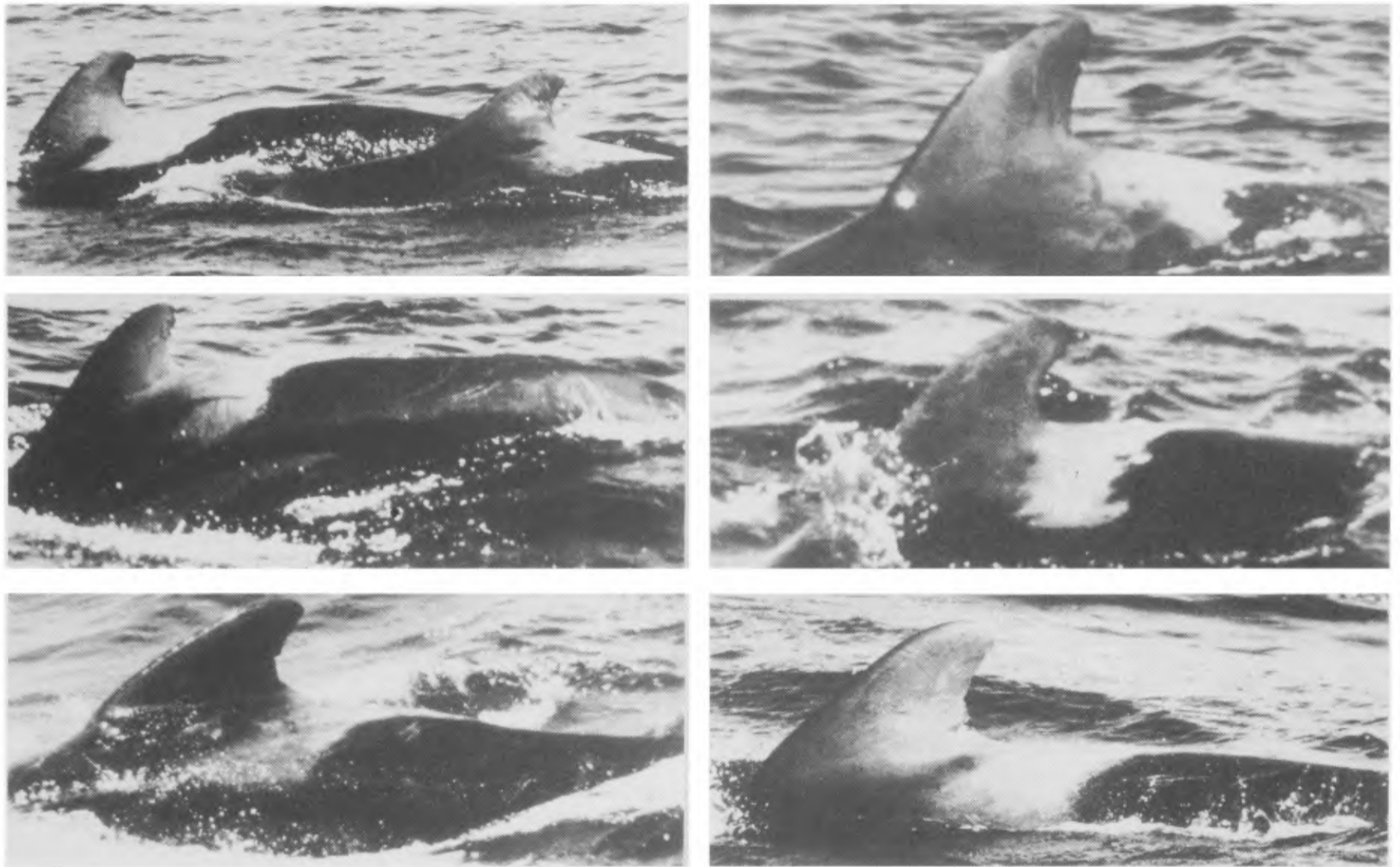

Fig. 4. Typical saddle marks fade into the dark-pigmented area of the body. Some individuals have nicks on the posterior edge of the dorsal fin.

Table 1

Between-school comparison of the frequency of the small saddle mark having a clear anterior margin.

	JC	JD	JE	JG	JH	JI	JJ	JK
<i>Left side</i>								
No. identified	-	14	6	8	-		6	13
Small and clear	-	0	2	4	-		1	0
Ordinary	-	14	4	4	-	-	5	13
<i>Right side</i>								
No. identified	6	6	7	-	12	6	12	10
Small and clear	4	0	1	-	4	1	1	0
Ordinary	2	6	6	-	8	5	11	10

DISCUSSION

Kasuya (1986; in press) has compared life history parameters for the two forms of short-finned pilot whales found off Japan and concluded that the only differences between the two stocks are that the northern form has (1) a larger body size and (2) a shorter and later breeding season. There is good evidence that life history parameters are similar in the two forms e.g. age at maturation; longevity; calving interval; and length of post-reproductive lifetime in females. Thus one might expect to find similar proportions of adult males in the two populations. Additionally, Kasuya and Marsh (1984) found that calves of the southern form start to take solid food at between 0.5 and 1 years, although they continue to take both milk and solid food for a longer period. A calf will, therefore, probably not remain closely associated with its mother for

much over 1 year, suggesting that the proportion of calves can be used as an approximate indication of annual pregnancy rate. The good agreement of these parameters using the two methods indicates that the photo-identification technique is useful for monitoring population structure.

The above analysis has shown that certain saddle mark characteristics are more frequent in some schools than in others. One possible explanation is that these characters are under genetic control and that some individuals in a school are genetically related. Kasuya and Marsh (1984) deduced, from their analysis of schools taken by a drive fishery, that the southern form has a multi-male polygynous breeding system and lives in matrilineal cohesive schools, which may contain several generations of females. The similarity in population parameters found between the two forms suggests that a similar social structure occurs in the northern form (Kasuya, in press), lending some support to the above interpretation of saddle mark frequency.

In conclusion, this study has shown that adult northern form short-finned pilot whales can be individually identified, at least in the short-term, using the shape of the dorsal fin and the saddle mark.

ACKNOWLEDGEMENTS

We wish to express our thanks to Dr H. Kato, Far Seas Fisheries Research Laboratory, and to two anonymous reviewers for reviewing the manuscript. Ms C. Shimazu helped us in data analysis.

REFERENCES

- Kasuya, T. 1986. Comparison of life history parameters between two stocks of short-finned pilot whales off the Pacific coast of Japan. Paper SC/38/SM10 presented to the IWC Scientific Committee, June 1986. 32pp.
- Kasuya, T. In press. Life history of short-finned pilot whale stocks off Japan. *Rep. int. Whal. Commn* (special issue).
- Kasuya, T. and Marsh, H. 1984. Life history and reproductive biology of the short-finned pilot whales, *Globicephala macrorhynchus* off the Pacific coast of Japan. *Rep. int. Whal. Commn* (special issue 6): 259-310.
- Kasuya, T., Miyashita, T. and Kasamatsu, F. 1988. Segregation of two forms of short-finned pilot whales off the Pacific coast of Japan. *Sci. Rep. Whales Res. Inst., Tokyo* 39: 77-90.
- Kasuya, T. and Tai, S. 1986. Operation of Japanese small-type whaling on the short-finned pilot whale off the northeastern Japan. Paper SC/38/SM16 presented to the IWC Scientific Committee, June 1986. 16pp.
- Miyashita, T. 1986. Abundance of some globicephalid cetaceans in the adjacent waters of Japan. Paper SC/38/SM17 presented to the IWC Scientific Committee, June 1986. 18pp.
- Snedecor, G.W. and Cochran, W.G. 1967. *Statistical Method*. 6th ed. Iowa State Univ. Press, Ames, Iowa. 593pp.
- Sokal, R.R. and Rohlf, F.J. 1981. *Biometry*. 2nd ed. W.H. Freeman and Company, New York. xviii+859pp.

Photo-Identification Techniques Applied to Dall's Porpoise (*Phocoenoides dalli*) in Puget Sound, Washington

Elizabeth J. Miller

University of Washington, School of Fisheries, Seattle, Washington 98195, USA.¹

ABSTRACT

Dorsal fin photographs of Dall's porpoise, *Phocoenoides dalli*, were taken in northern Puget Sound, Washington in order to assess the feasibility of using photo-identification techniques in studies of this species. Twenty percent of the photographs were suitable for identification. Thirty-five porpoises were identified using the left side of the dorsal fin, and 28 porpoises were identified using the right. The techniques were applied to investigate group structure and calculate abundance estimates for the study area. Resightings of identified animals were infrequent, and few associations between animals were observed within the study area. Average distance between resightings of individuals was 5.4km. Abundance was assessed through mark-recapture analyses and direct counts of identified animals.

INTRODUCTION

The study of the social behavior of wild cetaceans has been facilitated by improved tagging techniques, radio telemetry, the recognition of naturally marked animals and the use of photographs to identify animals with natural marks. Photo-identification techniques are particularly useful for non-intrusive long-term studies (e.g. see IWC, 1990), in contrast to the short-term nature of many types of tags or a radio pack. Photo-identification has been especially successful in areas where animals occur close to shore because they are accessible for shore-based or small boat studies (e.g. see Würsig and Jefferson, 1990).

The possibility of identifying individual Phocoenids has been discussed by several authors. Silber, Newcomer and Barros (1988) noted uniquely marked individuals of *Phocoena sinus*, while Norris and Prescott (1961) and Morejohn, Loeb and Baltz (1973) found uniquely marked Dall's porpoises (*Phocoenoides dalli*). Jefferson (1986) suggested that individual Dall's porpoises might be identified by the pattern of black flecking on the white frosting of the dorsal fin (Fig. 1). These marks have not been demonstrated to be characteristic of individuals over time, but may be analogous to the natural markings of other cetaceans, some of which appear to be quite durable (see review by Würsig and Jefferson, 1990).

One reason that a comprehensive photo-identification study of Dall's porpoise has not yet been carried out is because it is difficult to obtain an adequate sample of photographs. In particular, the behavioral idiosyncrasy of producing a rooster tail splash when surfacing frequently obscures at least part of the dorsal fin, and makes it difficult to discriminate detail.

Several investigators have photographed individual Dall's porpoises (Ken Balcomb, Center for Whale Research, pers. comm.; Chuck Flaherty, Whales World, pers. comm.; Tom Jefferson, San Jose State University, Moss Landing Laboratory, pers. comm.), but never in sufficient numbers to be quantitatively analyzed. These unpublished photographs demonstrate that individual Dall's porpoises are distinguishable, at least in the short

term. However, until now, no set of characteristics appropriate to quantify the identification of individual Dall's porpoises has been defined.

This paper presents the results of a year-round study of the behavior and distribution of Dall's porpoise in northern Puget Sound. Photographs of individual Dall's porpoises were analyzed using photo-identification techniques. The feasibility of using photo-identification to study Dall's porpoise is discussed, and a preliminary analysis is presented on the structure and stability of groups in the area. In addition, an estimate of the monthly abundance in the study area was calculated based on mark-recapture analysis using photographs.

METHODS

Dall's porpoise have been reported to occur throughout Puget Sound in all months of the year (Everitt, Fiscus and Delong, 1980). The study area was selected because of its central location in northern Puget Sound. It extends roughly from the south tip of Whidbey Island in the north, to Apple Cove Point in the southwest, and Edmonds, Washington in the southeast, encompassing approximately 100km² (Fig. 2). Three additional surveys were made beyond the boundaries of the study area to investigate the distribution and range of the porpoises. These surveys were performed within a 32km radius north of the study area.

Data collection

Photographs and field data were collected from a 5.1m *Boston Whaler*. Sampling consisted of both systematic transect surveys and focal animal sampling (FAS) (Altman, 1974). Both kinds of sampling were weather dependent, based on wind and sea state conditions. In order to optimize the probability of sighting animals, and to reduce the variability of sighting conditions between days, sampling was only conducted during sea states of Beaufort 2 or less. Periods of bad weather (wind, rain and choppy seas) are common in the Pacific Northwest, so consequently, the sampling schedule was inconsistent. Sampling was conducted between 7 May 1987 and 8 June 1988, during all months except November.

Transect surveys were performed in order to investigate the relative abundance of porpoises in the study area over time. Transects were set at 1.7km intervals throughout the

¹ Current address: National Marine Mammal Lab., Alaska Fisheries Science Center, 7600 Sand Point Way NE, Seattle, WA 98115-0070, USA.

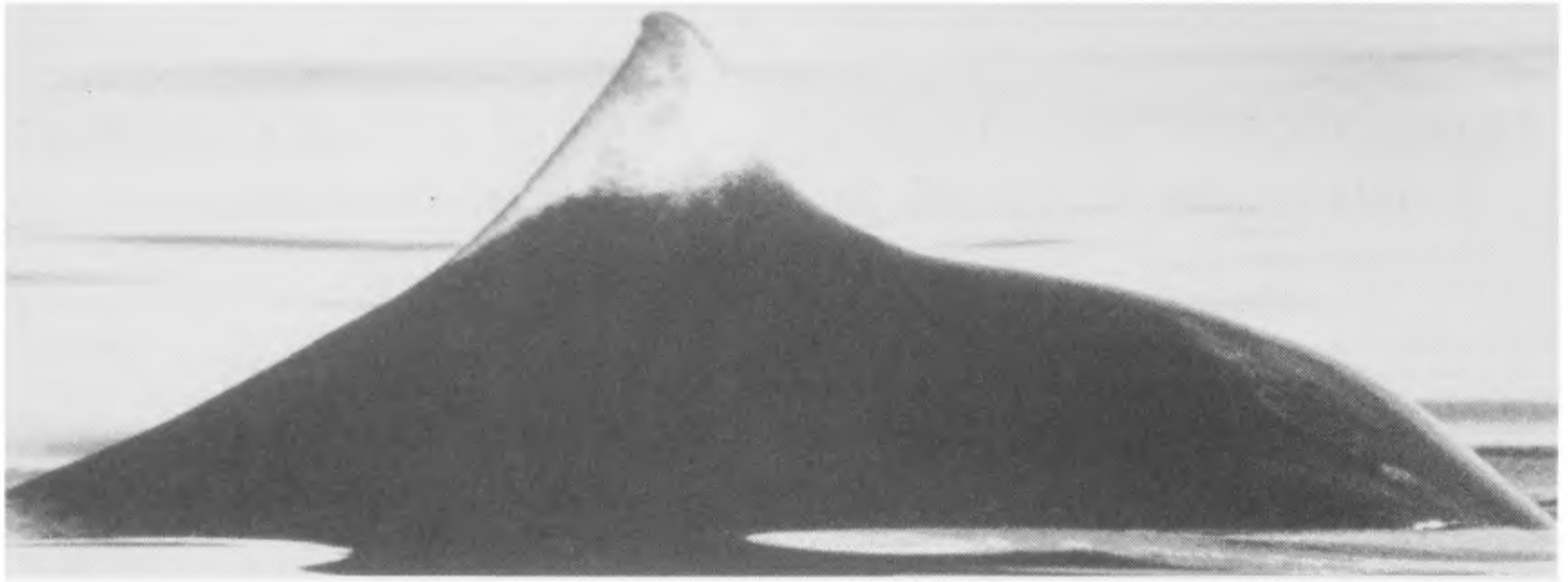

Fig. 1. Identification photograph of the dorsal fin of a Dall's porpoise in Puget Sound, Washington showing white frosting and black flecking pigment.

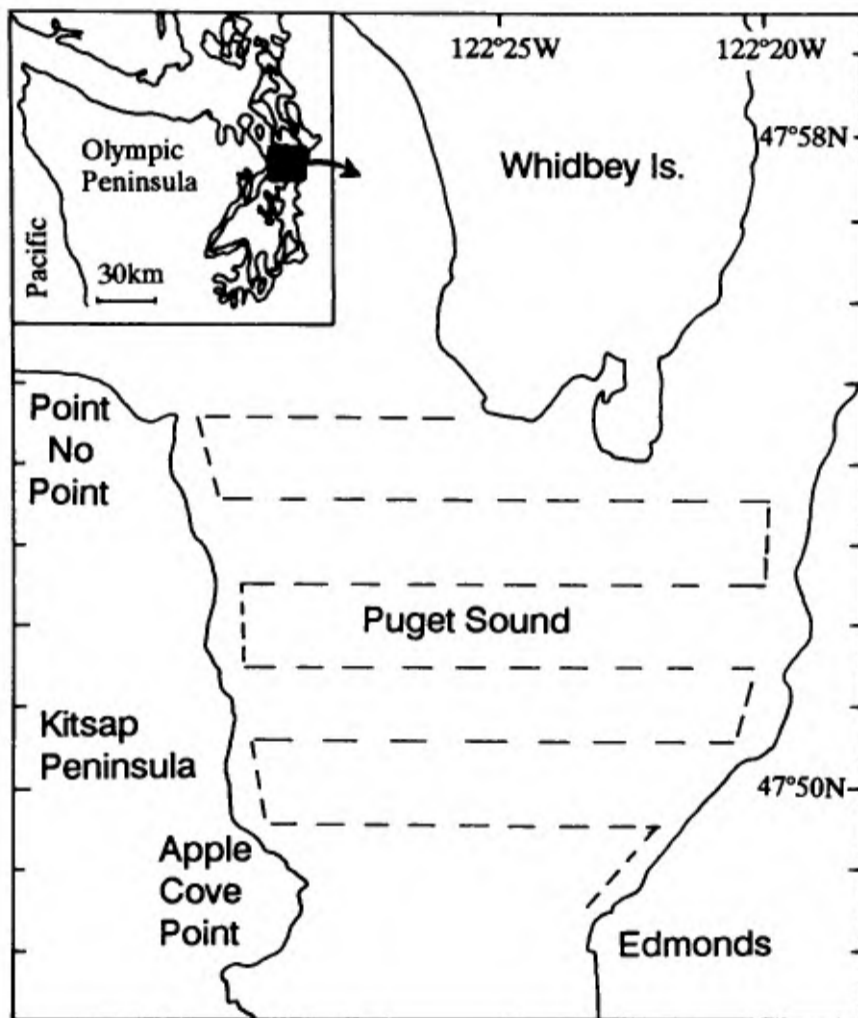

Fig. 2. Map of the Dall's porpoise study area and transect route in Puget Sound, Washington.

site; the total distance covered was approximately 24.8km per survey (Fig. 2). Surveys were run at approximately 7.5 km/hr, and were performed every 7–10 days, from June 1987 through May 1988.

Photographs of slow-rolling porpoises were taken during focal animal sampling. As many animals as possible were photographed in each aggregation. Photographs were taken of either side of the porpoises. Photographic sampling was most intense from 7 May to 7 October 1987; this interval is defined as 'the period of maximum effort'.

A 35mm *Olympus* OM-1 camera equipped with a power-winder was used with either a 300mm telephoto lens or an 80–200mm zoom lens. *Kodak* Tri-X and T-MAX films were used and developed at 400 ASA with a shutter speed of 1/1000sec. Time, position, number of animals

present, weather conditions and sea state were recorded every 15 minutes. Positions were obtained from a *Sea Ranger* ASB 2001 Loran C.

Analysis of photographs

Contact prints were made for all exposed film. Only photographs of sufficient quality for individual identification were enlarged for further analysis. Photographs that suffered from bad light conditions, extreme distance to the animals, improper angle to the dorsal fin or poor focus were not enlarged.

Individual porpoises were classified by the shape and pigmentation patterns of the dorsal fin. Dorsal fin characteristics were coded according to shape, white frosting, nicks and black pigment (including black flecking where distinguishable) (Fig. 3). If a photograph was not distinct enough to receive a code for all four dorsal fin characteristics, it was excluded from the analysis.

Shape	triangle 1	point 2	round 3	falcate 4	right 5	left 6	other O	
White	flat 1	S 2	trail 3	tip 4	S. tip 5	other O		
Nicks	lead high 1	lead low 2	trail high 3	trail low 4	none O			
Black	none 1	tip 2	trail 3	bottom 4	5	6	7	other O

Fig. 3. Dorsal fin characteristics used for the analysis of individual Dall's porpoises.

The photographs were sorted into similar groups according to the coded characters, and then sorted for more subtle differences in coloration by eye. Both the coding and the sorting are vulnerable to subjective decisions. Identified porpoises received an identification number preceded by a code, L (left) or R (right), indicating

which side of the animal was photographed. Left-side and right-side photographs could not be matched to a single animal.

Data analysis

Photo-identification

The feasibility of using photo-identification techniques on Dall's porpoise was evaluated in terms of effort (the amount of film used) and yield (the number of animals identified). Three statistics were calculated: percent identification success, mean number of identifications obtained in an encounter and the percentage of porpoises identified in the study.

Percent identification success (number of photographs of sufficient quality to identify an animal/ total number of photographs taken), is a measure of the proportion of identifiable images collected relative to the amount of film used. Percent identification success was calculated for each encounter during the period of maximum effort. The relationship between percent identification success and encounter length was quantified using a Spearman's rank correlation coefficient, (ρ). Computations were made according to Zar (1984) with a correction for ties in the ranked data.

The mean percentage of identification photographs obtained in an encounter was calculated by dividing the total number of identifications obtained of either side of the animals by the total number of possible identifications in that encounter, and averaging that proportion over all encounters in which photo-identification was attempted.

$$\text{Mean \% ID/encounter} = \sum_{i=1}^E [(L_i + R_i)/2n_i]/E * 100$$

where:

L_i = the number of left-side identifications in an encounter

R_i = the number of right-side identifications in an encounter

n_i = the number of porpoises present

E = the number of encounters.

The percentage of animals identified in the study was calculated for all encounters in which photo-identification was attempted. Since left-side and right-side identifications could not be matched to a single animal, there were potentially two identifications for each individual, one for each side. To account for this the percentage is presented as a range. The lower bound is calculated for the minimum number of animals potentially identified, assuming that each of the animals identified from the right side is also represented in the catalog of left-side identifications. The upper bound assumes that all of the photographs in the catalog of identifications, regardless of side, are of different animals:

$$\text{Lower bound} = \sum_{i=1}^E [\text{Max}(L_i, R_i)] / \sum 2n_i * 100$$

$$\text{Upper bound} = \sum_{i=1}^E [(L_i + R_i) \leq n_i] / \sum 2n_i * 100$$

Abundance estimates

Abundance was assessed using direct counts of identified individuals, sightings per unit effort (SPUE), and mark-recapture methods. Monthly direct counts are simply the number of individuals photographically identified in a given month. Sightings per unit effort was calculated

monthly, as the mean number of encounters per transect survey (24.8km). This index reflects the relative number of groups present in the site per month. SPUE was calculated for all months in which transect surveys were performed.

Monthly mark-recapture estimates of abundance, based on photo-identified individuals (marks) and resightings of identified individuals (recaptures), were calculated using the method of Manly and Parr (1968). This method applies to open populations with mark releases throughout the sampling period. Corrections for small sample sizes were applied (Seber, 1982). Sightings from outside the study area were excluded from mark-recapture analyses. Estimates of abundance and 90% confidence limits were calculated using left-side data only, with resightings pooled for each month. Right-side data were not used because there were no resightings during the first three sampling periods. Mark-recapture estimates of abundance were obtained for June 1987 through May 1988.

Analysis of group structure

Many terms have been used to describe the aggregations of social animals (e.g. herd, school, group, flock). This confusion of terms is particularly problematic for Dall's porpoise as their social structure has not been adequately defined as to the extent of the cohesion or stability in a group. For this study, I used the term 'group' to identify an aggregation i.e. the total number of animals present, including sub-groups that join or break off from the original group. Each aggregation was assigned an encounter number.

A coefficient of association (COA) is an index of the stability of the groups of Dall's porpoise. A COA was calculated for all pairs of animals that were seen together more than once. Left-side identified animals were compared with other left-sides, and right-side identified animals were compared with other right-sides. The co-occurrence of animals as pairs was evaluated by encounters and by days (pooling encounters that occurred on the same day), to investigate the possibility that animals encountered at different times on a single day were part of a single group. A coefficient of association is calculated as a ratio of the frequency of occurrence of a particular pair of animals and the frequency of occurrence of each animal in the pair (Pielou, 1977; Schaller, 1972; Heimlich-Boran, 1986):

$$\text{COA} = 2J/(a+b)$$

where: J = the number of times that porpoise A and porpoise B were seen together as a pair

a = the total number of times that porpoise A was sighted

b = the total number of times that porpoise B was sighted.

The COA can range from 0.00 for two porpoises that were never seen together to 1.00 for a pair that was always seen together. Since all of the animals in each group were rarely identified, the results underestimate the stability of the associations of the porpoises.

A coefficient of variation is a measure of the relative variability of the size of the groups in which an individual was sighted. The coefficient of variation was calculated for the group sizes in which each resighted individual was observed. Calculations were made using the method of Zar (1984), and multiplied by 100% so that the relative variation in observed group size is expressed as a percentage.

Straight line distances were calculated between the positions of resighted individuals to investigate the movements and range of the porpoises. Since 1° of latitude is not equal to 1° of longitude in the study area, longitude values were converted to the latitude scale for the area. Distance was calculated as the length of the hypotenuse of a right triangle drawn between the two sighting points, and converted to kilometers (km). Movements were analyzed without regard to the time passed between resightings.

RESULTS

Photo-identification

Photographs were taken on 37 of 69 days (54%) of focal animal sampling effort. A total of 1,134 photographs of slow-rolling porpoises were taken, 500 of which were enlarged. A total of 235 photographs (21% of the total amount of film used) were coded in all four dorsal fin characteristic categories. Individual porpoises were identified in 132 photographs; repeat identifications from within a single encounter were not included. Seventy-one fins were distinguished based on unique pigmentation patterns and shapes, however this does not imply that 71 different porpoises were identified. Identification photographs were collected from the left side of 39 animals and from the right side of 32 animals. Some of the individuals identified from the right side of the fin may also have been identified from the left side, therefore, at least 39 different animals were identified. The identified sample includes eleven uniquely shaped fins and one grey Dall's porpoise (Fig. 4).

The rate at which new individuals were identified is depicted in Fig. 5. The total number of identified individuals increased rapidly between 30 April and 31 September when photographic effort was heaviest. The rate decreases after the period of maximum effort, indicating that most of the identifiable animals using the area had been catalogued. New individuals were continually observed over the study period.

Percent identification success ranged from 0.00 to 0.79 (mean=0.26, SE=0.03, n=68). There was no indication that practice was affecting the rate at which identification photographs were collected. Percent identification success was positively correlated with encounter length (Spearman's $\rho = 0.76$, $p < 0.001$).

An average of 23% of the possible identifications in an encounter were obtained. The percentage of porpoises identified in the study is presented as a range because there are potentially two identifications for each animal, one from each side. If each of the porpoises identified from the right was also identified from the left, then only 17% of the animals photographed were photo-identified. However, if all of the identifications made from the right and all of the identifications made from the left are actually different animals than 21% of the porpoises photographed were successfully photo-identified.

Abundance

Based on direct counts alone it is correct only to say that between 39 and 71 animals used the area during the 13 month study (Table 1). The largest number of animals were photo-identified in August 1987. No porpoises were photo-identified in March 1988.

Monthly SPUE, the mean number of encounters per set of transects, are presented in Table 1. SPUE was highest in June (3.3) and lowest in March and April (0.5 for both months).

Monthly mark-recapture estimates produced by the Manly-Parr method and the approximate 90% confidence limits for the estimates are presented in Fig. 6. Monthly direct counts served as lower confidence limits when they exceeded the calculated lower bounds. The Manly-Parr method yielded a maximum estimate for August and a minimum estimate for March.

Group composition and stability

Twenty-three of the animals photographed from the left-side and 13 photographed from the right-side, (59% and 41% of the identified sample respectively), were

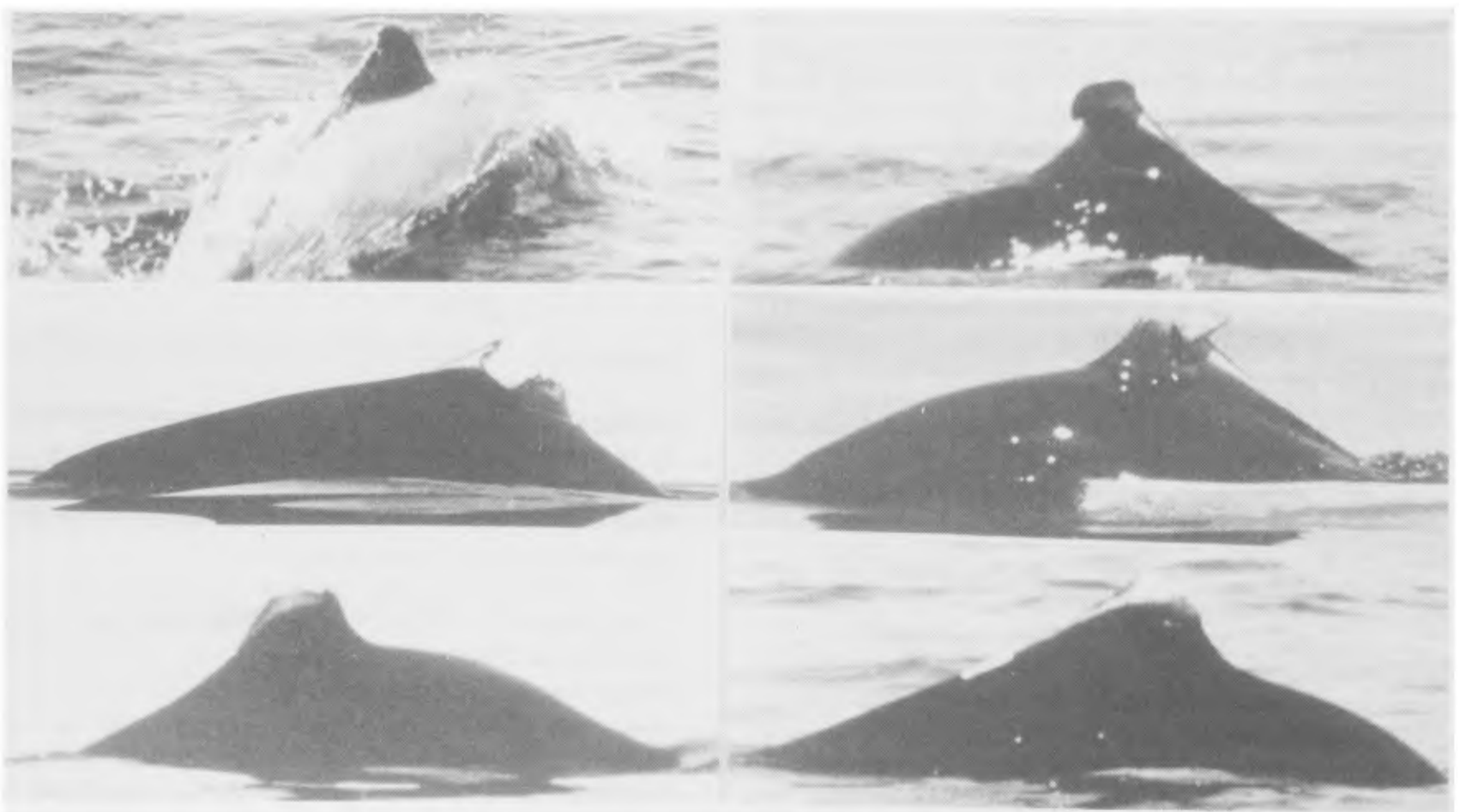

Fig. 4. Some unique dorsal fins of Dall's porpoises observed in Puget Sound, Washington (photos by the author).

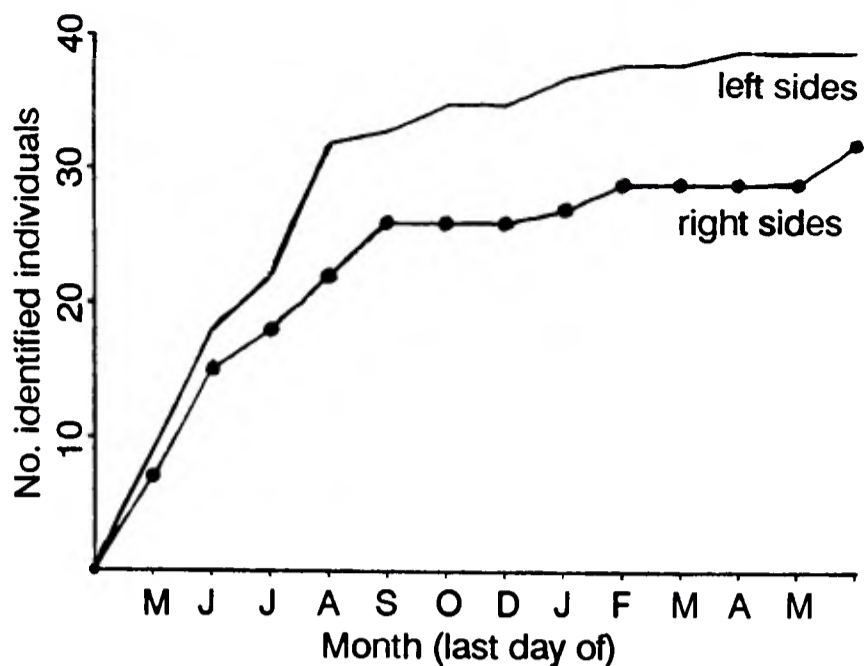

Fig. 5. The number of identified Dall's porpoises from Puget Sound, Washington, 1987-1988.

sighted more than once. Resightings were uncommon, the most frequently observed animal (L13), was seen only five times during the 13 month study period. The mean number of sightings per identified individual was 1.8, (range=1 to 5, SE=0.1, n=71). Mean time between resightings, calculated for the period of maximum effort, for both left and right sides combined was 49 days (left: mean=46 days, range=2 to 113, SE=8.1, n=17; right: mean=52, range=3 to 139, SE=9.8, n=13).

A summary of the associations of the identified animals in the study site is presented in Table 2. There were 561 possible combinations for pairs of individuals identified by the right side of the fin, and 741 possible combinations for pairs of individuals identified by the left side of the fin. Only four pairs of porpoises (0.3%), seen either during the same encounter or during the same day, had a COA greater than zero. This indicates that there is little stability in the associations of Dall's porpoise. However this index is underestimated because only 23% of the identifications in an encounter were collected.

Table 1

Sampling totals, direct counts of identified individuals, sightings per unit effort and mark-recapture estimates for Dall's porpoise in Puget Sound, Washington 1987-1988.

Month	Total Hours	Encounters	Direct Counts	Transect Surveys	SPUE	Manly-Parr
May	16.7	5	9	0	-	-
June	37.7	14	9	3	3.3	59
July	26.6	18	8	4	1	26
August	28.3	15	15	4	2.5	79
September	26.7	11	4	4	2.5	14
October	6.7	3	5	1	1	26
December	6.9	3	1	1	2	15
January	20.5	8	2	4	1.75	23
February	16.5	4	4	2	2	29
March	15.7	4	0	4	0.5	5
April	11.5	2	1	2	0.5	11
May	7.5	4	3	2	2	11
June	4	2	2	0	-	-

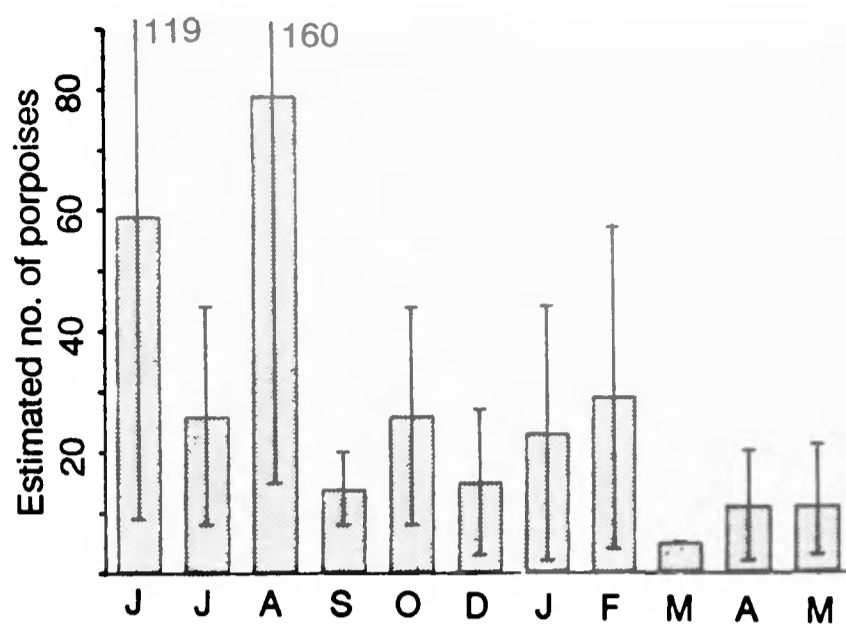

Fig. 6. Monthly mark-recapture estimates of abundance and 90% confidence intervals for Dall's porpoise in Puget Sound, 1987-1988. Estimates are calculated from Manly and Parr (1968).

Of the animals seen more than once, 81% were observed with varying numbers of other animals. The mean CV of observed group sizes was 29.4% (range=0 to 87%, SE=3.9, n=36). For the small group sizes observed in this

Table 2

Summary of associations among identified Dall's porpoises. Numbers in brackets refer to porpoises identified within an encounter with the individual; numbers not in brackets refer to other porpoises identified on the day that the individual was encountered.

ID #	Associated individuals
* L1	(4, 13), (3, 8)
L2	(14, 15, 30, 32, 34), (17, 27), 12
L4	(1, 13), 14, 25, 35, 22
L6	(5, 11, 19, 29), (26, 27)
L7	(8, 10, 13, 31)
L8	(13), (7, 10, 13, 31), (37)
L9	(18, 29), (13, 28)
L11	(5, 6, 19, 29), (19)
L13	(1, 4), (18, 24, 26), (9, 28), (7, 8, 10, 31)
L14	(2, 15, 30, 32, 34), (4), 22, 25, 35
L15	(2, 14, 30, 32, 34), (20, 21, 33)
L18	(9, 29), (13, 24, 26)
L19	(5, 6, 11, 29), (11)
L21	(16), (15, 20, 33)
L22	(25, 35), 4, 14
L29	(5, 6, 11, 19), (9, 18)
L35	(22, 25), 4, 14, 23
L24	(13, 18, 26), (30, 33, 39)
L26	(13, 18, 24), (6, 27)
L27	(2, 17), (6, 26)
L30	(2, 14, 15, 32, 34), (24, 33, 39)
L33	(15, 20, 21), (24, 30, 39)
L37	(38), (8)
** R5	(12, 23), 17, 24, 4
R6	(9, 11), 14, 19, 25, 27, (3, 22, 26), 15
R10	(24)
R11	(9, 6), 14, 19, 25, 27, (19)
R12	1, 16, (5, 23), 17, 24, 4, (19), 15, 16
R13	(28), (7, 23), (8)
R14	(19, 25), 27, 6, 9, 11
R15	(18, 20), 3, 6, 22, 26
R16	(1), 12, (15), 12, 19
R19	(14, 25), 27, 6, 9, 11, (11), (12), 15, 16
R23	(7, 13), 28, (5, 12), 17, 24, 4
R24	(10), (4, 17), 5, 12, 23, (29, 30, 31, 32)
R31	(24, 29, 30, 32)

* Left-sides compared only with other left-sides.

** Right-sides compared only with other right-sides.

Table 3

Group sizes and coefficients of variation (CV) for resighted individual Dall's porpoises.

ID #	No. present	CV	ID #	No. present	CV
L1	3, 5, 5	26.6	L26	4, 5	15.5
L2	16, 5	74.0	L27	5, 5	0
L4	3, 5	35.3	L30	16, 6	64.2
L6	5, 5, 5	0	L33	5, 6	12.8
L7	8, 5	32.6	L37	4, 8	47.1
L8	5, 5, 8	28.8	R5	4, 4	0
L9	5, 3	35.3	R6	5, 5, 3	26.6
L11	5, 3	35.3	R10	5, 4, 5	12.3
L13	3, 4, 3, 5, 5	25	R11	5, 5	0
L14	16, 5	74.0	R12	3, 4, 4	15.7
L15	16, 5	74.0	R13	9, 3, 7	48.2
L18	5, 4	15.7	R14	3, 4	20.2
L19	5, 3	35.2	R15	16, 5, 4, 3	86.5
L21	5, 5	0	R16	5, 5, 3	26.6
L22	5, 3	35.2	R19	5, 5, 5	0
L29	5, 5	0	R23	3, 4	20.2
L35	5, 6, 7, 5	16.6	R24	4, 3, 5, 8	43.2
L24	4, 6	28.2	R31	4, 8	47.1

study (Table 3), this indicates that individuals tended to be associated with aggregations of fairly constant size. A summary of the group sizes in which identified individuals were observed is presented in Table 3.

The mean distance between resightings was 5.40km (range=0.7 to 17.7km, SE=0.4, n=51). Porpoise R13 was originally photographed approximately 18km north of the main study site and was seen again in the main site on two occasions. Porpoise L21 was photographed at Bush Point, approximately 13km northwest of the main site, as well as in the main study site.

DISCUSSION

Photo-identification

Although many Dall's porpoises were successfully photo-identified, several problems, some of them unique to the species, were encountered. These difficulties were both behavioral and morphological.

The biggest obstacle to the photo-identification of Dall's porpoise appears to be getting high quality photographs of the dorsal fin – only 21% of the photographs obtained in this study were suitable for identifications. Dall's porpoise are small so they are difficult to see, and the dorsal fin presents a small target to photograph relative to the some of the other cetaceans that are commonly photo-identified. In addition, the surfacing pattern of Dall's porpoise is variable, and the dorsal fin comes up early in the surfacing arc, making it difficult to photograph.

Identification photographs can only be taken while the porpoises are slow-rolling, since Dall's porpoise produce a rooster-tail splash when swimming fast or bow-riding. In many areas the rooster-tail swimming mode predominates (Bouchet, Braham and Tsunoda, 1983); in the inshore waters of Puget Sound rooster-tailing was observed in 36% of encounters (Miller, 1987). Since encounter length and percent identification success are correlated, the best way to get identification photographs is to follow the animals for as long as possible.

In this study porpoises were identified by the gross white pattern of the frosting of the dorsal fin, and the shape of the fin. Based on investigations of dead specimens, Jefferson

(1986) suggested using the black flecking pattern on the white frosting to identify individuals, however it is difficult to obtain enough photographs of sufficient quality to analyze. In addition, placing emphasis on the flecking character may result in missed matches when there is poor resolution of the flecking due to varying light conditions or photographic processing methods.

The number of animals in the population that have unique pigmentation patterns or other identifiable features is not known. While some Dall's porpoises in the study area have distinct markings, it is likely that a proportion of the population cannot be identified. The rapid decrease of new identifications, after only five months of sampling (Fig. 5) indicates that some fraction of the population is 'unidentifiable'. Alternatively, the change in rate might indicate that all of the animals using the area have been identified. Behavioral differences between individuals, such as the tendency of some animals to approach boats (Bouchet *et al.*, 1983), might also cause the rate of identifications to decrease after those more 'catchable' animals were identified.

The differences between individual Dall's porpoises are often subtle and while dorsal fins can be distinguished in a photograph, it is difficult to keep track of individuals in the field unless they have exceptionally clear features. In this study, 11 unusually shaped fins were identified (Fig. 4). Some of these fin shapes appear to be the result of a cut, perhaps from a boat propeller. The animals with unique fins constituted 15% of the identified population in the study site. It is not known if these misshaped fins are common in other areas, or if their abundance is correlated with boat traffic. These fins are easier to identify than porpoises with normal fins, so photographic effort may have been biased towards them.

The only report of a Dall's porpoise with a misshaped fin from another area is that of a sighting of a Dall's porpoise with a 'chopped off dorsal fin' from Monterey Bay, California (Loeb, 1972). Sightings of grey Dall's porpoises have been reported from Monterey Bay, California (Morejohn *et al.*, 1973), and Prince William Sound, Alaska (Hall, 1981).

Abundance

Direct counts, SPUE, and mark-recapture analysis yielded monthly estimates of the abundance of Dall's porpoise in the study area (Table 1). However, interpretation of the results is confounded by the effects of small sample size, inconsistent sampling effort and problems associated with the behavior of the animals. In addition, these procedures pertain to an open population, one that most likely covers an area much larger than the study site. While it is possible that all of the animals in that population are randomly passing through the study site, it would be inappropriate, given the limitations of the sampling design, to extrapolate from these results to any other area of Puget Sound.

Although the direct counts are based on the fewest assumptions, they are highly dependent on sampling and photographic effort. Similarly, the accuracy of the mark-recapture estimates differs between periods, being based on sampling effort and numbers of resightings (Seber, 1982). Since SPUE includes sampling intensity, and it is less restricted than the mark-recapture model, being bound by fewer assumptions, it may be the best of the three measures presented.

Maximum values for the three methods occurred in summer (August for the direct counts and the Manly-Parr, and June for SPUE), and minimum values occurred in spring (March for the direct counts and the Manly-Parr, March and April for SPUE).

Direct counts of identified individuals provide the lowest estimates of local abundance. The total number of animals present could be overestimated by the direct counts however, if matches to identified individuals were frequently missed. Conversely, an underestimate could occur if the number of animals in an area is large, photographic effort is small, and residency time is short and/or variable, as is probably the case for Dall's porpoise in the study area.

SPUE provides an index of relative monthly abundance not an estimate of total abundance. Although the SPUE exhibit a different monthly trend to mark-recapture estimates, the seasonal averages (spring, summer, winter, fall) are similar. It may be more accurate to pool transect surveys over seasons rather than months to increase sample sizes for SPUE.

The problems of small sample sizes and inconsistent effort are also reflected in the Manly-Parr estimates as well. Seber (1982) recommends that in each period the numbers of recaptures should be greater than 10 if the estimates are 'to give even the order of magnitude of the true population size'. Manly (1970) investigated the effects of small sample sizes and found the Jolly-Seber method (Jolly, 1965; Seber, 1965) to be consistently better than the Manly-Parr method, however it is not clear whether the small sample size formulas described in Seber (1982) were applied. The Jolly-Seber method was also attempted for these analyses, however because of problems with the estimates and the variance formulae the results were not included.

The specific application of mark-recapture methods to populations of whales is discussed by Hammond (1986; 1990). Some of the underlying assumptions of the Manly-Parr method are particularly problematic with respect to Dall's porpoise and warrant further discussion. These assumptions deal with the permanence of identifying marks, the accuracy of mark reporting and equal catchability.

There are as yet insufficient data to consider the persistence of the markings of Dall's porpoise. There is some indication that the color patterns of Dall's porpoise change as the animals mature (L. Jones, National Marine Mammal Laboratory, NMFS, Seattle, WA., pers. comm.). Relative to the short-term nature of this study, however, the markings of Dall's porpoise are assumed to be permanent. Research on the permanence of natural marks on other odontocetes indicates that natural markings can be quite durable over time (e.g. see review by Würsig and Jefferson, 1990).

The possibility of missing matches or inaccurately matching different individuals was not directly evaluated for this study; however, the selection of only 'codable' photographs for the analyses should reduce the problem by choosing only the best quality photographs for matching. Carlson, Mayo and Whitehead (1990) and Perry, Baker and Herman, (1990) discuss this problem with respect to humpback whales.

Unequal catchability may be a serious problem for Dall's porpoise in Puget Sound. The high proportion of misshaped fins observed in the study area may be reflective of a heterogeneity of capture probabilities. In addition, the

inconsistent nature of the resighting histories, many of which include long periods between sightings (mean time between resightings=49 days), may be indicative of temporary immigration. If individual porpoises are moving in and out of the study site, the probability of a resighting is not constant between periods.

In spite of the stretched assumptions, mark-recapture estimates were obtained for all months. For the reasons outlined above, the accuracy of the estimates as a measure of absolute population size is questionable. However they might provide an index of relative abundance.

Despite intensive sampling effort during several months, the sampling intensity was inconsistent, and due to the low numbers of resightings all of the estimates are based on small sample sizes. In addition, the estimates may be subject to the effects of temporary immigration, tidal phase, or other factors. In this light, the discussion of the abundance of Dall's porpoise presented here should be viewed as an exploration of procedures.

Social structure

The conclusions relating to the social structure of Dall's porpoise are especially vulnerable to the problems associated with the photo-identification of Dall's porpoise and small sample sizes. There was no resident group of porpoises in the study area during the 13 months of the study. However, some individuals were seen in the area repeatedly and may be resident to Puget Sound. Due to the low proportion of animals that were identified it is difficult to assess the stability of the groups of Dall's porpoise. However, identified individuals were found to travel in fairly constant group sizes.

Residency

Dall's porpoise have been described as resident to Puget Sound being observed in all months of the year (Everitt *et al.*, 1980). The inconsistent nature of the sampling design however, limits the conclusions that can be made regarding residency in the study area. Although porpoises were seen in all months of the study, no porpoises were observed permanently or even consistently enough in the study area to be considered resident. This is supported by the continual identification of new individuals in the study area which may be indicative of a transient population.

The mean of 49 days between resightings of individuals is also reflective of individual movements, (although inconsistent sampling would tend to overestimate this as well). Several identified animals were seen repeatedly over the 13 month study while others were seen only briefly or never again after an initial encounter. On several occasions groups were followed out of the study area, and two individuals that were identified inside the study site, were resighted in other areas of Puget Sound. Although periods of consecutive days of focal animal sampling occurred there were no resightings on consecutive days.

The extended time and range of movement between resightings and the relative infrequency of resightings are indicative of frequent movements into and out of the study site. It is likely that there are several areas in Puget Sound where Dall's porpoise aggregate, and that movements within Puget Sound occur daily.

Group stability

The definition of terms in the literature relating to the social structure of Dall's porpoise is inconsistent. Kasuya (1978) suggested that the basic unit of a Dall's porpoise

'school' is 2-3 animals, and that larger groups are actually aggregations of these units. However, Jones, Bouchet, Rice and Wolman (1984) described groups of 20 or more individuals traveling in spread-out formation and cautioned against counting these as several small groups.

The groups of Dall's porpoise may be fluid, similar to the structures described for *Tursiops truncatus* (Würsig and Würsig, 1977), *Stenella longirostris* (Norris and Dohl, 1980), and *Sousa sp.* (Saayman and Tayler, 1979). The associations between pairs of Dall's porpoises revealed low numbers (0.3%) of animals traveling with consistent companions. However considering the low proportion of identifications in an encounter (23%), it is possible that the same porpoises were actually present and were not identified. While the analysis of COA by left and right sides separately, prevents the problem of accidentally associating individuals with their opposite side, it also under-represents associations between other individuals identified from different sides.

Four pairs of animals were found to be associated. Two of those pairs were observed together, during two independent encounters, and two pairs of porpoises co-occurred on two separate days. One of the four pairs appeared to be a cow-calf pair (based on the relative size and proximity of the two individuals). Groups with calves were difficult to approach and photograph so cow-calf associations are underestimated in this index.

The size of the groups in which an individual was observed, varied little and might even be due to counting errors. This result agrees with Loeb (1972) who observed unique animals traveling in 'fairly constant' group sizes.

CONCLUSIONS

It appears that photo-identification methodology can be applied to Dall's porpoise studies. However its suitability must be considered in terms of the time and energy required to get photographs. The scope of the results, especially with respect to the estimation of abundance, is limited by the number of good quality photographs that are available within a workable time frame.

Since the accuracy of mark-recapture methods is dependent on the numbers of resightings, the use of those methods may be better suited for large scale studies. While small sample mark-recapture estimates may be useful for looking at trends in population abundance, the effect of the small sample correction factor and the accuracy of the variance estimates should be examined. For any longer-term study, the question of the permanence of the markings must be investigated.

Long term application of photo-identification techniques could provide information concerning the abundance, and population stability of the Dall's porpoise through direct counts of identified individuals. The initiation of a catalog of identified individuals in Puget Sound provides a starting point for more detailed studies of the behavior, group structure and the seasonal movements of Dall's porpoises.

ACKNOWLEDGMENTS

I would like to thank the members of my degree committee at the University of Washington, Christine Ribic, Linda Jones and Gary Thomas, who have been both helpful and patient. Fred Felleman, Robert Reavis, Bill Rugen and many others assisted with data collection. Fred Felleman

contributed identification photographs. Sally Mizroch provided many helpful suggestions and general encouragement. John Hedgepeth helped calculate the distances between sighting locations. Funding for the study was contributed by the National Marine Mammal Laboratory, (NMFS, NOAA), Seattle, Washington; the Washington Cooperative Fishery Research Unit, the School of Fisheries and the Graduate School at the University of Washington. I am grateful also to *Sea Ranger Marine Electronics* for donating an ASB 2001 *Loran C* to the study. E. Cupp contributed many hours of editing and discussion. Earlier drafts of the manuscript were critically reviewed by J. Skalski (Center for Quantitative Science, University of Washington, Seattle WA 98195); and by L. Jones, T. Loughlin and D. Rugh (National Marine Mammal Laboratory, NMFS, 7600 Sand Point Way N.E., Seattle, WA 98115). This is contribution no. 815 of the University of Washington, School of Fisheries, Seattle, WA 98195.

REFERENCES

- Altman, J. 1974. Observational study of behavior; sampling methods. *Behaviour* 49: 227-67.
- Bouchet, G.C., Braham, H.W. and Tsunoda, L.M. 1983. Investigation of Dall's porpoise (*Phocoenoides dalli*) response to a survey vessel: Preliminary assessment. Paper SC/35/SM13 presented to the IWC Scientific Committee, June 1983 (unpublished). 15pp.
- Carlson, C.A., Mayo, C.A. and Whitehead, H. 1990. Changes in the ventral fluke pattern of the humpback whale, *Megaptera novaeangliae* and its affect on matching: evaluation of its significance to photo-identification research. Paper SC/A88/ID35 (published in this volume).
- Everitt, R.D., Fiscus, C.H. and DeLong, R.L. 1980. Northern Puget Sound Marine Mammals. Report prepared for the MESA Puget Sound project, DOC/EPA Interagency Energy/Environ. R&D Program. EPA-600/7-80-139, US Environmental Protection Agency, Washington D.C. 134pp.
- Hall, J.D. 1981. Aspects of the natural history of cetaceans of Prince William Sound, Alaska. Ph.D. dissertation University of California, Santa Cruz. 148pp.
- Hammond, P.S. 1986. Estimating the size of naturally marked whale populations using capture-recapture techniques. *Rep. int. Whal. Commn* (special issue 8):253-82.
- Hammond, P.S. 1990. Heterogeneity in the Gulf of Maine? Estimating humpback whale population size when capture probabilities are not equal. Paper SC/A88/ID4 (published in this volume).
- Heimlich-Boran, S.L. 1986. Cohesive relationships among Puget Sound killer whales. pp. 251-84. In: B.C. Kirkevold and J.S. Lockard (eds.) *Behavioral Biology of Killer Whales*. Zoo Biology Monographs. Vol.1. Alan R. Liss, New York. 457pp.
- International Whaling Commission. 1990. Report of the Workshop. (Published in this volume).
- Jefferson, T.A. 1986. External indicators of age and sex in Dall's porpoise (*Phocoenoides dalli*): preliminary report. Report submitted to the National Marine Mammal Laboratory, NMFS, NOAA. (Unpublished) 13pp.
- Jolly, G.M. 1965. Explicit estimates from capture-recapture data with both death and immigration-stochastic model. *Biometrika* 52: 225-47.
- Jones, L.L., Bouchet, G.C., Rice, D.W. and Wolman, A.A. 1984. Progress report on studies of the incidental take of marine mammals, particularly Dall's porpoise, by the Japanese salmon fisheries, 1978-1983. Document submitted to the *Ad Hoc* Committee on Marine Mammals, INPFC. 62pp.
- Kasuya, T. 1978. The life history of Dall's porpoise with special reference to the stock off the Pacific coast of Japan. *Sci. Rep. Whales Res. Inst., Tokyo* 30: 1-63.
- Loeb, V.J. 1972. A study of the distribution and feeding habits of the Dall porpoise in Monterey Bay, California. M.A. thesis, San Jose State College. 62pp.
- Manly, B.J.F. 1970. A simulation study of animal population estimation using the capture-recapture method. *J. Appl. Ecol.* 7: 13-39.

- Manly, B.J.F. and Parr, M.J. 1968. A new method for estimating population size, survivorship, and birth rate from capture-recapture data *Trans. Soc. Brit. Ent.* 18: 81-9.
- Miller, E. 1987. Preliminary observations of the distribution and behavior of Dall's porpoise (*Phocoenoides dalli*) in Puget Sound. Abstract presented to the Seventh Biennial Conference on the Biology of Marine Mammals, Miami, Florida.
- Morejohn, G.V., Loeb, V.J. and Baltz, D.M. 1973. Coloration and sexual dimorphism in the Dall porpoise. *J. Mammal.* 54: 977-82.
- Norris, K.S. and Dohl, T.P. 1980. The structure and function of cetacean schools. pp. 211-61. In: L.M. Herman (ed.) *Cetacean Behavior: Mechanisms and Functions*. Wiley and Sons, New York. 463pp.
- Norris, K.S. and Prescott, J.H. 1961. Observations on Pacific cetaceans of Californian and Mexican waters. *Univ. Calif. Publ. Zool.* 63: 291-402.
- Perry, A., Baker, C.S. and Herman, L.M. 1990. Population characteristics of individually identified humpback whales in the central and eastern North Pacific: a summary and critique. Paper SC/A88/ID25 (published in this volume).
- Pielou, E.C. 1977. *Mathematical Ecology*. Wiley Interscience, New York. 317pp.
- Saayman, G.S. and Tayler, C.K. 1979. The socioecology of Humpback Dolphins (*Sousa* sp.). pp. 165-226. In: H.E. Winn and B.L. Olla (eds). *Behavior of Marine Animals, Vol. 3: Cetaceans*. Plenum Press, New York. 438pp.
- Schaller, G.B. 1972. *The Serengeti Lion* University of Chicago Press, Chicago, Illinois. 480pp.
- Seber, G.A.F. 1965. A note on the multiple recapture census. *Biometrika* 52:249-59.
- Seber, G.A.F. 1982. *The Estimation of Animal Abundance and Related Parameters*. Charles Griffen and Co. Ltd. London and High Wycombe. 654pp.
- Silber, G.K., Newcomer, M.C. and Barros, G.J. 1988. Observations on the behavior and ventilation cycles of the Vaquita (*Phocoena sinus*). *Mar. Mamm. Sci.* 4(1): 62-67.
- Würsig, B. and Jefferson, T.A. 1990. Methodology of photo-identification for small cetaceans. Paper SC/A88/ID13 (published in this volume).
- Würsig, B. and Würsig, M. 1977. The photographic determination of group size composition and stability of coastal porpoises (*Tursiops truncatus*). *Science* 198: 755-56.
- Zar, J.H. 1984. *Biostatistical Analysis*. 2nd edition. Prentice Hall Inc., Englewood Cliffs, N.J. 718pp.

A Note on the Feasibility of Using Photo-Identification Techniques to Study the Baiji, *Lipotes vexillifer*

Hua Yuanyu, Zhang Xianfeng, Wei Zhuo and Wang Xiaoqiang

Institute of Hydrobiology, Academia Sinica Wuhan, People's Republic of China

ABSTRACT

Observations of living (wild and captive) individuals and of dead specimens demonstrate that the Baiji has natural marks that can be used in photo-identification. Approximately 1,000 photographs were collected in the course of three expeditions during the period from March 1986 to December 1987. Although these were not useful for individual identification this was the result of deficiencies in photographing technique and equipment. Further work is planned.

INTRODUCTION

The baiji (*Lipotes vexillifer*) is the most rare of the platanistoid river dolphins and is confined to the Yangtze River in China. Research into this severely threatened species (only 300 are thought to survive) began about ten years ago and has intensified as its precarious status was revealed (Perrin, Brownell, Zhou and Liu, 1989). Most studies on free-living dolphins have concentrated on population estimation, behaviour and habitat dependence; growth and reproduction have been studied using captive animals. The interested reader is referred to papers in Perrin *et al.* (1989) for information on these studies.

Over the last 15 years or so, photo-identification of individual animals has been revealed to be a powerful tool for examining the population biology of a number of cetacean species (IWC, 1990).

If the baiji is to be protected more effectively, more needs to be known about characteristics of the population such as birth rate, mortality, migration, home range and social structure. Development of photo-identification methods may allow this research to be pursued. This paper reports the results of work begun in 1986, to determine whether the method is appropriate for the baiji.

METHODS

The adult baiji is 2–3m long (Fig. 1). In some animals nicks and scars can be seen in the thin trailing edge of the dorsal fin (Fig. 2) and pigmented areas or scars can also be seen on the body. For example, Qi Qi, a captive male, bears two scars behind the blowhole inflicted by fishhooks during capture; these scars have remained constant in size and intensity for over eight years. Another animal (Zheng

Zheng) captive for two years bears a white spot near its blowhole that was caused by skin disease (Xu and Xiong, 1985). In addition, general pigmentation varies among individuals.

When a baiji surfaces, the beak and the top of the head appear first, followed by the dorsal fin and the back; occasionally the flippers emerge. Sometimes the dorsal fin remains visible briefly after the head is again submerged. The flukes usually do not break the surface. It was usually possible to photograph the dorsal fin and part of the back with a telephoto lens. We used 2–3 35mm cameras (one *Nikon FM-1*, two *Minolta X-300*) with lenses ranging from 80 to 200mm (one *Nikon* lens, two *Tokina* lenses). Shutter speeds were 1/250–1/500 sec. Most photographs were taken using *Kodachrome ASA 100* and 200 colour slide film, although ASA 100 black/white film was also used.

While searching for and observing dolphins, we used Chen's method (Chen and Hua, 1986). A research vessel and 4–8 small boats proceeded in a line abreast extending the width of the river. When dolphins were sighted, we either followed them at a distance of 150–200m or surrounded them and observed them at a distance of 50–150m.

RESULTS AND DISCUSSION

Three expeditions carried out in the Chenglingji section of the river between March 1986 and December 1987 resulted in about 1,000 photographs, taken on 10 of 70 days. We divided the photographs into five types: (A) head and back high out of the water and dorsal fin seen clearly (Fig. 4); (B) dorsal fin seen, but head and back indistinct (Fig. 5); (C) animal not clearly seen but distinguishable from finless

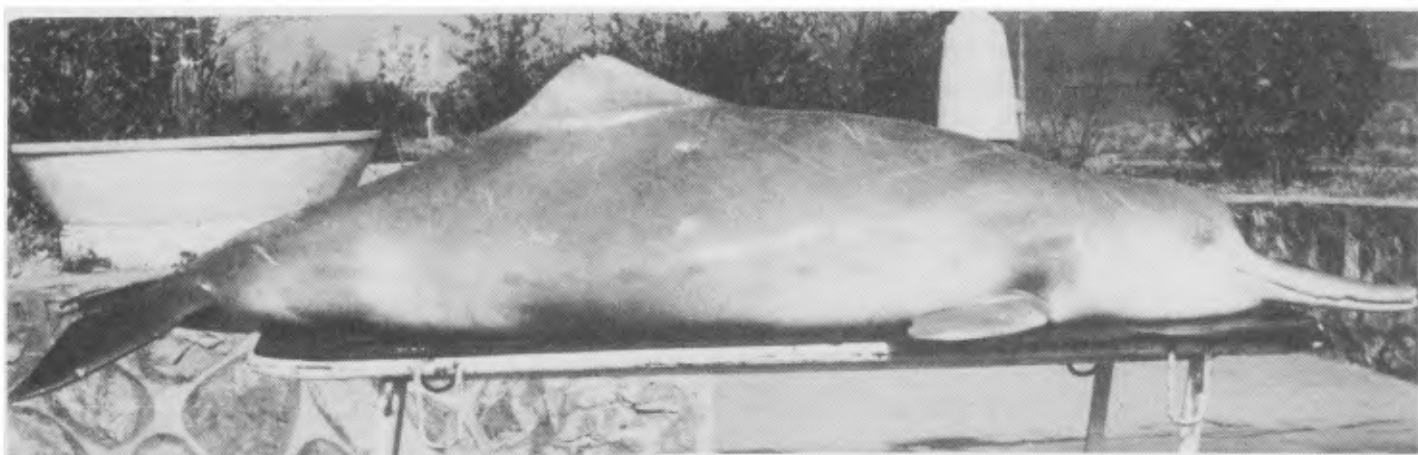

Fig. 1. A female baiji, 232 cm.

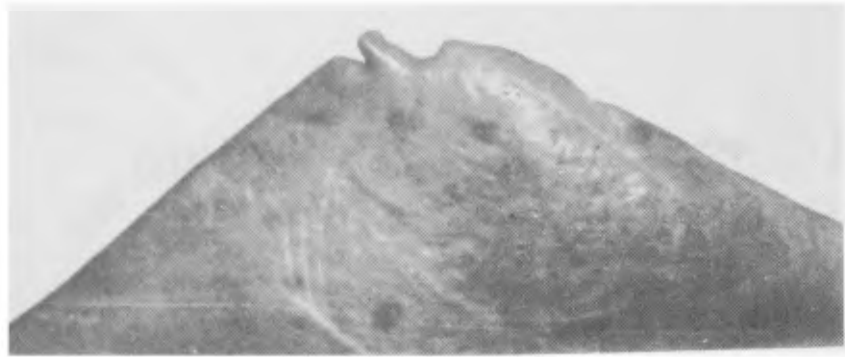

Fig. 2. Nicks in the dorsal fin of a baiji.



Fig. 3. Two light scars behind the blowhole of a captive baiji (Qi Qi).

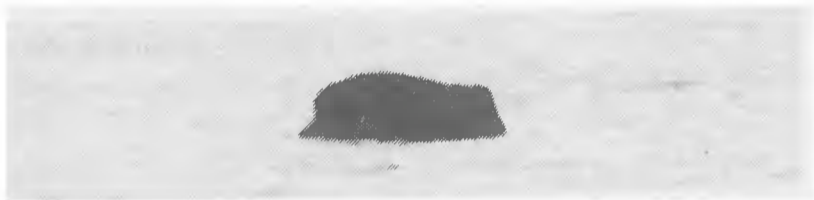

Fig. 4. Type A photograph of a baiji; head and back high above the surface.



Fig. 5. Type B photograph of a baiji; dorsal fin visible, but head indistinct.

porpoise, *Neophocaena phocaenoides*; (D) animal not clearly distinguishable from finless porpoise; and (E) failure (bad focusing or no dolphin image). The frequencies of the five types are given in Table 1.

Although no photographs were good enough to enable us to catalogue individuals with confidence, we believe this to be due to our inexperience and deficiencies in equipment rather than an intrinsic problem with the species. We have seen marks on free-ranging, captive and dead animals that, if adequately photographed under good conditions, would allow individual identification. For example, on 2 March 1987, when the weather was sunny and the river calm, we observed a group of 16 dolphins (possibly a temporary aggregation of two or more smaller groups) catching fish. The group included 6 large dolphins, 6 medium-sized individuals and 4 juveniles. We followed the group at a distance of 100–200m for more than 7 hours, once approaching within 50m, until the group was dispersed by a large passenger ship passing down the river. One dolphin had a distinct mark on the left side of the dorsal fin, but the mark was not visible in the photographs taken (Fig. 6). The same dolphin was seen in following days but was not successfully photographed.

Table 1

Types of photographs obtained from three expeditions, 1986–87.

Types	Distance(m)	Estimated number	Proportion (%)
A	50	80	8
B	100	400	40
C	150-200	300	30
D	200-300	150	15
E		70	7



Fig. 6. Baiji bearing distinct mark not visible in photograph.

In conclusion the baiji appears to be more difficult to photograph than some other dolphins that have been the subjects of photo-identification studies, because of its small size, the brief time that it spends at the surface, its 'shy' behaviour developed because of heavy traffic on the river and the opaqueness of the water that it inhabits. However other factors tend to favour it as a species for photo-identification; the groups are usually small, consisting of 2–6 dolphins and their home ranges are relatively stable at certain times of the year (Chen, Liu, Lin and Pilleri, 1980; Chen and Hua, 1989; Hua *et al.*, 1986). In future studies we will concentrate on maneuvering closer to the animals and will investigate the use of longer lenses.

ACKNOWLEDGEMENTS

We are grateful to He Chuhua and Zhang Guocheng for providing some of the photographs. We also wish to thank Chen Peixun and Liu Renjun for reading the manuscript and W.F. Perrin and Vera da Silva for giving kind comments. We thank Cetacean Society International and International Wildlife Coalition and B. Würsig for providing support that allowed one of us (Zhang Xianfeng) to attend the conference.

REFERENCES

- Chen, P., Liu, R., Lin, K., and Pilleri, G. 1980. The distribution, ecology, behaviour and protection of the dolphins in the middle reaches of Changjiang River (Wuhan-Yueyang). *Limnolog. Sin.* 11(1):73–84.
- Chen, P. and Hua, Y. 1989. Distribution, population size and protection of *Lipotes vexillifer*. *Occ. Pap. IUCN SSC No. 3*:81–5.
- Hua, Y., Zhao, Q. and Zhang, G. 1989. The habitat and behaviour of *Lipotes vexillifer*. *Occ. Pap. IUCN SSC No. 3*:92–8.
- International Whaling Commission. 1990. Report of the Workshop on Individual Recognition and the Estimation of Cetacean Population Parameters, La Jolla, 1–4 May 1988. (Published in this volume).
- Perrin, W.F., Brownell, R.L. Jr., Zhou, K. and Liu, J. (Eds.) 1989. Biology and Conservation of the River Dolphins. *Occ. Pap. IUCN SSC No. 3*:v+173pp.